



## PRINTING INSTRUCTION

1. File > Print
2. Click on “Page Setup” button make sure your paper size is set to the paper size that you will print and Scale at 100%
3. In “Pages Sizing & Handling” click on “Size” button and select “Actual size”

The image shows two screenshots of software dialog boxes. The left screenshot is the 'Print' dialog box, and the right screenshot is the 'Page Setup' dialog box. Red callout boxes with arrows point to specific settings in both dialog boxes.

**Print Dialog Box:**

- Printer:** FUJJI XEROX DocuPrint CM215 fw... Advanced
- Copies:** 1
- Print in grayscale (black and white):**
- Pages to Print:** All (selected), Current page, Pages 1-3
- Page Sizing & Handling:** Size (selected), Poster, Multiple, Booklet. Under Size, **Actual size** (selected), Fit, Shrink oversized pages, Custom Scale: 100%, Choose paper source by PDF page size.
- Orientation:** Auto portrait/landscape (selected), Portrait, Landscape.
- Buttons:** Page Setup..., Printer...

**Page Setup Dialog Box:**

- Settings:** Page Attributes
- Format For:** Any Printer
- Paper Size:** A4 (selected), 210 by 297 mm
- Orientation:** Portrait (selected), Landscape
- Scale:** 100% (selected)
- Buttons:** Cancel, OK

**Callout Boxes:**

- Select Actual size:** Points to the 'Actual size' radio button in the 'Page Sizing & Handling' section of the 'Print' dialog.
- Set the paper size:** Points to the 'Page Setup...' button at the bottom of the 'Print' dialog.
- Select the paper size:** Points to the 'Paper Size' dropdown menu in the 'Page Setup' dialog.
- Scale 100%:** Points to the 'Scale' input field in the 'Page Setup' dialog.

### IMPORTANT NOTE:

- **ADOBE ACROBAT READER (FREE SOFTWARE)** is recommended to open and print the patterns

link for free download

<https://get.adobe.com/reader>

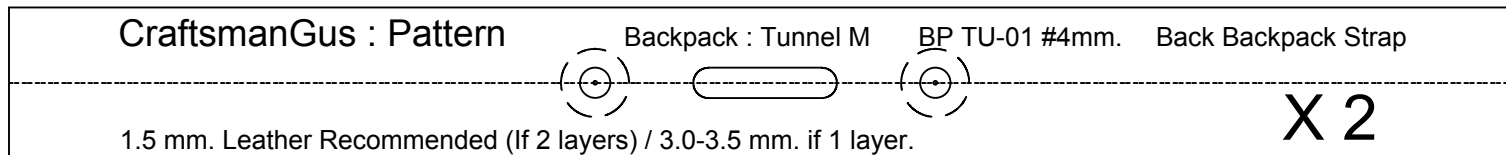
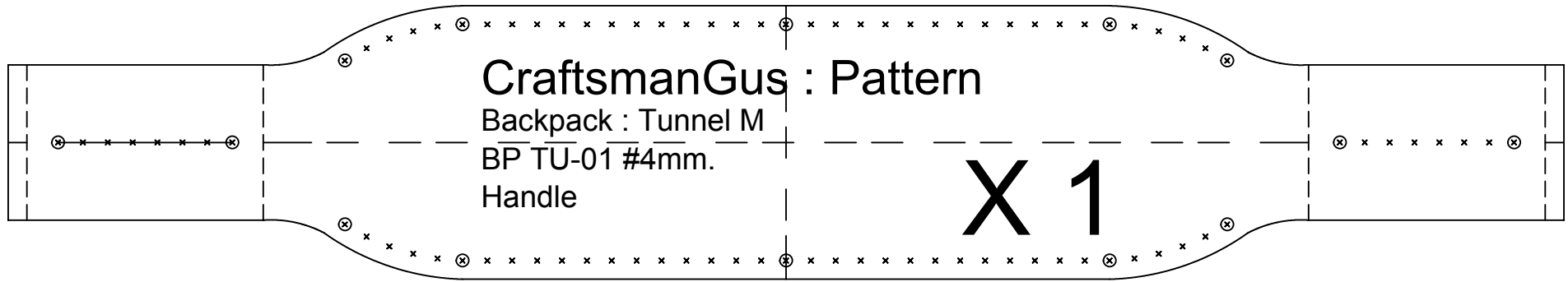

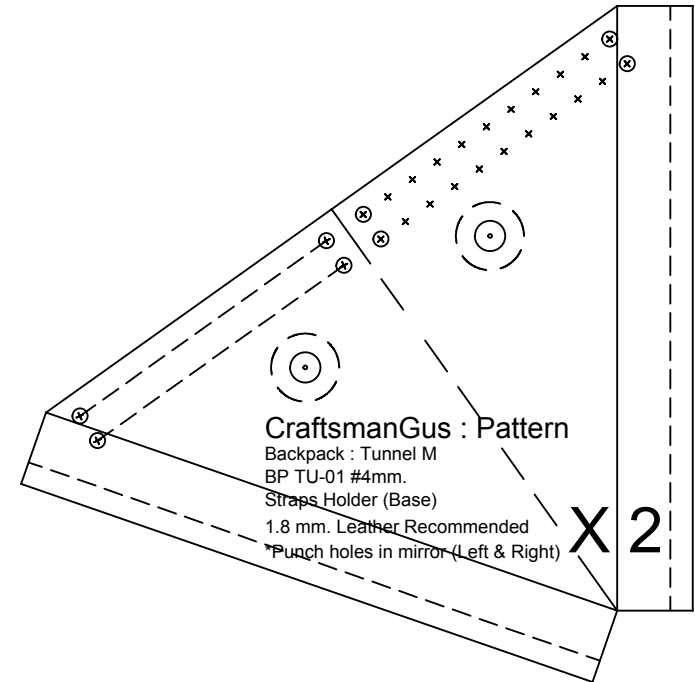
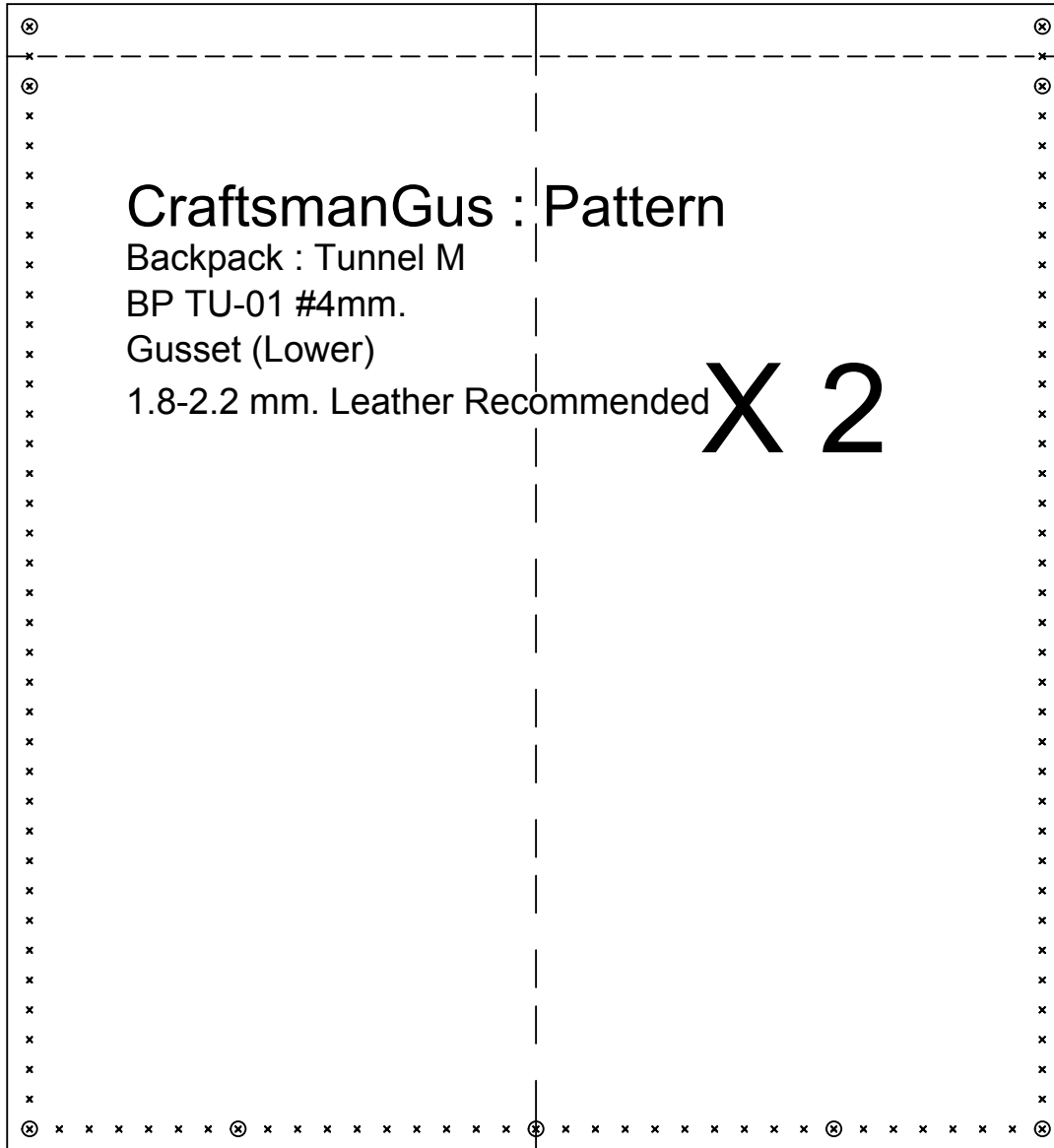

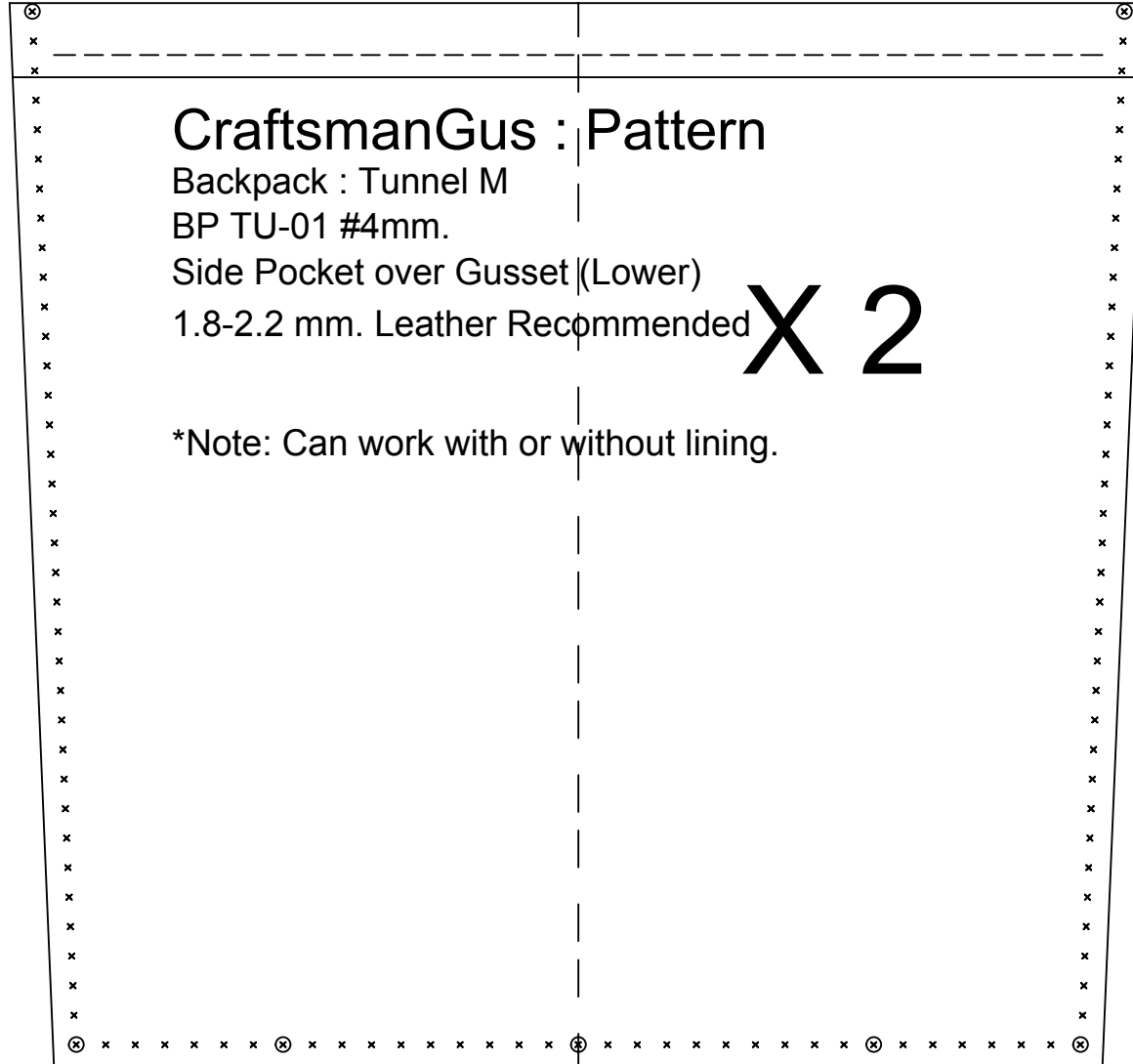

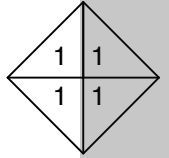

# CraftsmanGus : Pattern

Backpack : Tunnel M

BP TU-01 #4mm.

Main Body

# X 1

TILE TO PAGE 5

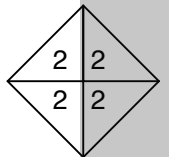
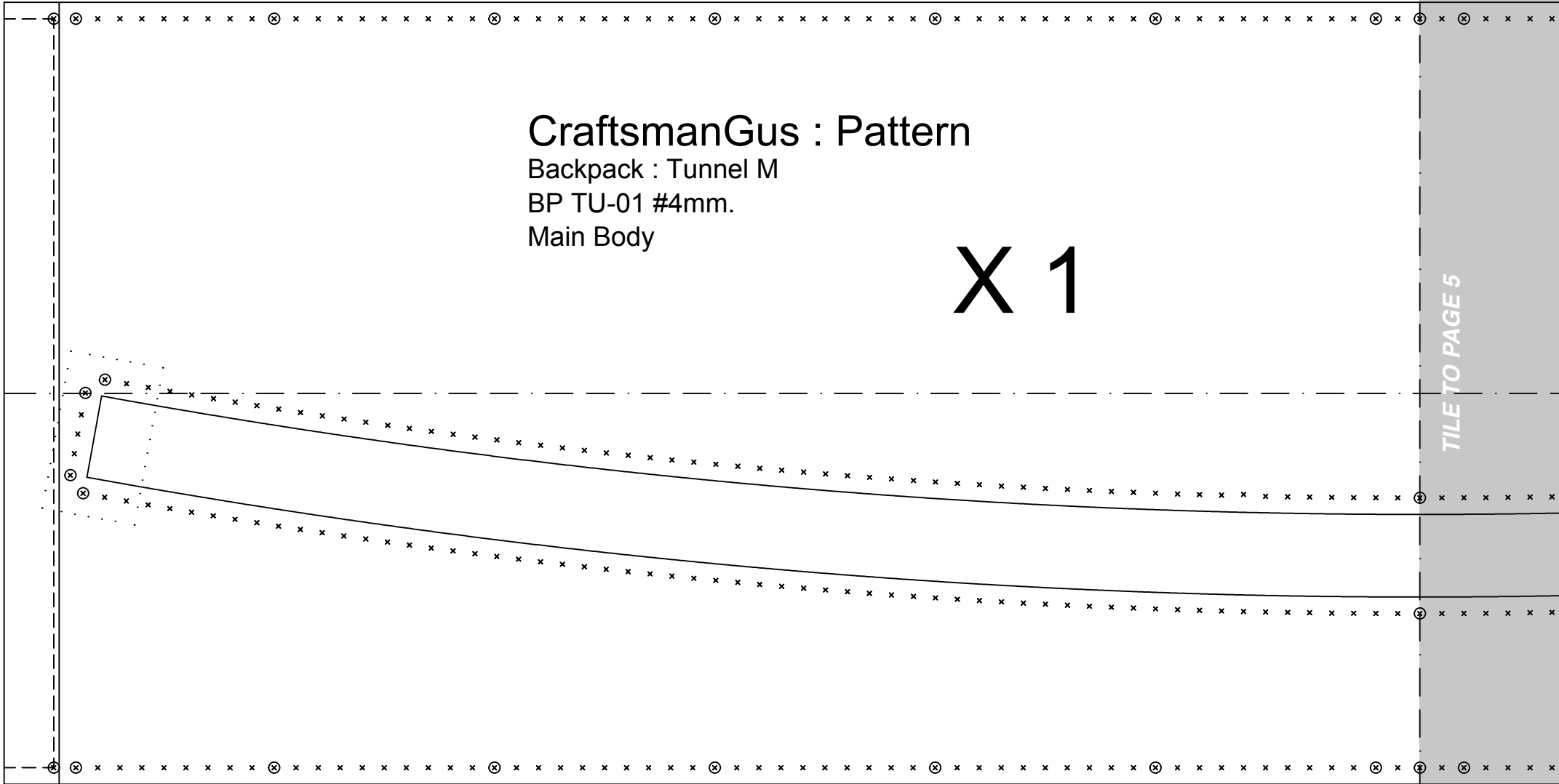

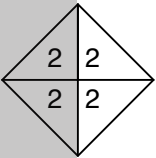
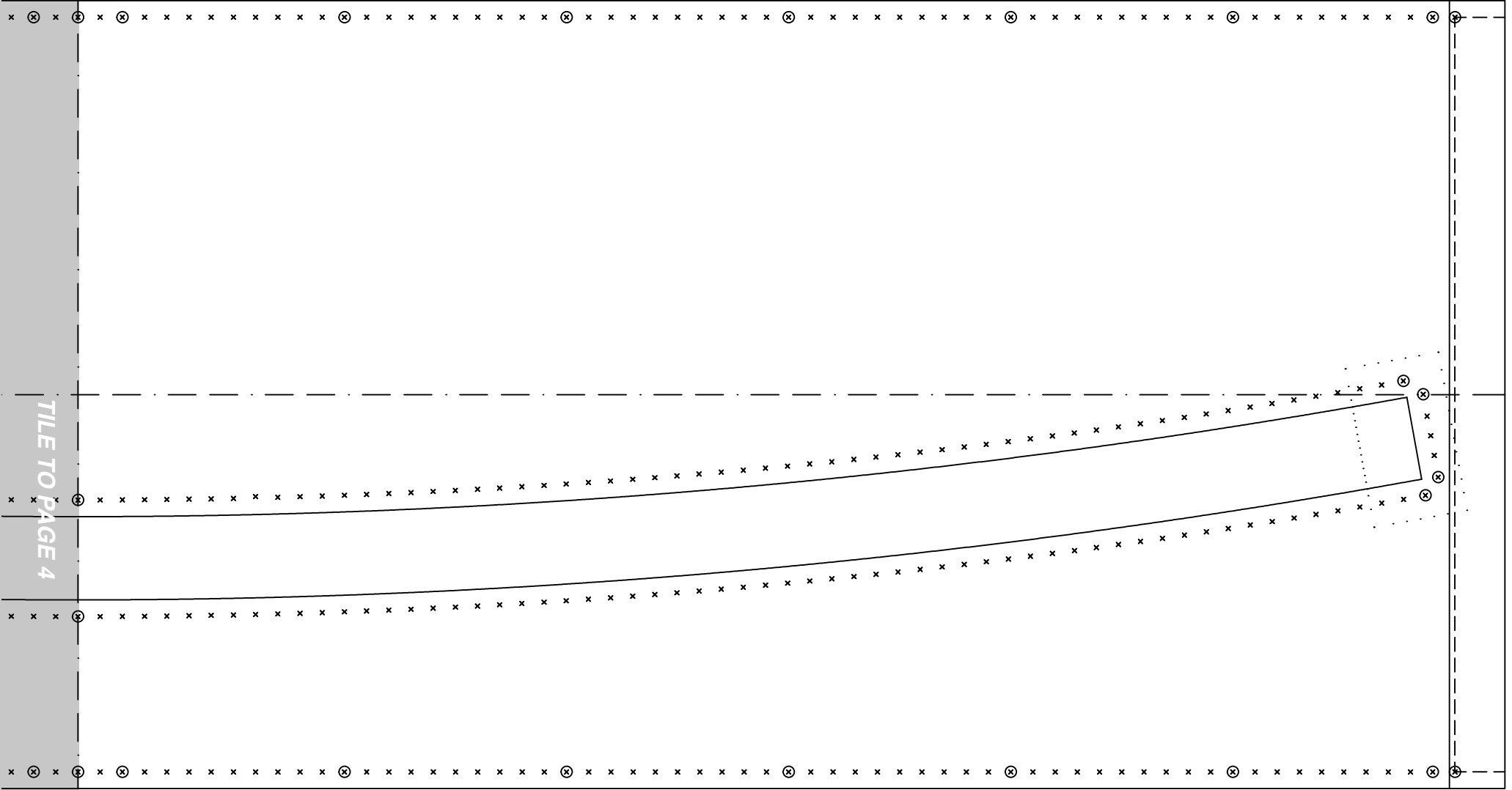
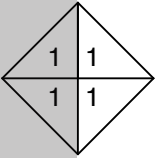

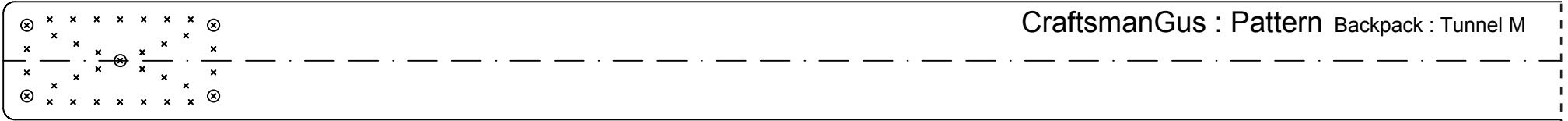

BP TU-01 #4mm. Back Backpack Strap (Right) 2.2 mm. Leather Recommended (If 2 layers) / 3.0-3.5 mm. if 1 layer.

X 2

Distance varies as per person

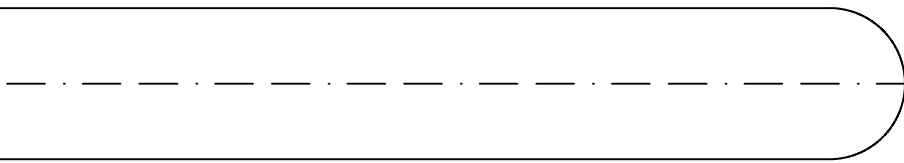

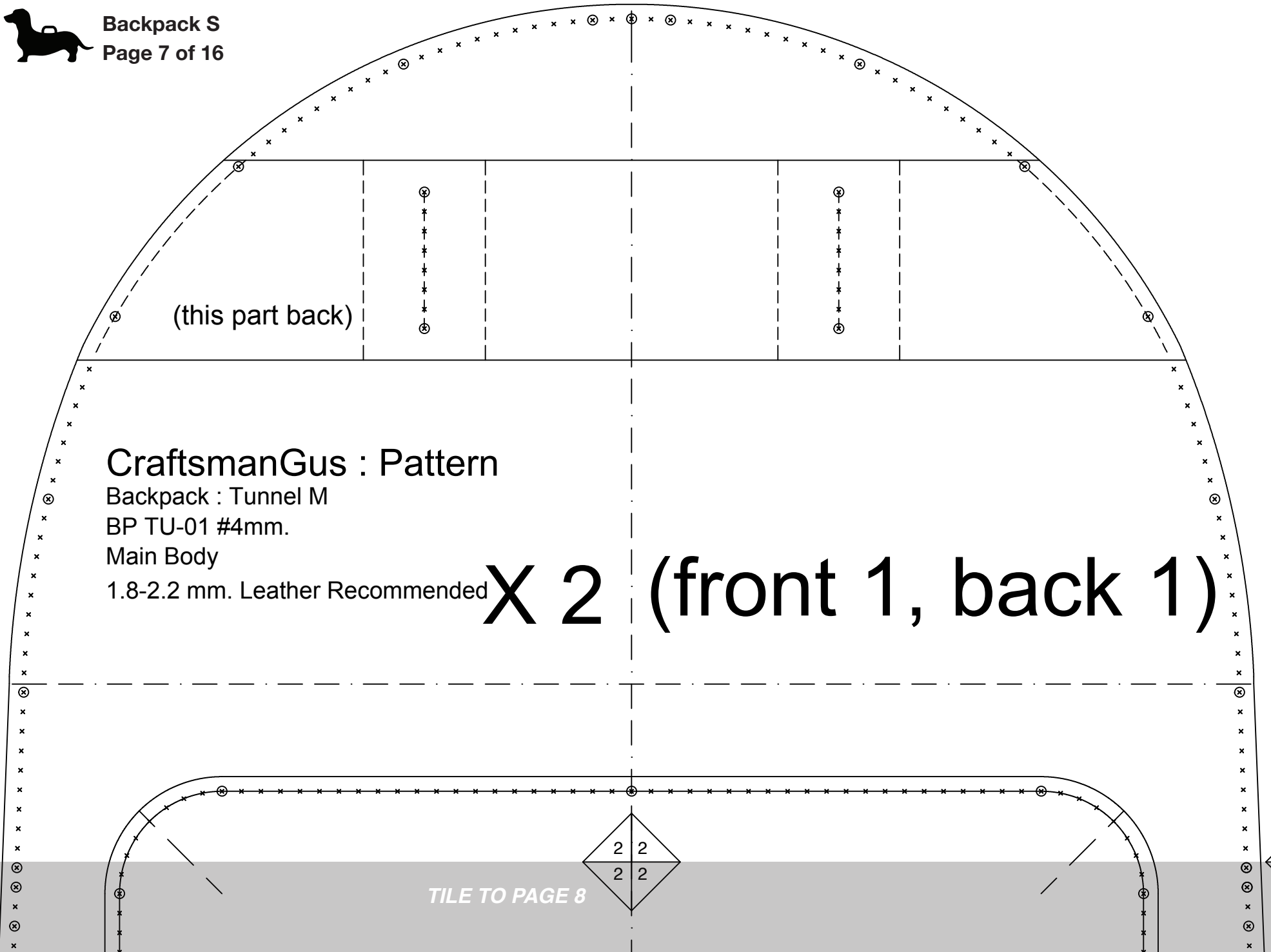

(this part back)

### CraftsmanGus : Pattern

Backpack : Tunnel M

BP TU-01 #4mm.

Main Body

1.8-2.2 mm. Leather Recommended

# X 2 (front 1, back 1)

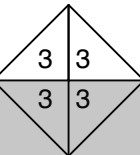
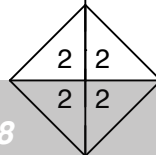
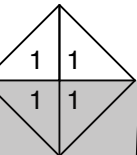

TILE TO PAGE 8





Backpack S  
Page 8 of 16

TILE TO PAGE 7

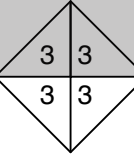
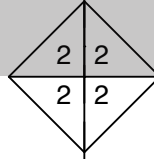
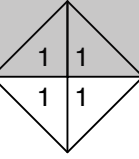

(this part front)

(this part back)

(this part back)

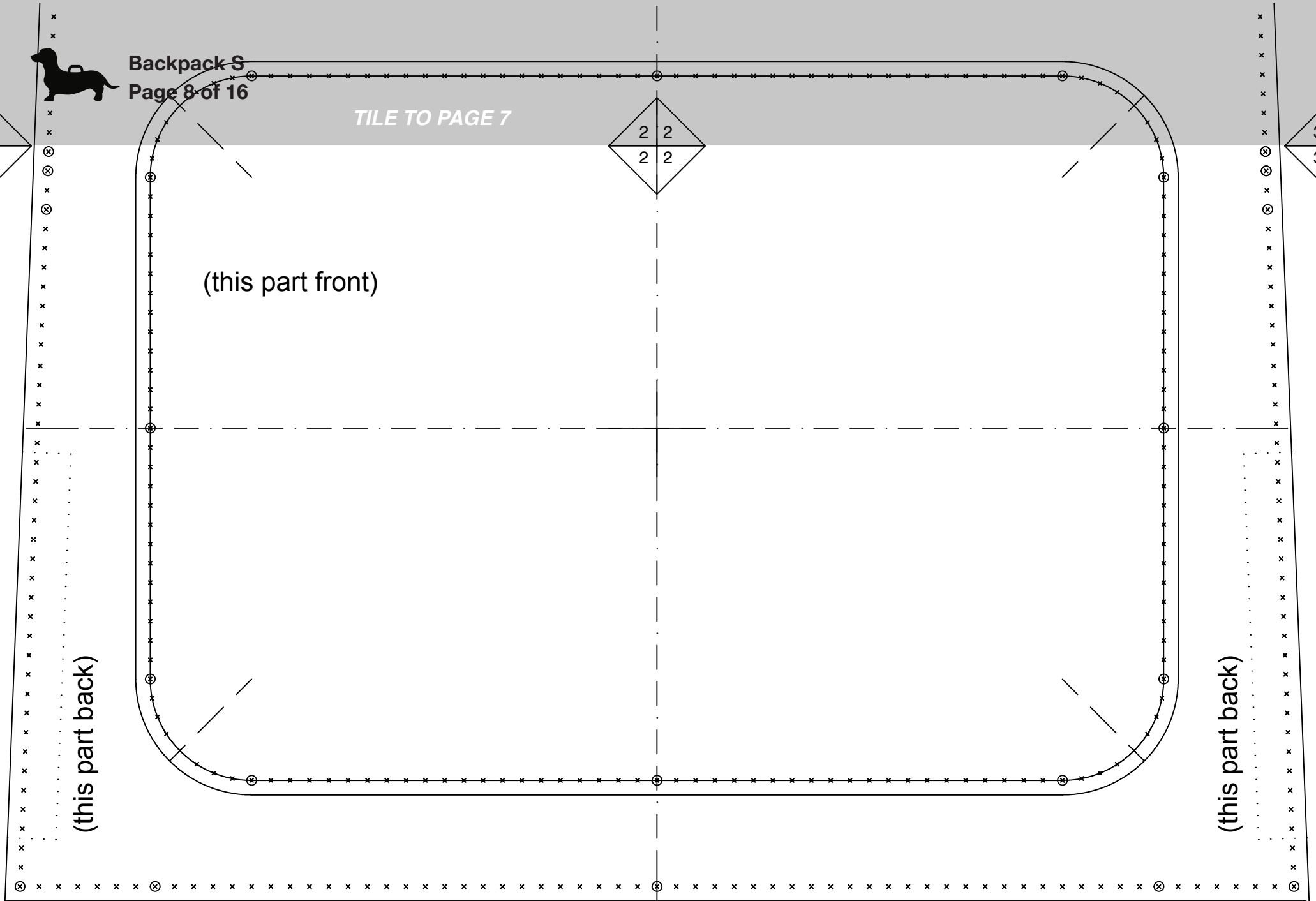



TILE TO PAGE 10

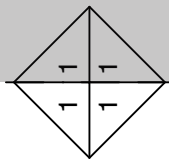

# CraftsmanGus : Pattern

Backpack : Tunnel M  
BP TU-01 #4mm.

Bottom

1.8-2.2 mm. Leather Recommended **X 1**

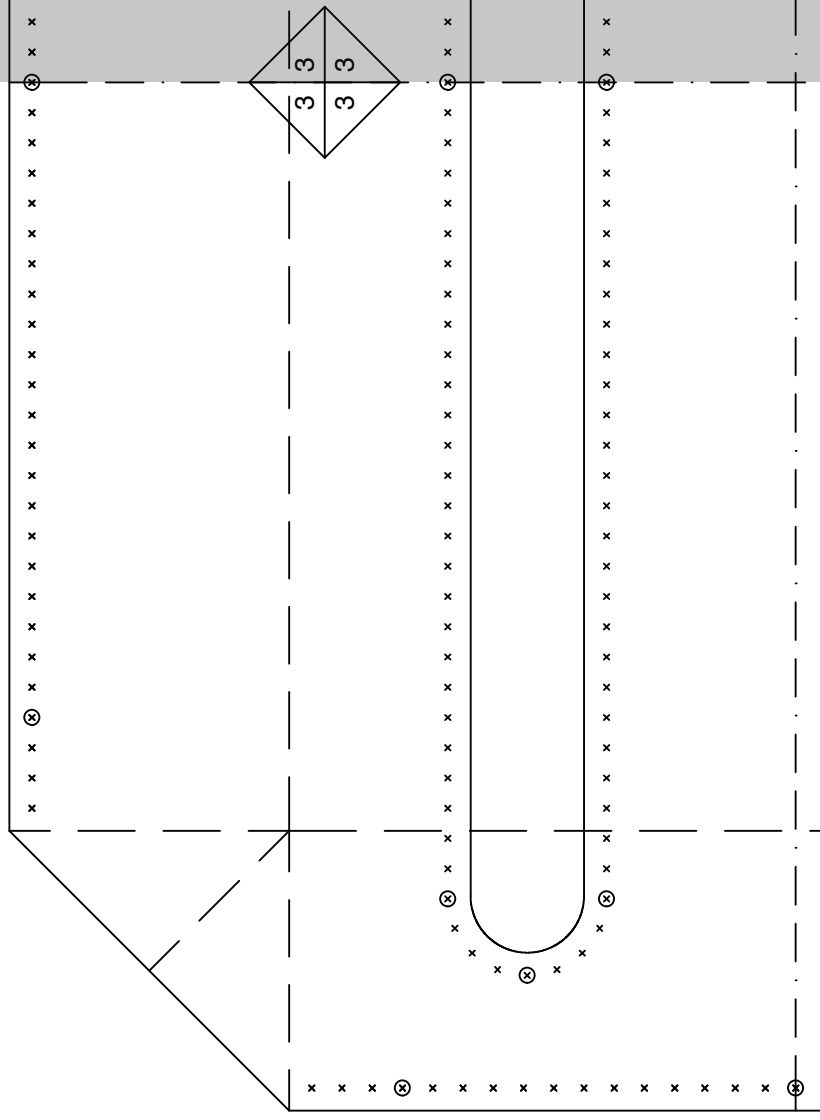
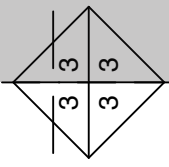
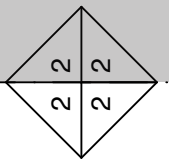

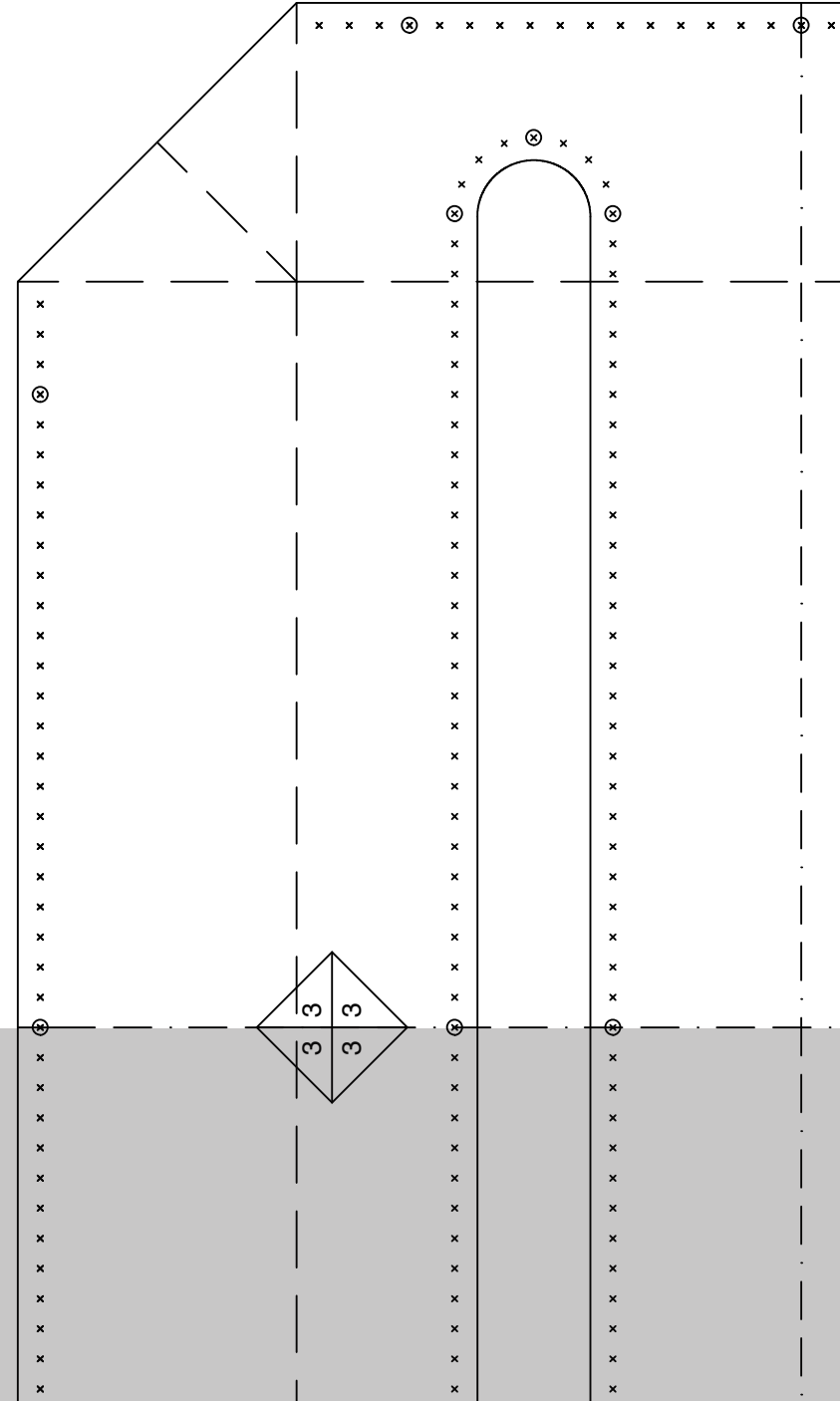
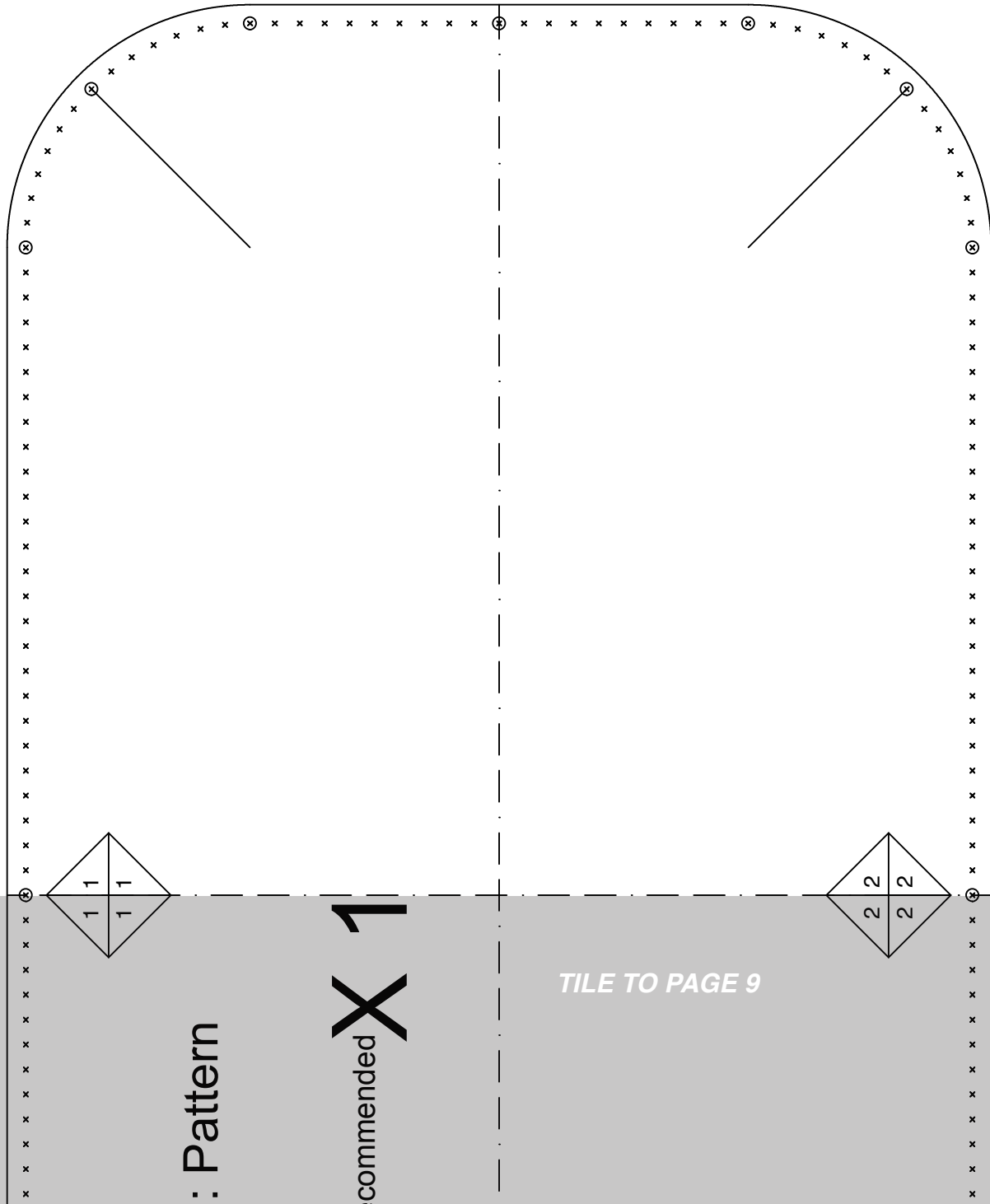

: Pattern

commended **X 1**

TILE TO PAGE 9

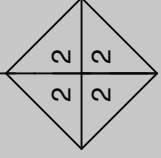

TILE TO PAGE 9

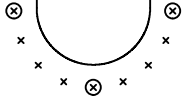
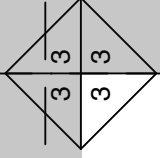

# CraftsmanGus : Pattern

Backpack : Tunnel M

BP TU-01 #4mm.

Front Pocket

1.8-2.2 mm. Leather Recommended **X 1**

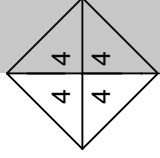

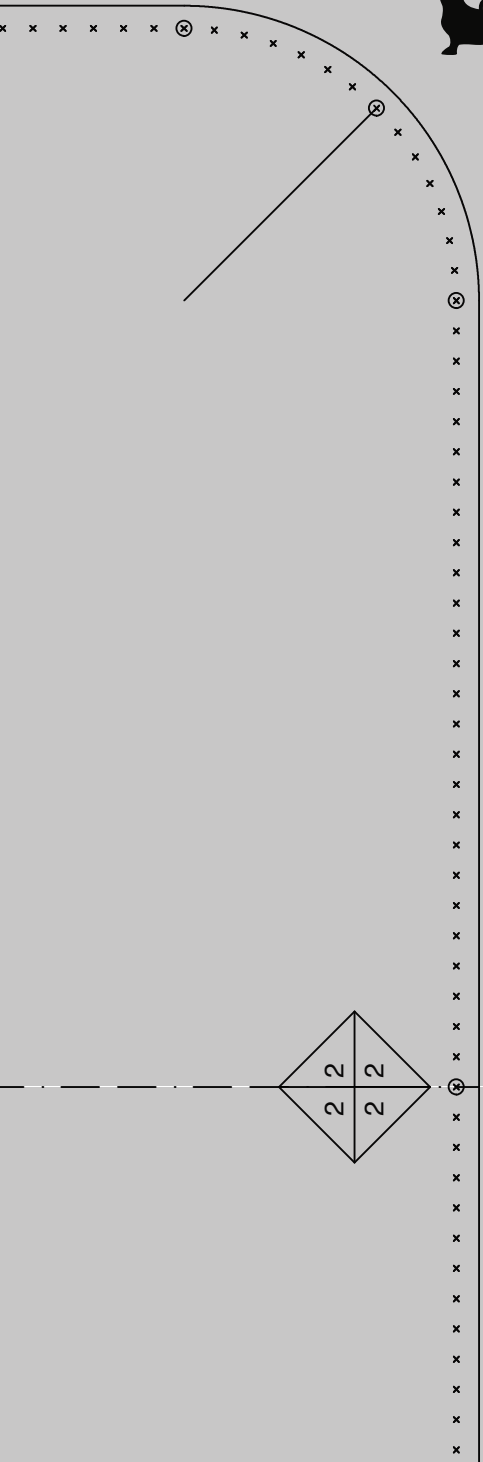

TILE TO PAGE 10

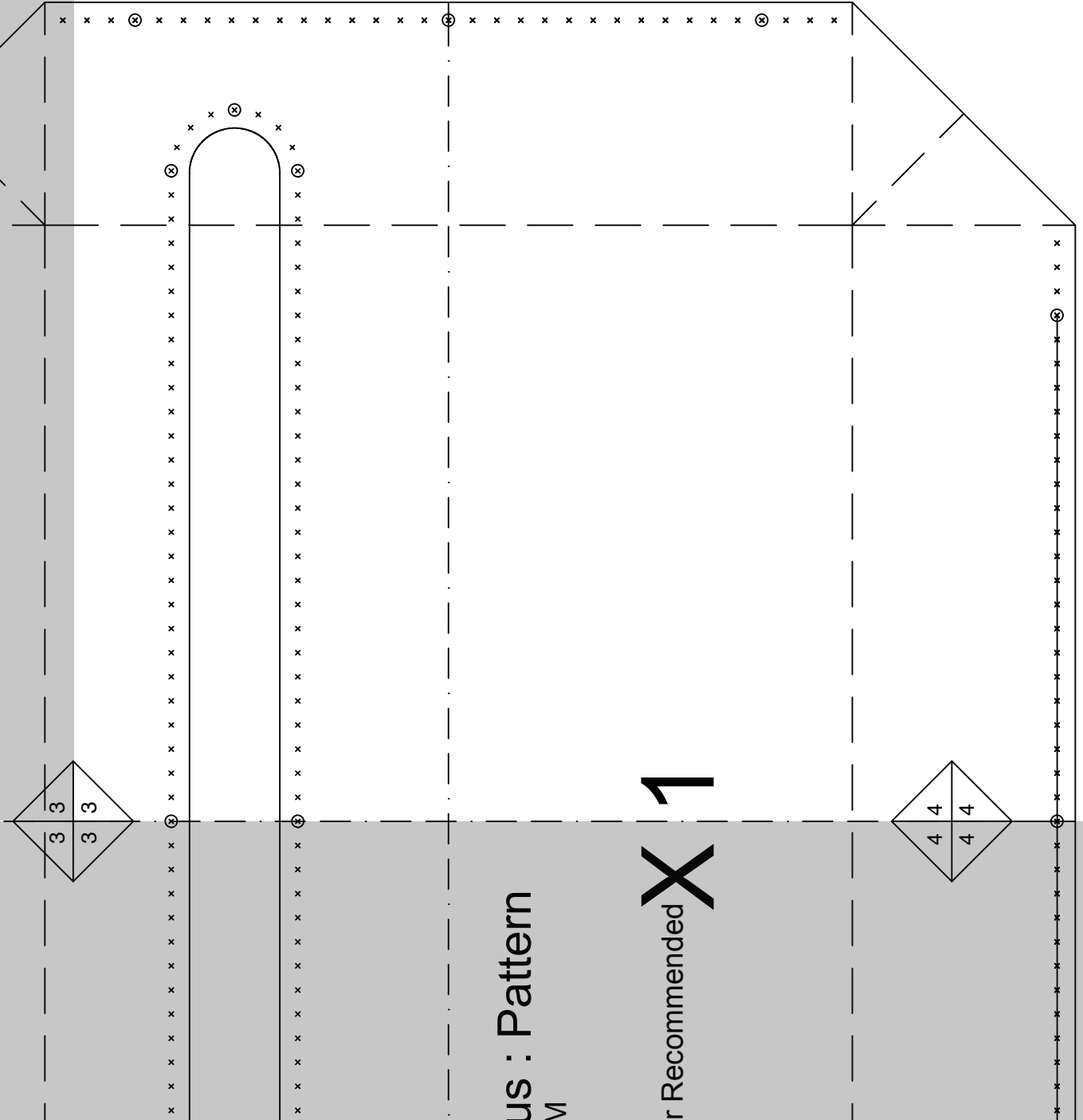

us : Pattern  
M

r Recommended **X 1**

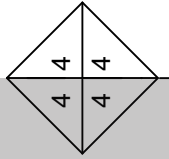

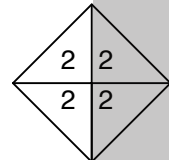
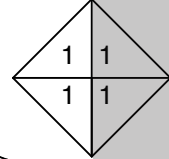
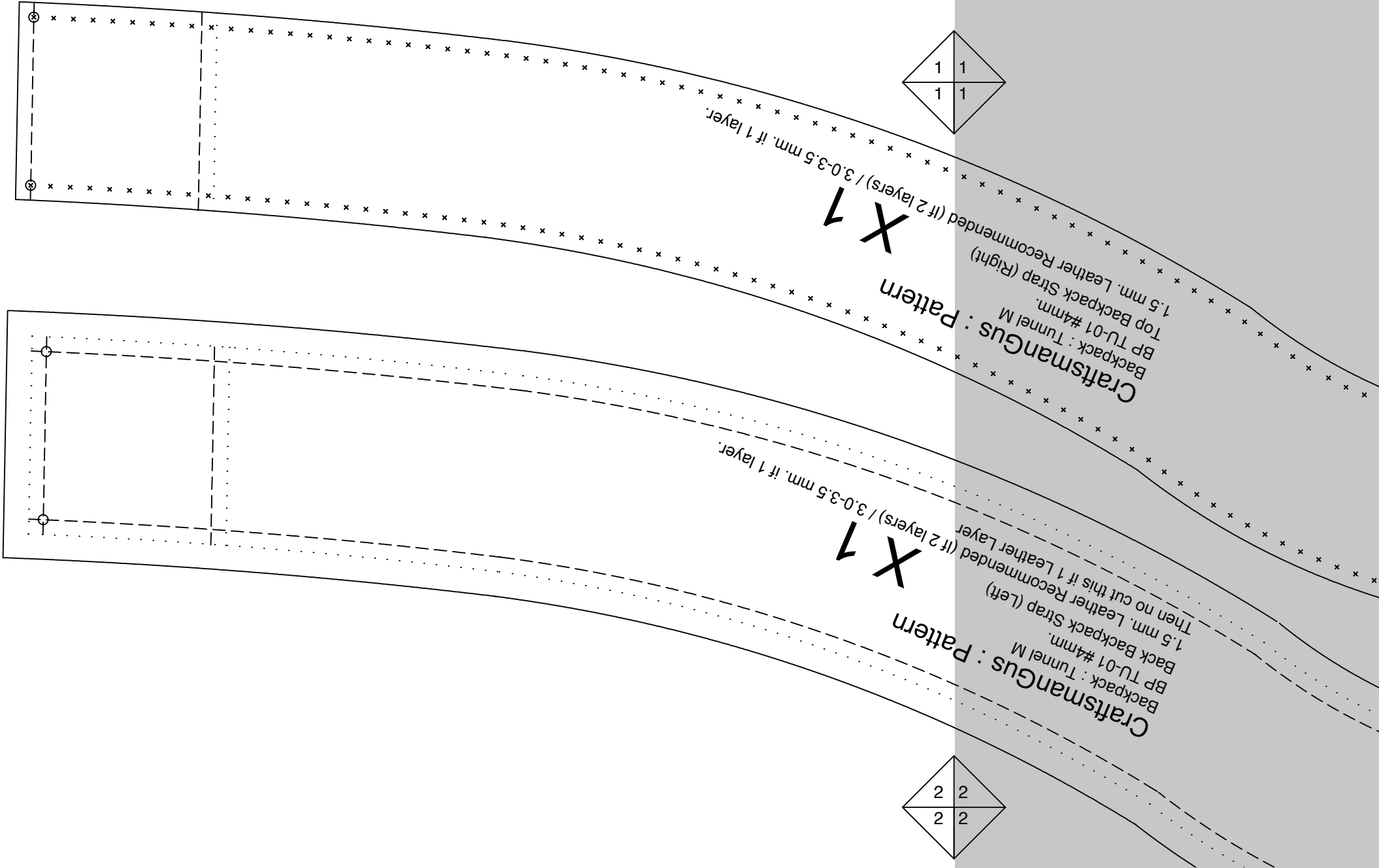

Craftsmangus : Pattern  
Backpack : Tunnel M  
BP TU-01 #4mm.  
1.5 mm. Leather Recommended (if 2 layers) / 3.0-3.5 mm. if 1 layer.

Craftsmangus : Pattern  
Backpack : Tunnel M  
BP TU-01 #4mm.  
1.5 mm. Leather Recommended (if 2 layers) / 3.0-3.5 mm. if 1 layer.  
Then no cut this if 1 Leather Layer.

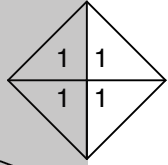

**Craftsmangus : Pattern**  
 Backpack : Tunnel M  
 BP TU-01 #4mm.  
 Top Backpack Strap (Right)  
 1.5 mm. Leather Recommended (if 2 layers) / 3.0-3.5 mm. if 1 layer.

X 1

**Craftsmangus : Pattern**  
 Backpack : Tunnel M  
 BP TU-01 #4mm.  
 Back Backpack Strap (Left)  
 1.5 mm. Leather Recommended (if 2 layers) / 3.0-3.5 mm. if 1 layer.  
 Then no cut this if 1 Leather Layer

X 1

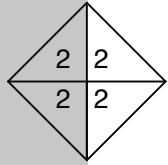

TILE TO PAGE 13



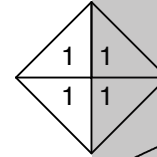

Then no cut this if 1 Leather Layer  
1.5 mm. Leather Recommended  
Back Backpack Strap (Right)  
BP TU-01 #4mm.  
Backpack : Tunnel M  
Craftsmangus : Pattern X 1  
(if 2 layers) / 3.0-3.5 mm. if 1 layer.

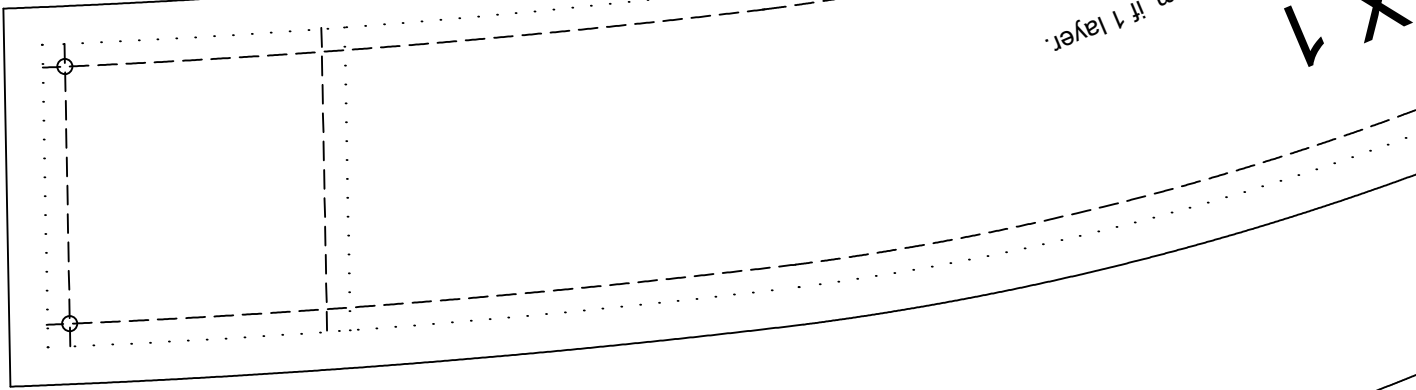

X 1

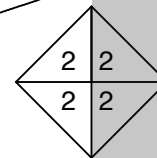

1.5 mm. Leather Recommended (if 2 layers) / 3.0-3.5 mm. if 1 layer.  
Top Backpack Strap (Left)  
BP TU-01 #4mm.  
Backpack : Tunnel M  
Craftsmangus : Pattern X 1

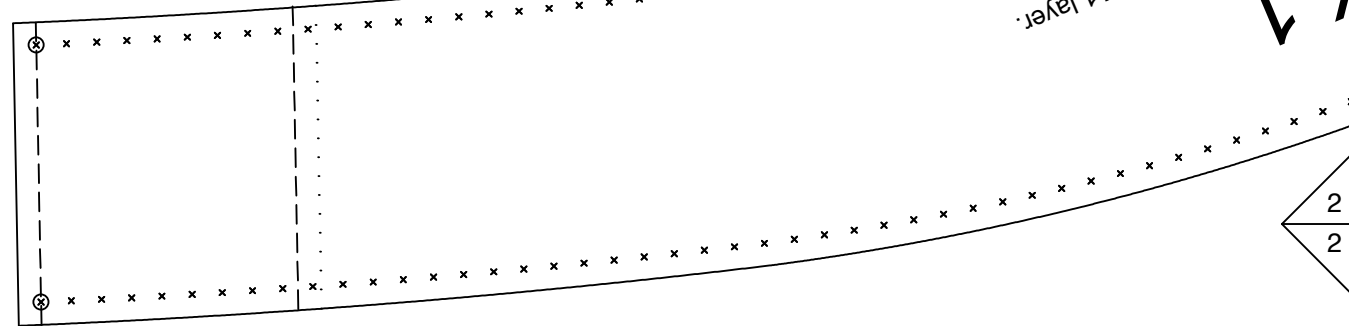

X 1

TILE TO PAGE 16





TILE TO PAGE 15

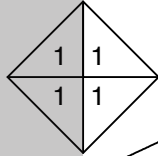

Then no cut this if 1 Leather Layer  
1.5 mm. Leather Recommended (if 2 layers) / 3.0-3.5 mm. if 1 layer.  
Back Backpack Strap (Right)  
BP TU-01 #4mm.  
Backpack : Tunnel M  
**Craftsmangus : Pattern X 1**

X 1

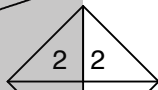

1.5 mm. Leather Recommended (if 2 layers) / 3.0-3.5 mm. if 1 layer.  
Top Backpack Strap (Left)  
BP TU-01 #4mm.  
Backpack : Tunnel M  
**Craftsmangus : Pattern X 1**

X 1

