

80. Making backpack / 백팩 만들기

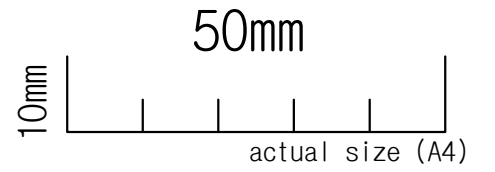

A

1 / 30

Backpack
Leather 2.0t X1

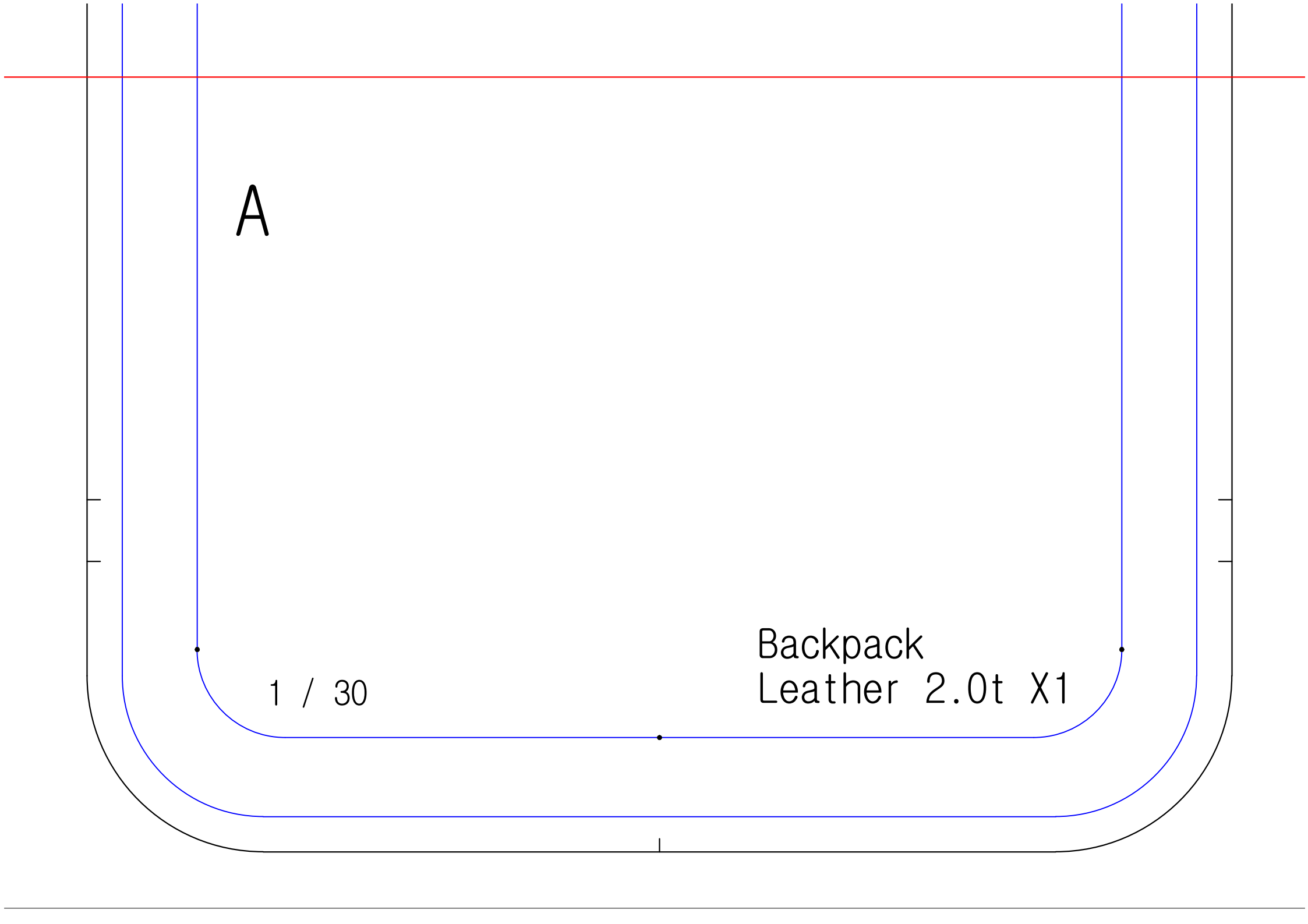

80. Making backpack / 백팩 만들기

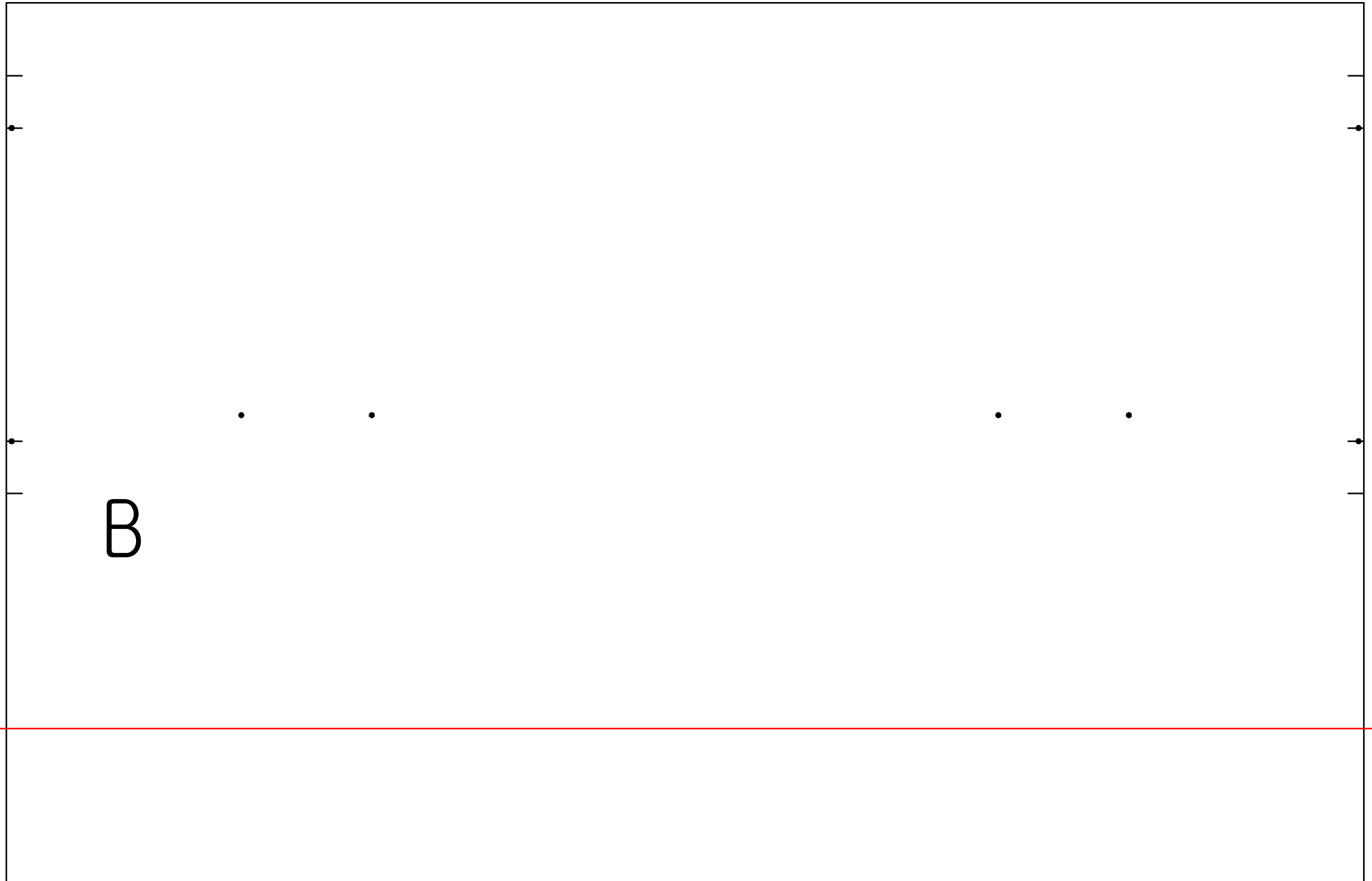
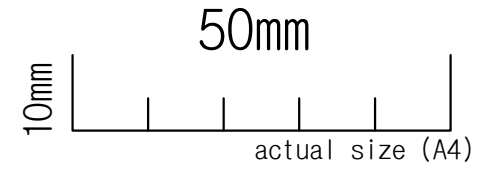

B

B

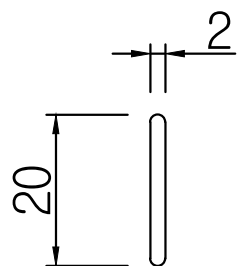

2 / 30

Backpack
Leather 2.0t X1

80. Making backpack / 백팩 만들기

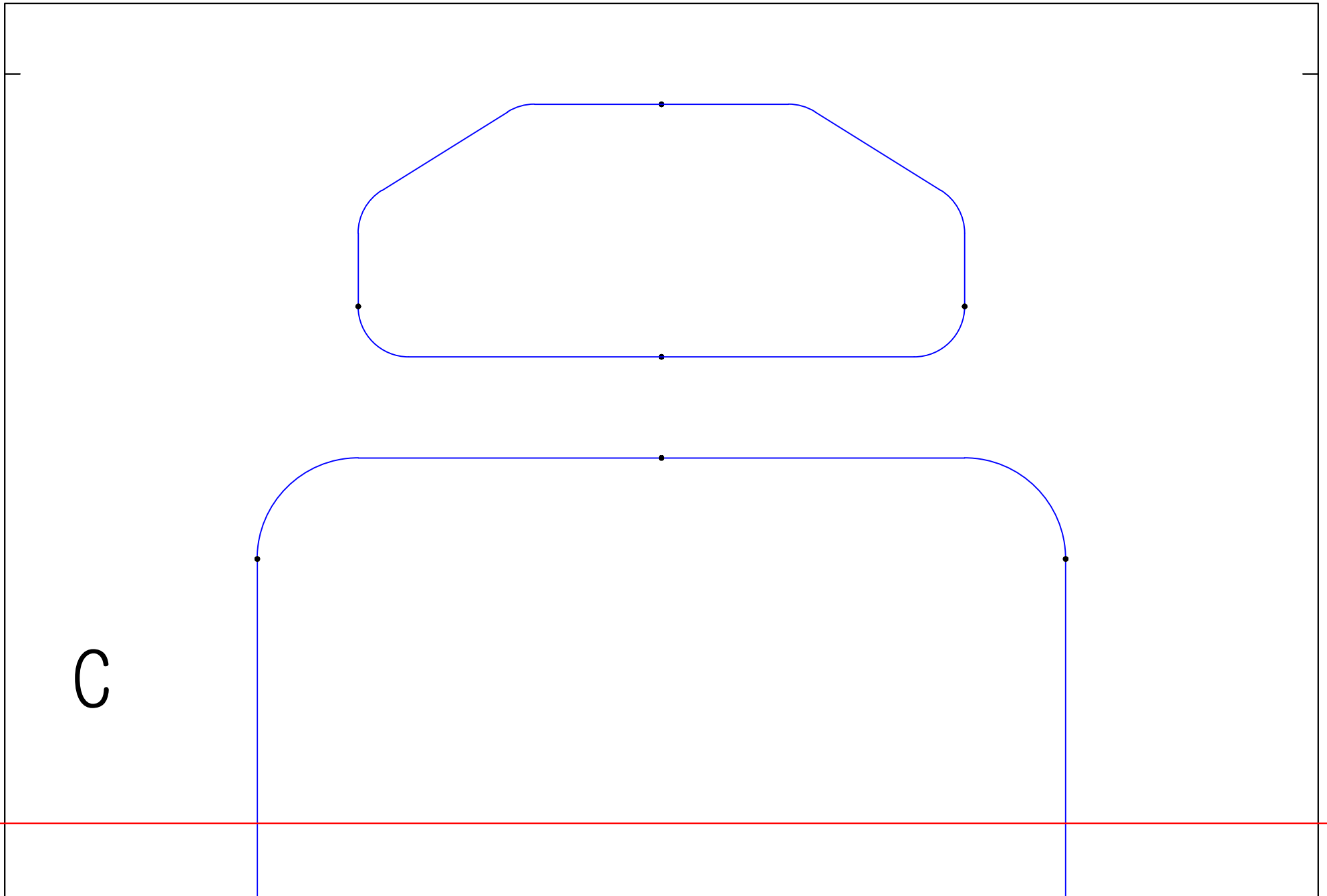
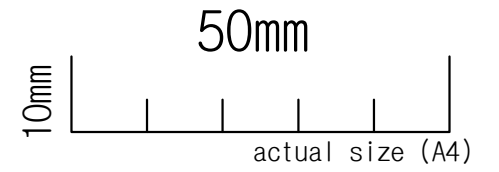

C

3 / 30

Backpack
Leather 2.0t X1

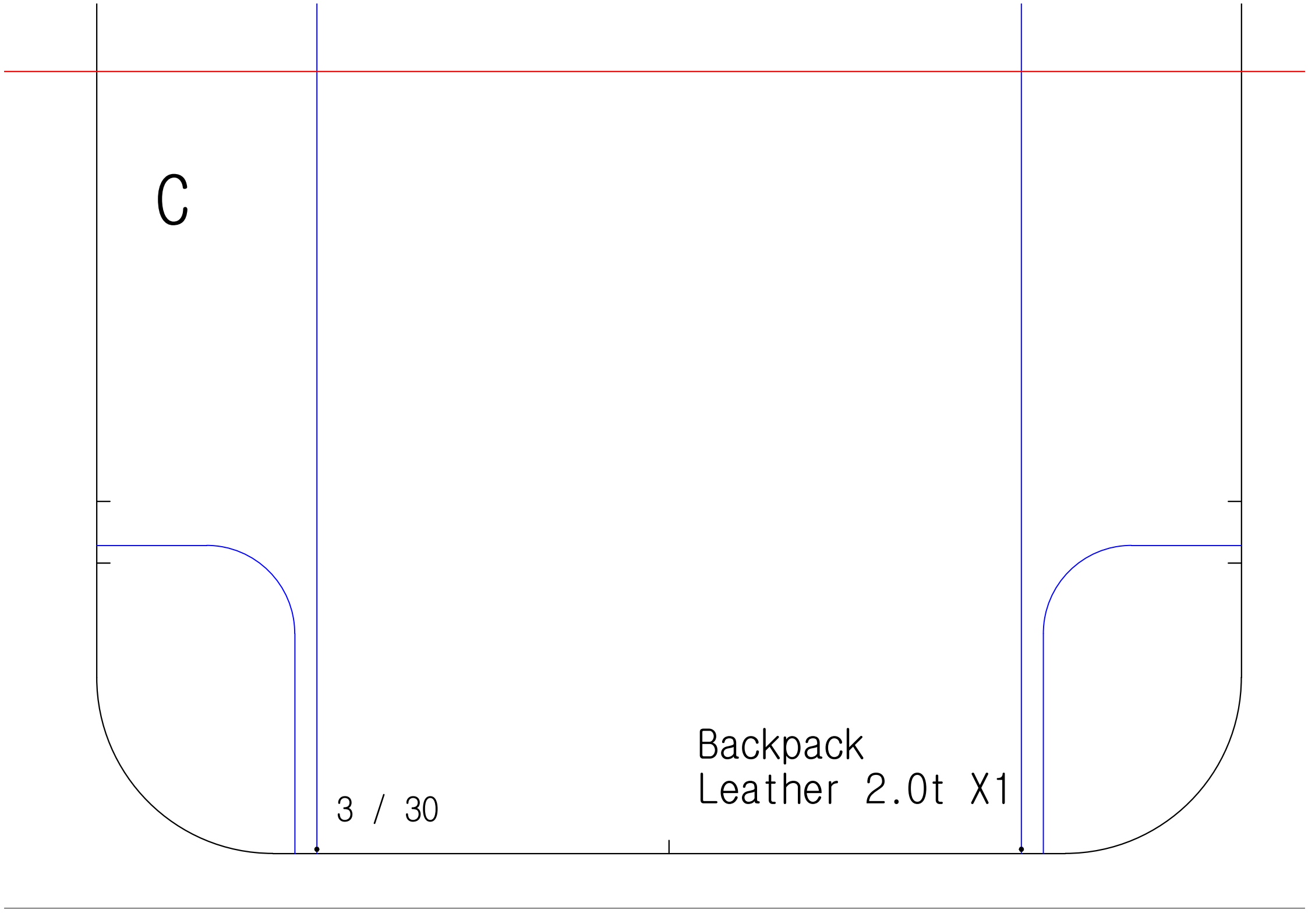

80. Making backpack / 백팩 만들기

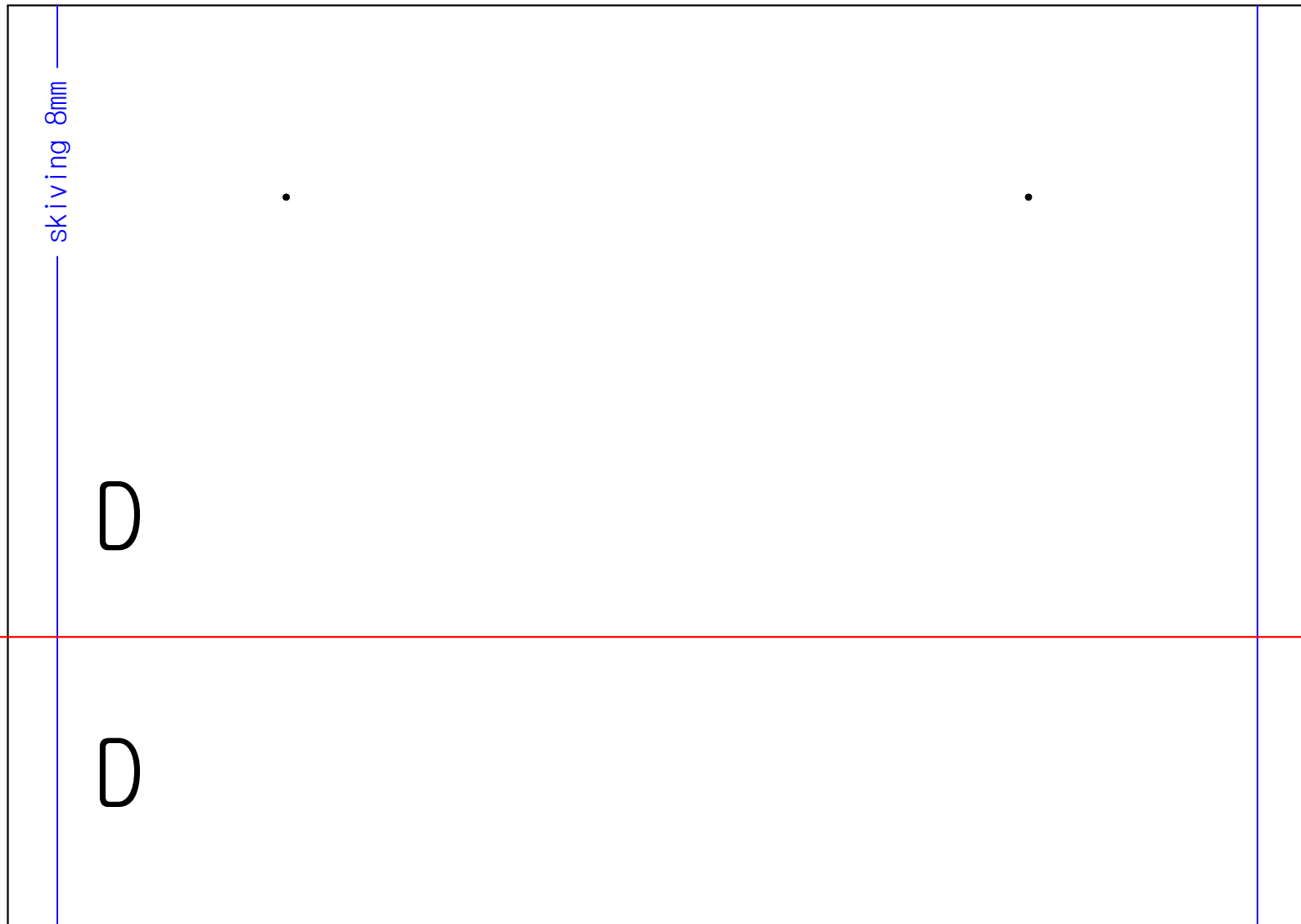
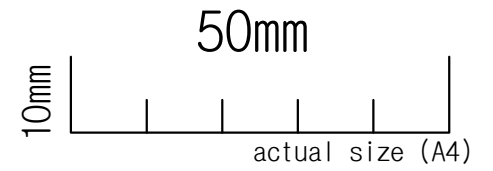

D

D

| |
| |

| |
| |

4 / 30

Backpack
Leather 2.0t X1

80. Making backpack / 백팩 만들기

skiving 8mm

8 / 30

F

21 / 30

E

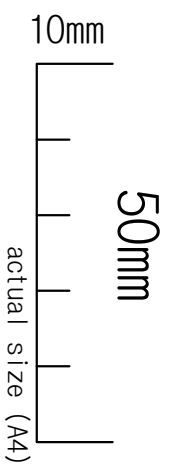

F

Backpack
Leather 2.0t X 1

E

Backpack
Leather 1.0t X 2

80. Making backpack / 백팩 만들기

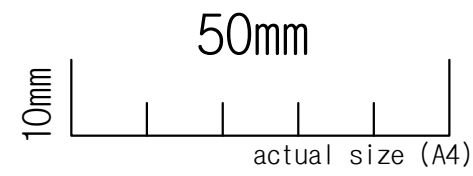

5 / 30

Backpack
Leather 1.0t X1

80. Making backpack / 백팩 만들기

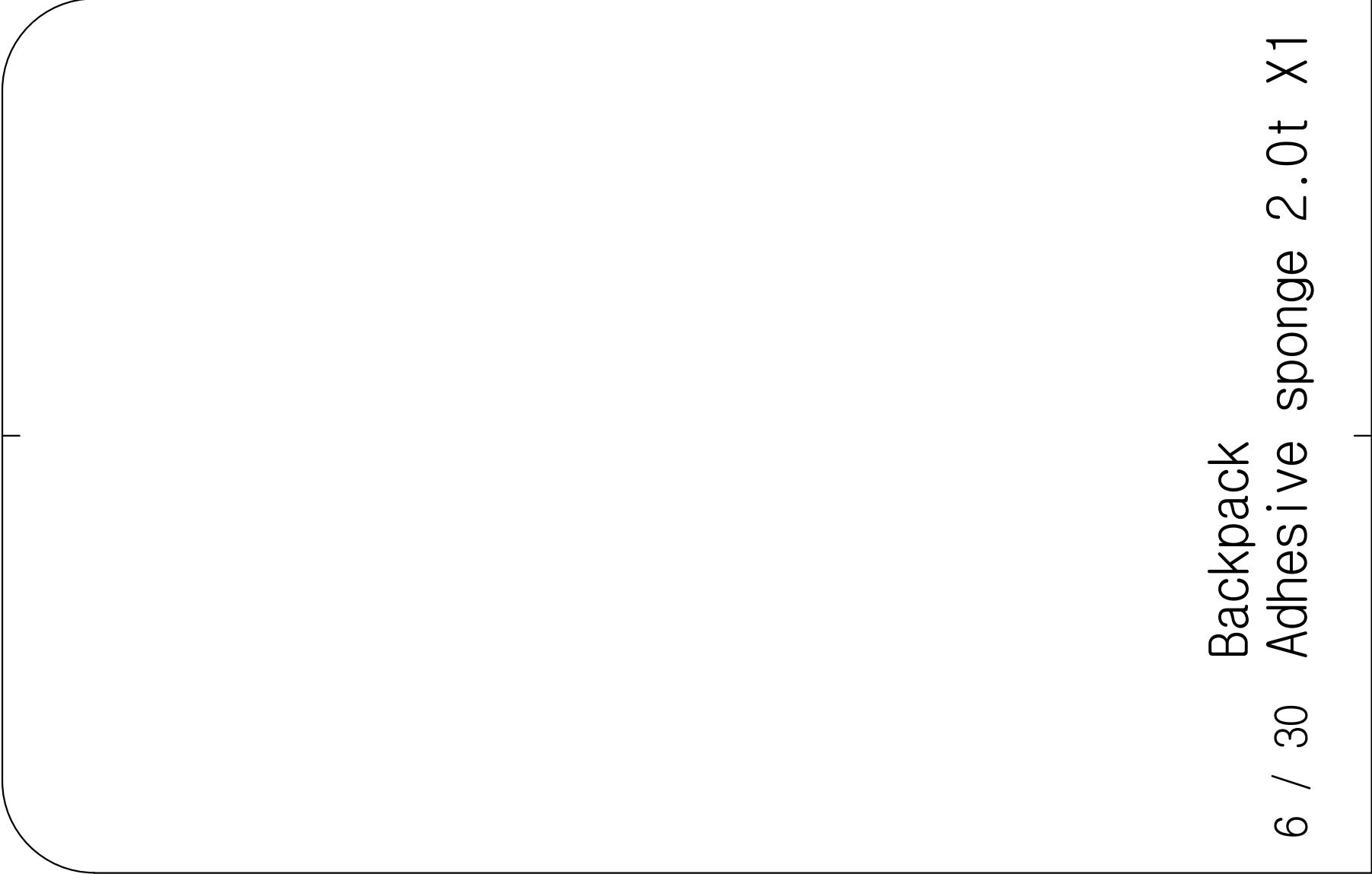
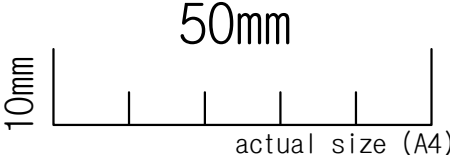

6 / 30 Backpack
Adhesive sponge 2.0t X1

80. Making backpack / 백팩 만들기

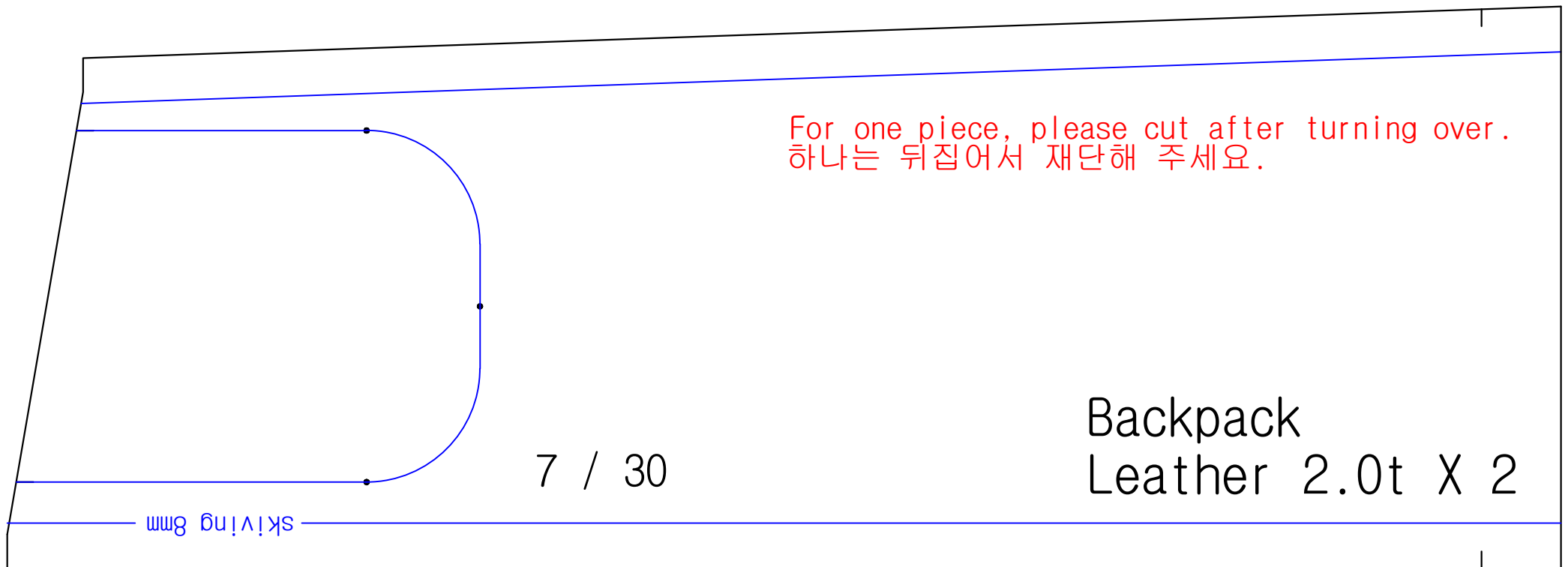
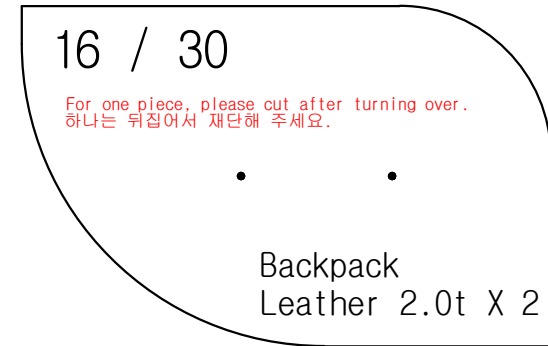
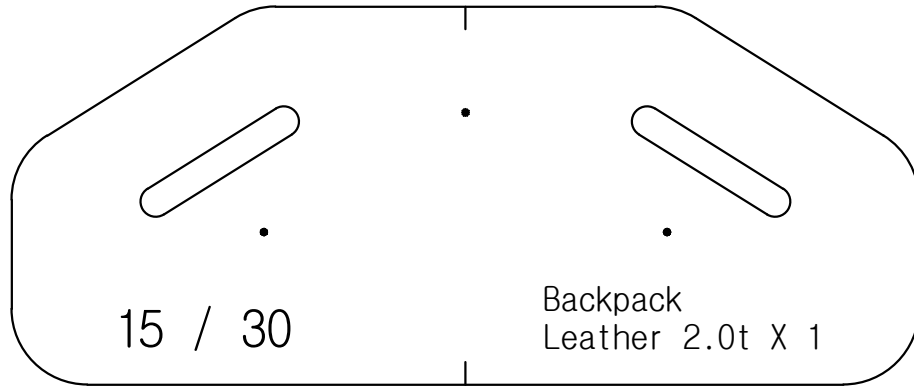
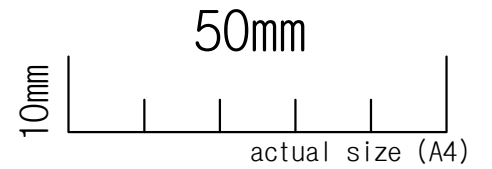

80. Making backpack / 백팩 만들기

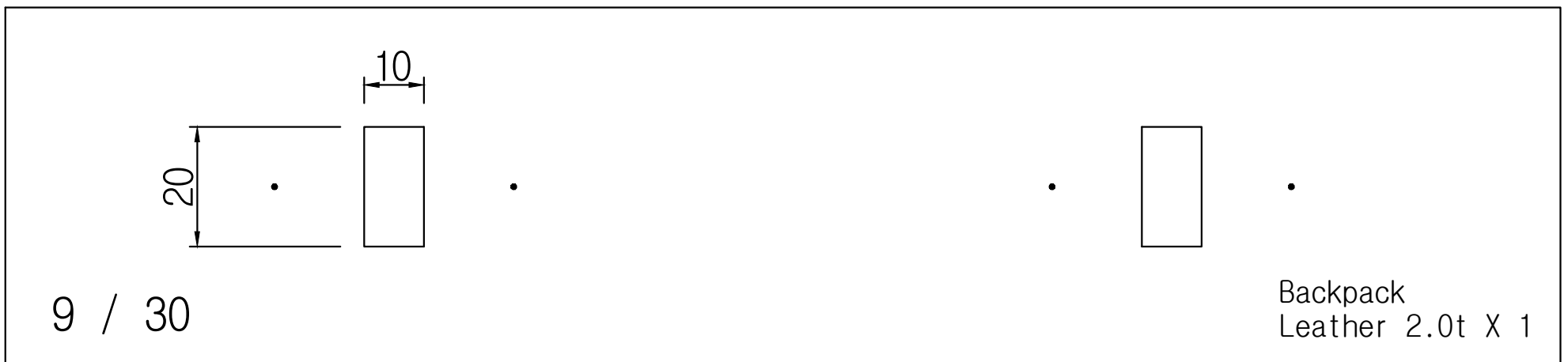
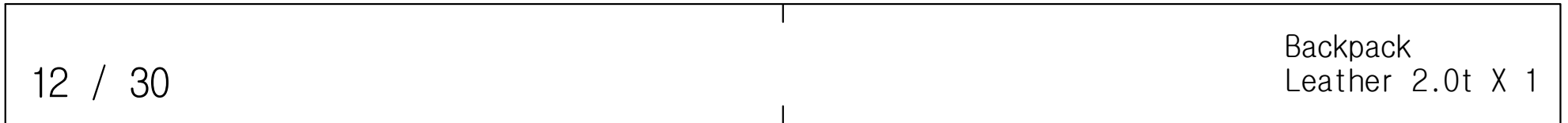
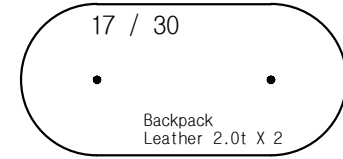
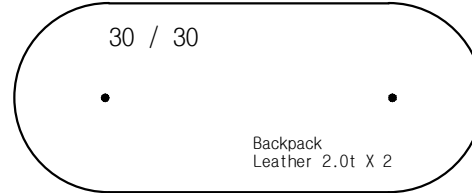
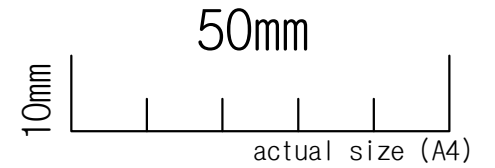

80. Making backpack / 백팩 만들기

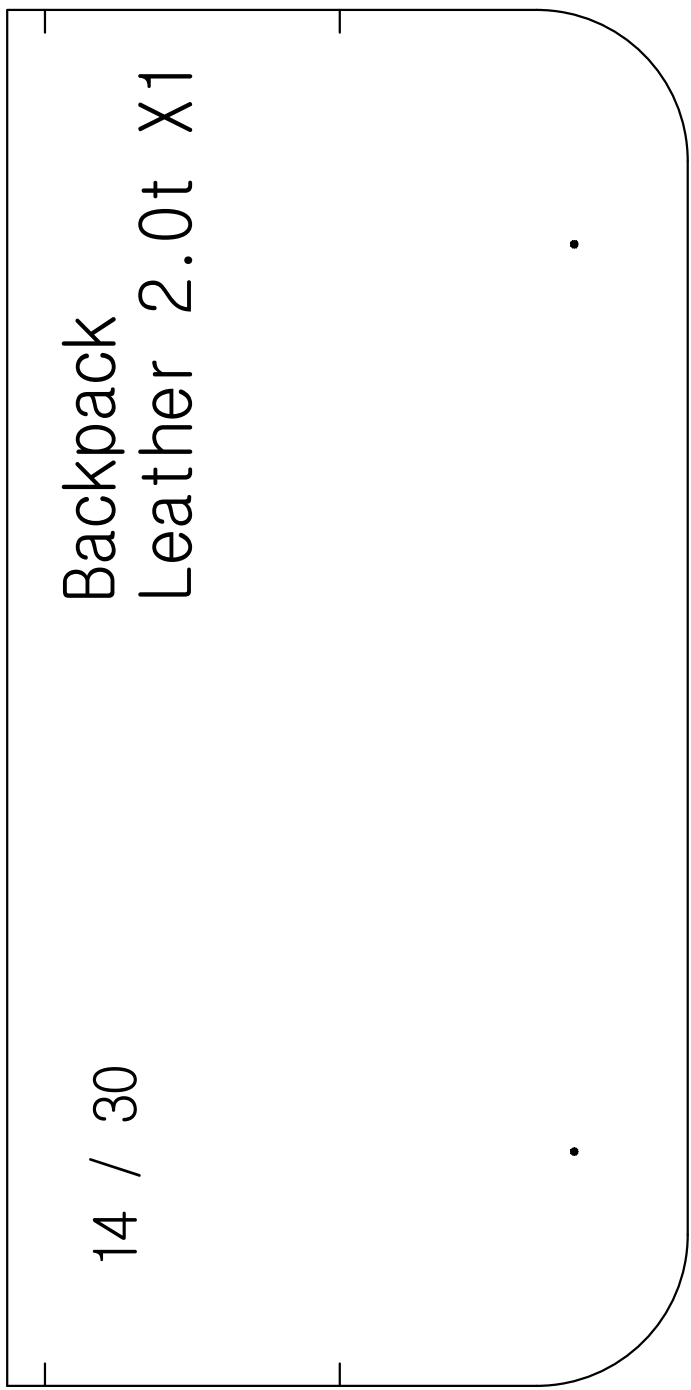
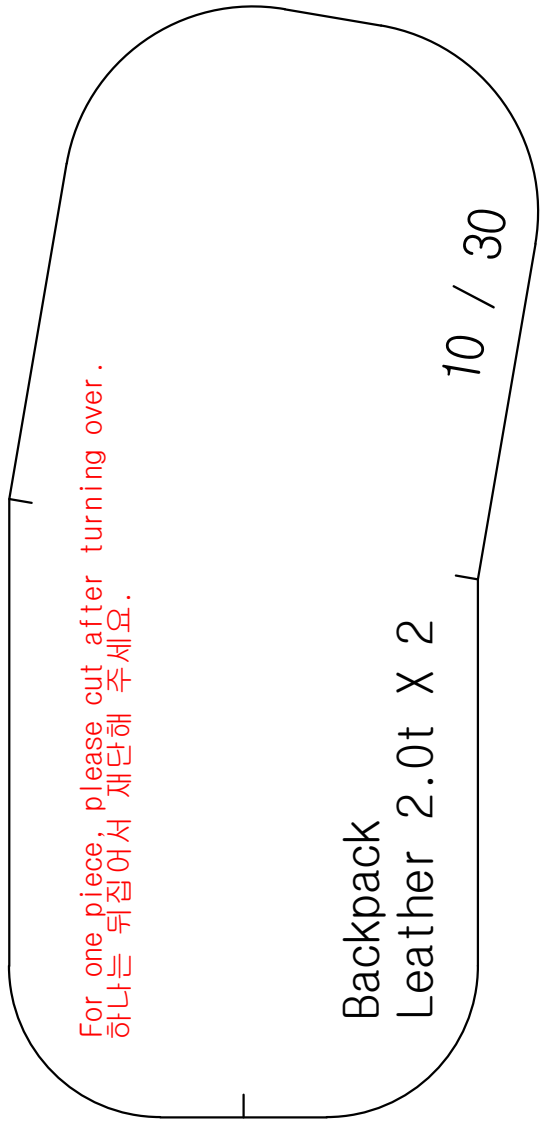
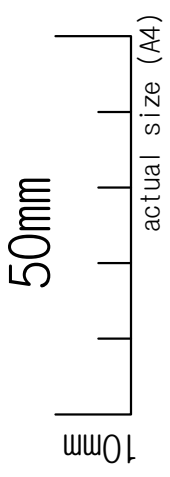

80. Making backpack / 백팩 만들기

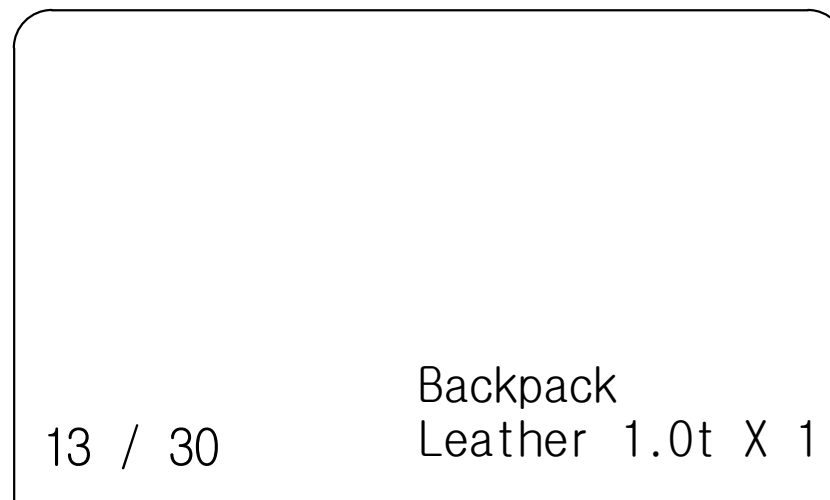
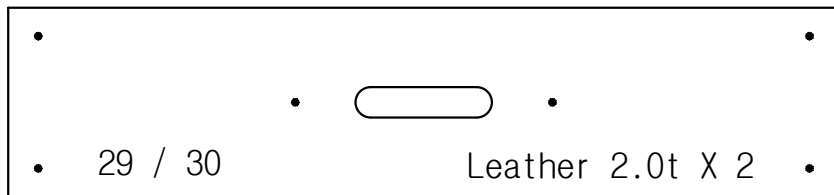
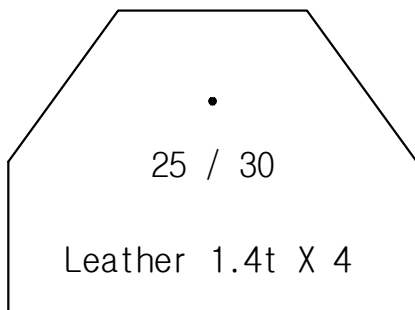
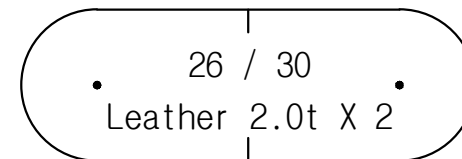
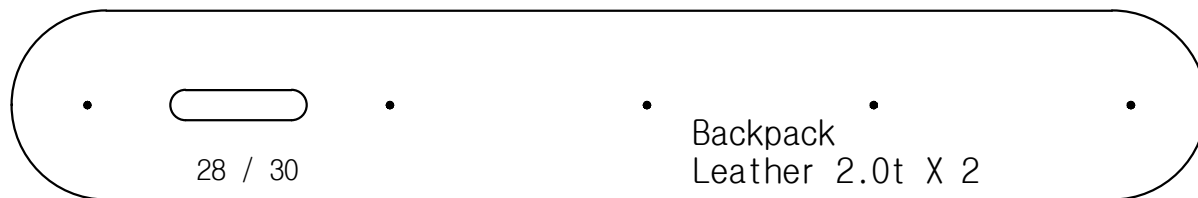
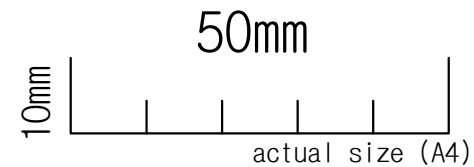

80. Making backpack / 백팩 만들기

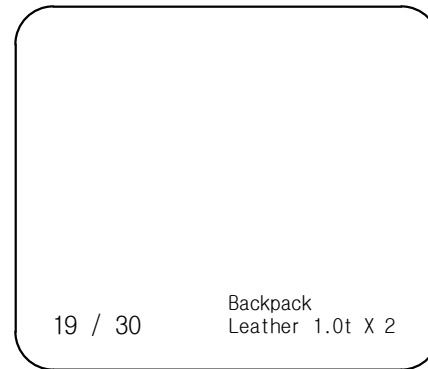
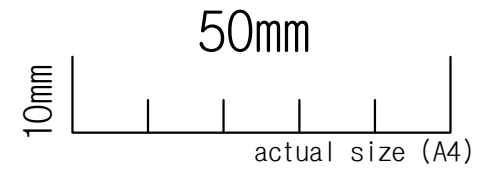

23 / 30

Backpack
Adhesive sponge 2.0t X 4

80. Making backpack / 백팩 만들기

non scale

