

CREATIVE AWL

leather patterns

**ADVENTURE
BACKPACK**

PREPARED BY:

Patryk Ku,
www.CreativeAwl.com



**PLEASE
READ!**

If it wasn't for your support, this pattern wouldn't have come into being, thanks! If you already post pictures of your bag in the social media, I would be invariably glad if you would mention the author. I also encourage you to share your work on our facebook group.

All rights reserved. No content may be shared or reproduced. If you would like to share it, please recommend our facebook group or <https://www.creativeawl.com>

Thank you and have fun!

Patryk

LET'S GO:

PRINT THE PATTERN

01

- Open your pattern in Adobe Acrobat Reader. Set up options of your printer on A4 paper with 0 margins (if needed).
- Every page has a measure - check does it fit.
- Every printed page **MUST HAVE** a border around! If doesn't - move paper left/ right and print again

02

VIDEO TUTORIAL:

<https://youtu.be/EJu8F11vKMw>

Cutting patterns:

https://youtu.be/2TNUI_TIk64

03

GIVE A SMILE TO OTHER PEOPLE!

Give a ready product to you family or freind. Give them a smile :)))

Also Check www.CreativeAwl.com for more patterns

04

JOIN OUR FB GROUP

Go there to share your work. Also get more DIY&ideas. We will support you & answer all questions.

<https://www.facebook.com/groups/CreativeAwlPatterns>

YOU NEED

TOOLS

- sharp knife
- 1,2-1,5mm hole puncher or pricking irons or awl
- hammer
- 2 needles
- paper tape
- a home printer

MATERIALS

- 1 square meter of leather
- 2 x 20mm buckles
- 4 x 20mm d-rings
- zipper (15 cm | 5.9")
- 0,8-1 mm thread



SHARE YOUR WORK

<https://www.facebook.com/groups/CreativeAwlPatterns>

If you got ANY problem,- don't be shy to ask directly on Etsy or facebook

Women's leather backpack:

pages 1 - 26

-The number in the circle shows which holes are to be connected. Example: ①

-Numbers 1, 2, 3 (...) without a circle indicate where the piece lies in the overview drawing.

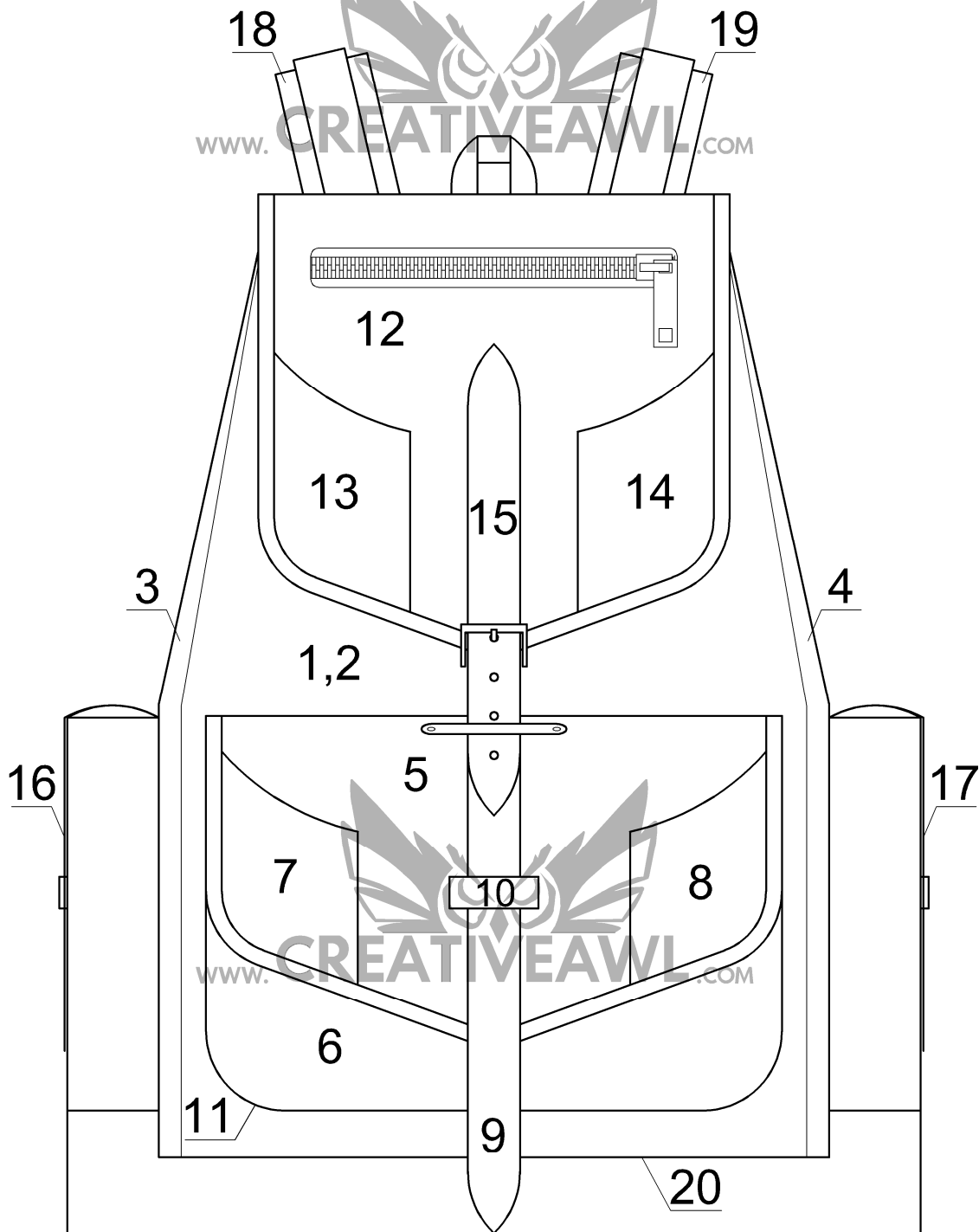

11 in
8,5 in

A4

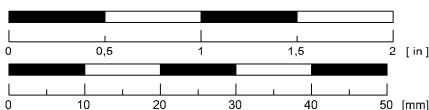

Sketch drawing

Leather needed for a women's
backpack:

about 1,02 m²

860 mm (34.4 in)

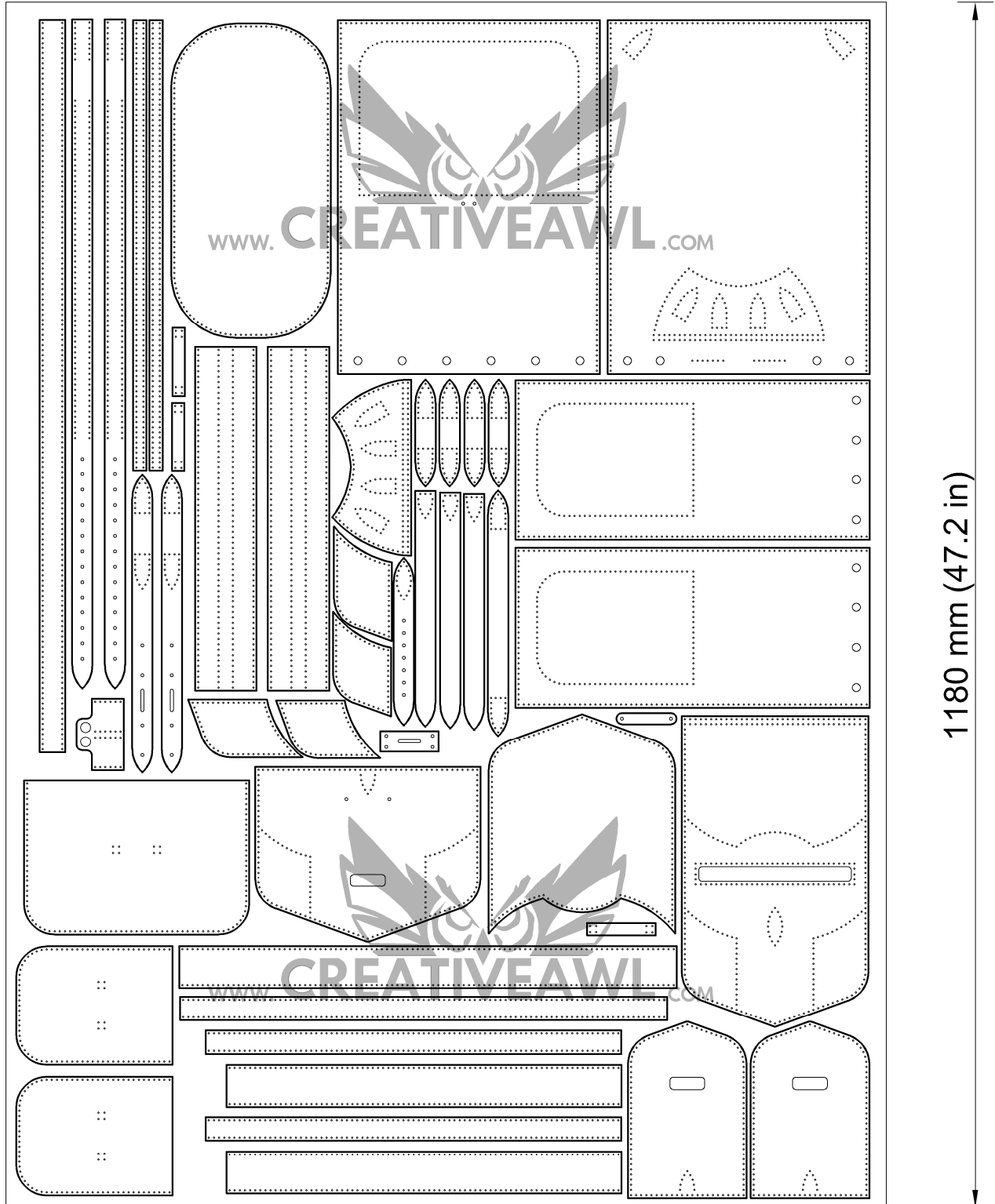

Sketch drawing
Bill of materials

Leather women's backpack

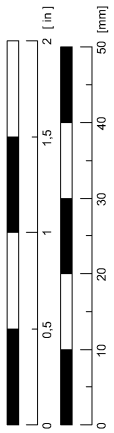

A4
11 in
8.5 in
LETTER

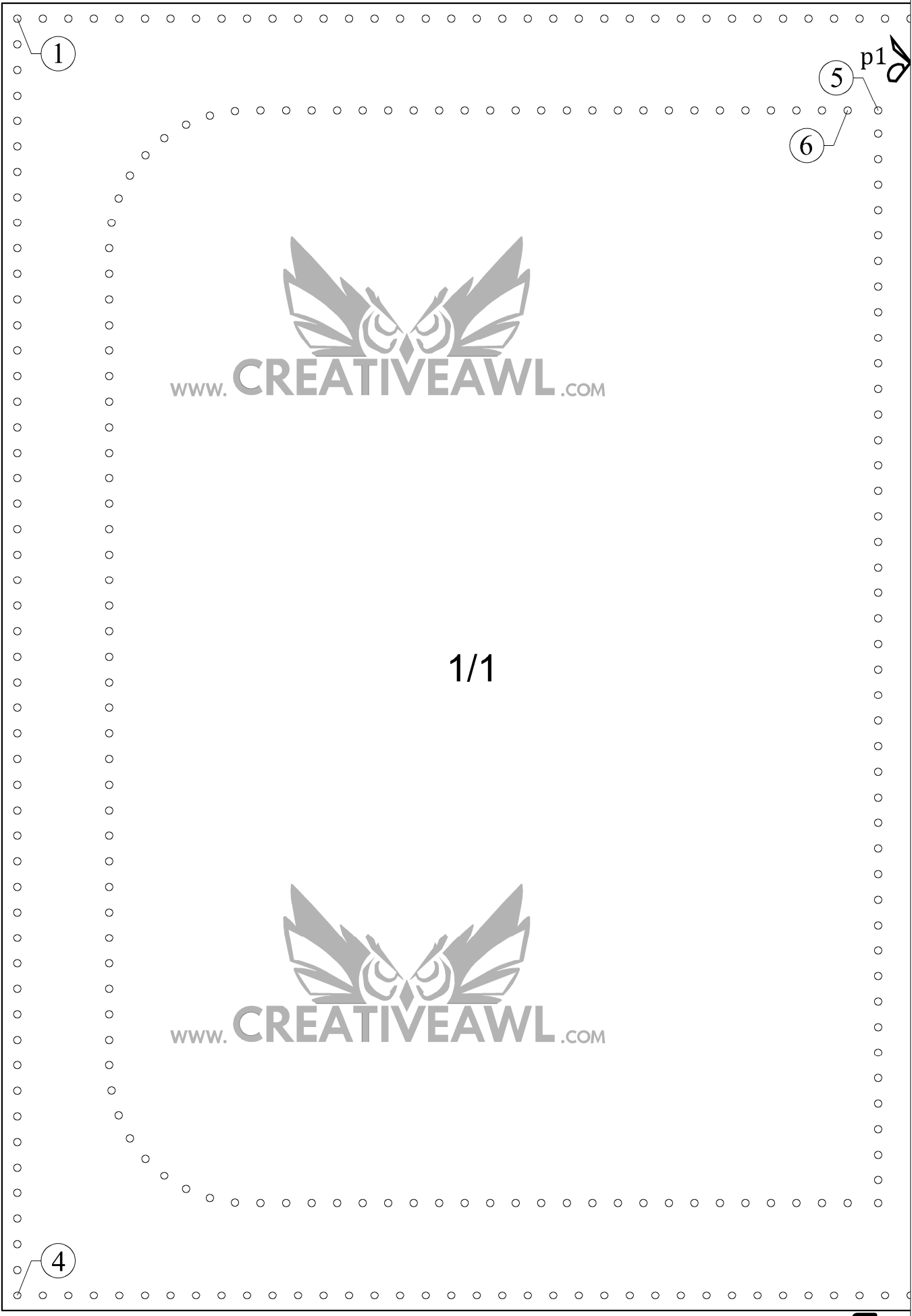

p1



1/2



18

Leather women's backpack

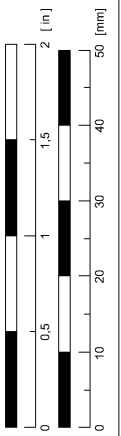

Leather women's backpack

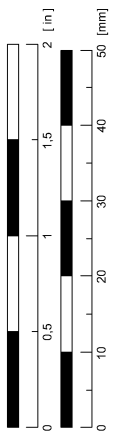

A4

11 in
8.5 in
LETTER

3

19



2/1

p2

20



2

p2

2/2



21

23

24

22



13



35

36



Leather women's backpack

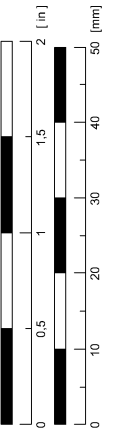

A4
11 in
8,5 in
LETTER



Leather women's
backpack

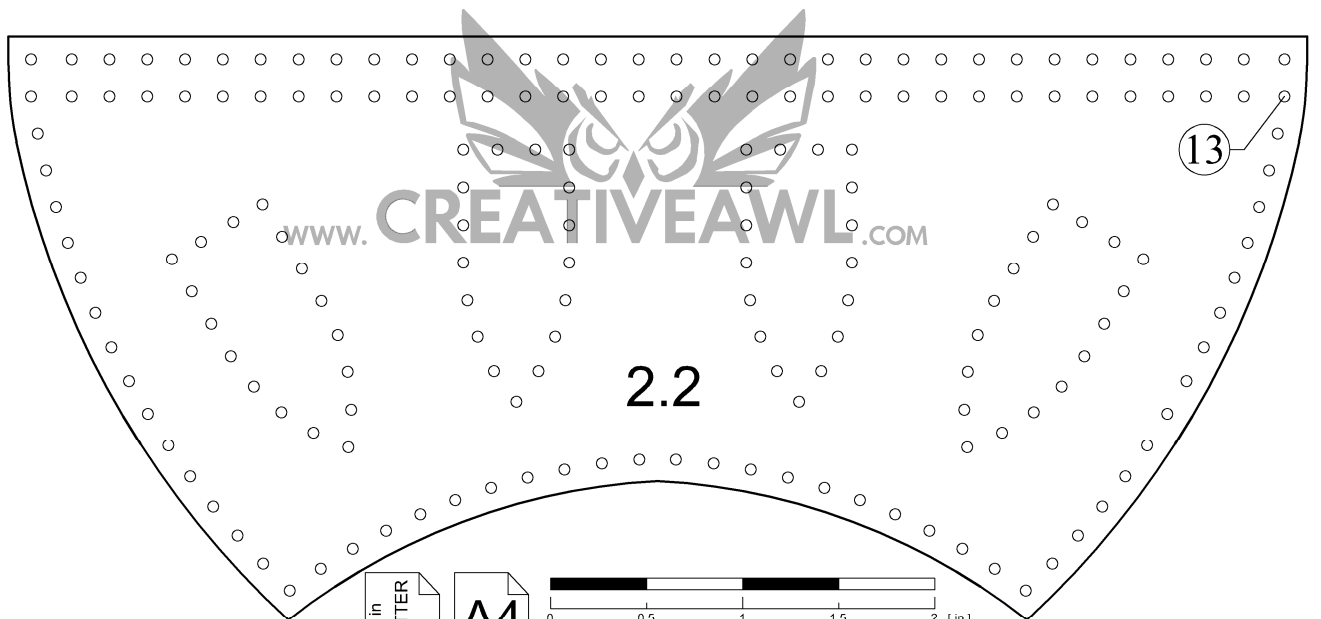
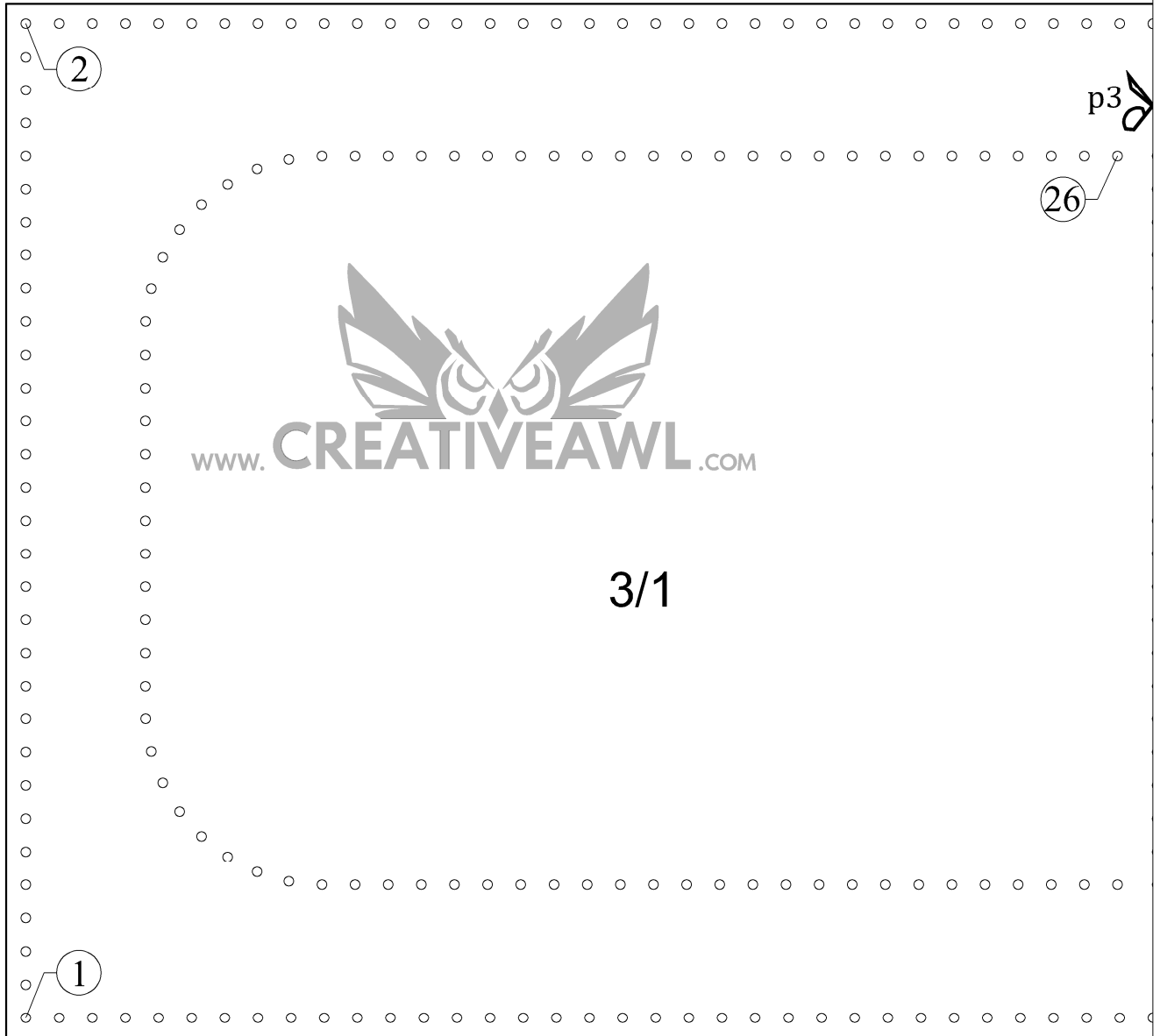

11 in
LETTER
8.5 in

A4

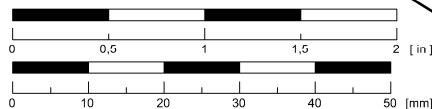

p3
25



3/2

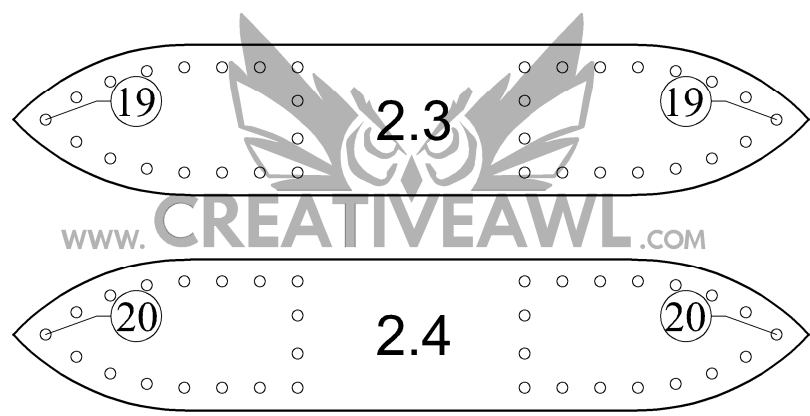

11 in
LETTER
8,5 in

A4

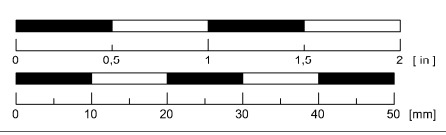

Leather women's
backpack



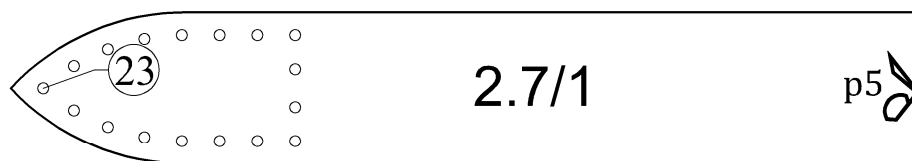
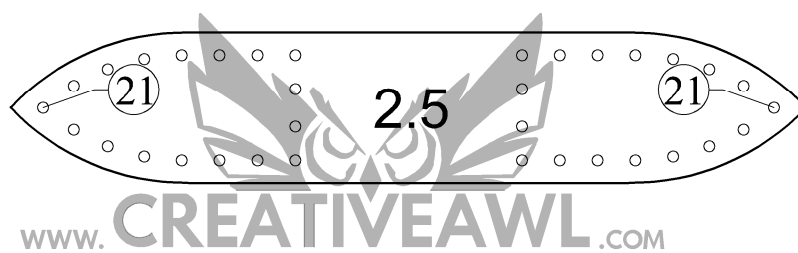
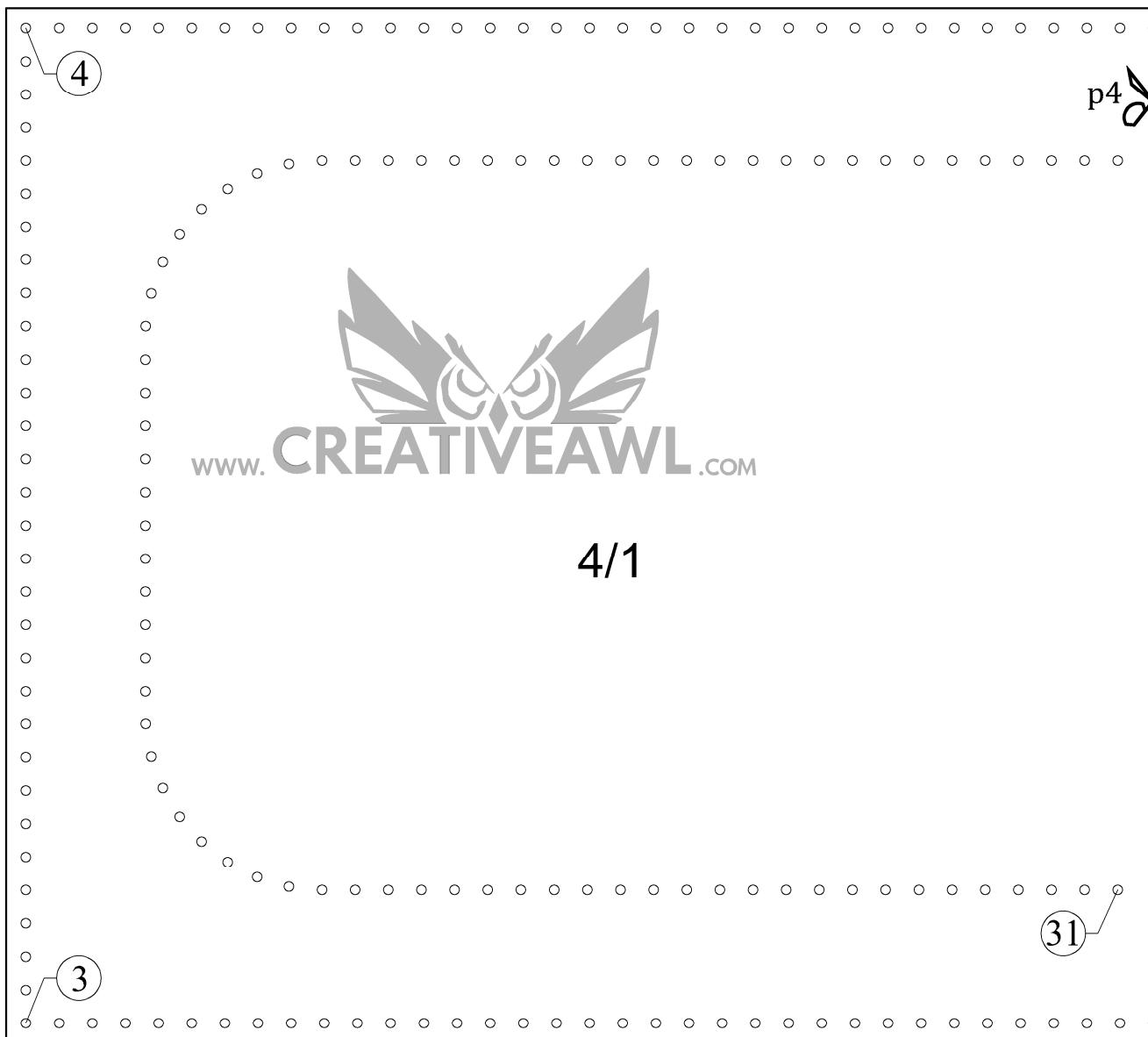

11 in
LETTER
8.5 in

A4

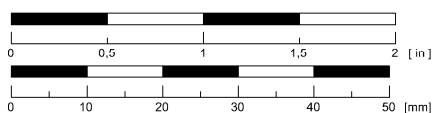

Leather women's
backpack

p4



4/2

30

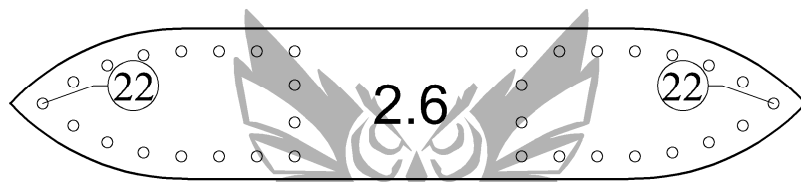

p5

2.7/2

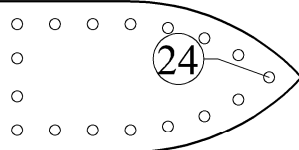

11 in
LETTER
8.5 in

A4

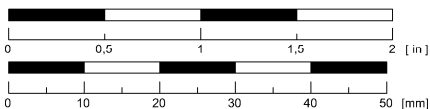

Leather women's
backpack

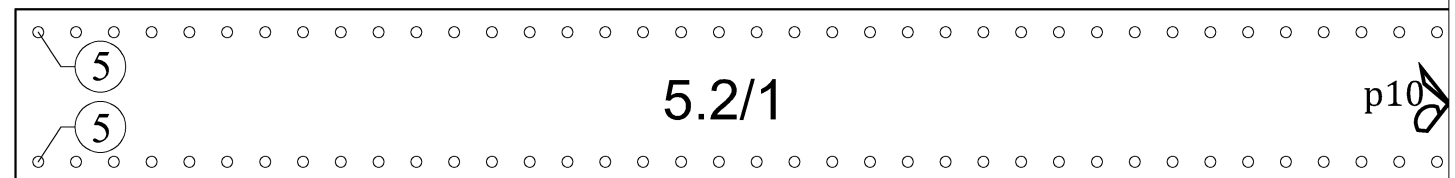
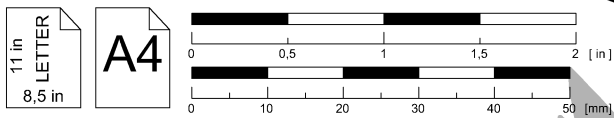
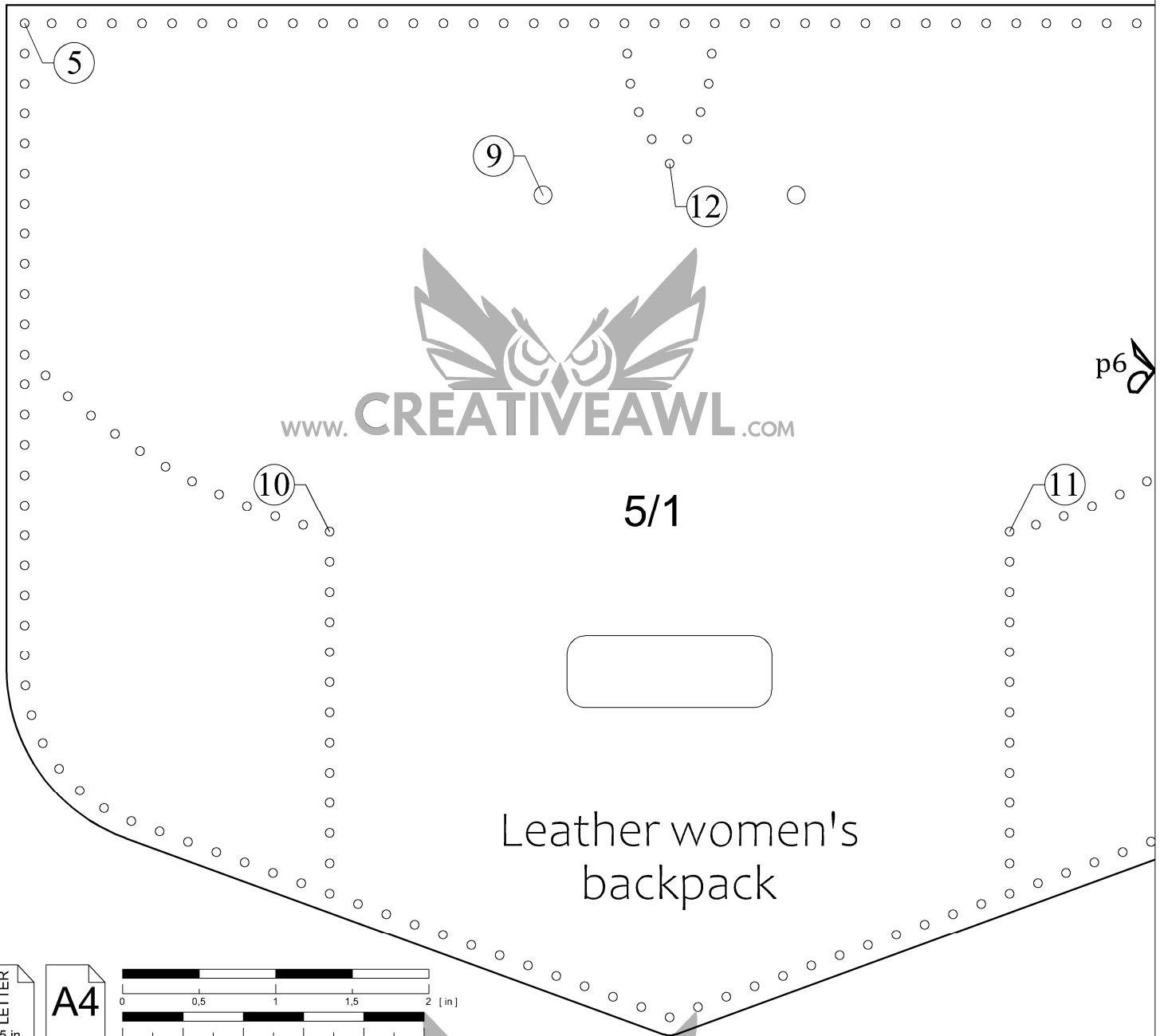

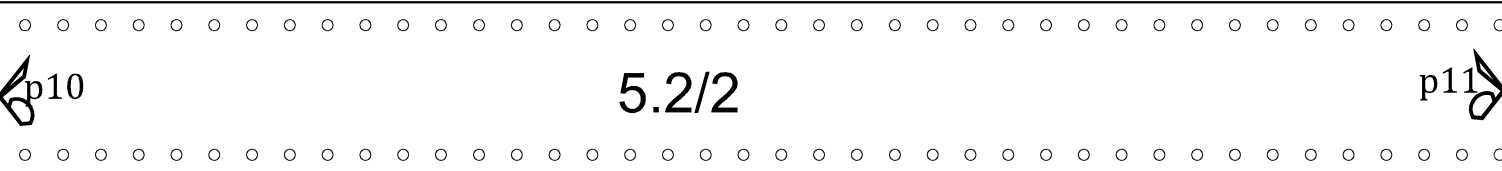
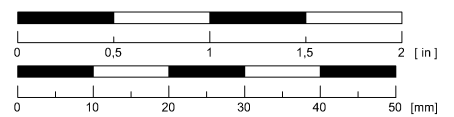
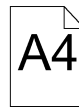
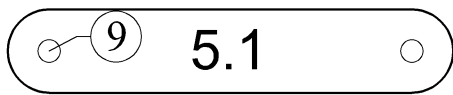
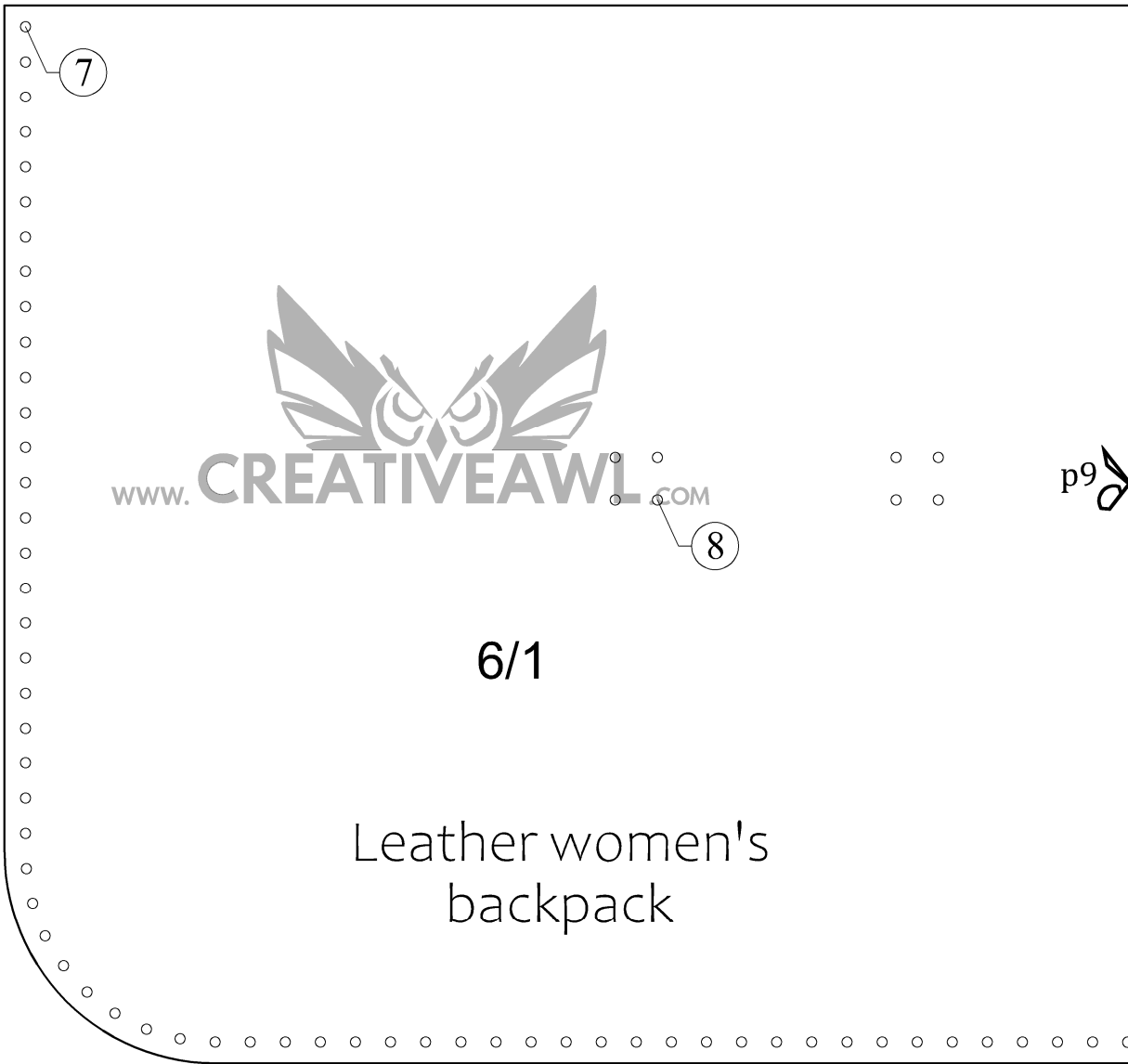
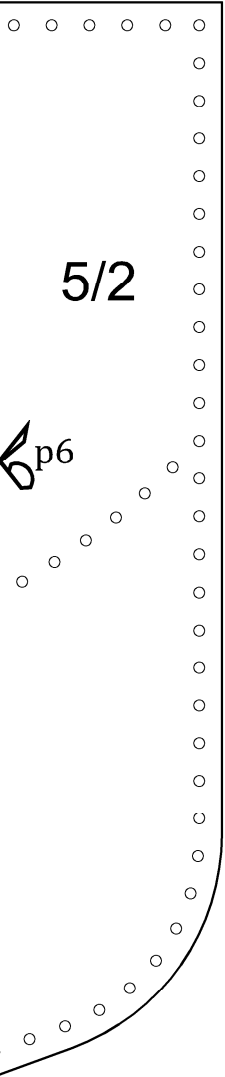

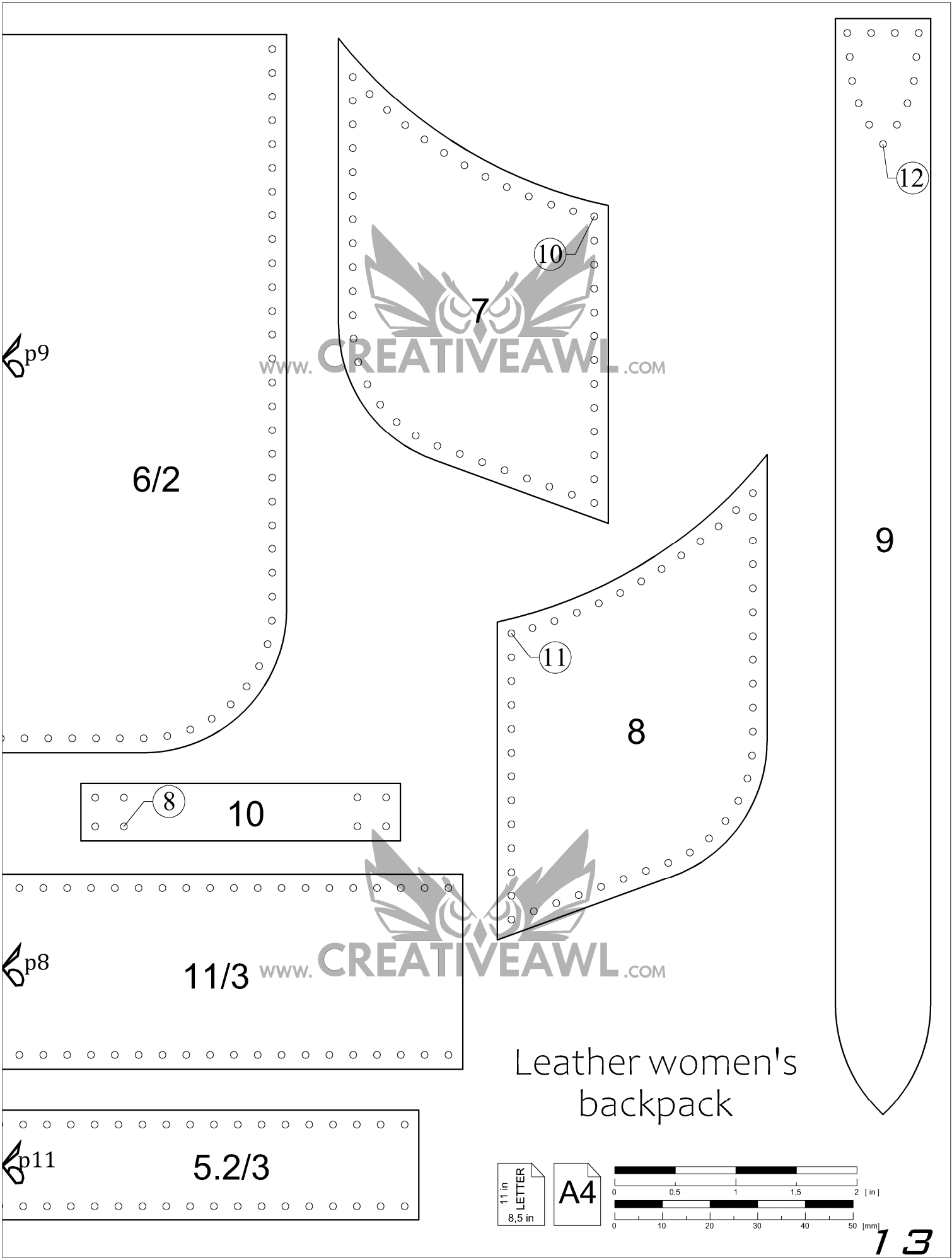

p9

6/2

7

10

12

www.CREATIVEAWL.COM

9

8 10

11

8

p8

11/3

www.CREATIVEAWL.COM

Leather women's backpack

p11

5.2/3

11 in LETTER 8,5 in

A4

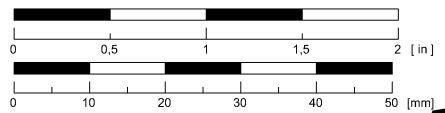

Leather women's
backpack

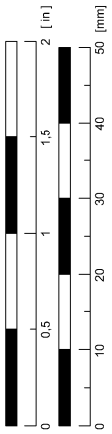

A4

LETTER
8.5 in



p12

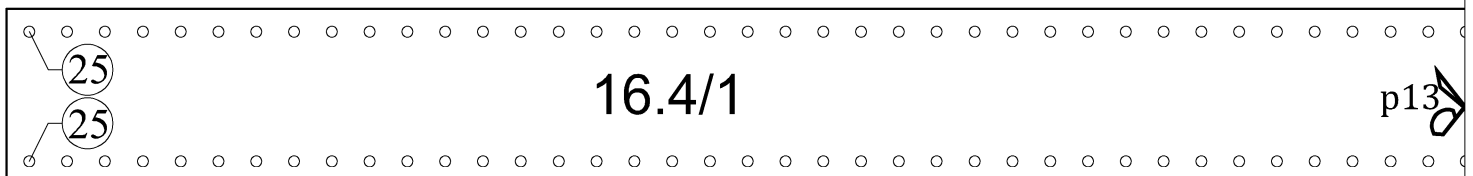

p13

Leather women's
backpack

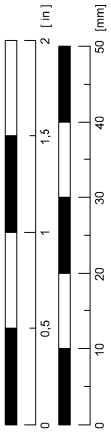

A4

LETTER
11 in
8.5 in

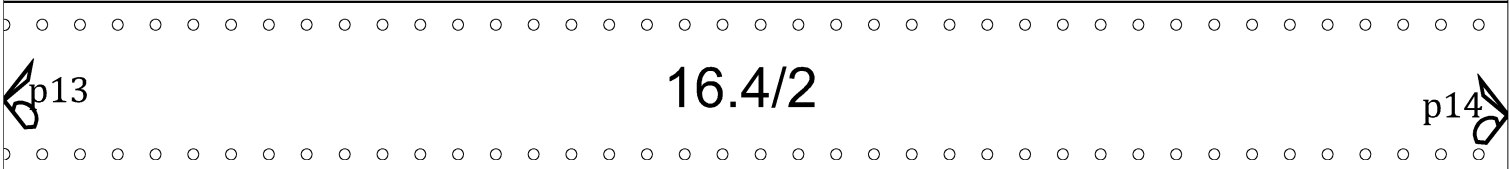
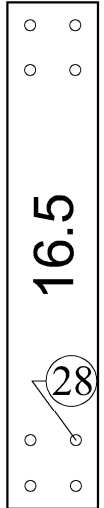
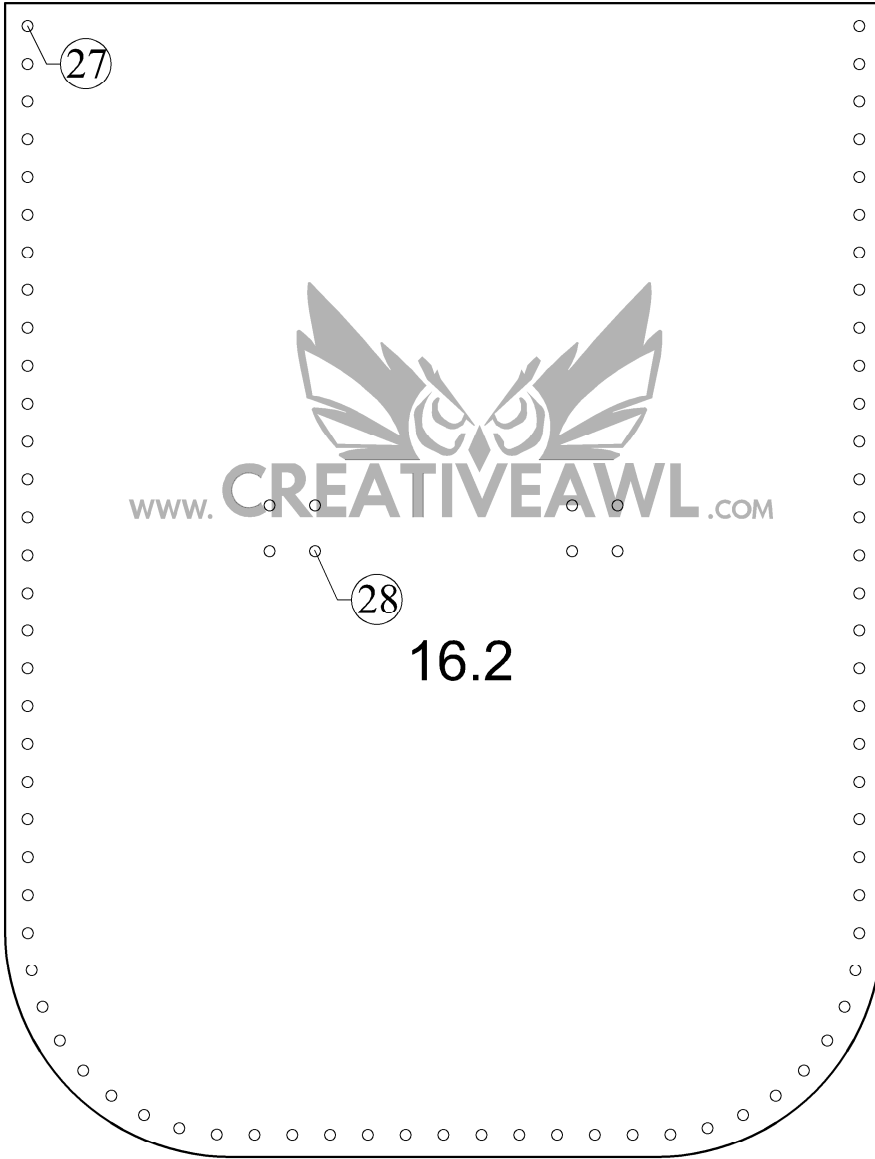



16.6

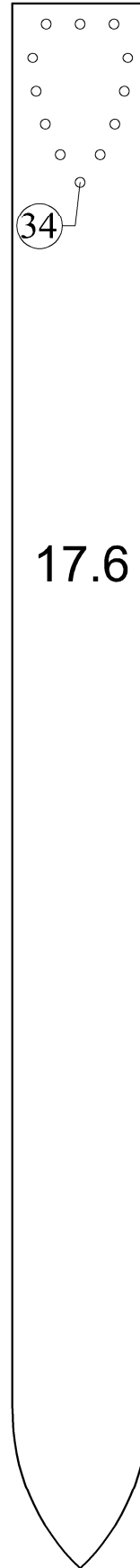

17.6

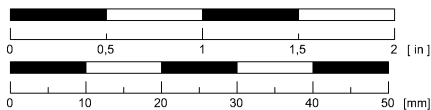
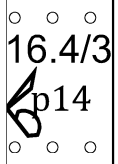

Leather women's
backpack

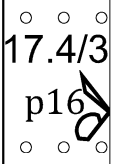

Leather women's
backpack

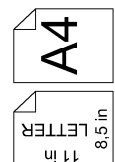
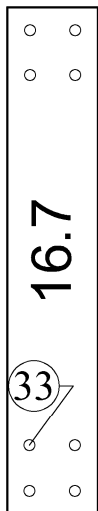

p15

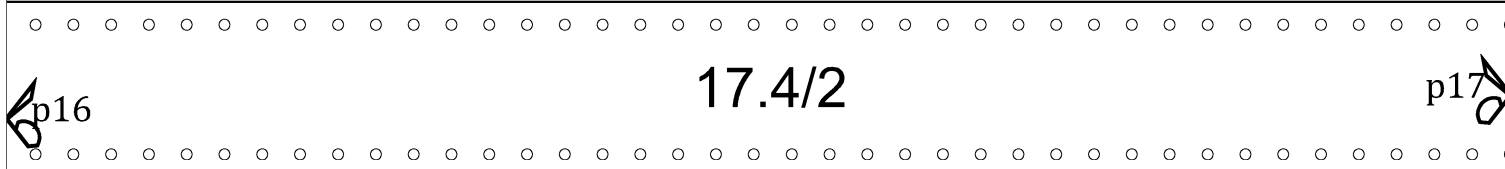

p16

p17



Leather women's
backpack

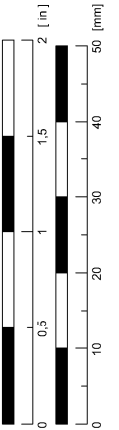

A4

11 in
LETTER
8.5 in



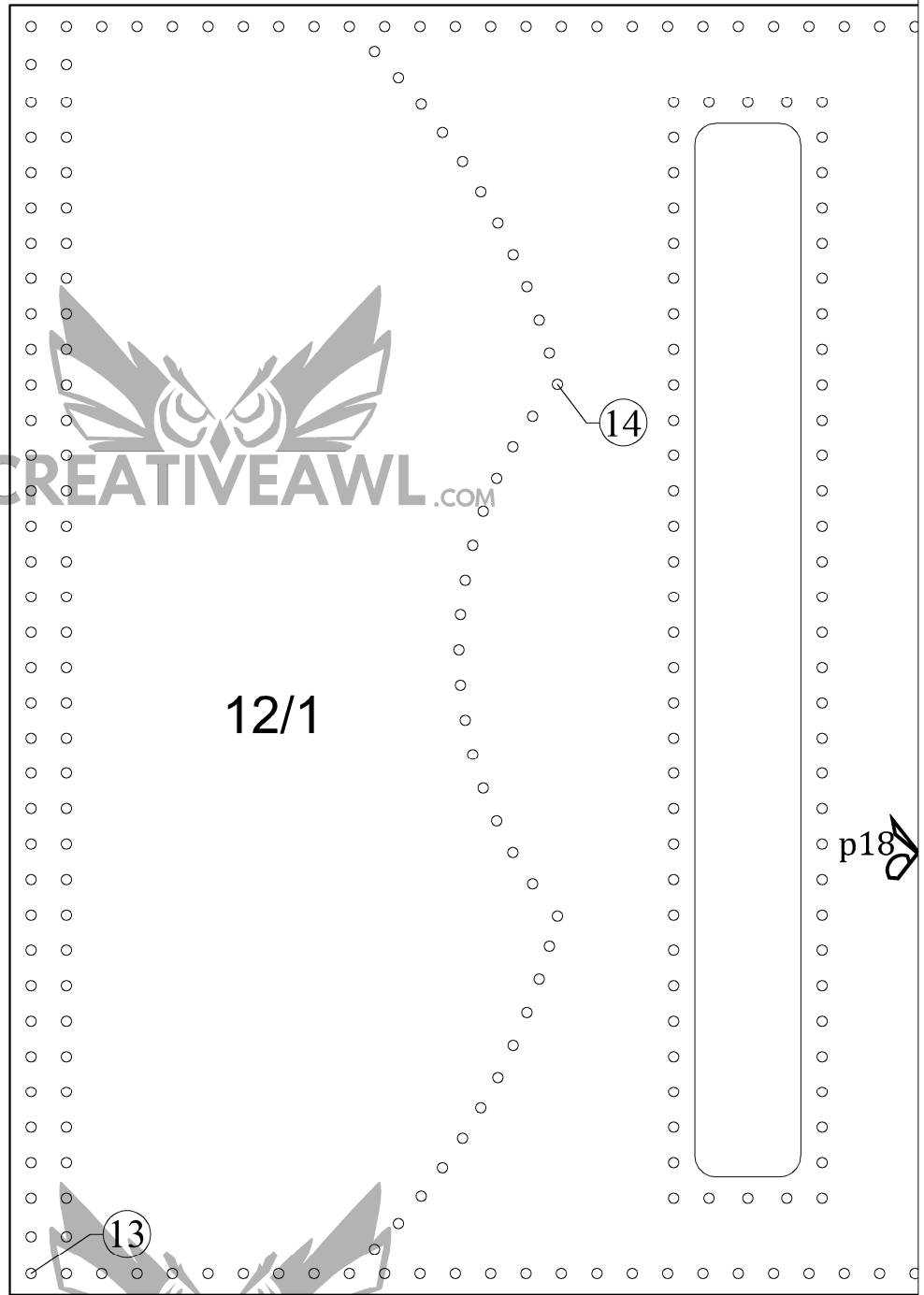

12/1

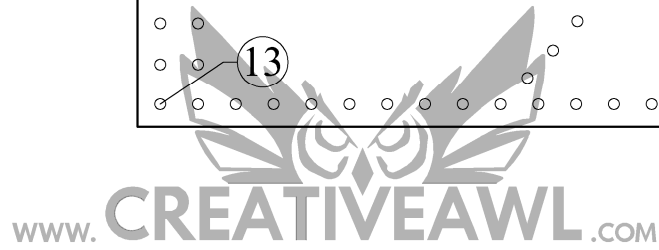

Leather women's backpack

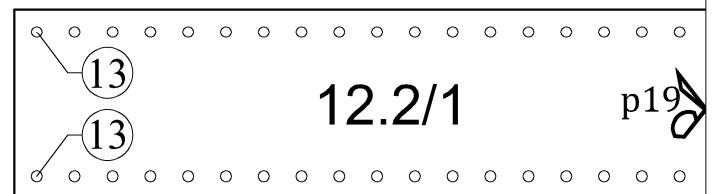

12.2/1

11 in
LETTER
8.5 in

A4

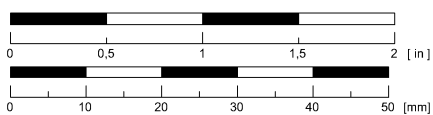

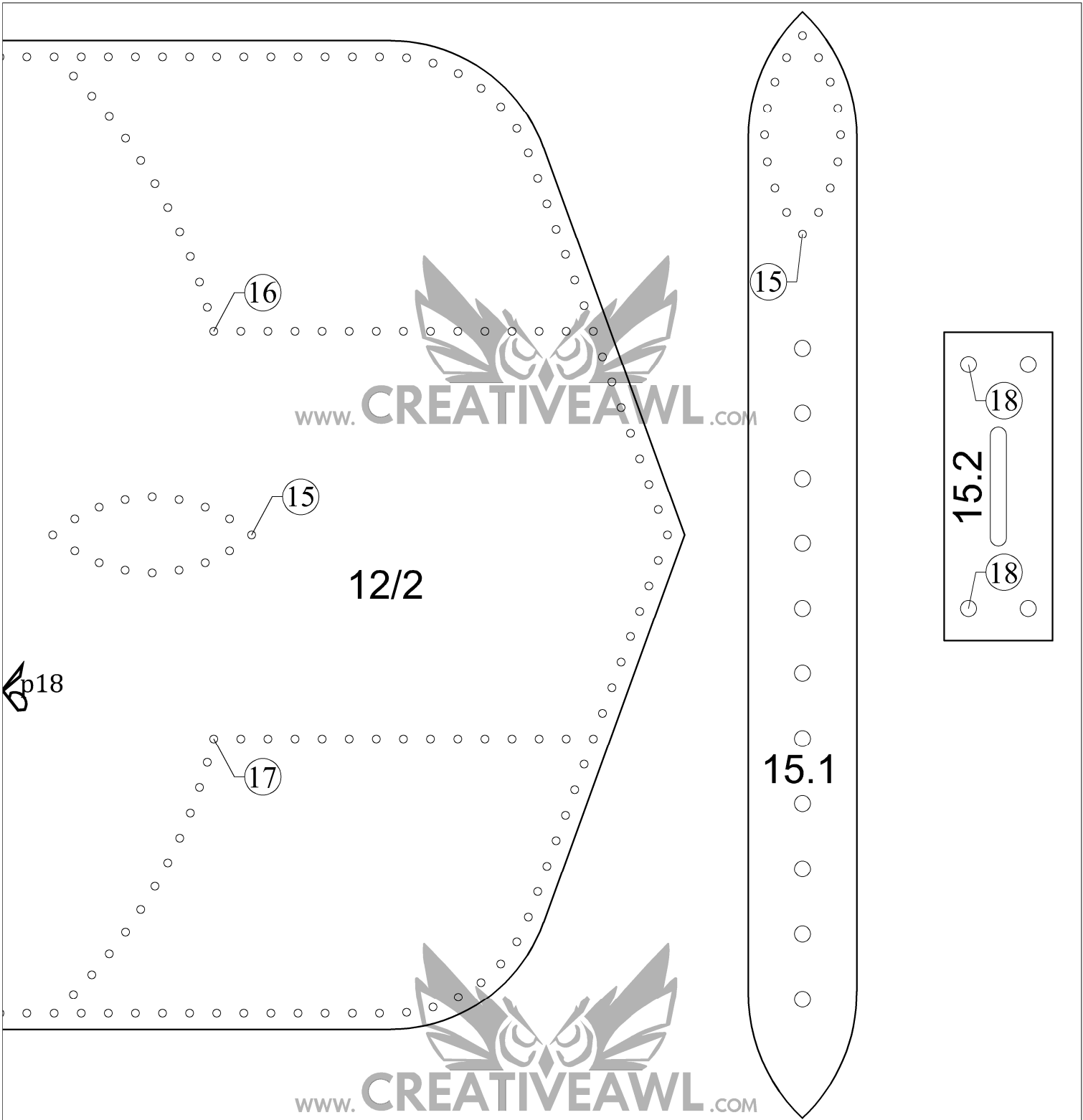

Leather women's
backpack

11 in
LETTER
8,5 in

A4

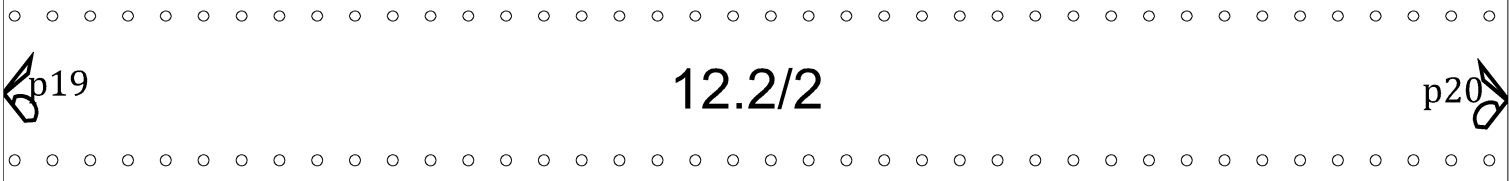
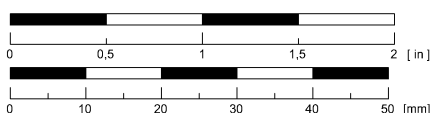

11 in
LETTER
8,5 in

A4

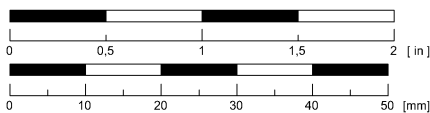

Leather women's backpack

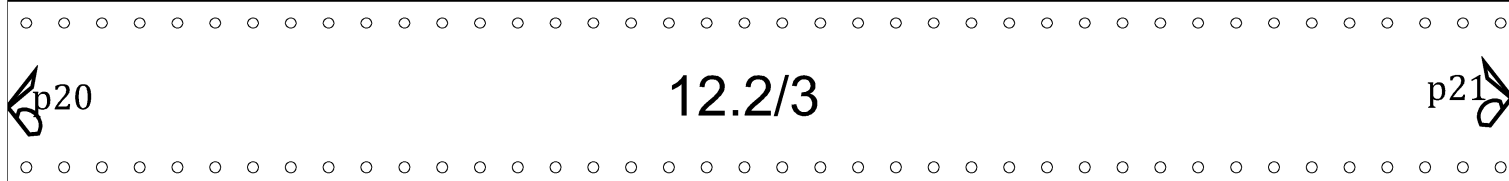
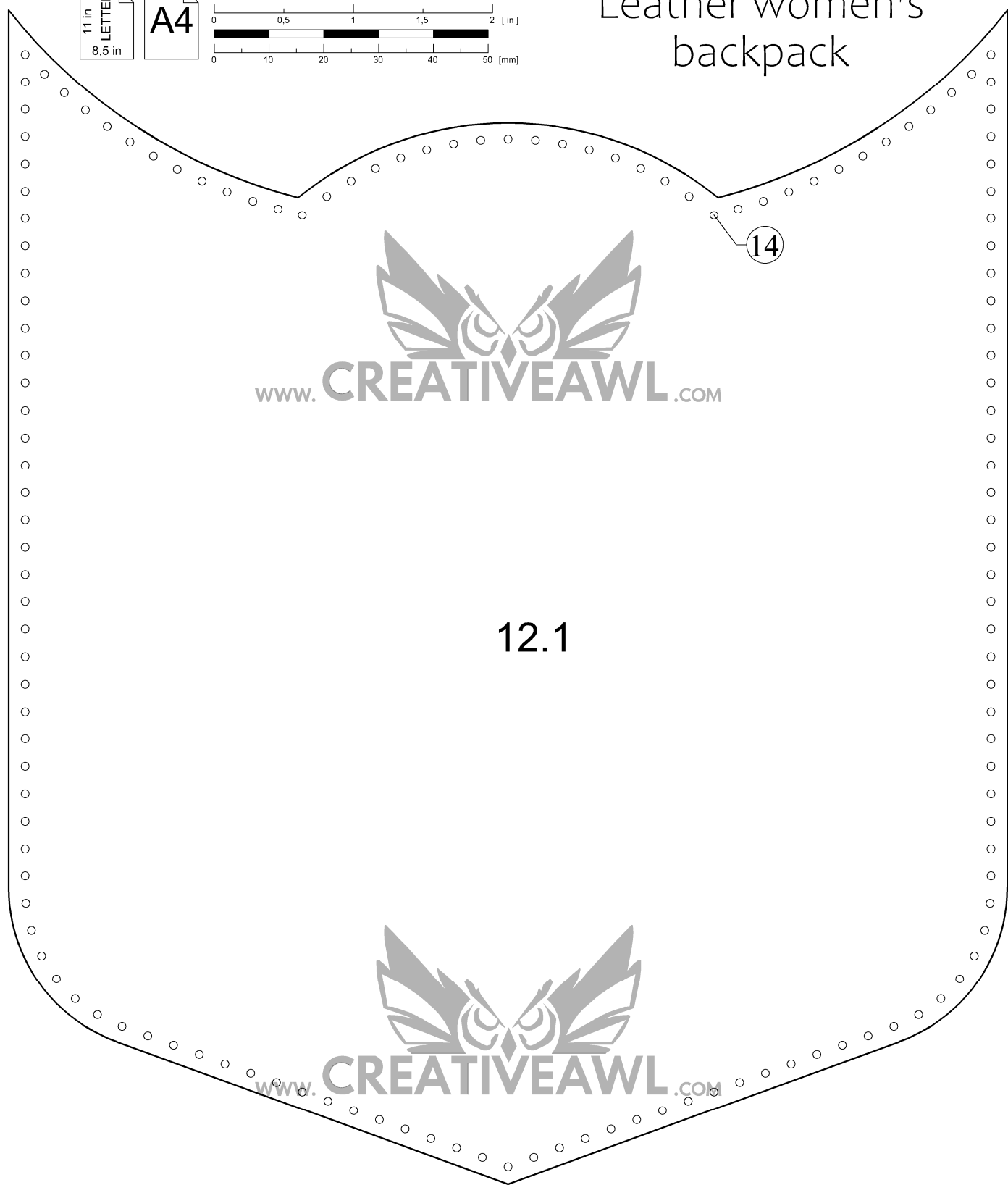

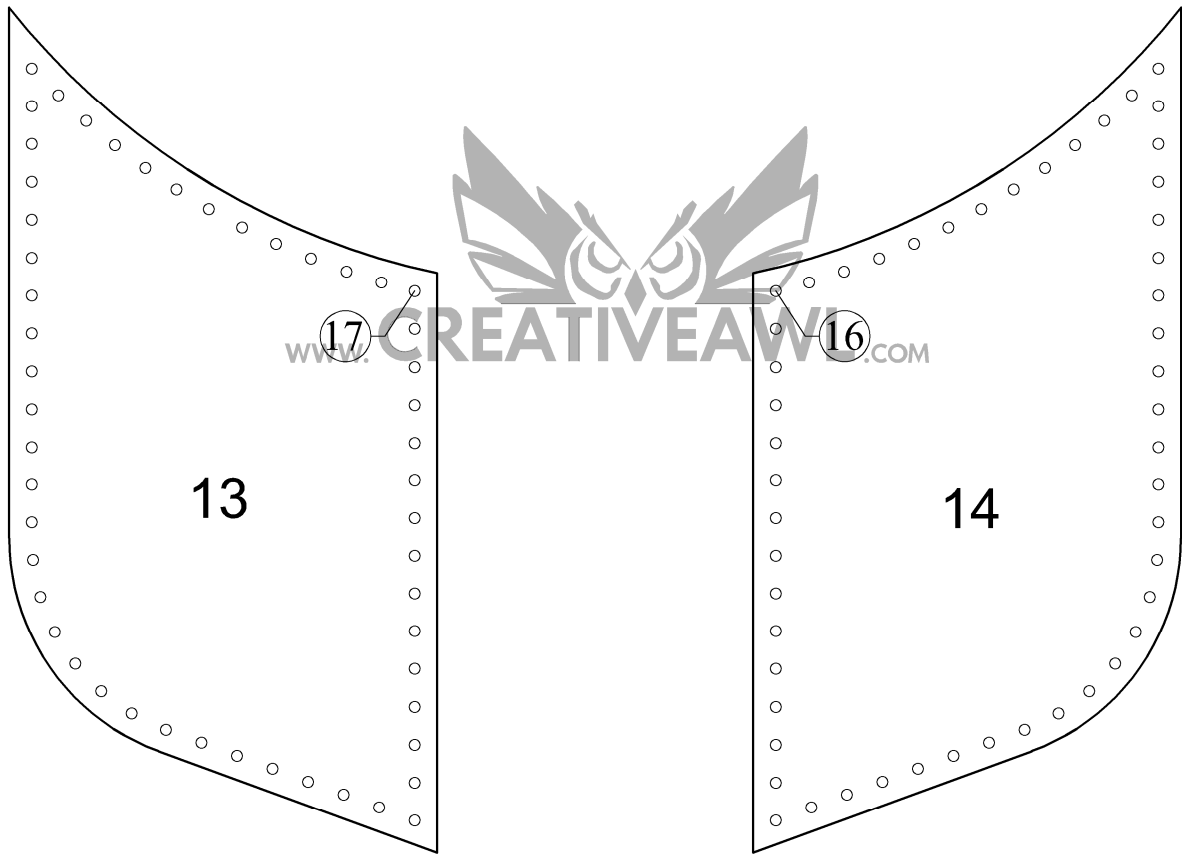

11 in
LETTER
8,5 in

A4

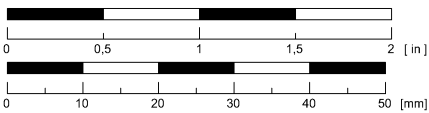

p21

12.2/4

Leather women's
backpack



20/1

p22

1

Leather women's
backpack

11 in
LETTER
8.5 in

A4

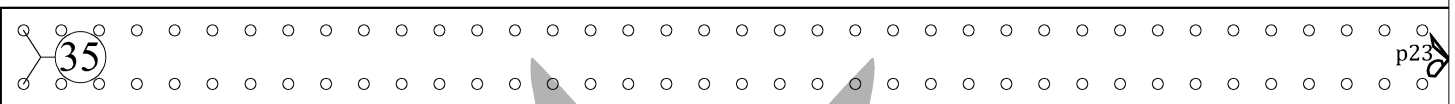
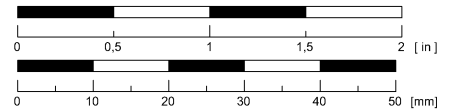

p23

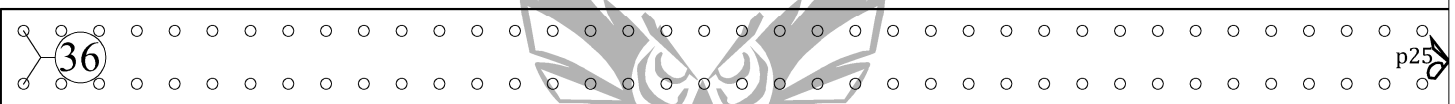

p25

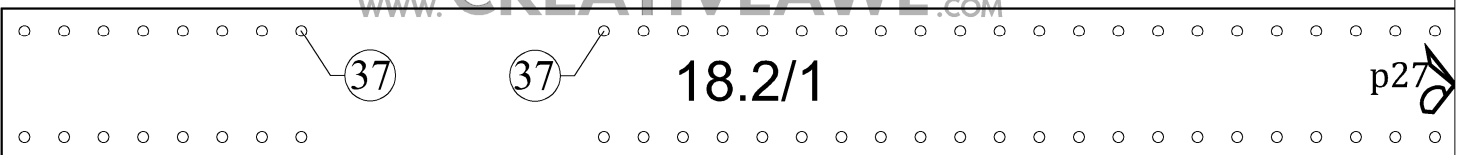

p27

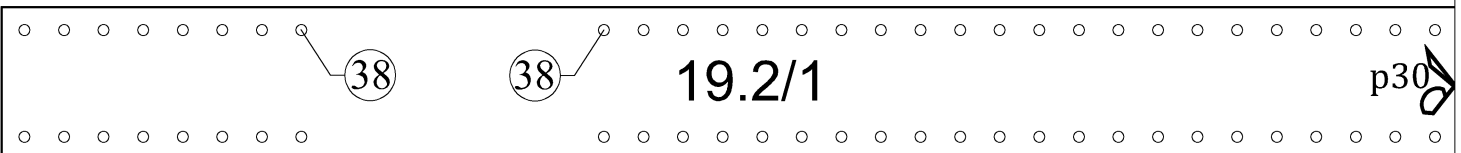

p30



p22

20/2

3

4

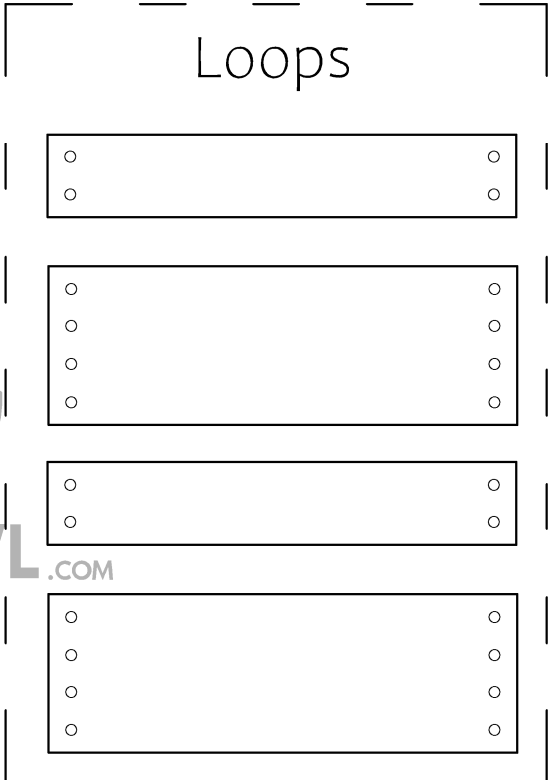

Loops



Leather women's
backpack

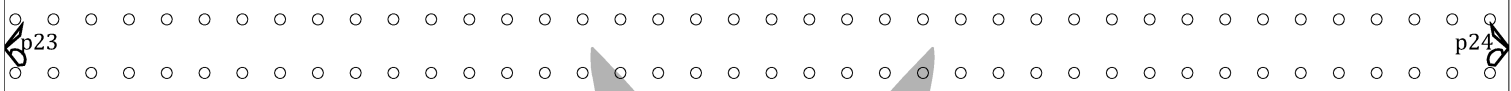
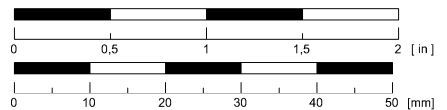
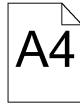
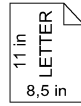

p23

p24

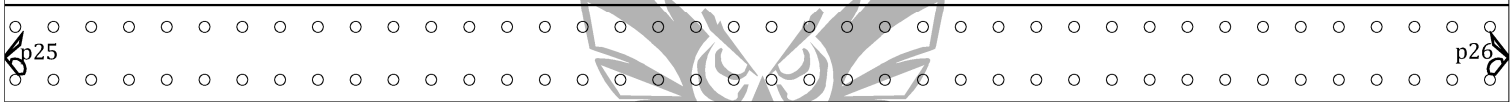

p25

p26



p27

18.2/2

p28

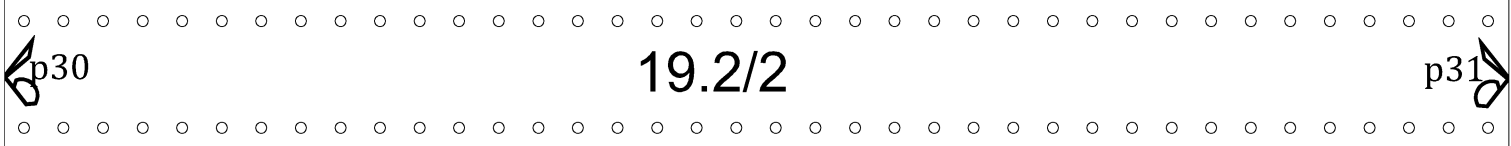

p30

19.2/2

p31

Leather women's
backpack

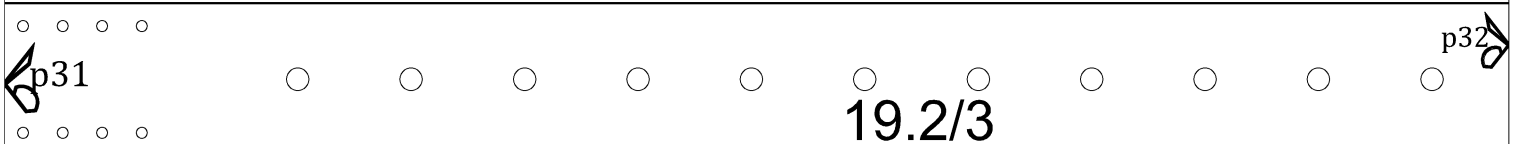
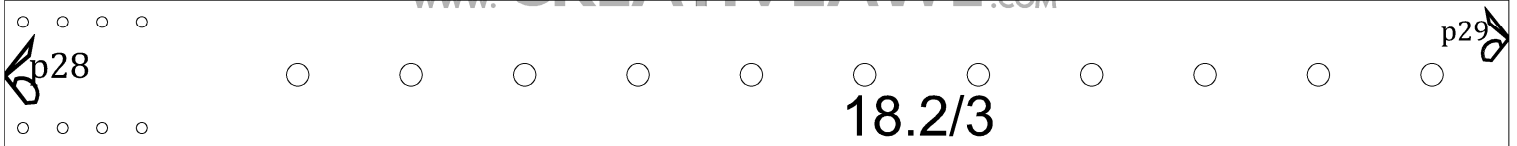
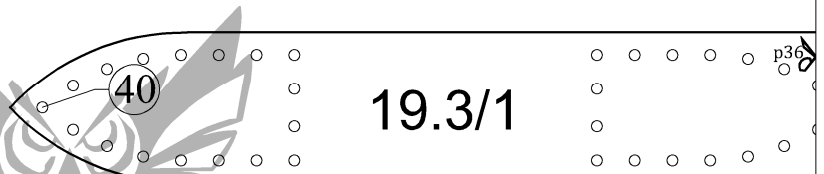
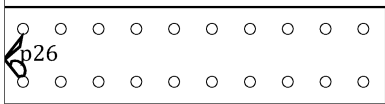
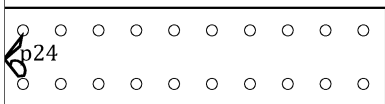
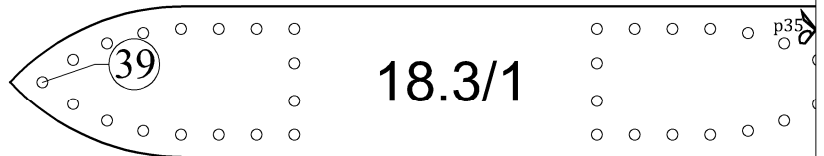
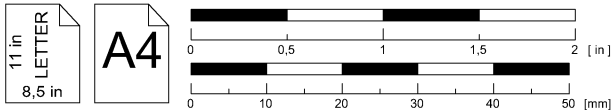
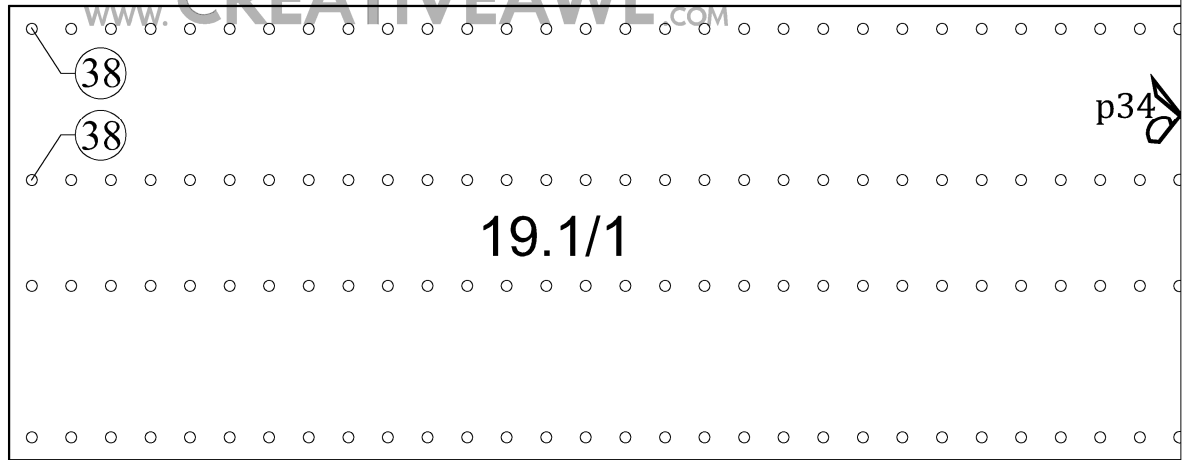
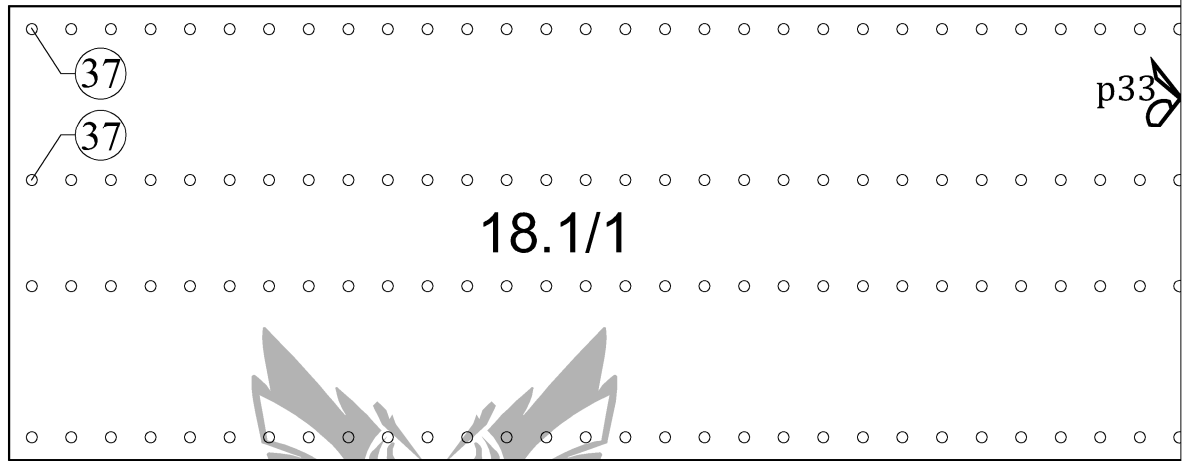

p33

18.1/2

p34

19.1/2

p35

39

18.3/2

p36

40

19.3/2

p29

18.2/4

p32

19.2/4

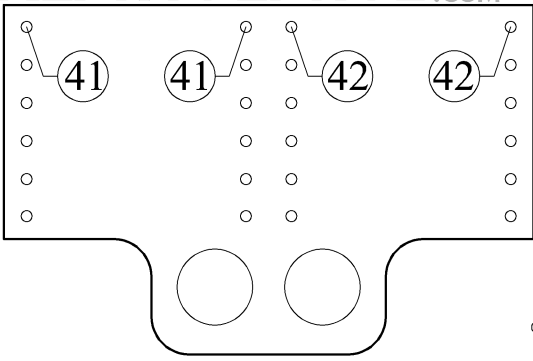

www.CREATIVEAWL.COM

Leather women's backpack

11 in
LETTER
8,5 in

A4

