



CREATIVE AWL

leather patterns

OLDSCHOOL BACKPACK

PREPARED BY:

Patryk Ku,
www.CreativeAwl.com



**PLEASE
READ!**

If it wasn't for your support, this pattern wouldn't have come into being, thanks! If you already post pictures of your bag in the social media, I would be invariably glad if you would mention the author. I also encourage you to share your work on our facebook group.

All rights reserved. No content may be shared or reproduced. If you would like to share it, please recommend our facebook group or <https://www.creativeawl.com>

Thank you and have fun!

Patryk

LET'S GO:

PRINT THE PATTERN

01

- Open your pattern in Adobe Acrobat Reader. Set up options of your printer on A4 paper with 0 margins (if needed).
- Every page has a measure - check does it fit.
- Every printed page **MUST HAVE** a border around! If doesn't - move paper left/ right and print again and check the settings

02

VIDEO TUTORIAL:

<https://youtu.be/4a7aPdr81i8>

Cutting patterns:

https://youtu.be/2TNUI_TIk64

03

GIVE A SMILE TO OTHER PEOPLE!

Give a ready product to you family or freind. Give them a smile :)))

Also Check www.CreativeAwl.com for more patterns

04

JOIN OUR FB GROUP

Go there to share your work. Also get more DIY&ideas. We will support you & answer all questions.

<https://www.facebook.com/groups/CreativeAwlPatterns>

YOU NEED

TOOLS

- sharp knife
- 1-1,5 and 3, 4, 8, 10mm hole punchers
- hammer
- 2 needles
- paper tape
- a home printer

MATERIALS

- about 0,75 square meter of leather (3 -6oz)
- 0,8mm waxed thread
- few rivets and few with longer feet
- 4x 25mm d-rings
- 2x 25mm belt buckles
- 5mm ball head stud



SHARE YOUR WORK

<https://www.facebook.com/groups/CreativeAwlPatterns>

If you got ANY problem,- don't be shy to ask directly on Etsy or facebook

Oldschool backpack:

pages 5 - 24

-The number in the circle shows which holes are to be connected. Example: ①

-Numbers 1, 2, 3 (...) without a circle indicate where the piece lies in the overview drawing.

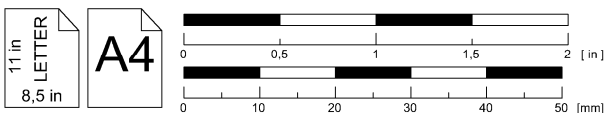
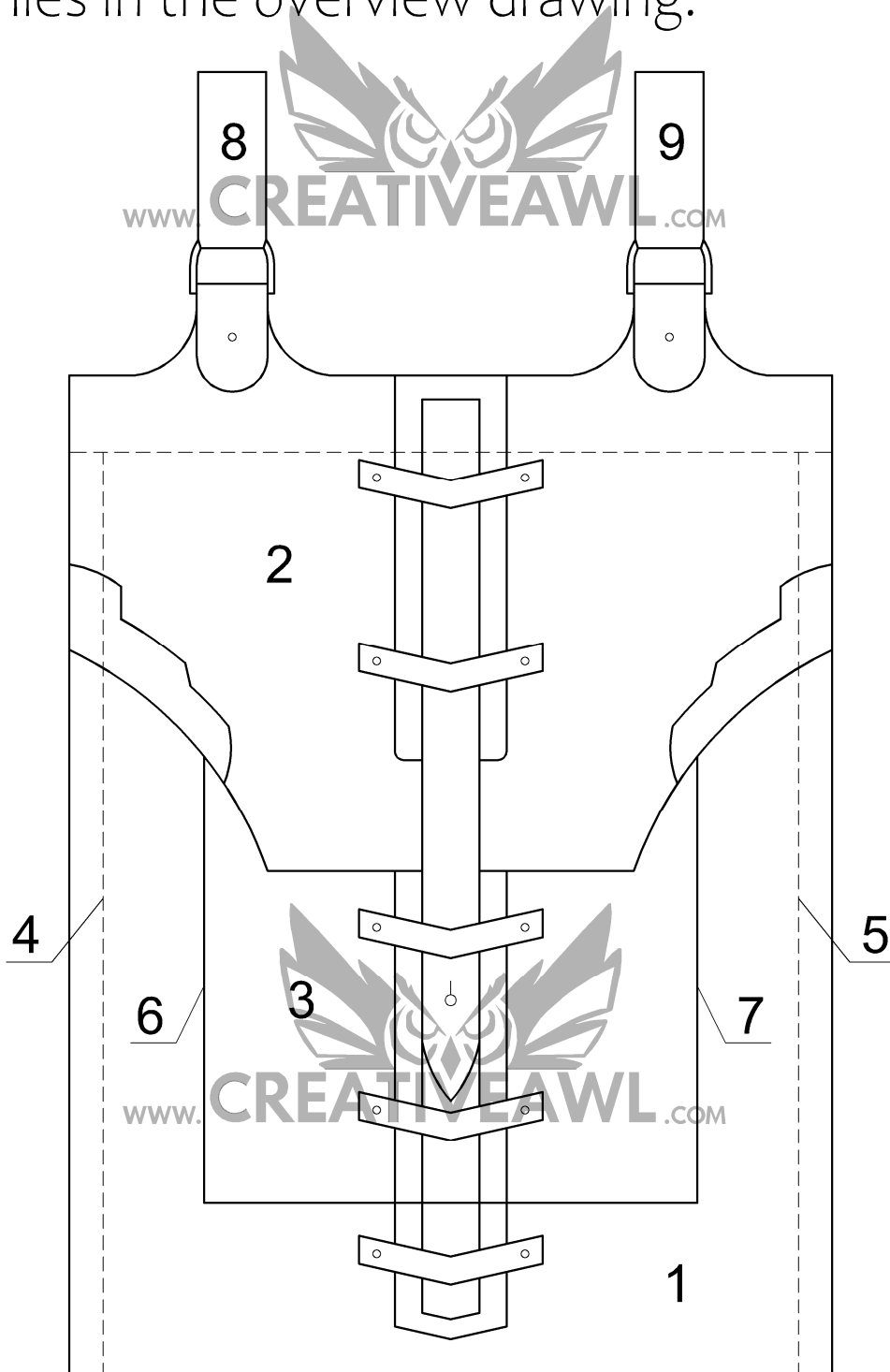

Sketch drawing

Leather needed for a oldschool
backpack:

about 0,75 m2

840 mm (33.6 in)

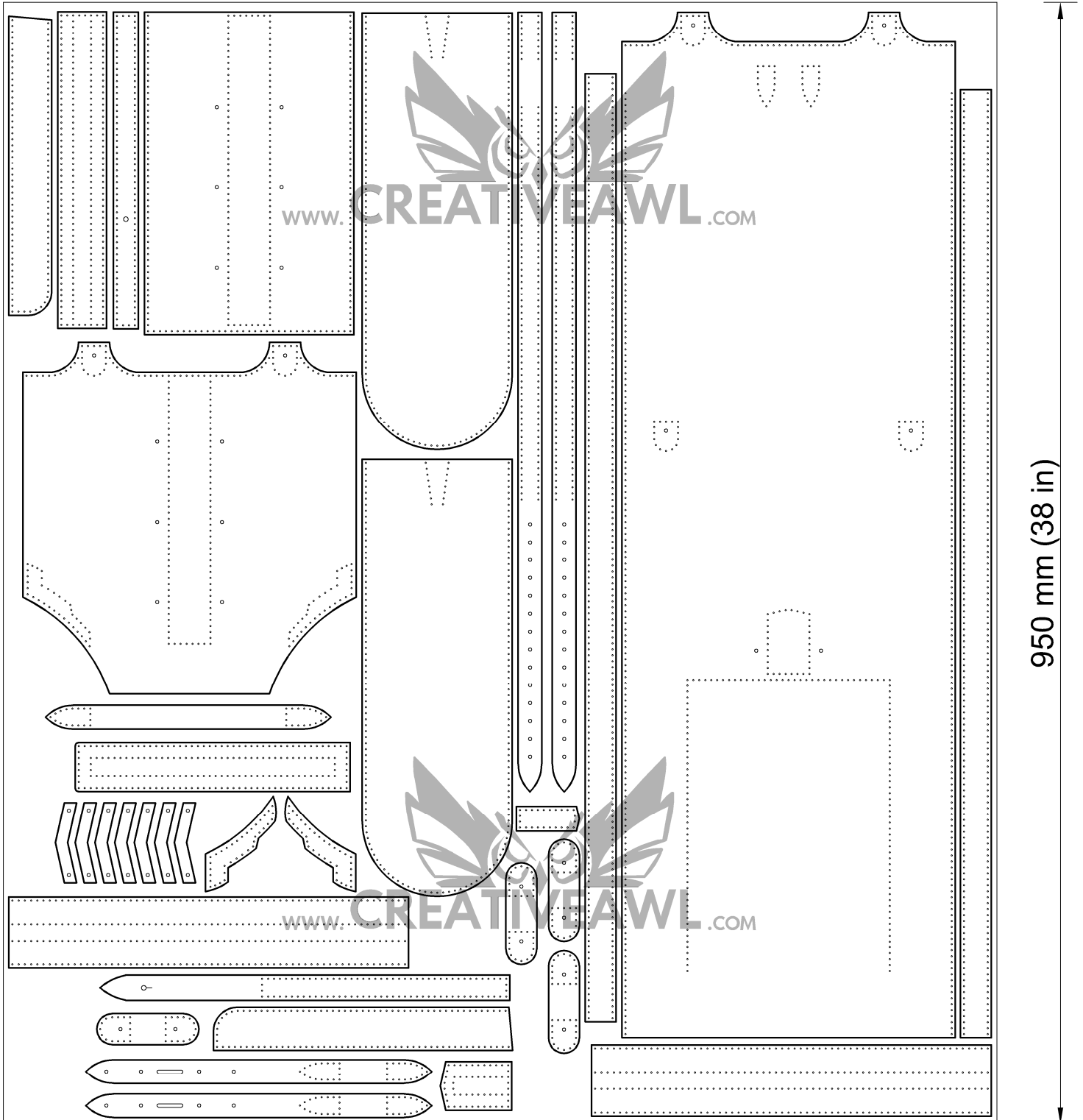

950 mm (38 in)

Sketch drawing
Bill of materials

11 in
LETTER
8,5 in

A4

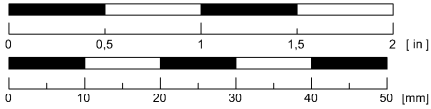

Oldschool backpack

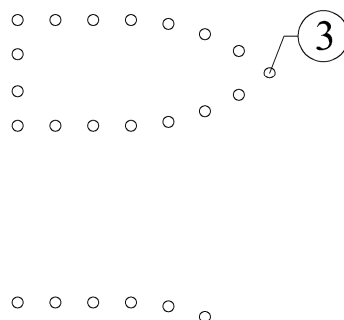
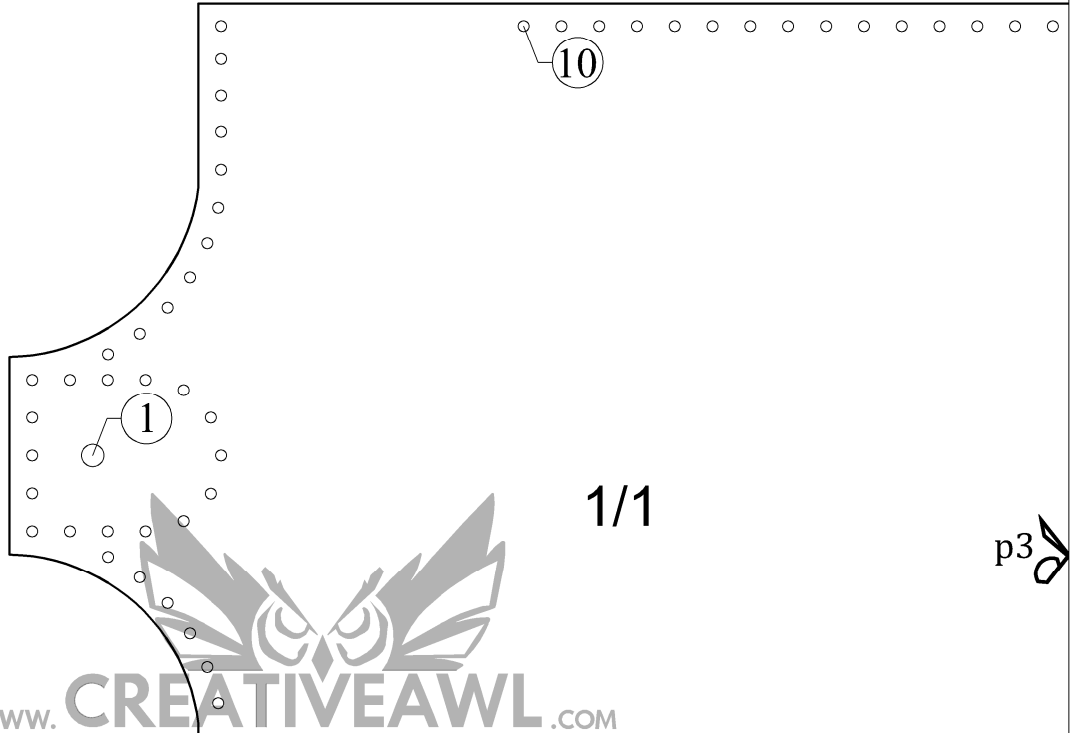
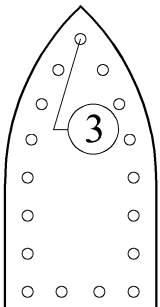
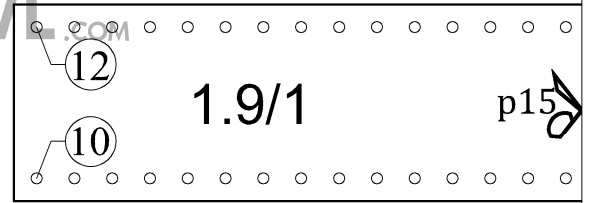
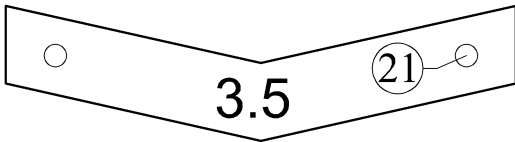
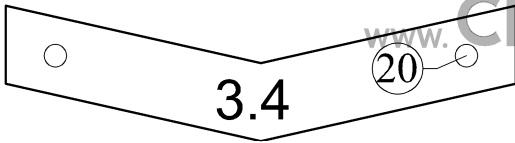

p1

p2

7

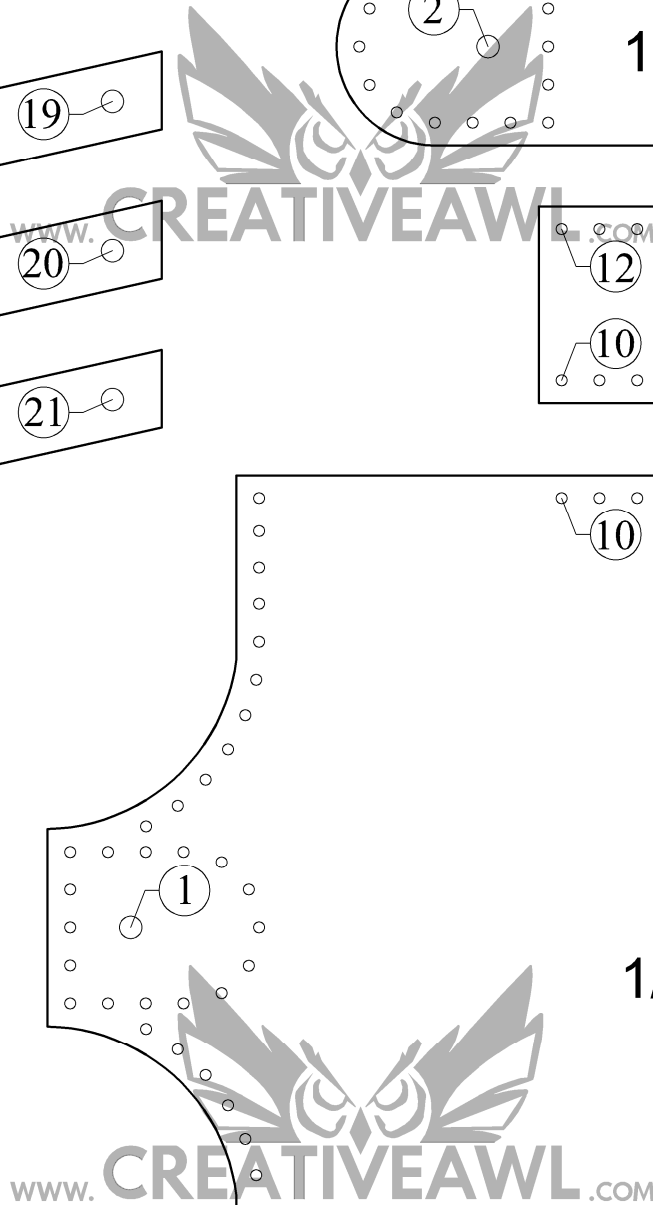

11 in
LETTER
8,5 in

A4

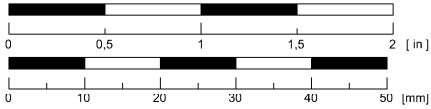

Oldschool backpack



p15

1.9/2

p16

p3

1/2

p6

www.CREATIVEAWL.COM

p5

8

11 in
LETTER
8,5 in

A4

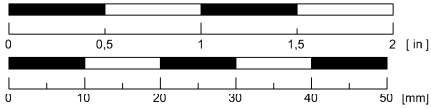

Oldschool backpack

1.3

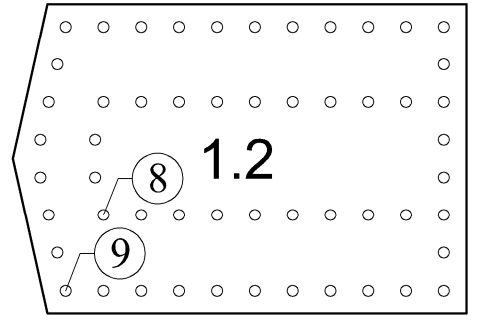

www.CREATIVEAWL.COM



p16

1.9/3



p17



p6

1/3



www.CREATIVEAWL.COM



p9



p8

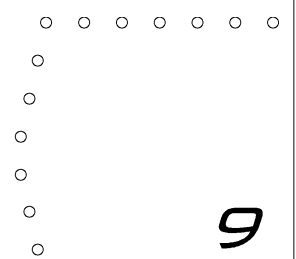

11 in
LETTER
8,5 in

A4

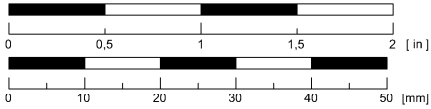

Oldschool backpack

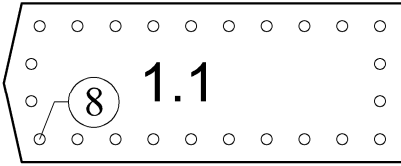

www.CREATIVEAWL.COM

p17

1.9/4

p18

p9

17

1/4

p12

www.CREATIVEAWL.COM

p11

10

11 in
LETTER
8,5 in

A4

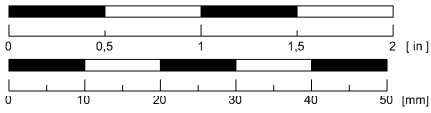

Oldschool backpack



www.CREATIVEAWL.COM

p18

1.9/5

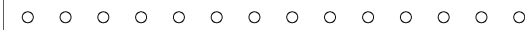

p12

1/5



www.CREATIVEAWL.COM

Striped braces

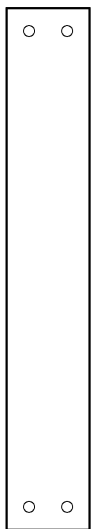
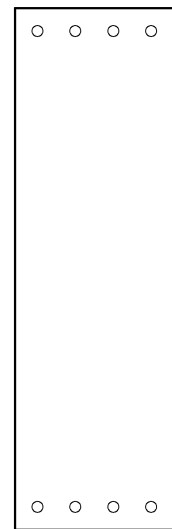

p14

p1

1.8/2

4

p2

4

1/6

2

WWW.CREATIVEAWL.COM

p4

11

11

1.10/1

13

p19

29

29

8.1/1

p23

WWW.CREATIVEAWL.COM

30

30

9.1/1

p26

11 in
LETTER
8,5 in

A4

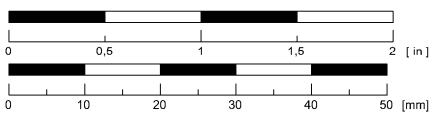

Oldschool backpack

p5



p4

p7



p19

1.10/2

p20

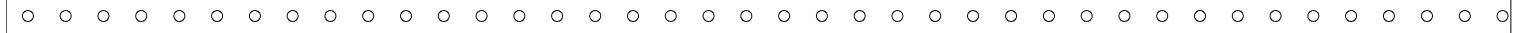

p23

8.1/2

p24



p26

9.1/2

p27

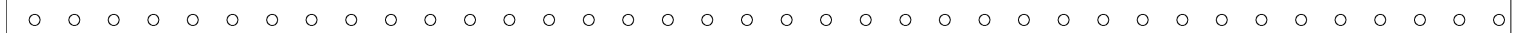

11 in
LETTER
8,5 in

A4

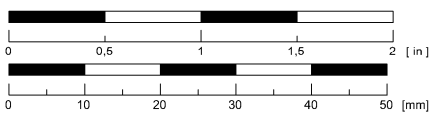

Oldschool backpack

1 3

p8

9



p7

p10

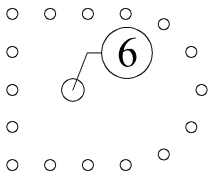

p20

p21

1.10/3

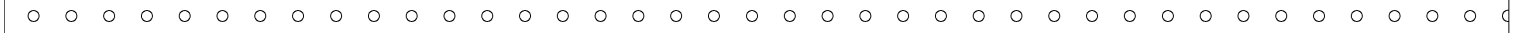

p24

p25

8.1/3



p27

p28

9.1/3



11 in
LETTER
8,5 in

A4

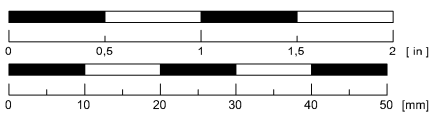

Oldschool backpack

14

p11

1/9

p13

p10

18

WWW.CREATIVEAWL.COM

p21

1.10/4

p22

p25

8.1/4

31

8.2/1

31

p29

WWW.CREATIVEAWL.COM

p28

9.1/4

32

9.2/1

32

p30

11 in
LETTER
8,5 in

A4

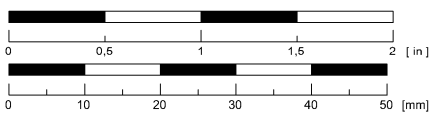

Oldschool backpack

15

p14

p13

1/10

www.CREATIVEAWL.COM

Striped braces

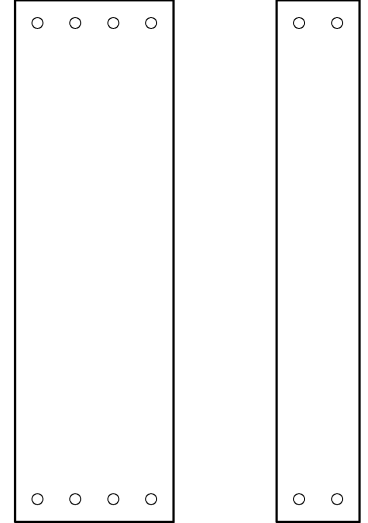

p22

1.10/5

p29

33

8.2/2

33

www.CREATIVEAWL.COM

p30

34

9.2/2

34

11 in
LETTER
8,5 in

A4

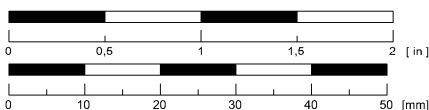

Oldschool backpack

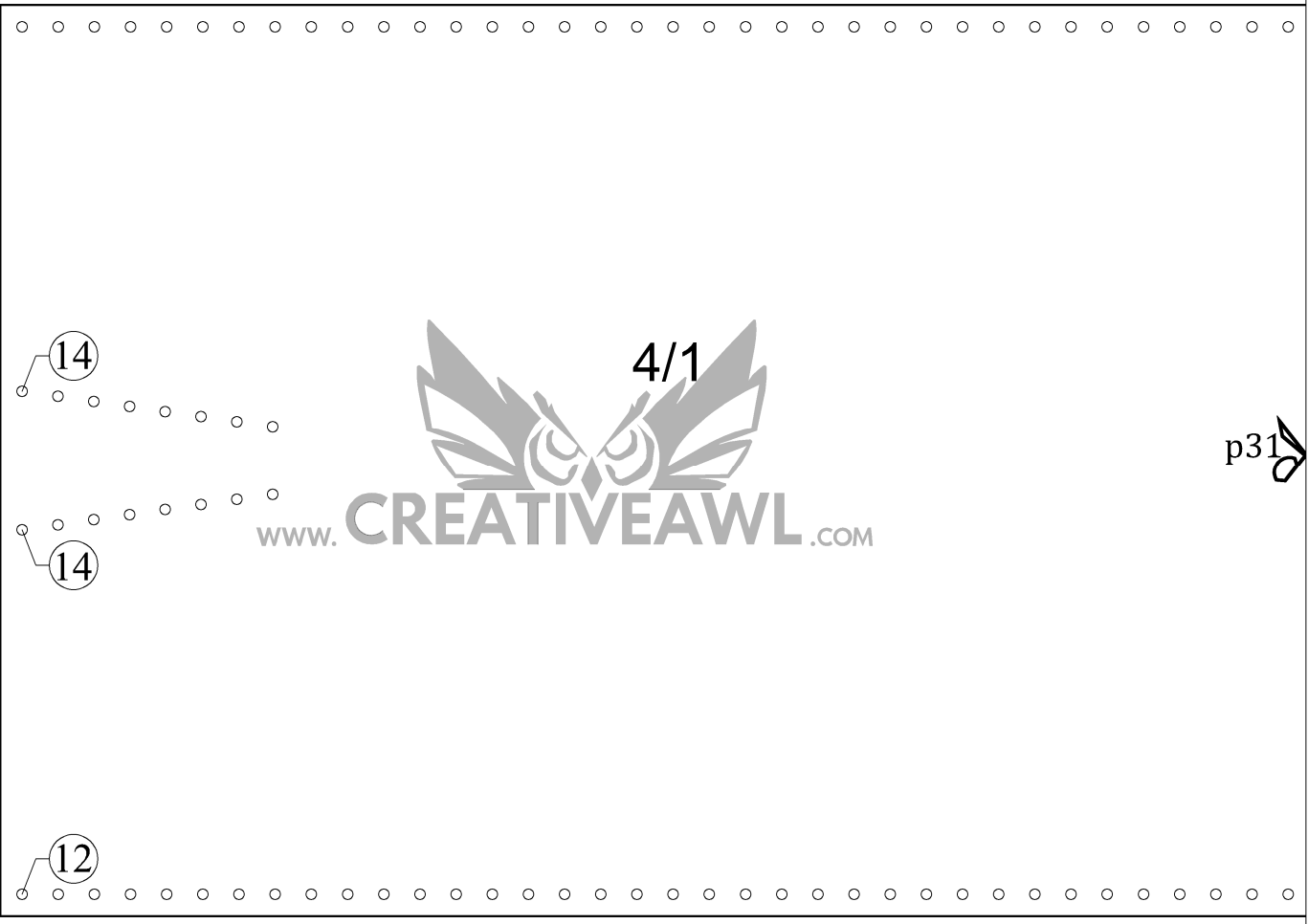

WWW.CREATIVEAWL.COM

p31 

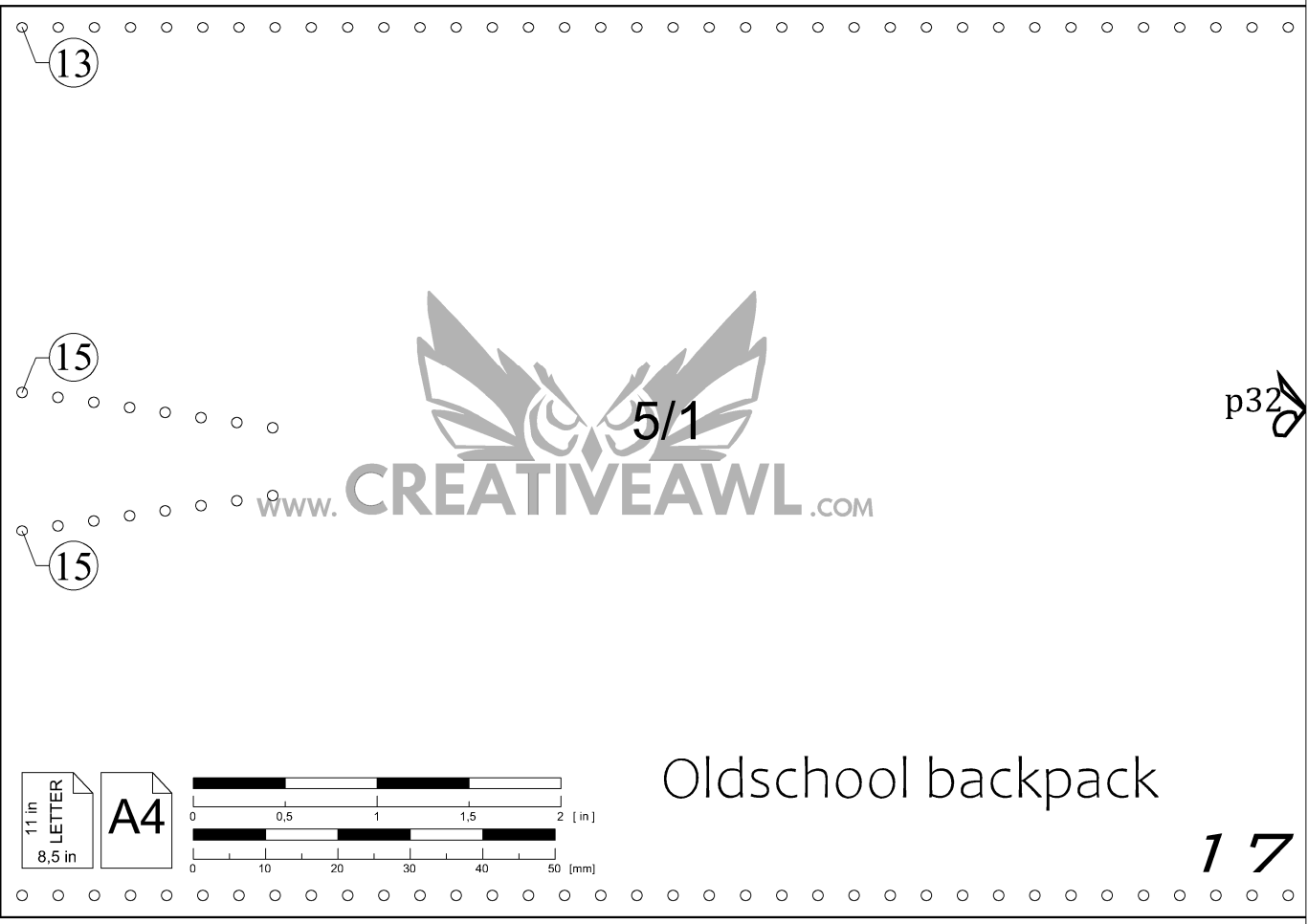

WWW.CREATIVEAWL.COM

p32 

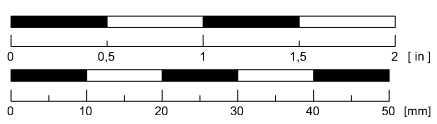
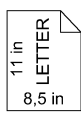

Oldschool backpack

17

p31

4/2



WWW.CREATIVEAWL.COM

p32

5/2



WWW.CREATIVEAWL.COM

Oldschool backpack

11 in
LETTER
8,5 in

A4

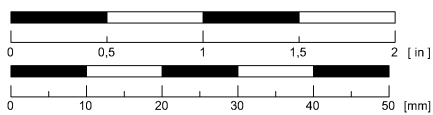

11 in
LETTER
8.5 in

A4

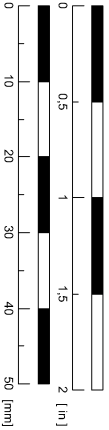

Oldschool backpack

3.1

16

p33

3/1

19

20

16

p34

3.2

16

p35

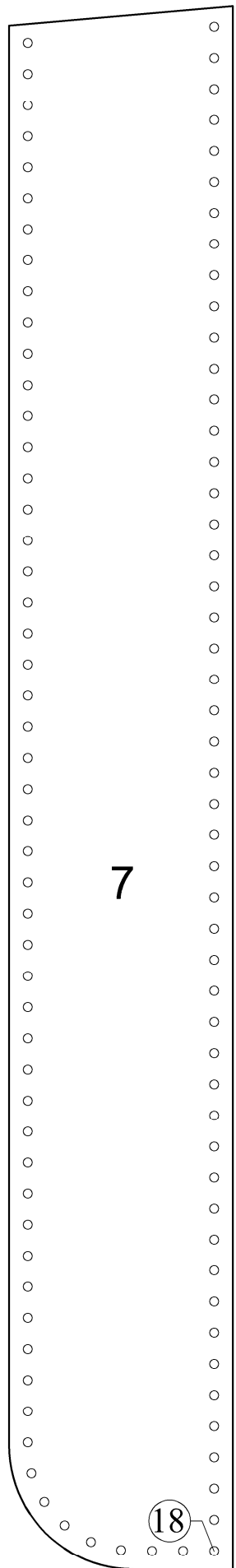
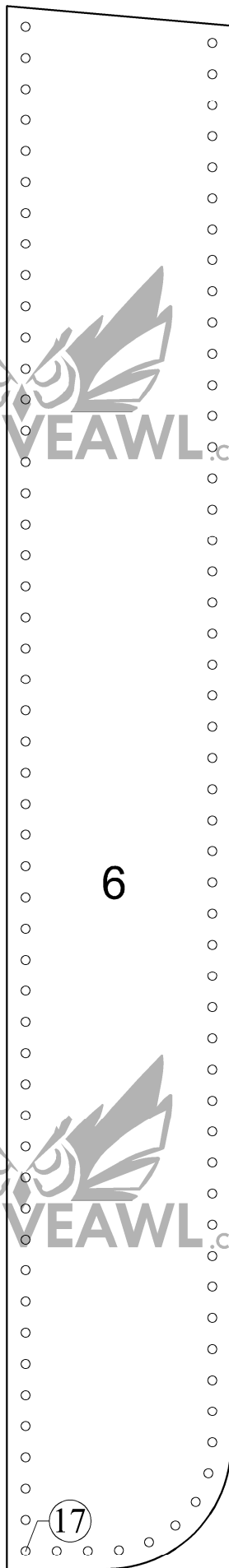
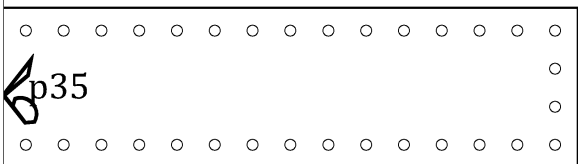
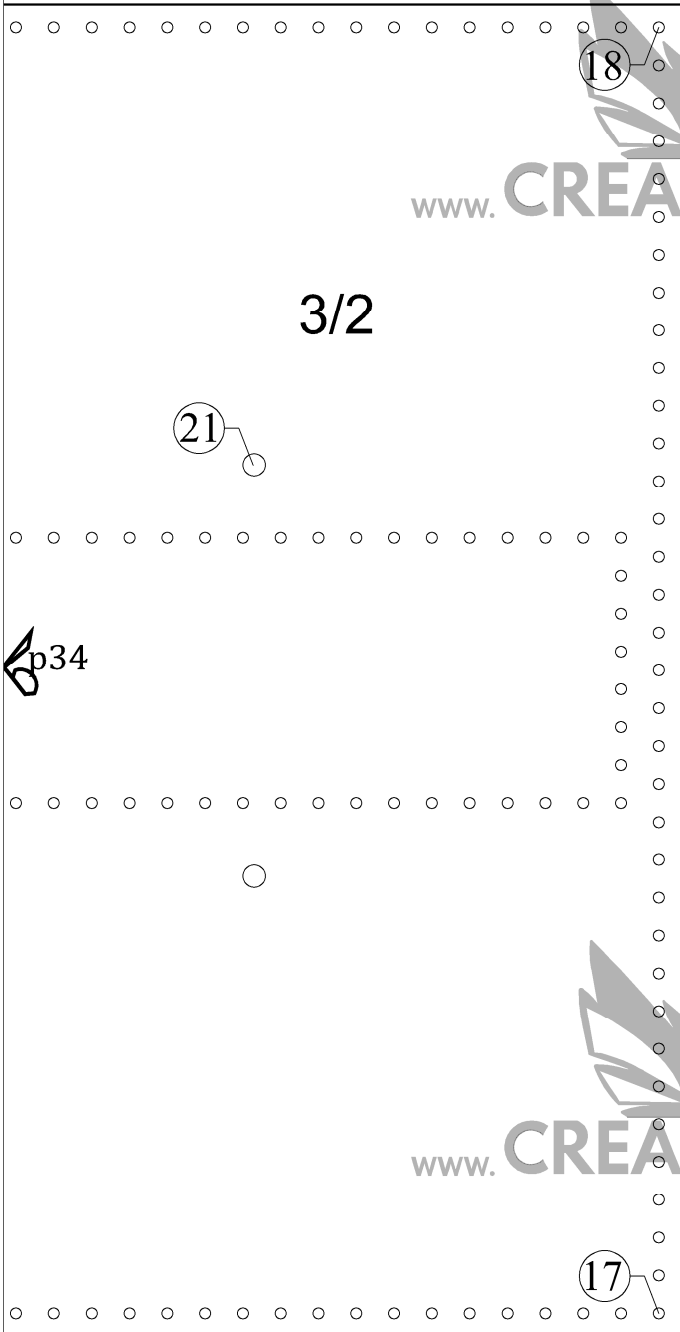
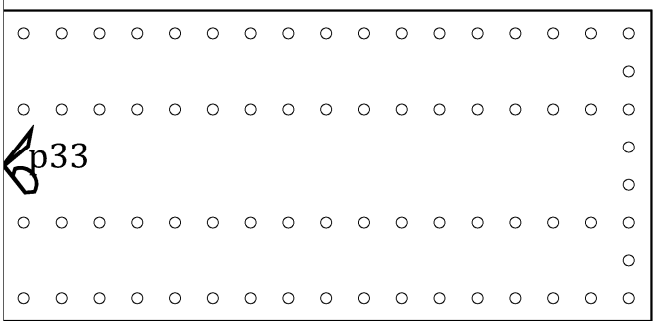

11 in
8.5 in
LETTER

A4

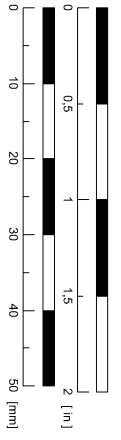

www.CREATIVEAWL.COM

www.CREATIVEAWL.COM

Oldschool backpack

11 in
LETTER
8,5 in

A4

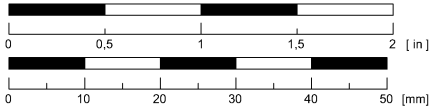

Oldschool backpack

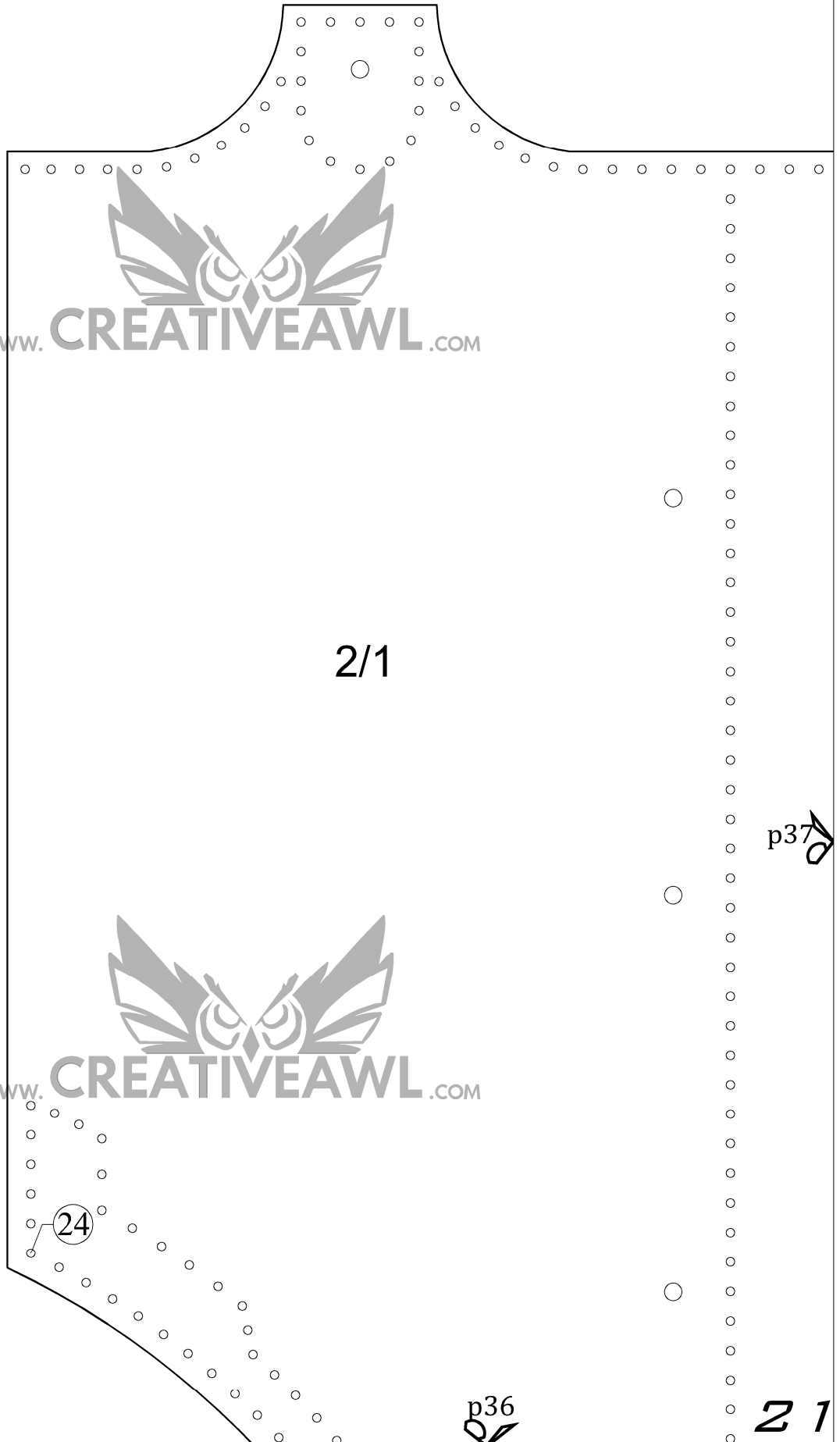
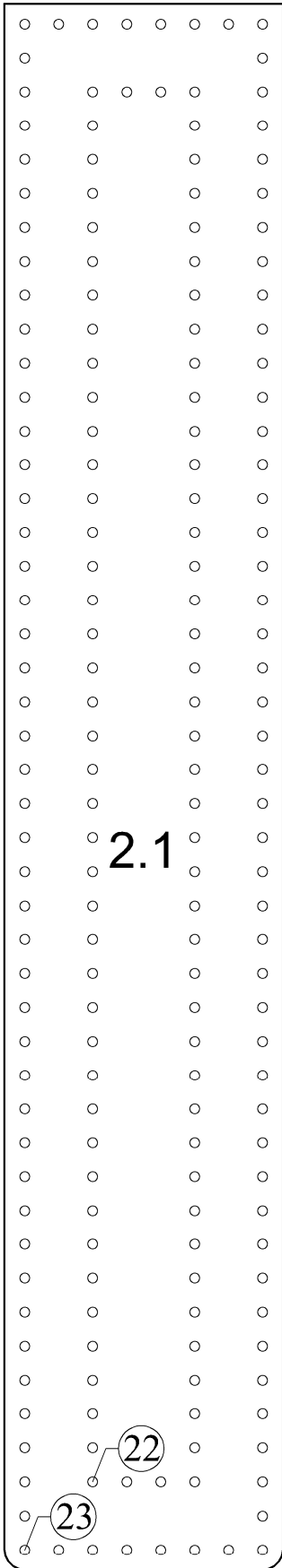

11 in
LETTER
8,5 in

A4

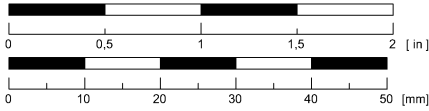

Oldschool backpack

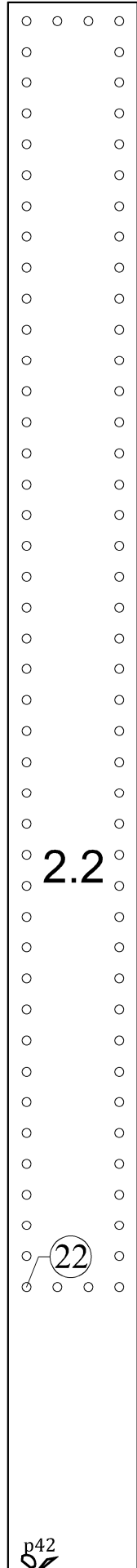
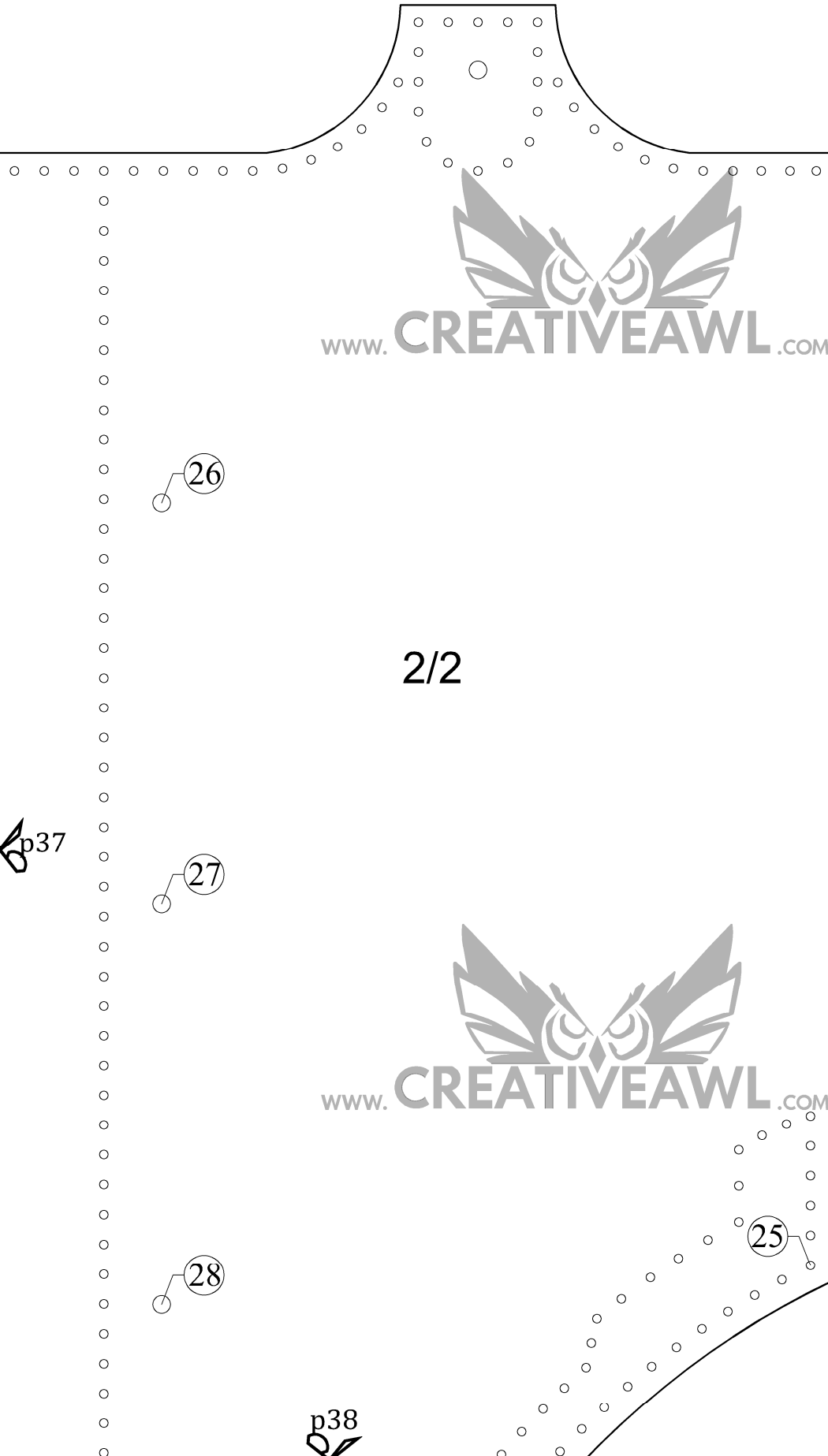

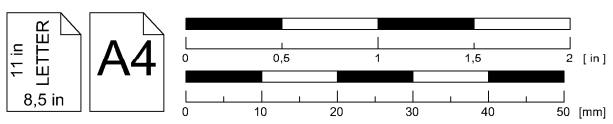
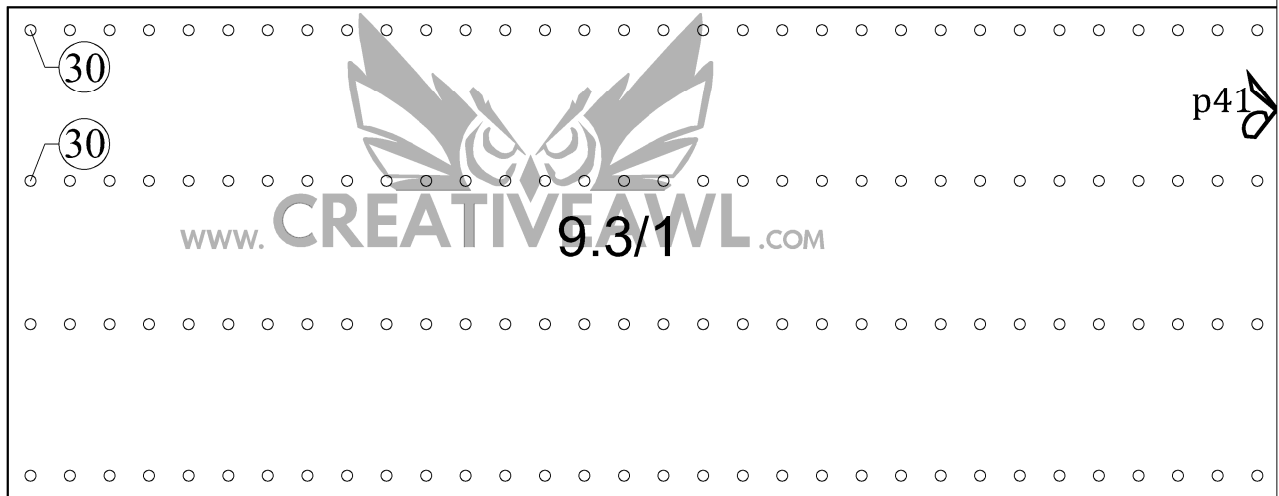
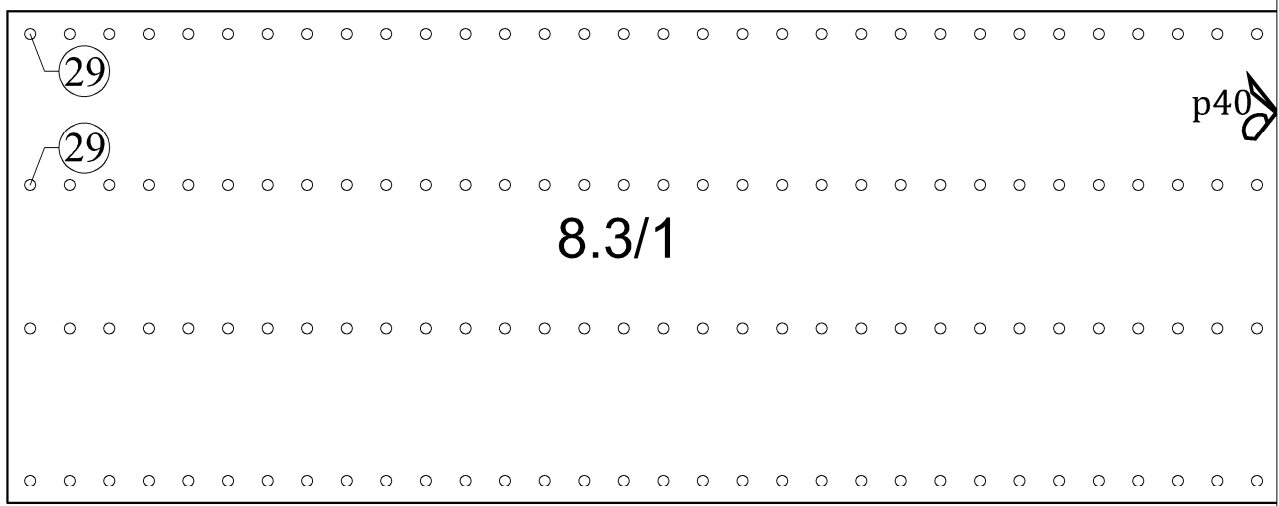
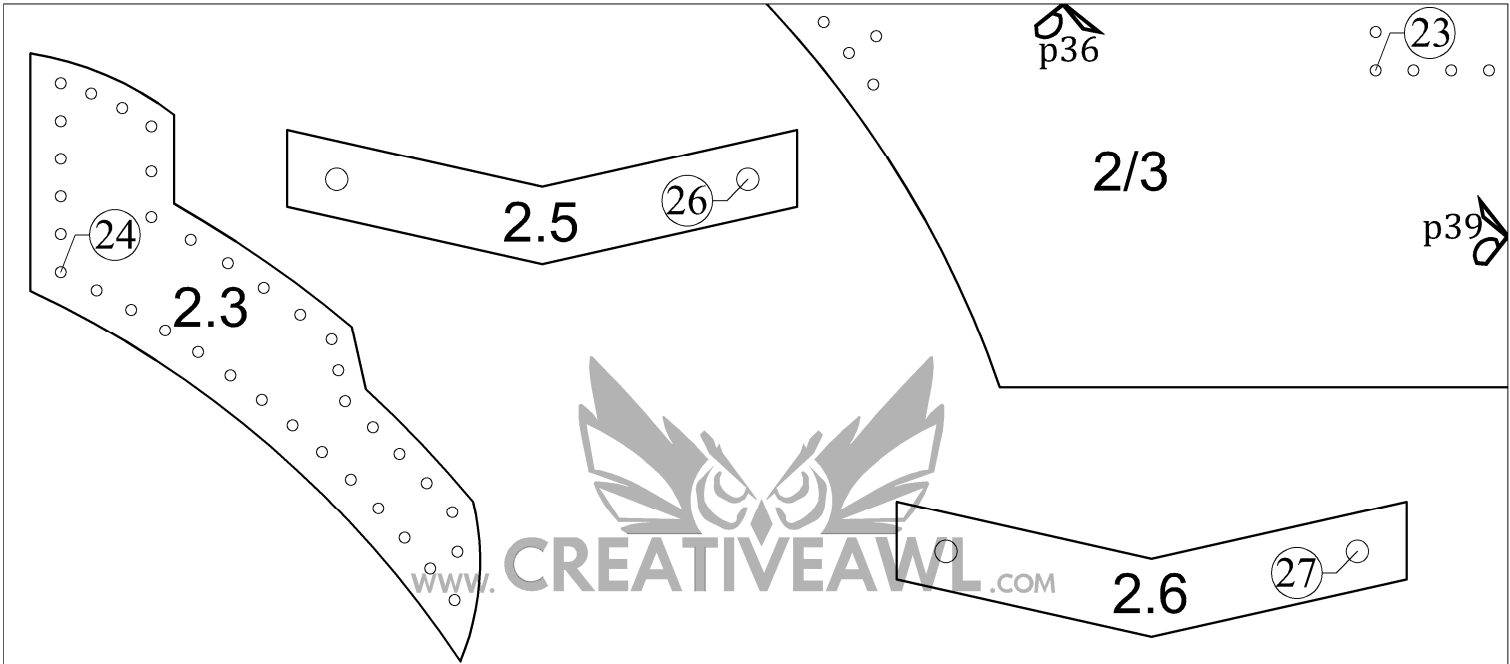

Oldschool backpack

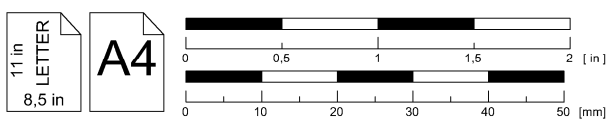
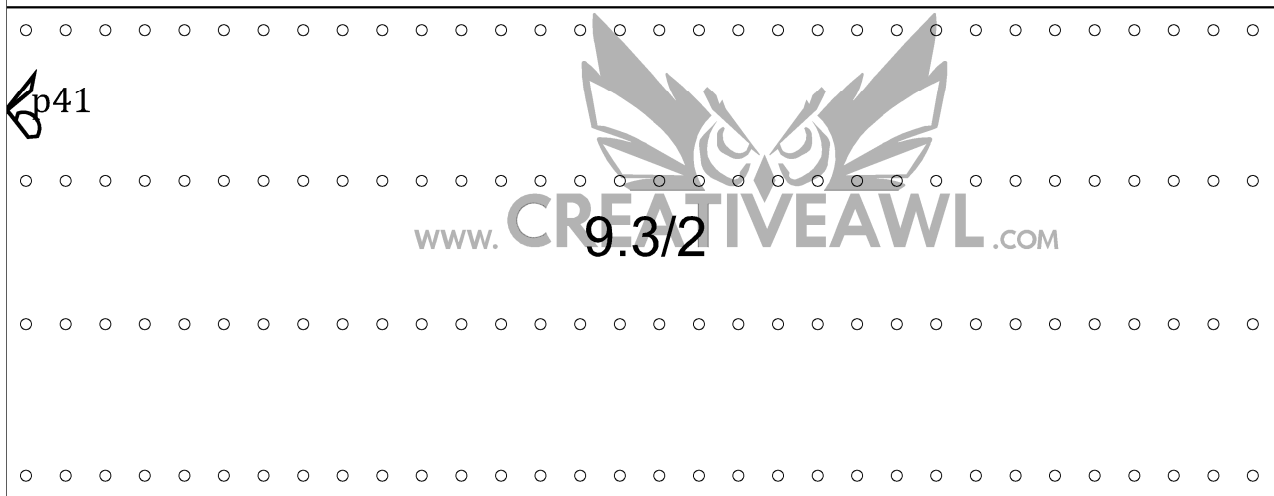
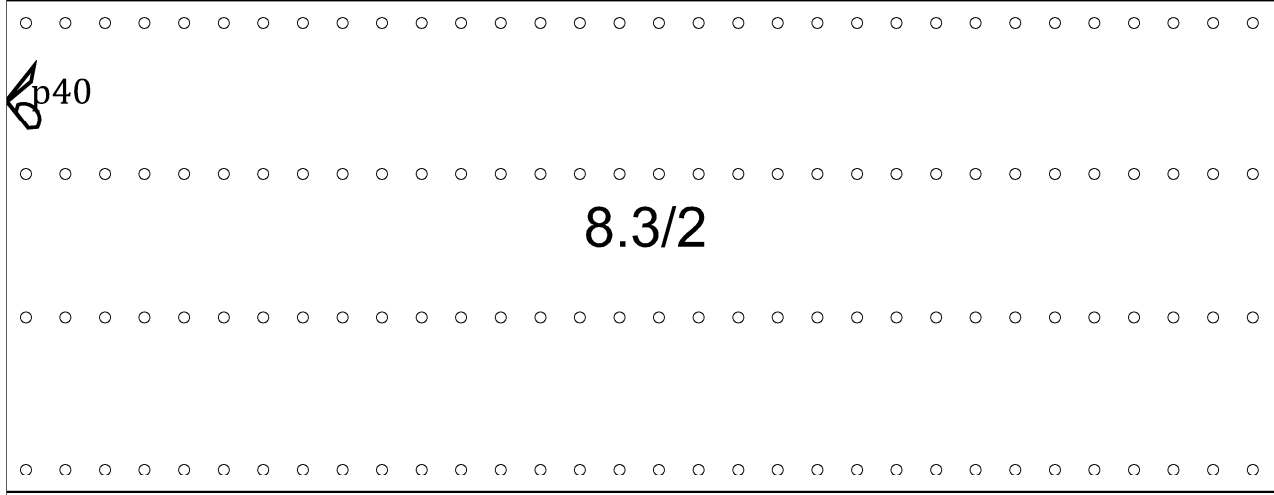
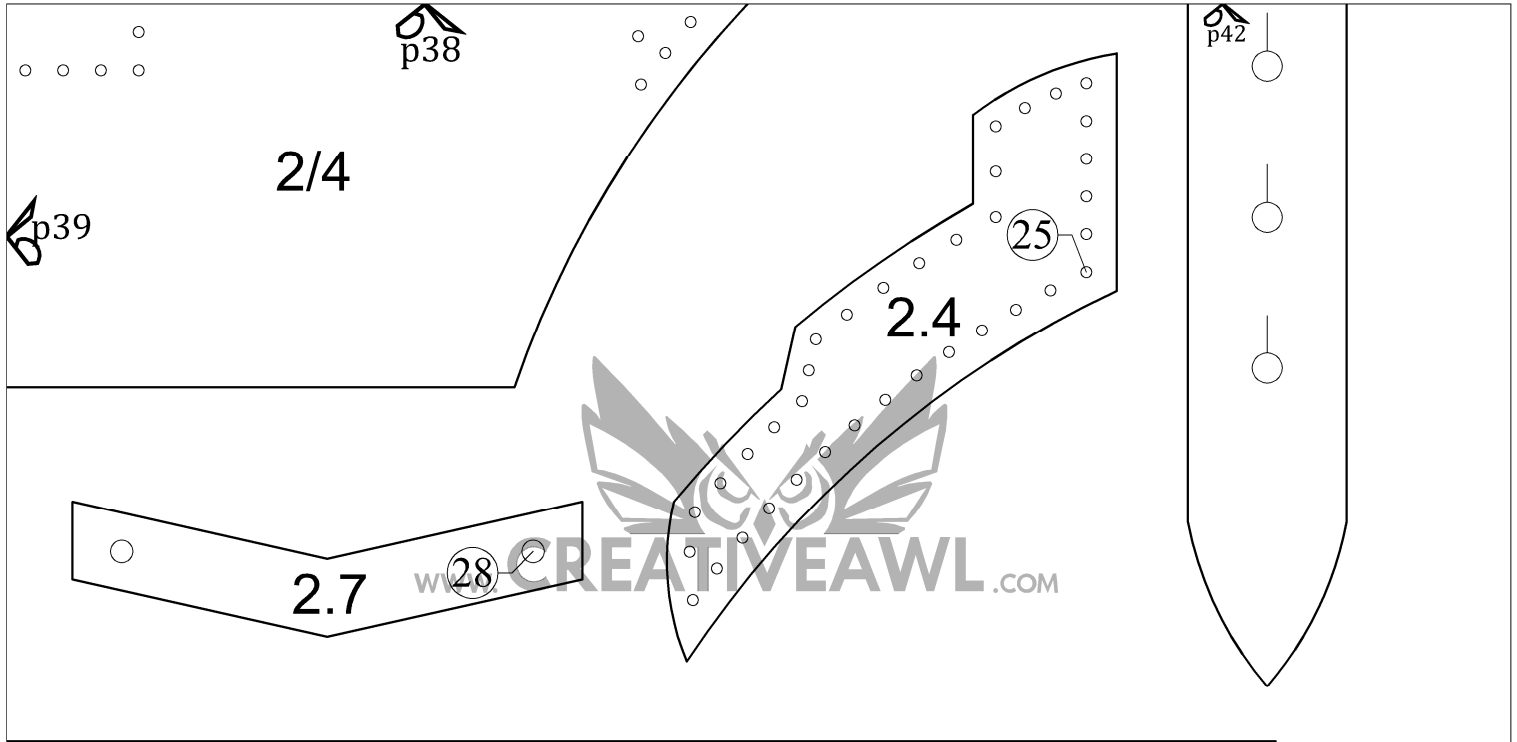

Oldschool backpack