

Заказать выкройку по эскизу или фото
готовые выкройки рюкзаков, сумок, портфелей и т. д.

https://vk.com/mark_nikolai_leather

https://boosty.to/mark_nikolai

а 1.1

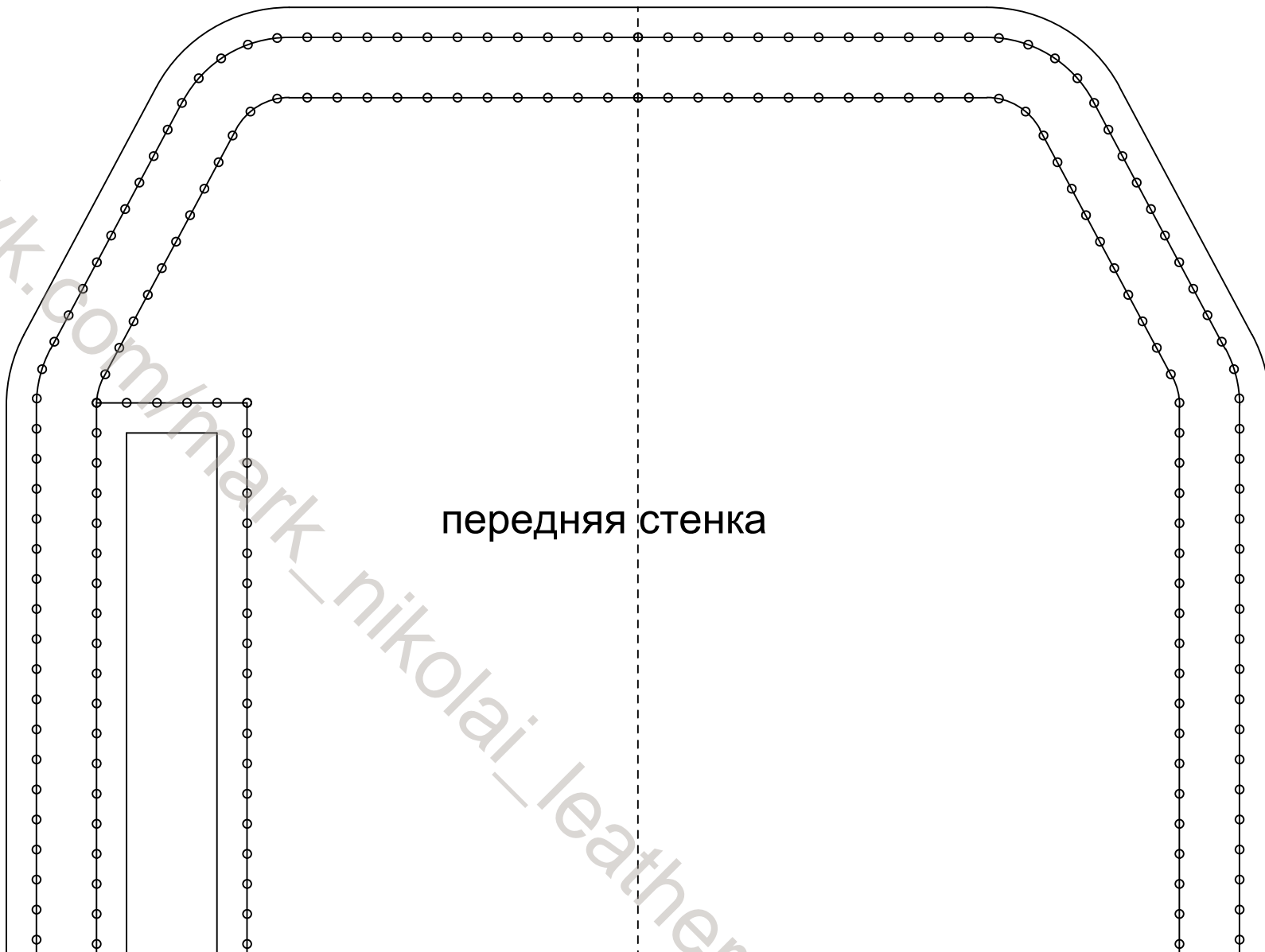

передняя стенка

a 2.1

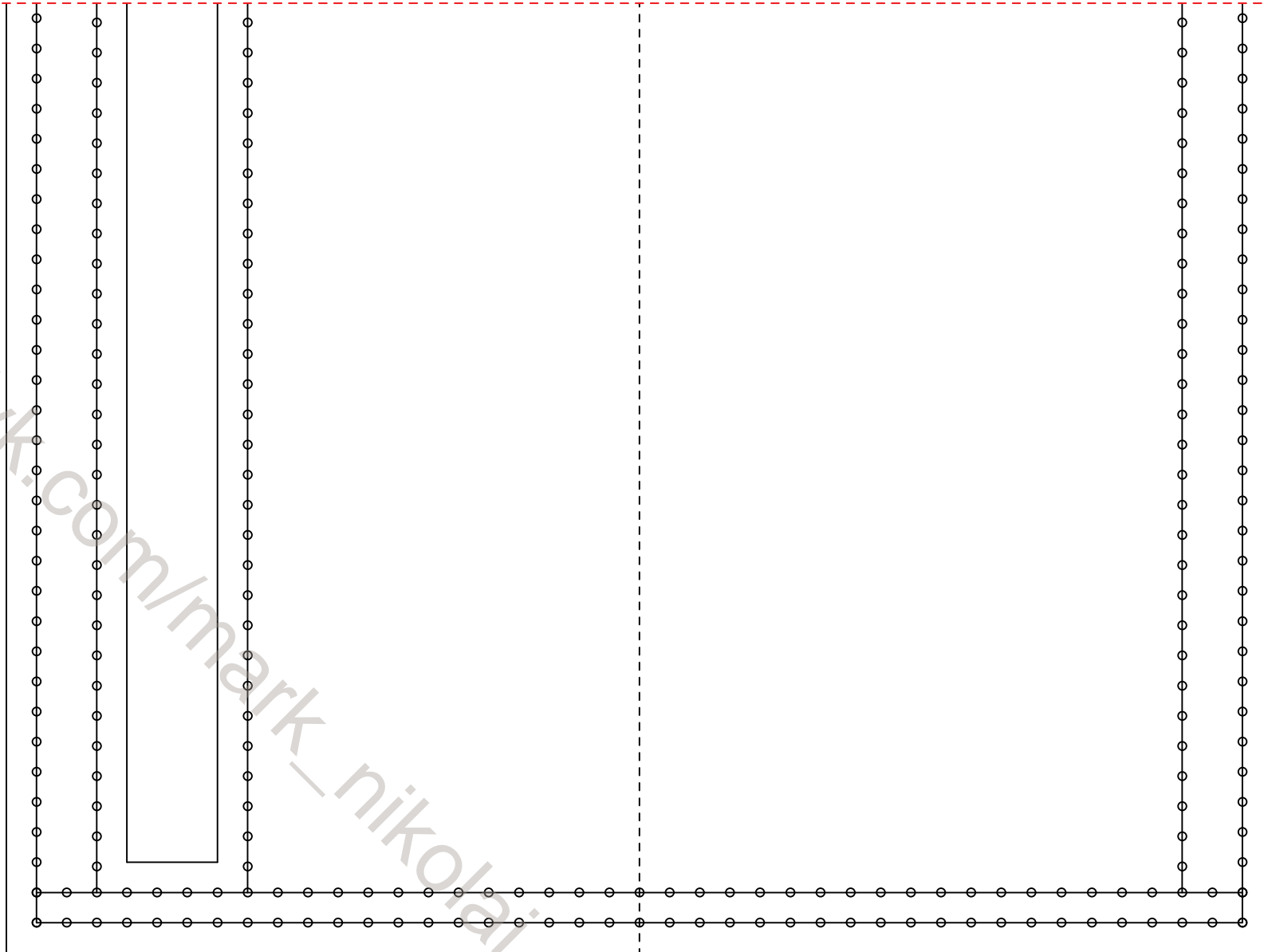

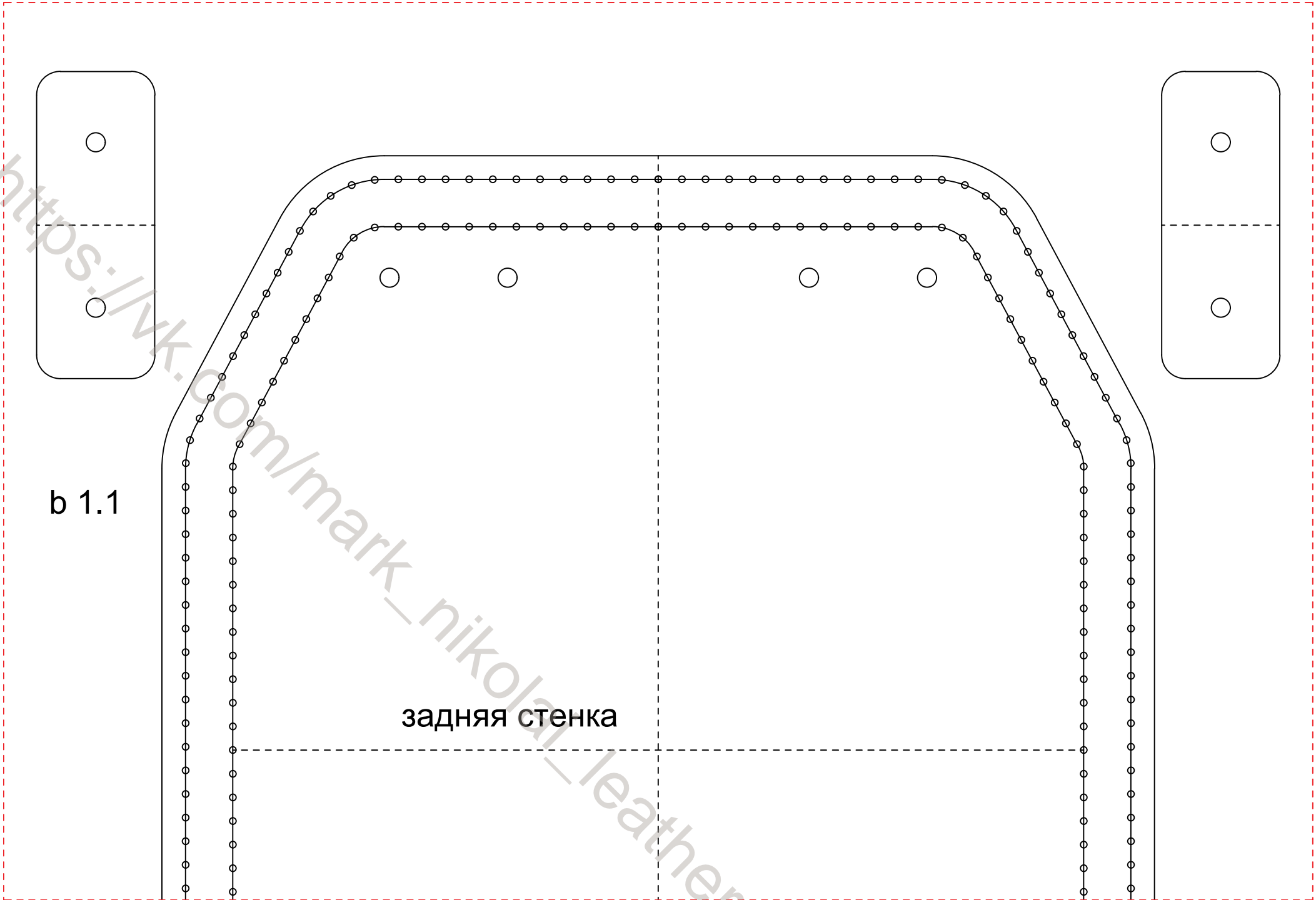

b 1.1

задняя стенка

b 2.1

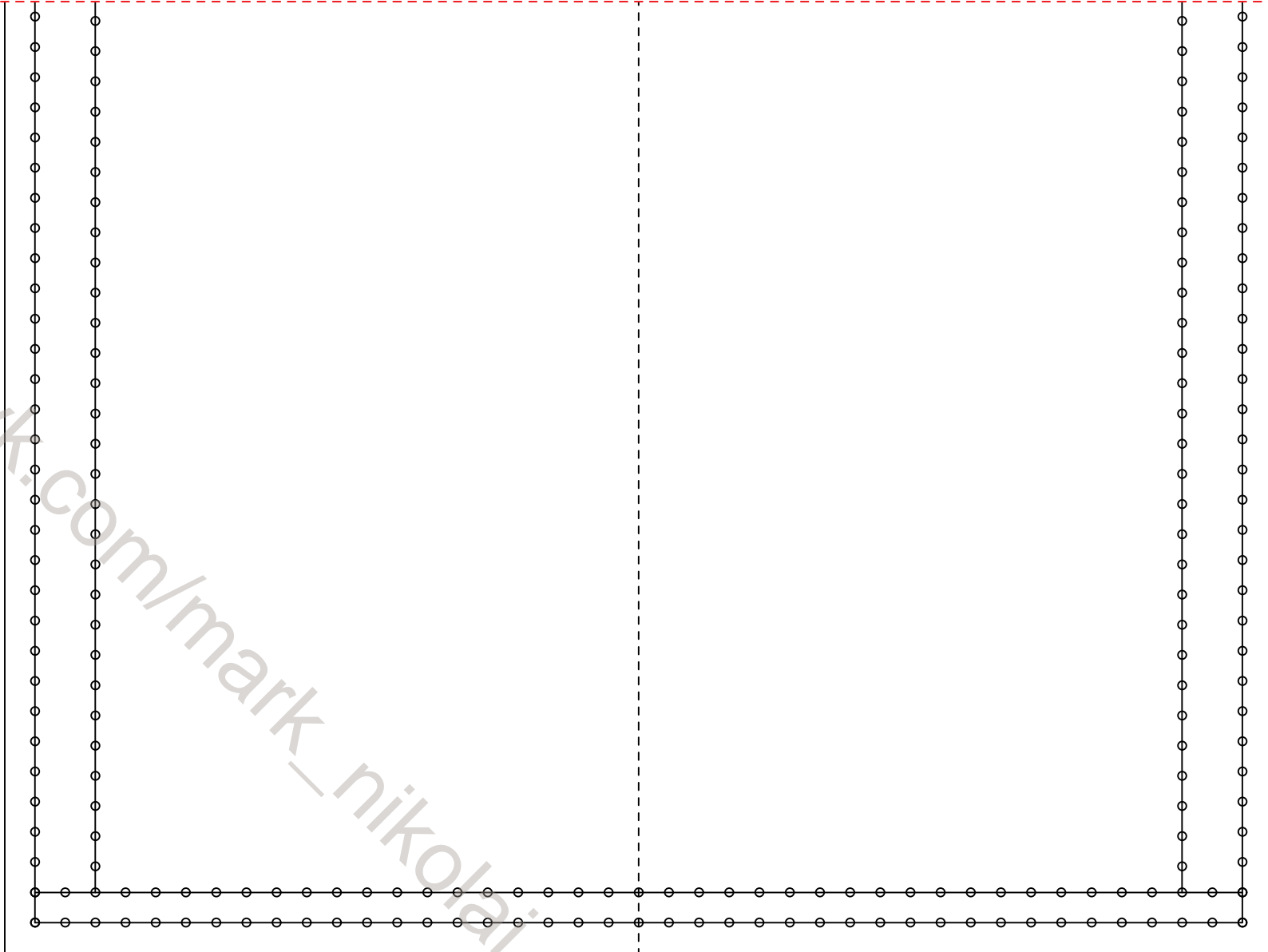

https://vk.com/mark_nikolai_leather

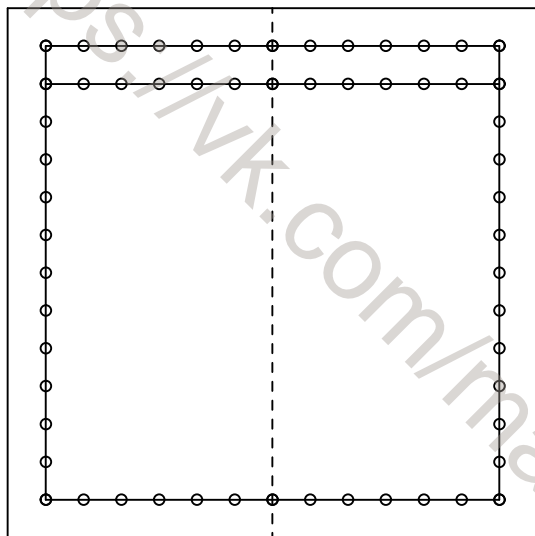
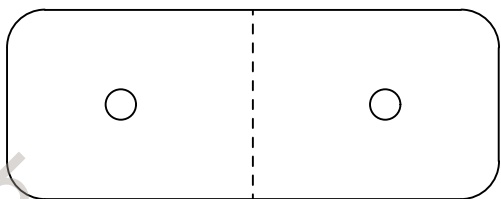

с 1.1

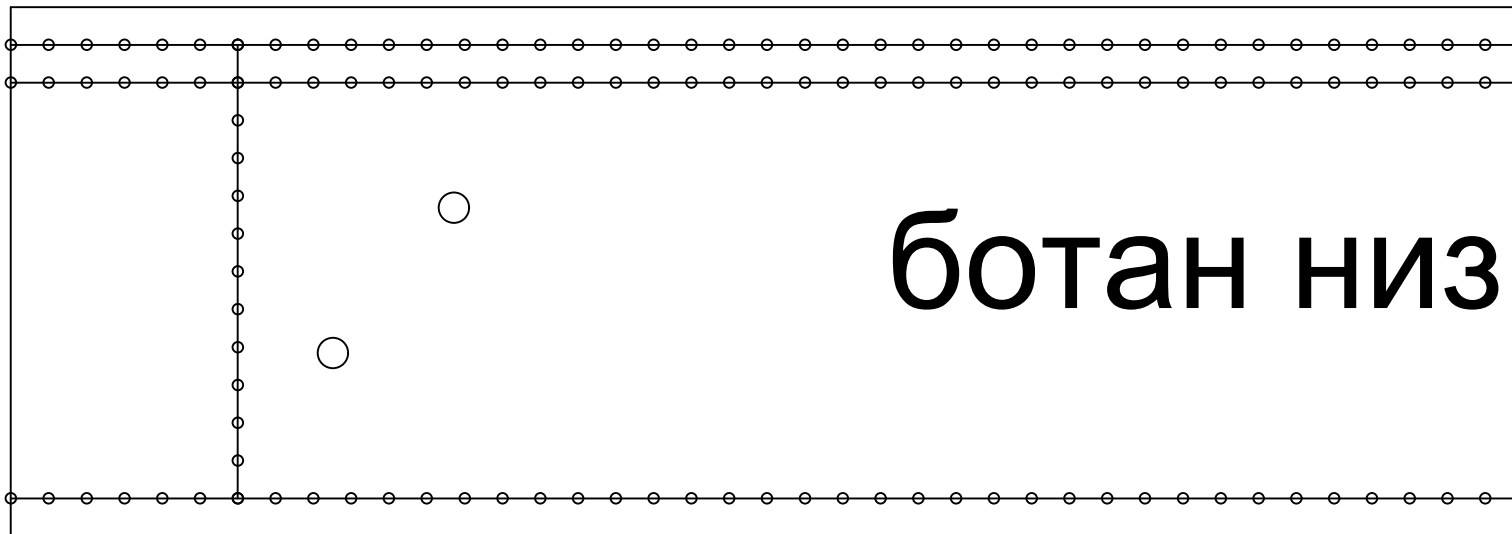

ботан низ



ботан низ-2

https://vk.com/mark_nikolai_leather

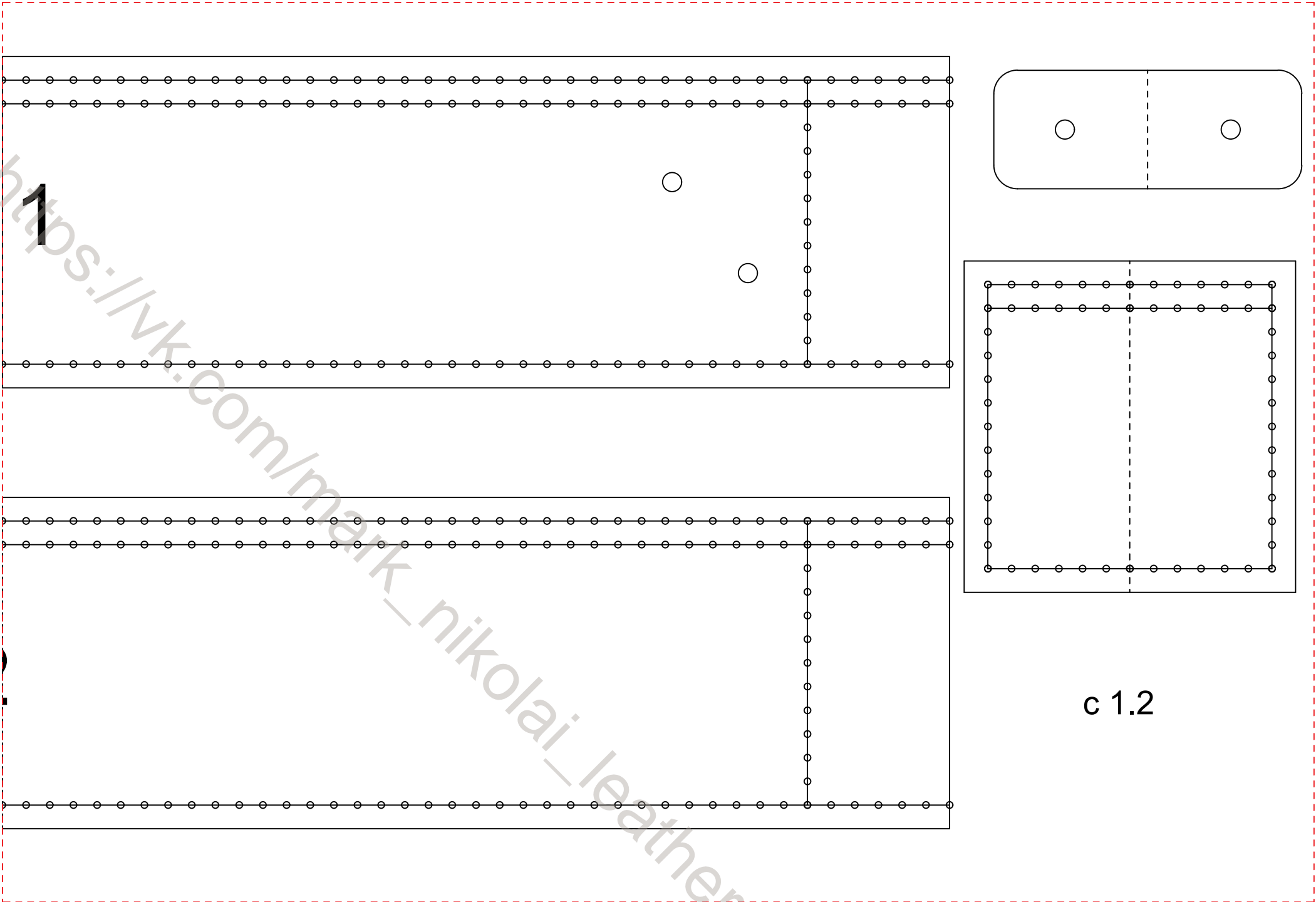

c 1.2

d 1.1

ДОНЫШ

https://vk.com/mark_nikolai_leather

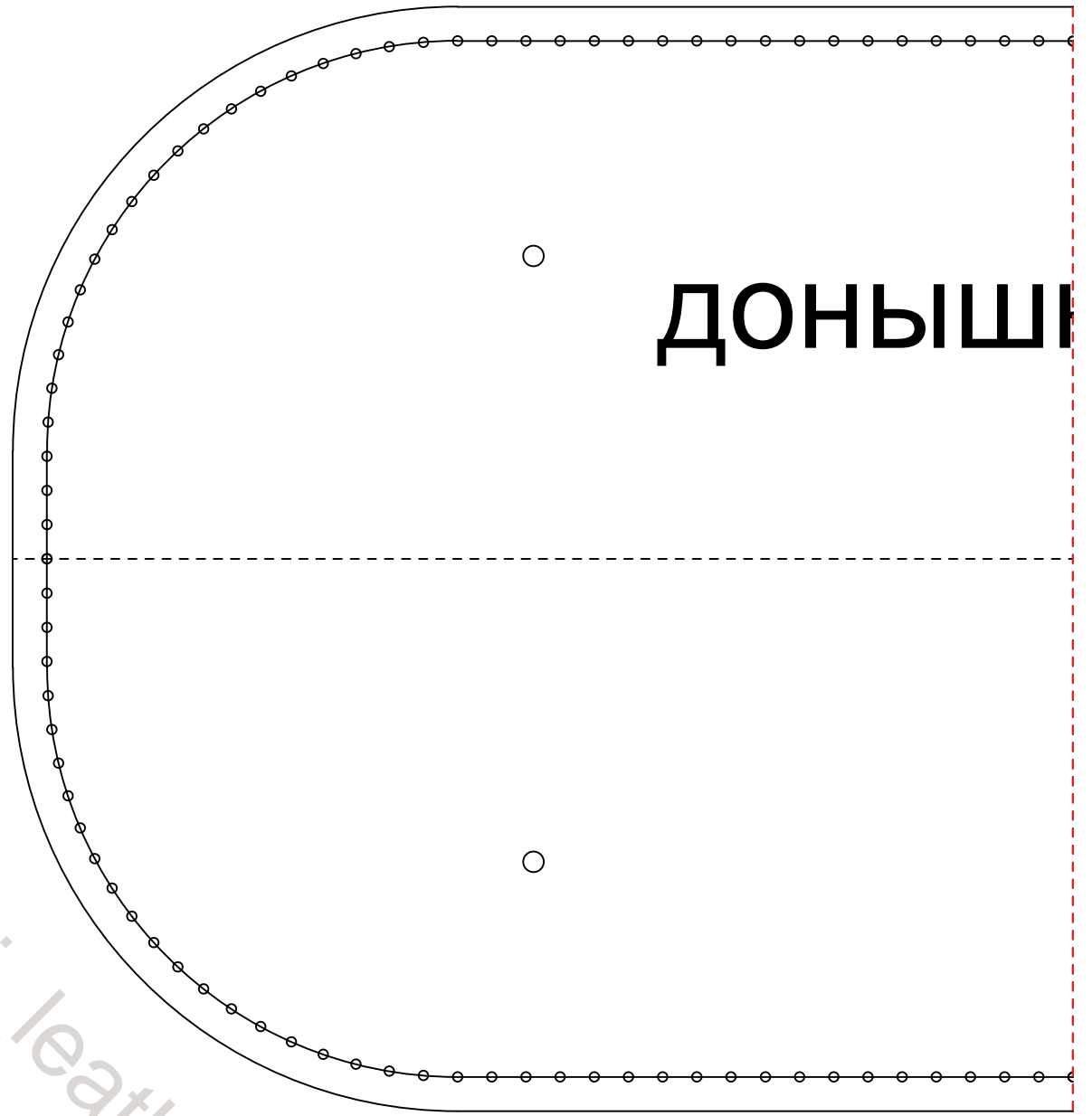

d 1.2

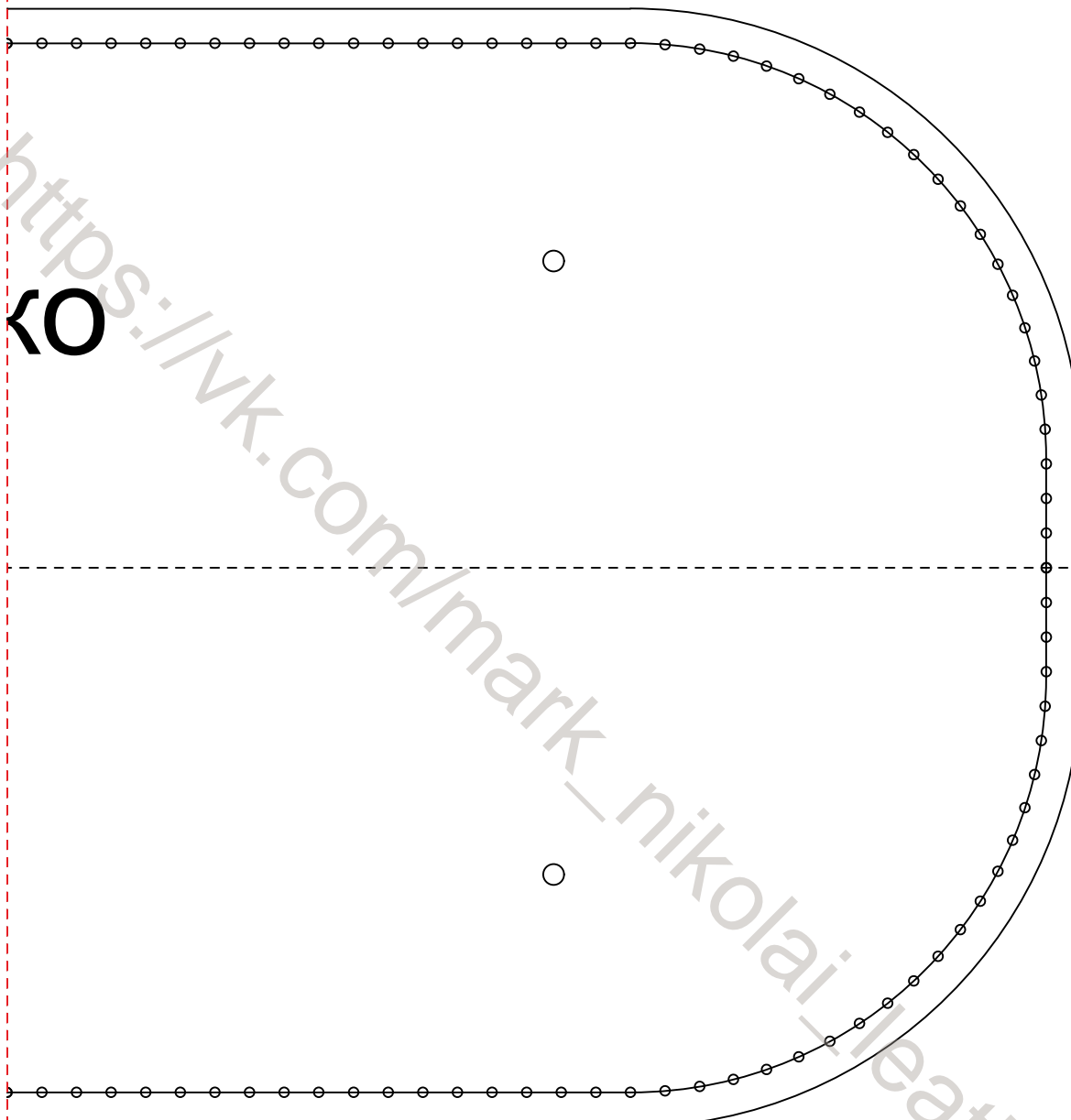

KO

https://vk.com/mark_nikolai_leather

e 1.1

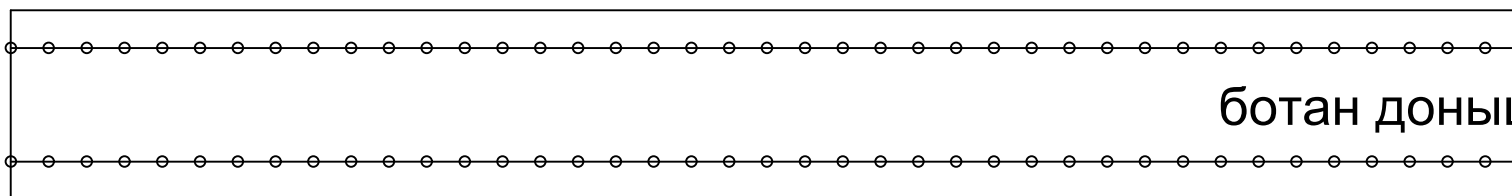
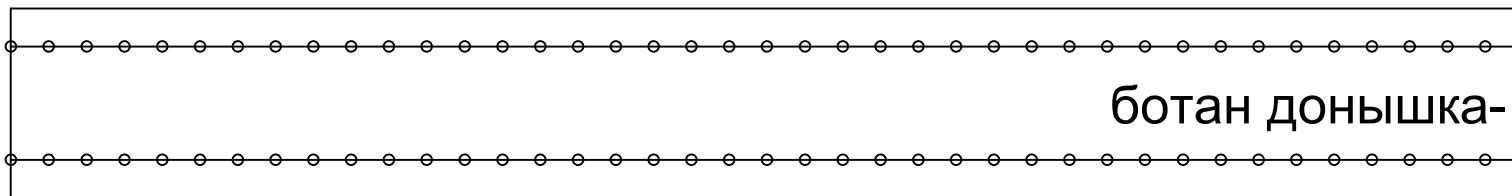

https://vk.com/mark_nikolai_leather

е 1.2

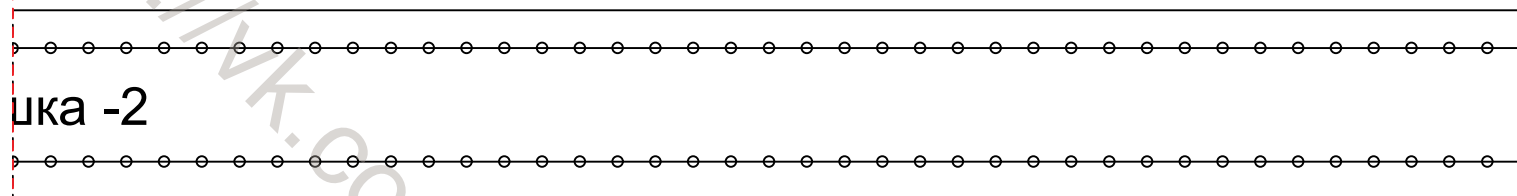
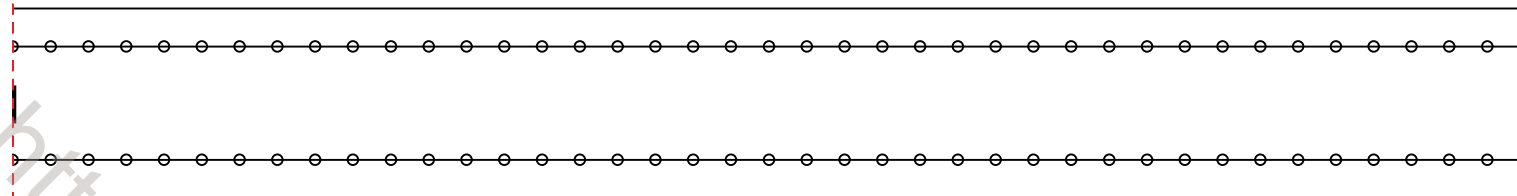

шка -2



ка

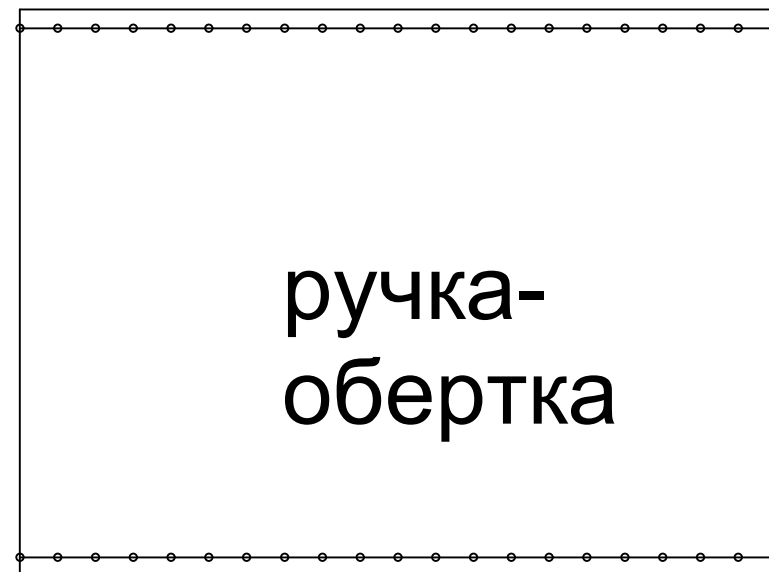

ручка-
обертка

https://vk.com/mark_nikolai_leather

f 1.1

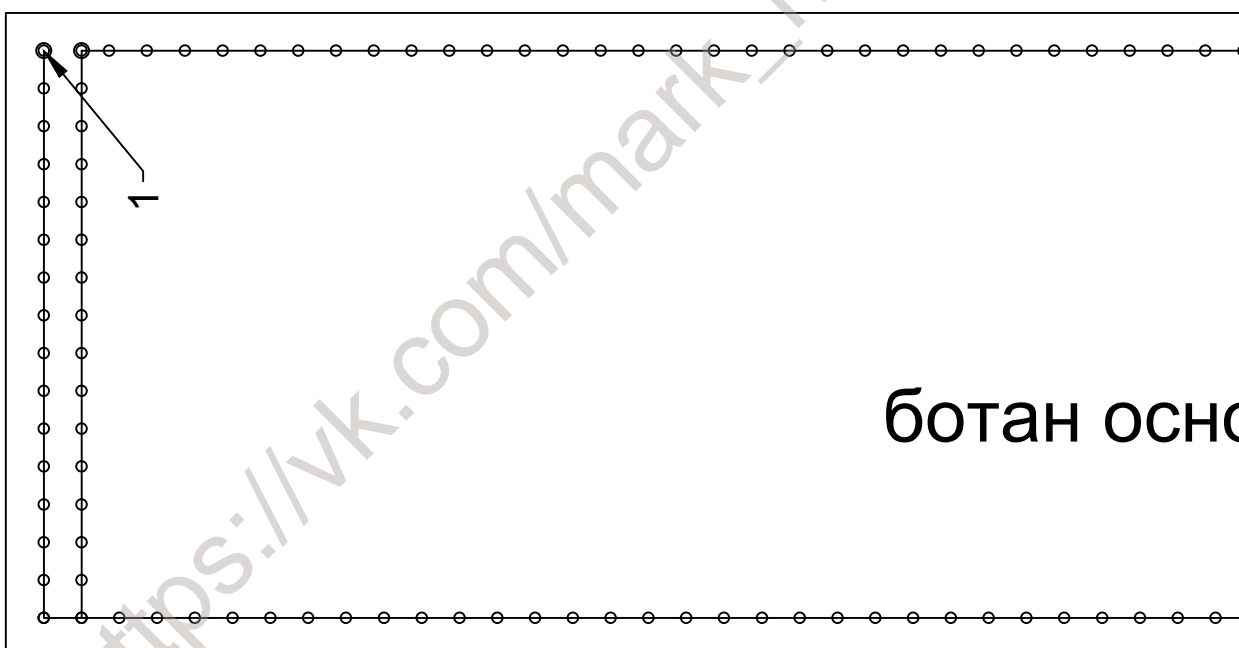
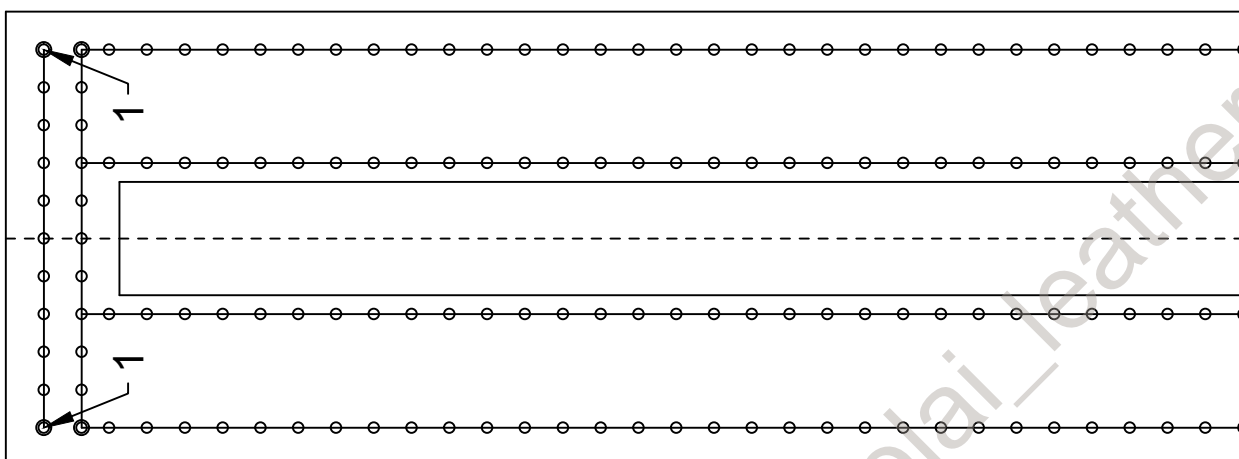
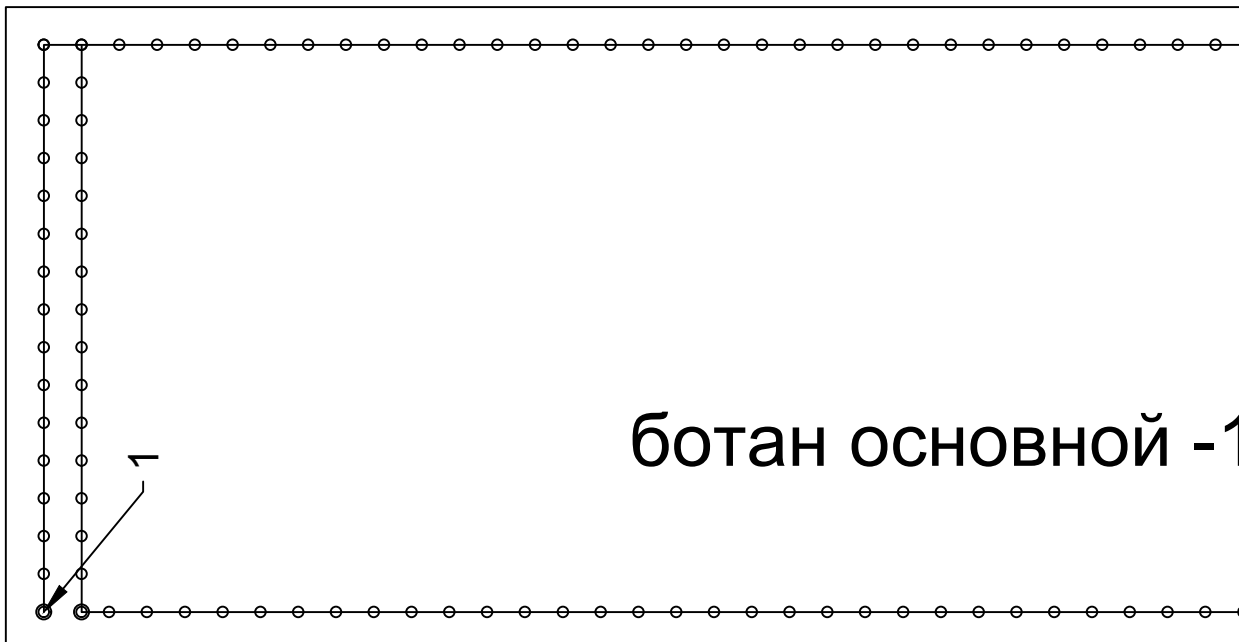

https://vk.com/mark_nikolai_leather

f 1.2

ботан основной-3

ВНОЙ-2

https://vk.com/mark_nikolai_leather

f 1.3

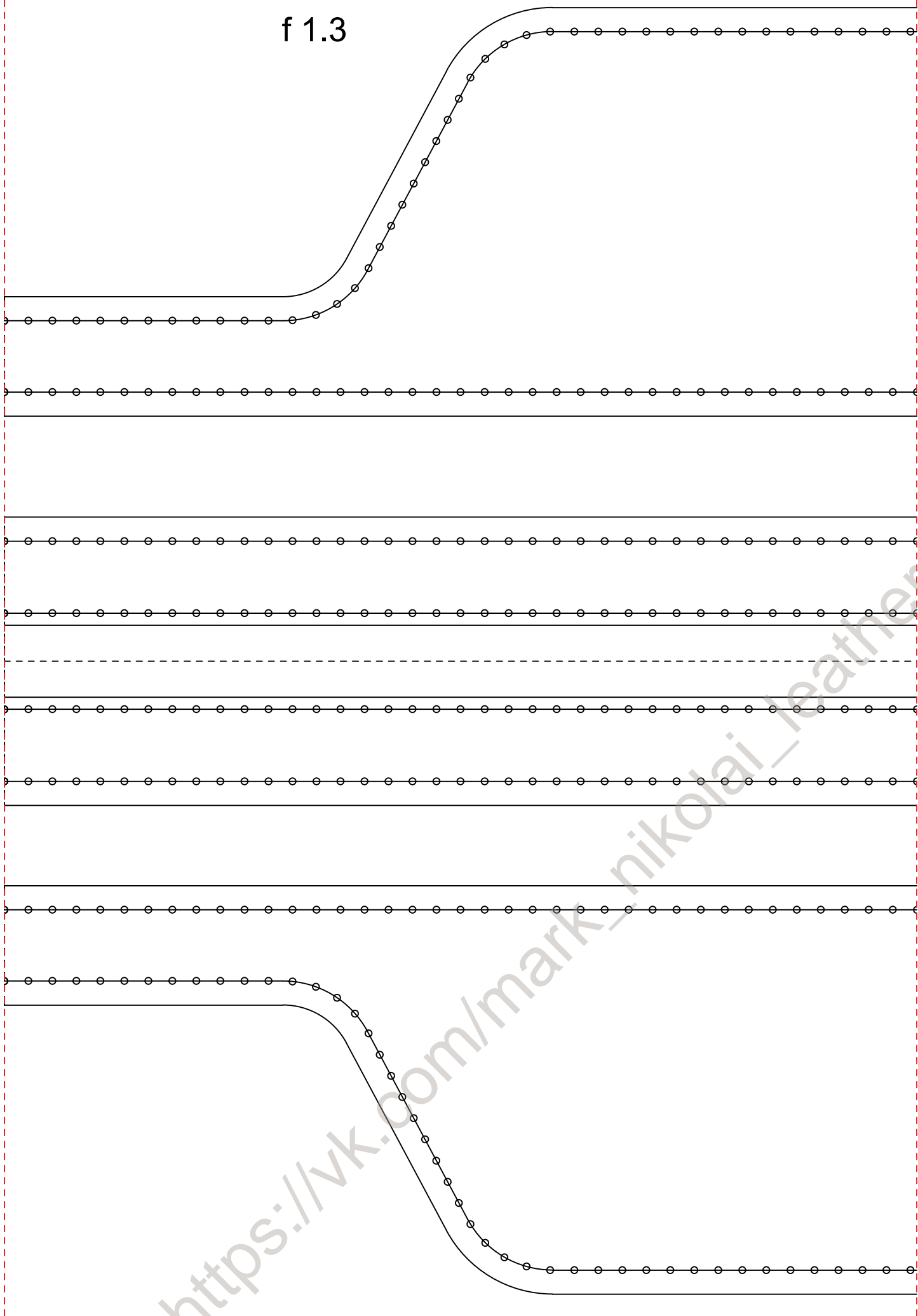

https://vk.com/mark_nikolai_leather

f 1.4

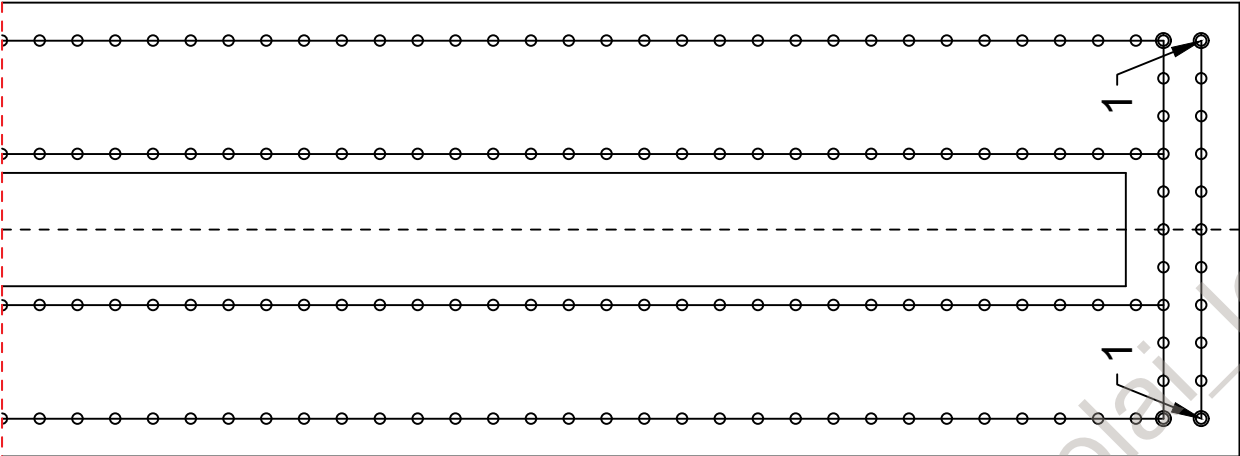
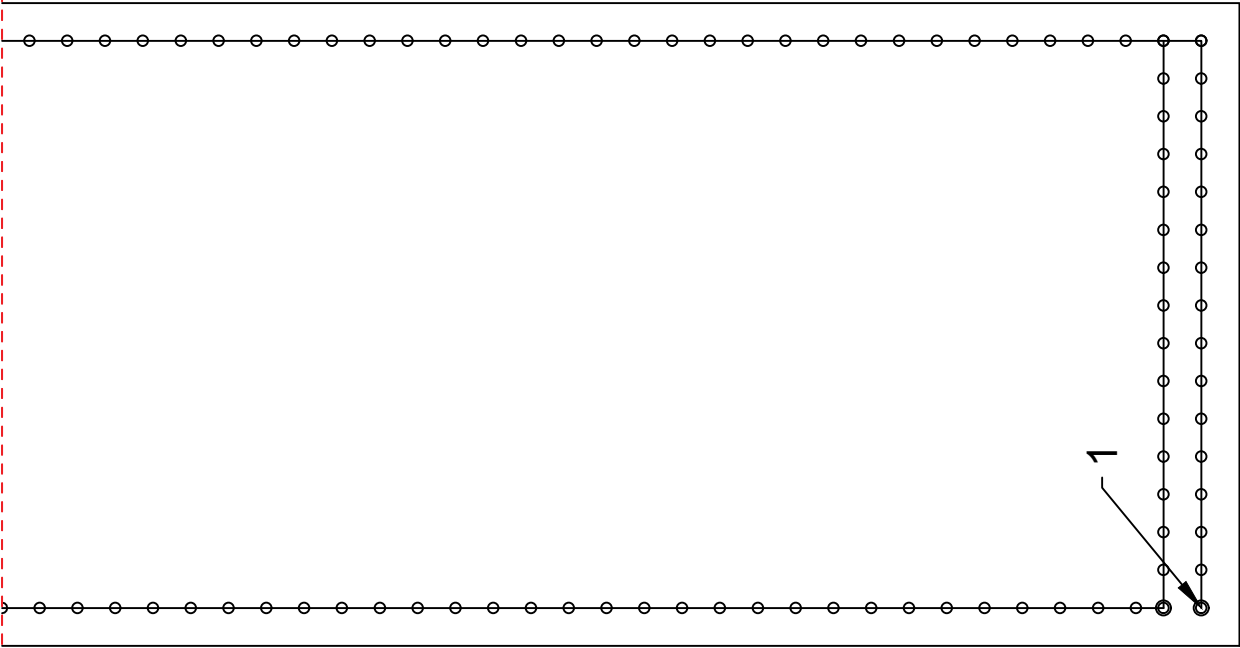

https://vk.com/mark_nikolaj_leather

g 1.1

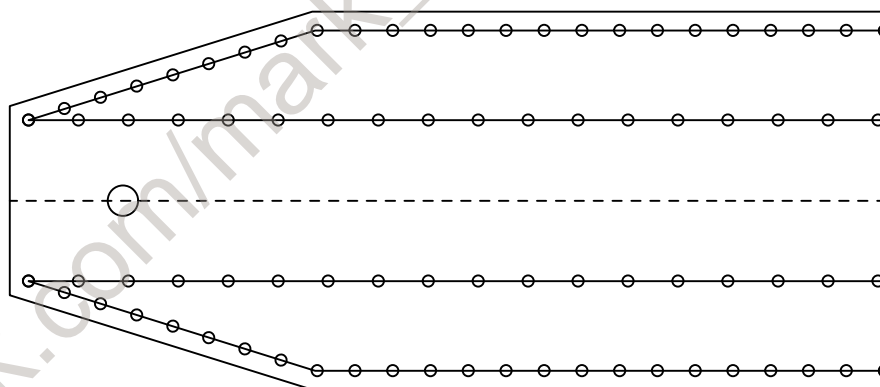
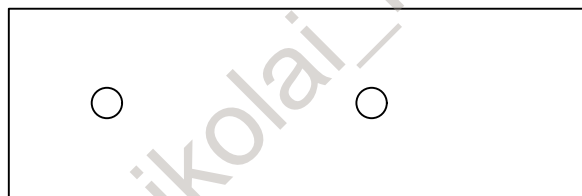
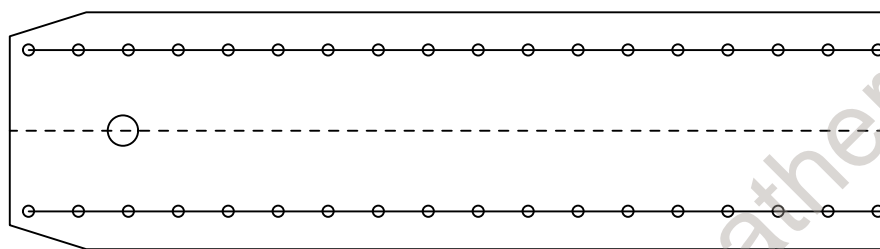
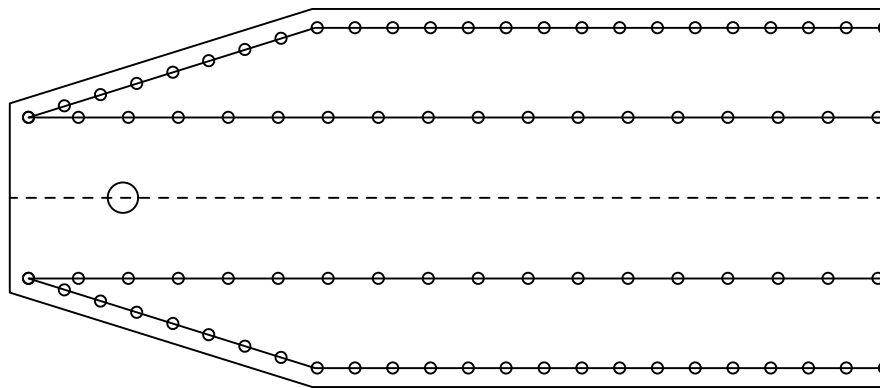
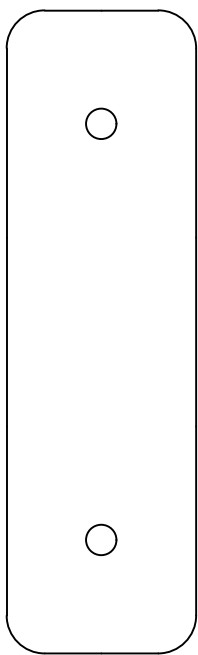

https://vk.com/mark_nikolai_leather

g 1.2

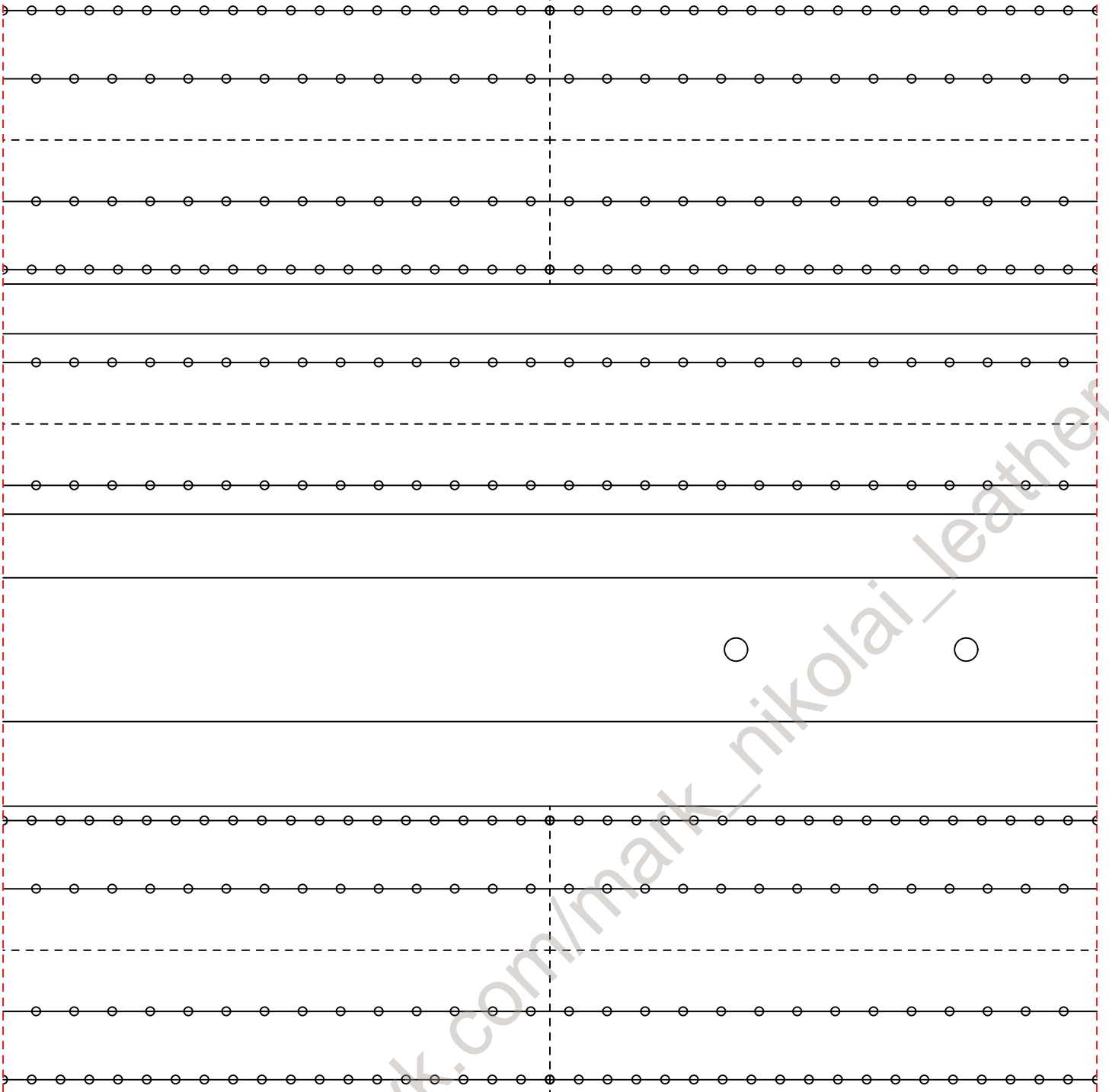

g 1.3

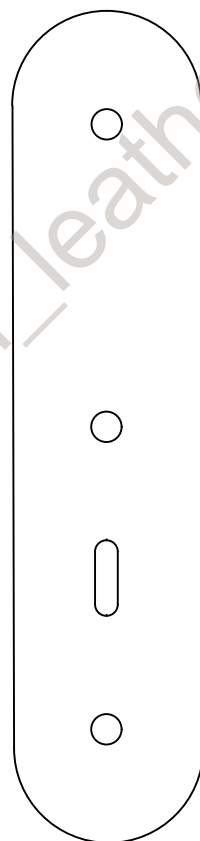
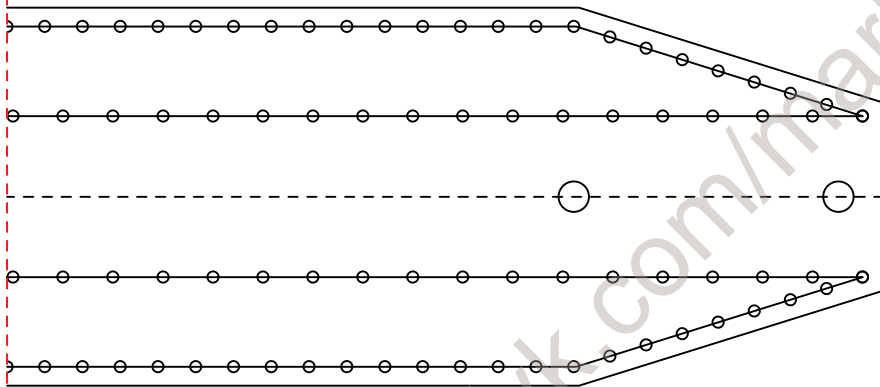
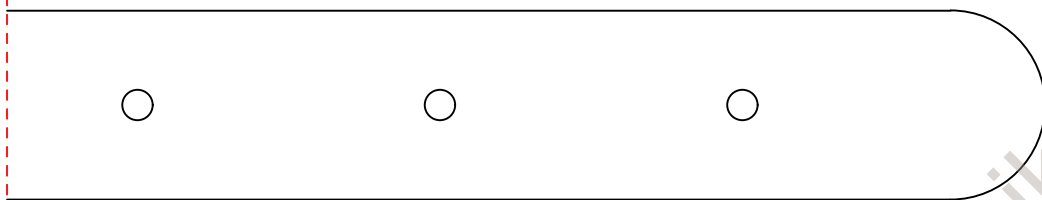
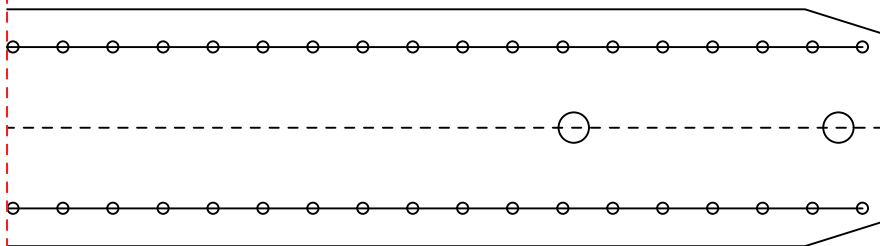
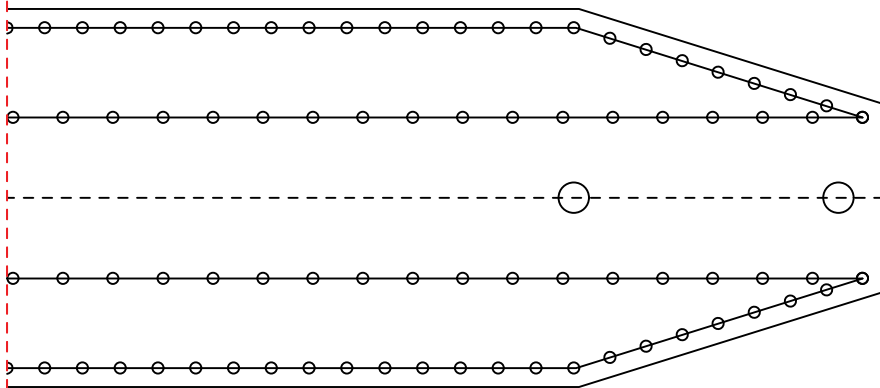

https://vk.com/mark_nikolai_leather

h 1.1

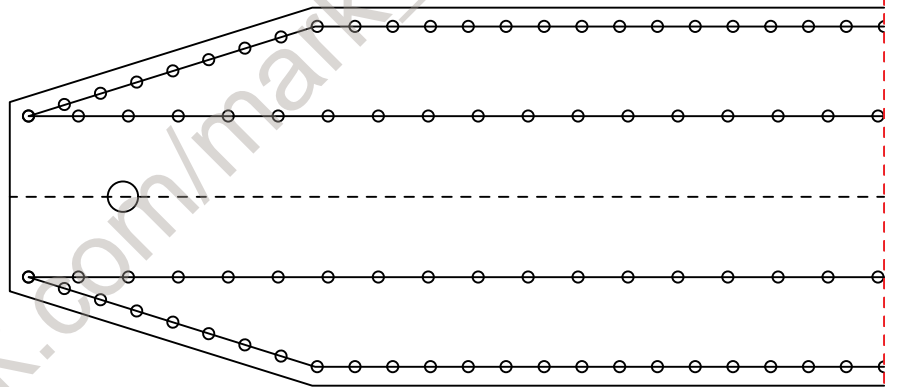
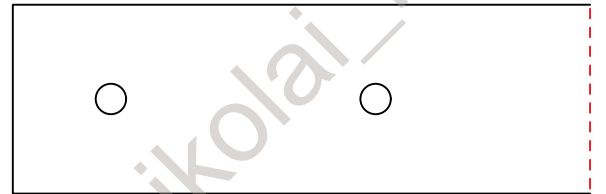
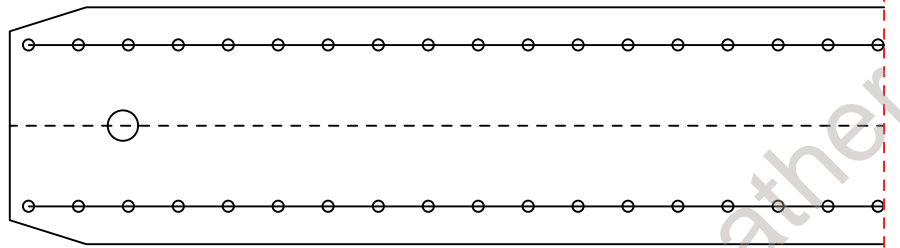
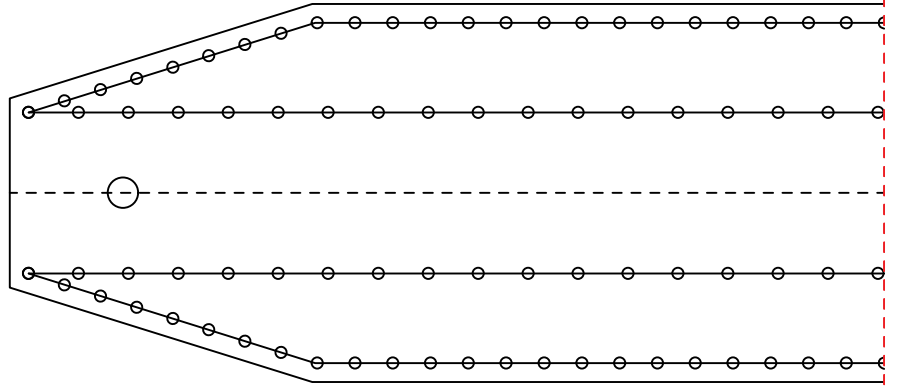
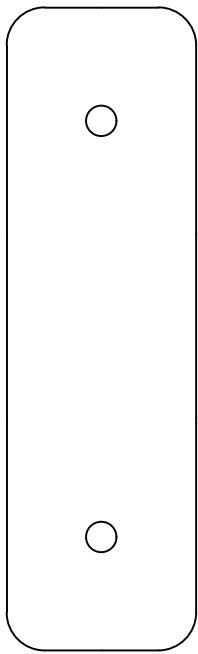

https://vk.com/mark_nikolai_leather

h 1.2

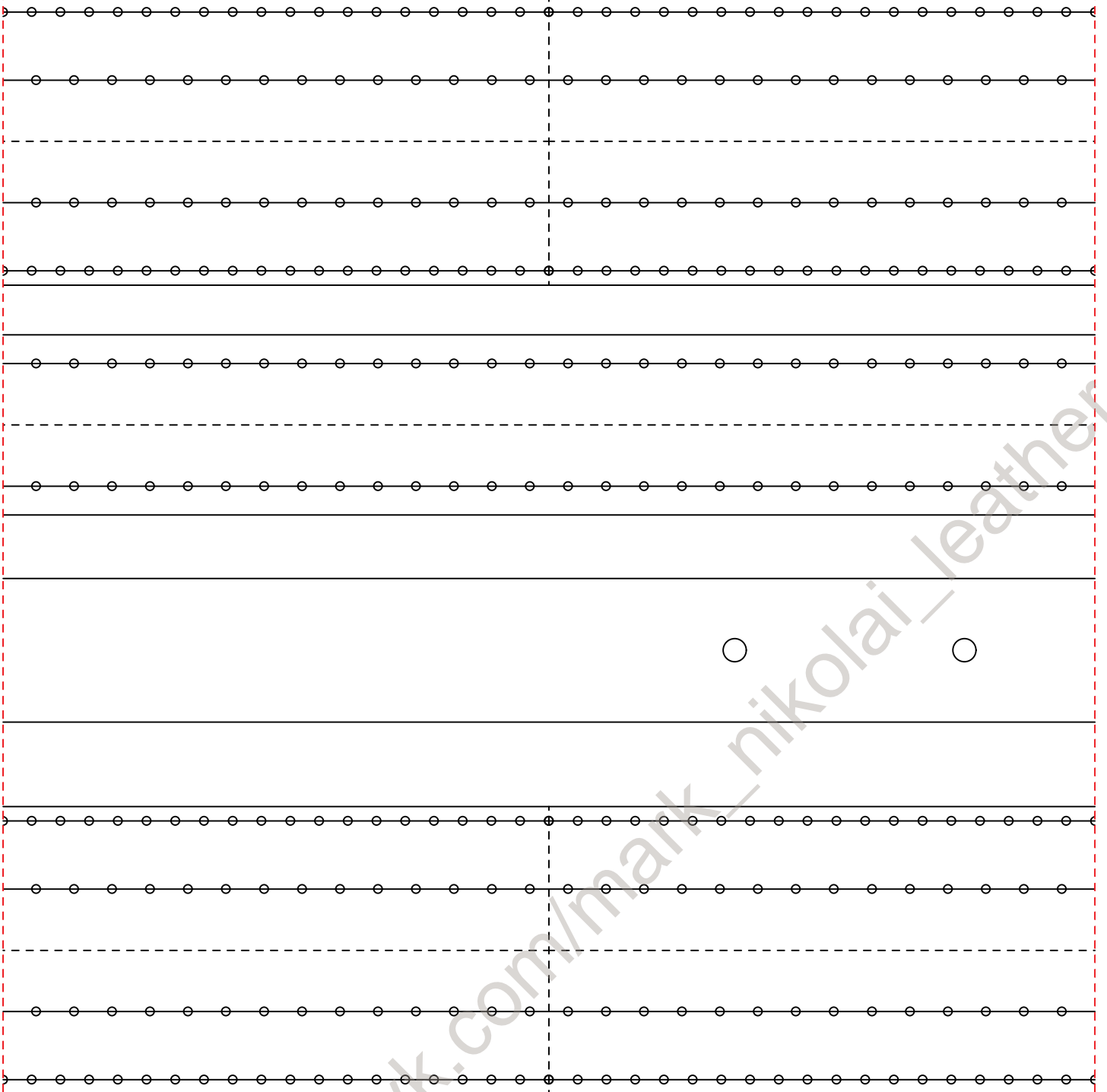

h 1.3

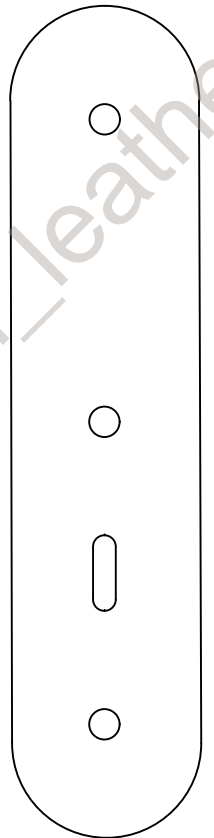
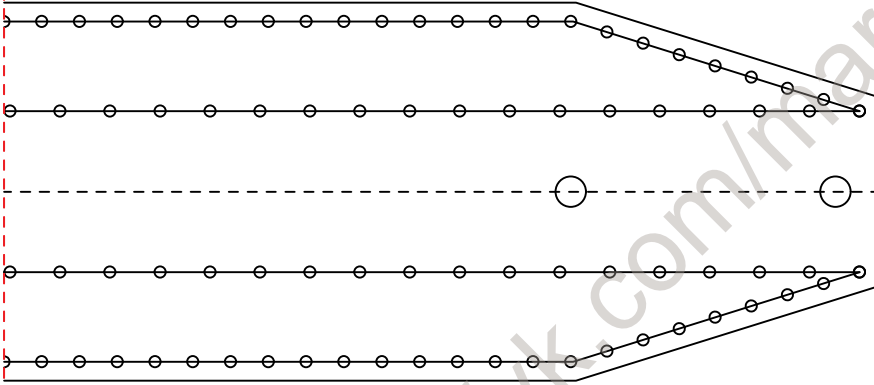
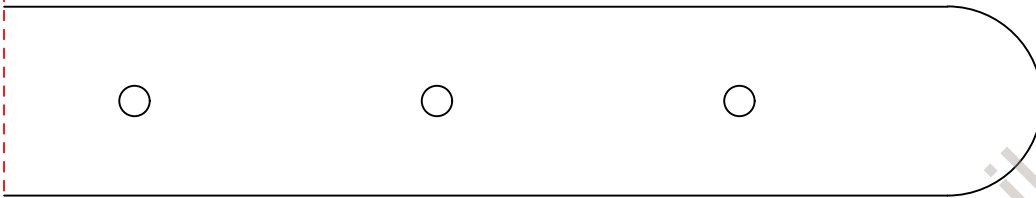
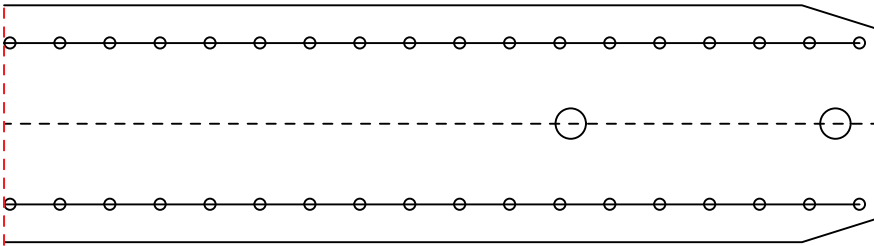
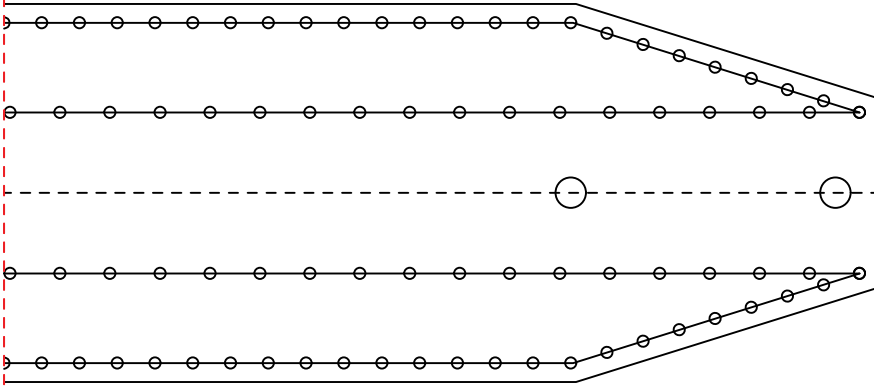

https://vk.com/mark_nikolai_leather

i 1.1



стенка кармана на молнии на
переднюю стенку

https://vk.com/mark_nikolai_leather

i 2.1

https://vk.com/mark_nikolai_leather

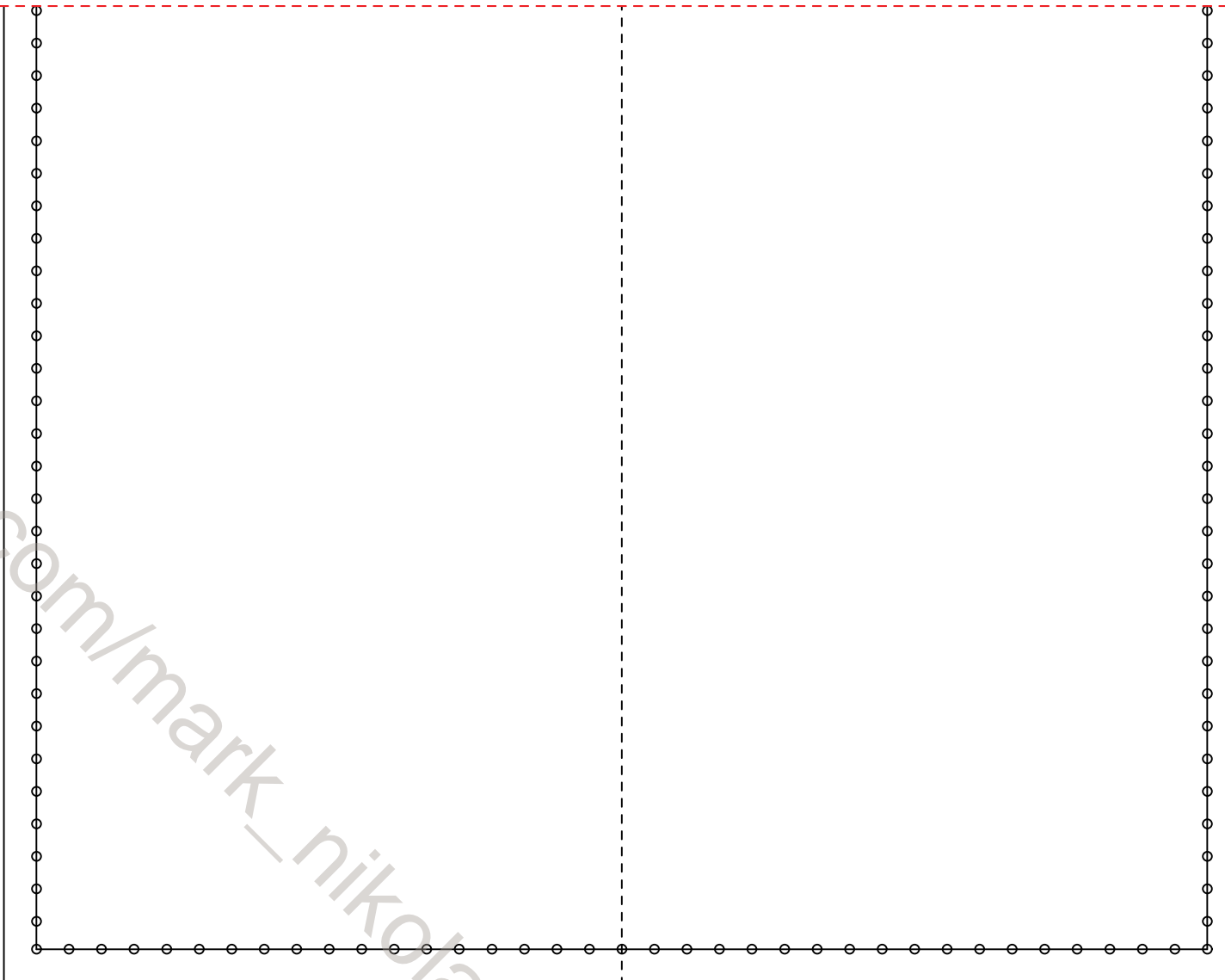

j

карман внутренний на заднюю
стенку

https://vk.com/mark_nikolai_leather