

丸底の巾着バッグ

Drawstring Bag

- ①表面(上) Bag Body (Top panel)
表布・Outer fabric×2

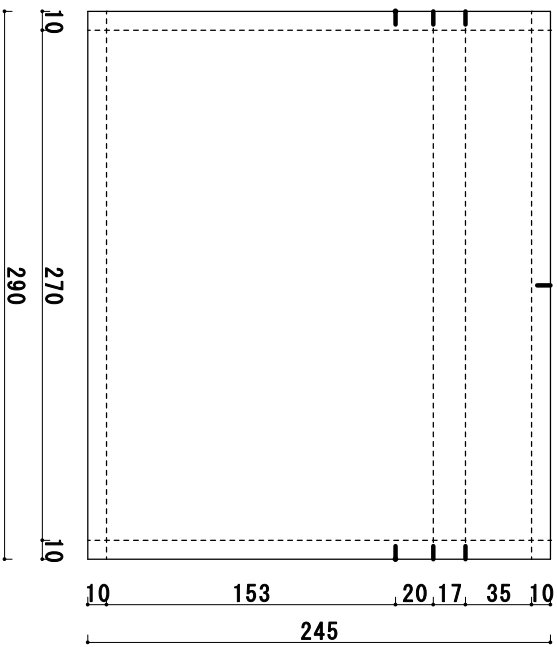

- ③表面(下)・Bag Body (Bottom panel)
表布・Outer fabric×2
接着芯・Interfacing×2

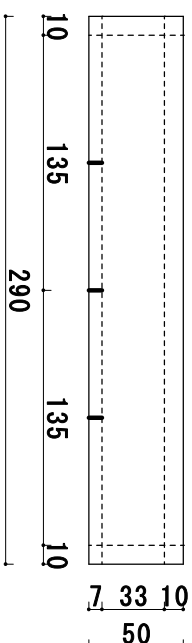

- ⑤裏面(上)・Bag Lining (Top panel) × 2

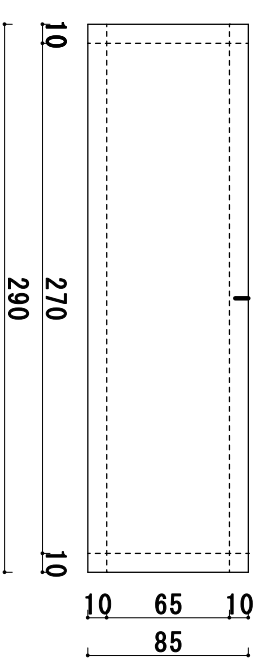

- ④底・Bottom

- 表布・Outer fabric×1
裏布・Lining fabric×1
接着芯・Interfacing×1

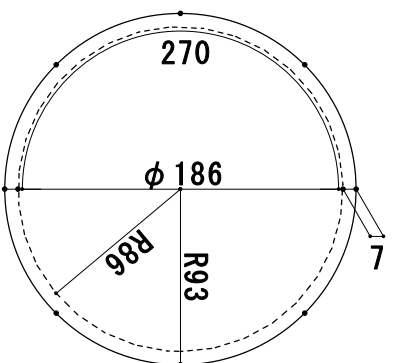

- ⑥裏面(下)・Bag Lining (Bottom panel)

- 裏布・Lining fabric×2

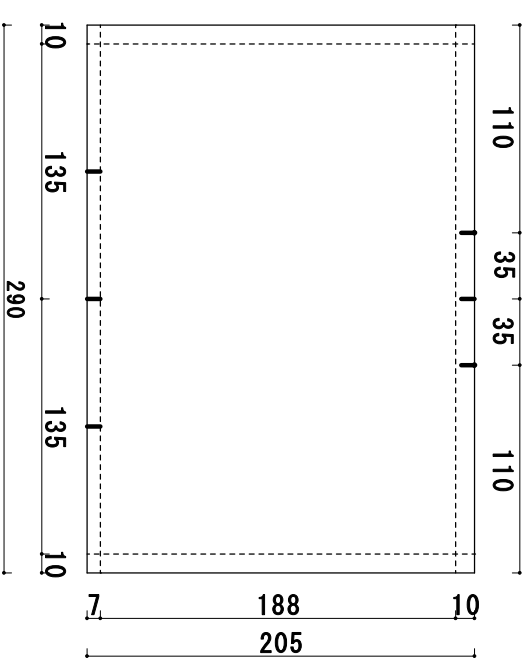

- ②表面(ポケット)・Bag Body (Pocket)
表布・Outer fabric×2
裏布・Lining fabric×2

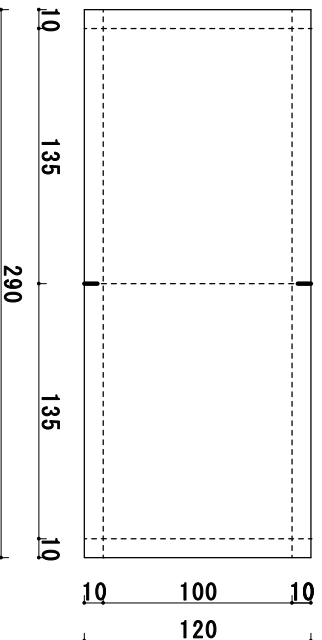

縫い代込みの型紙になります。

The seam allowance is included in the pattern.

⑦表布(持ち手)・Outer fabric(Handle) × 2

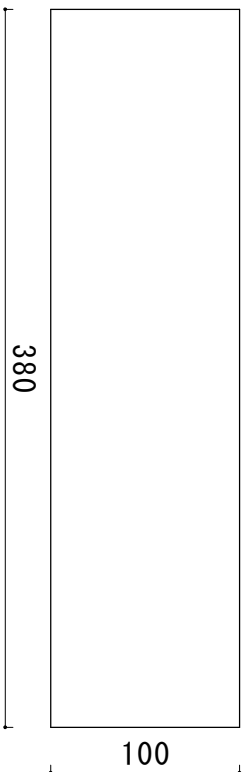

※ショルダーストラップを付けず、ハンドバッグとしてお使いになる場合、長さは41~44cm程度がお勧めです。38cmの長さでは冬服で腕に掛けると、時に少し窮屈な感じが持ち手が邪魔にならず使いやすいと思います。

If you do not attach a shoulder strap and use it as a handbag, I recommend a length of 41 cm~44 cm (16 1/8"~17 1/4"). The length of 38cm is a little narrow to hang a bag on the arm. When using with a shoulder bag, 38cm is recommended because it does not get in the way.

⑧表布(ショルダー紐)・Outer fabric(Shoulder strap) × 1

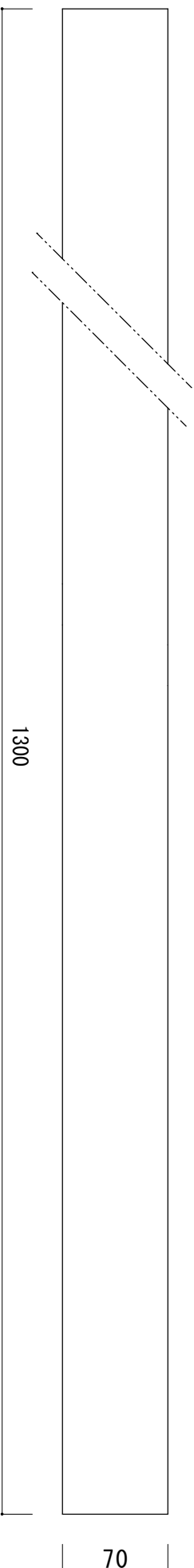

⑨表布(15mmDカンタブ)・Outer fabric(15mm D ring loop) × 2

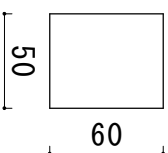

①-1

①-1と①-2を繋げて下さい。

Connect①-1and①-2

①表面(上) Bag Body (Top panel)

表布・Outer fabric x 2

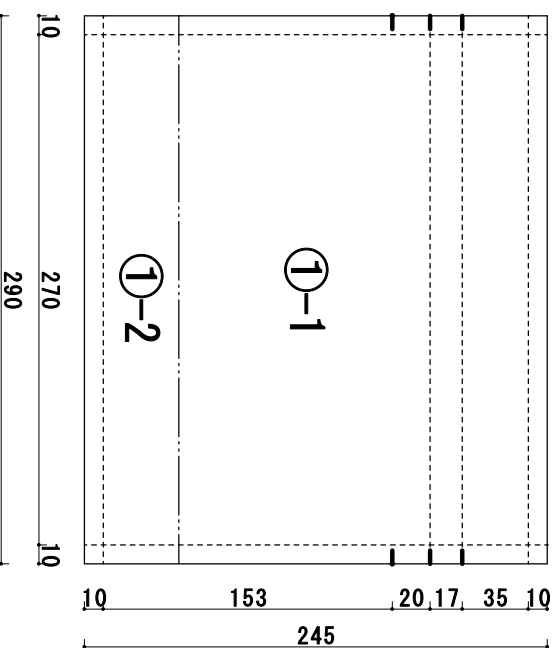

①-2

切り取り線 Cut line

②

②表面(ポケット)・Bag Body (Pocket)

表布・Outer fabric×2

裏布・Lining fabric×2

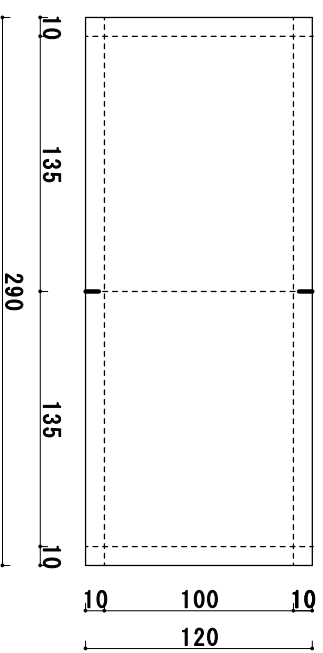

③表面(下)・Bag Body (Bottom panel)

表布・Outer fabric×2 接着芯・Interfacing×2

③

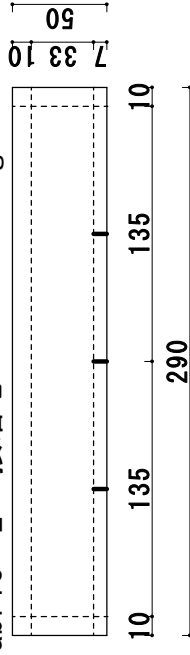

切り取り線 Cut line

⑤裏面(上)・Bag Lining (Top panel) × 2

⑤

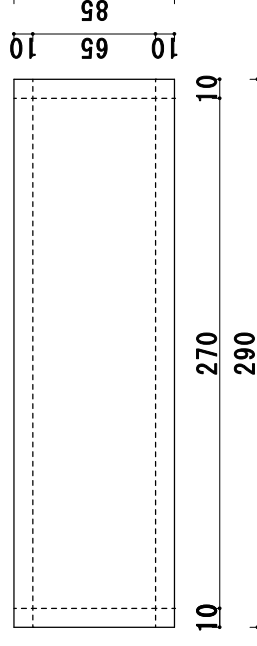

切り取り線 Cut line

⑥-2

4

④底 · Bottom
表布 · Outer fabric x 1
裹布 · Lining fabric x 1
接着芯 · Interfacing x 1

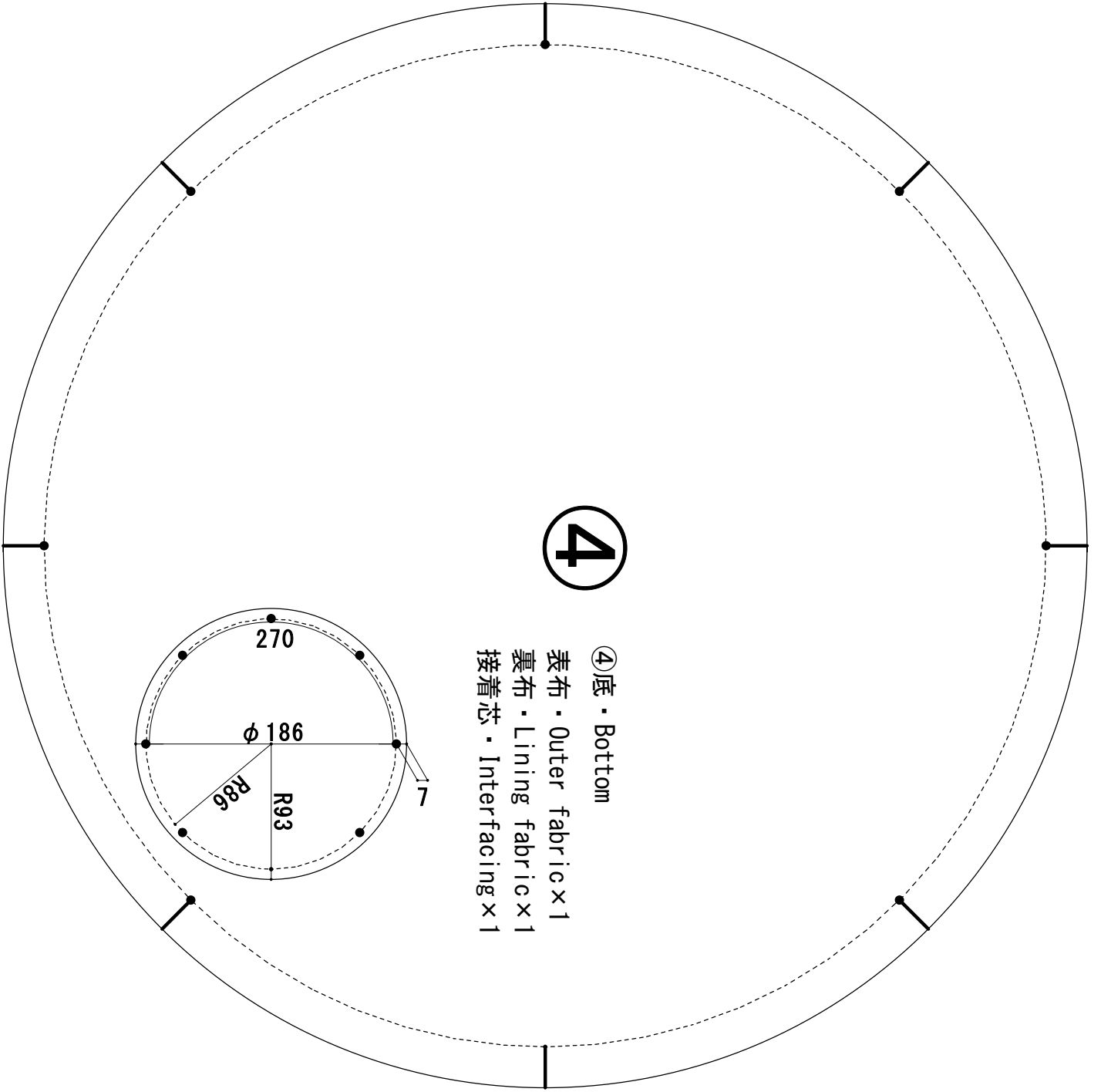
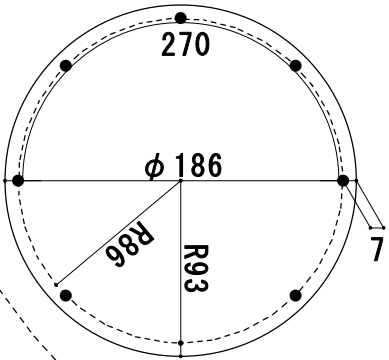

⑥-1

⑥-1と⑥-2を繋げて下さい。
Connect⑥-1and⑥-2

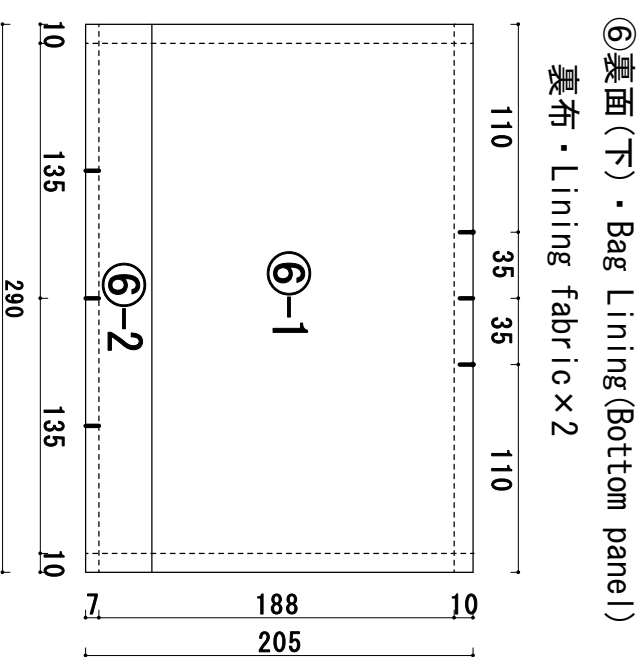

⑦-1

⑦表布(持ち手)・Outer fabric(Handle) × 2

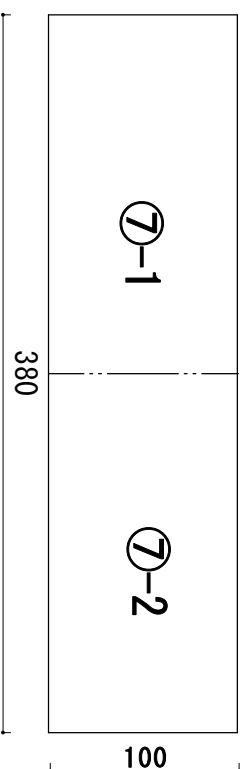

⑦-1と⑦-2を繋げて下さい。

Connect⑦-1and⑦-2

⑦-2

物差しで長さが合っているか確認して下さい。

Check if the length is correct with a ruler.

長さが合わない場合、印刷設定の倍率(又は拡大縮小)で「ページ(用紙)サイズに合わせる」のチェックをはずし、「実際のサイズ」または「カスタム100%」で印刷して下さい。

If the length does not fit, uncheck

“Fit to page (paper)” in the print settings magnification or scaling.

Then print with “Actual size” or “Custom 100%”.

5cm (1.97")

⑨

⑨表布(15mmDカシタマ)
Outer fabric
(15mm D ring loop) × 2

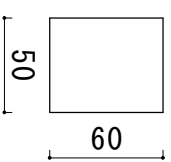

6cm (2.36")