

# *Test Page*

*Page Size: Actual size*  
*Page Setupe: A4*

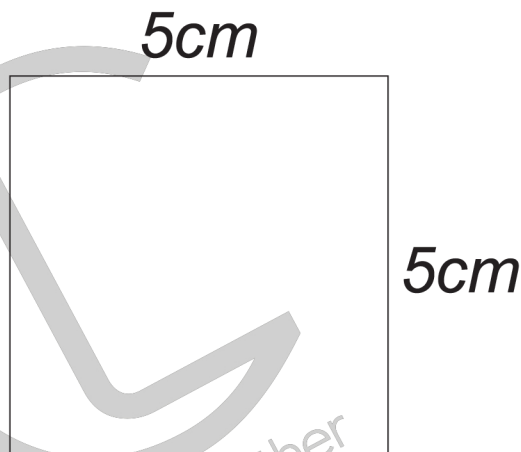

*Measure with ruler*  
*if exactly every side of*  
*the square was 5cm,*  
*so you printed correctly*

با خط کش اندازه بگیرید  
اگر دقیقا هر سمت مربع پنج سانت بود  
پس درست پرینت کردید

Caspia Leather

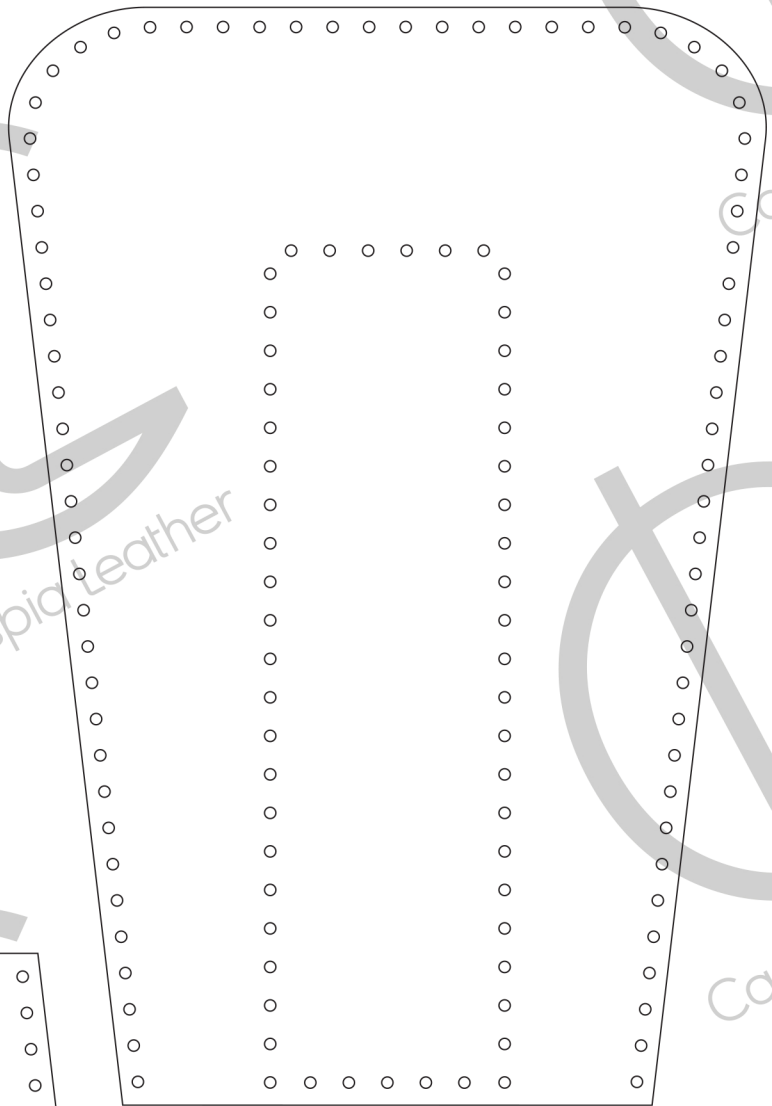
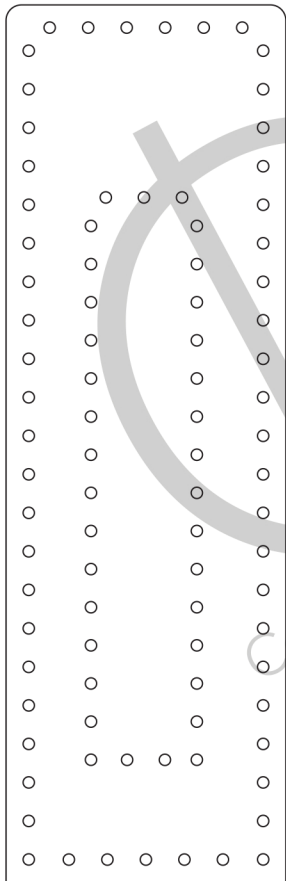

Leather

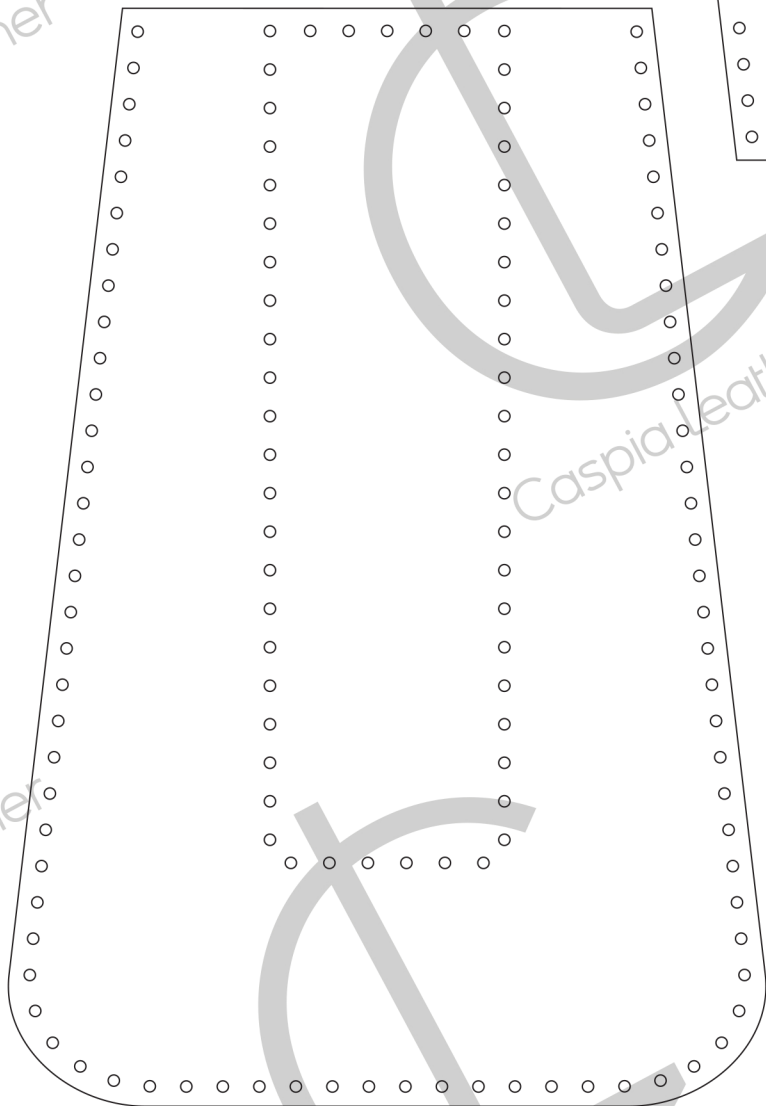

Caspia Leather

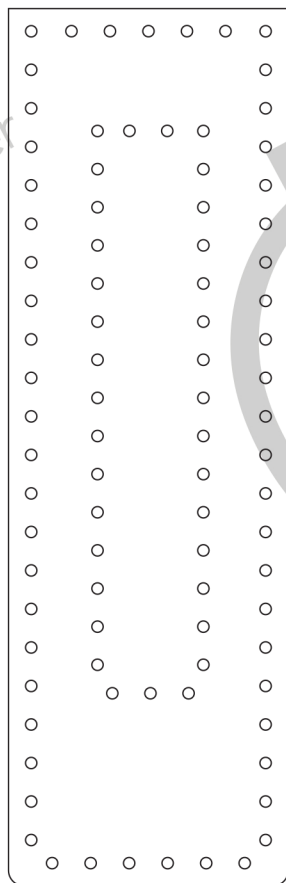

Leather

Caspia Leather

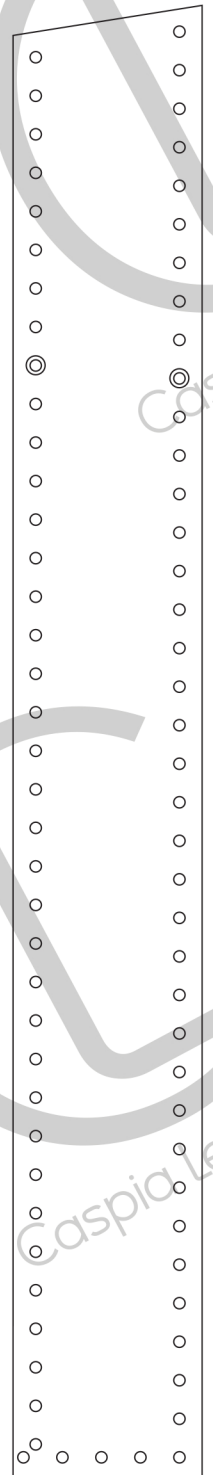
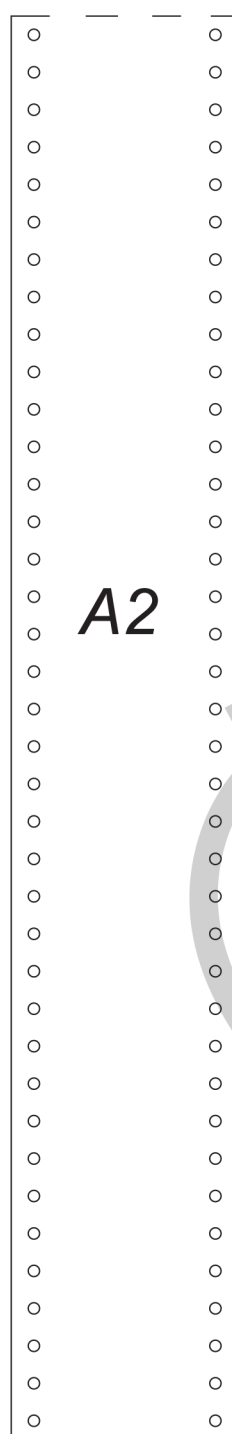
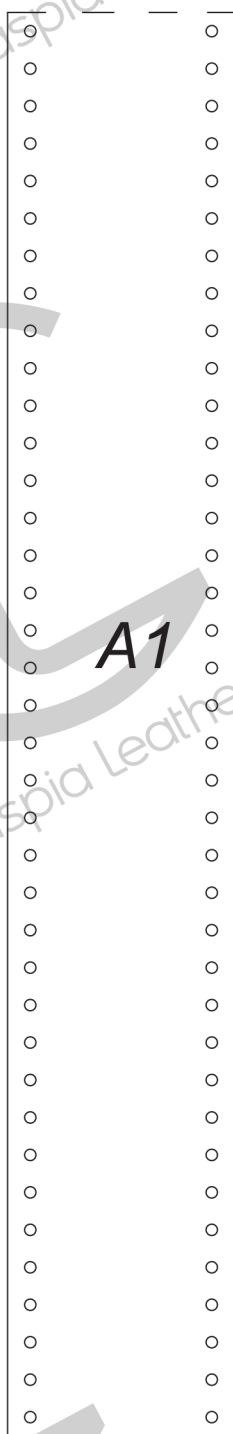
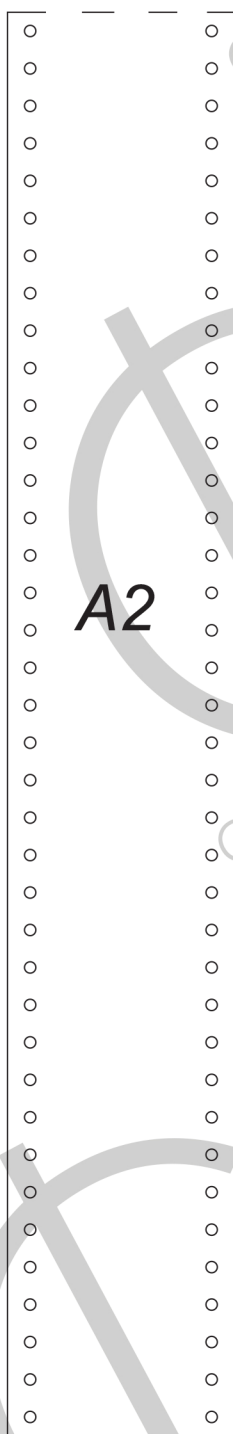
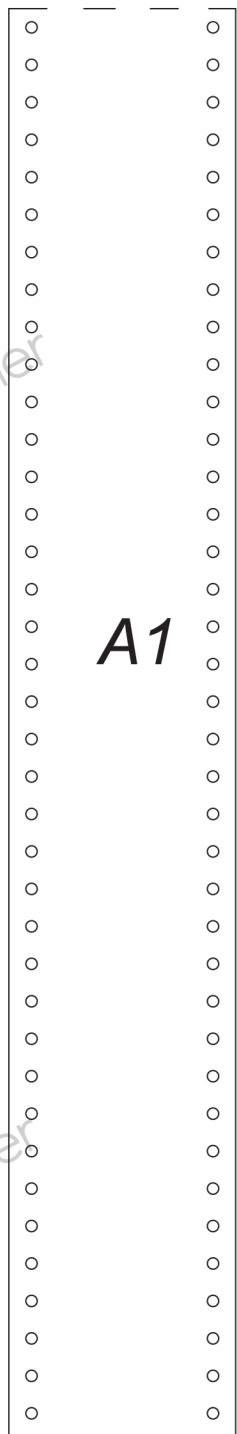
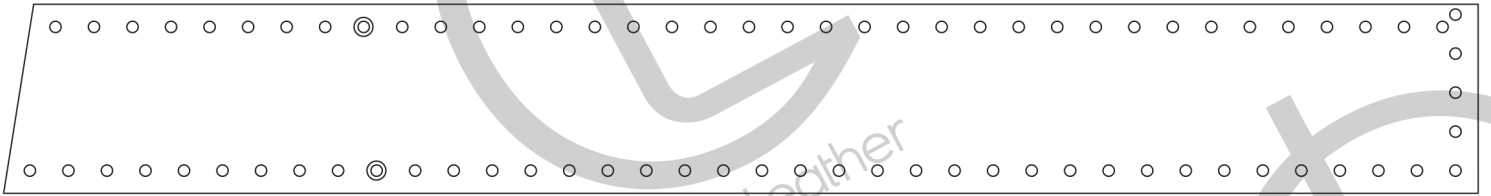

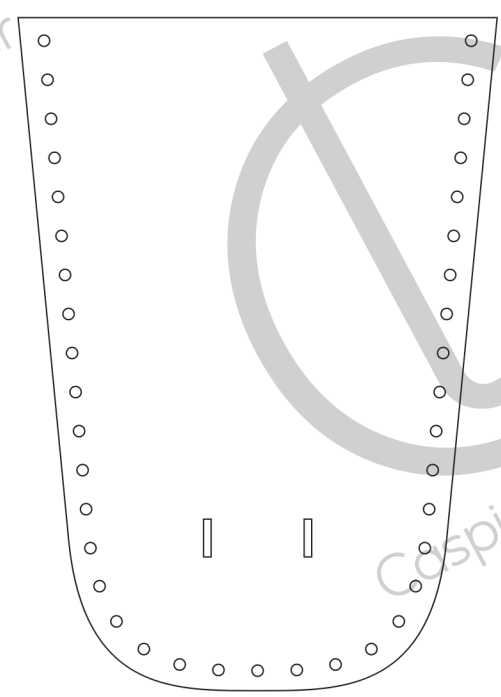
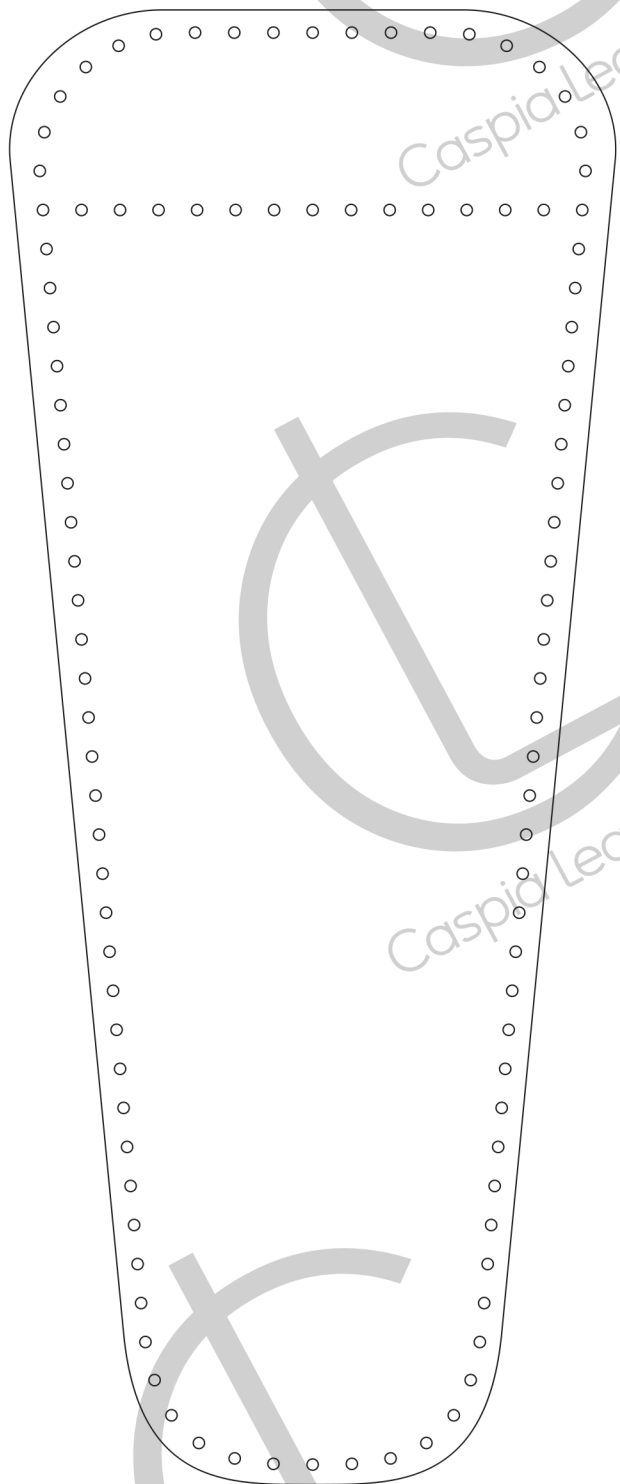
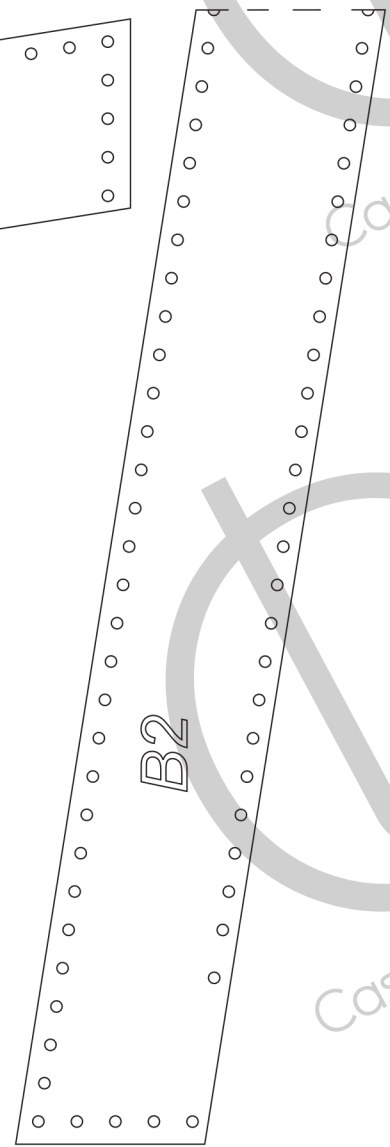
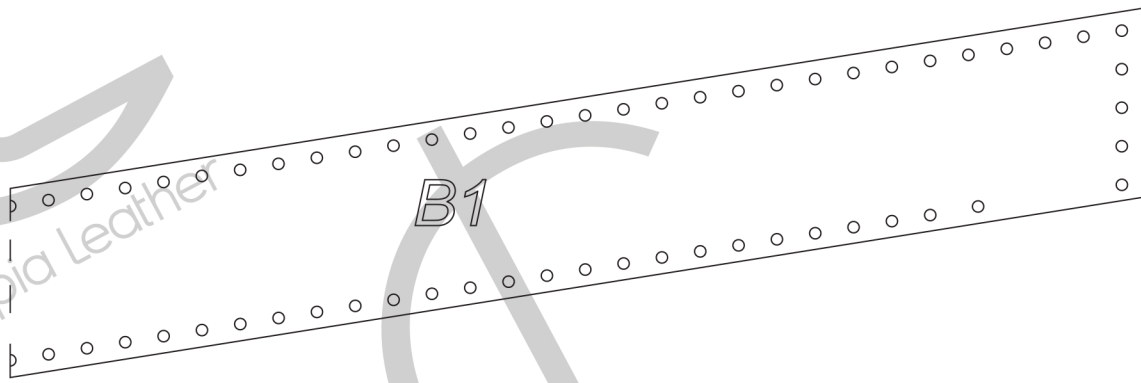



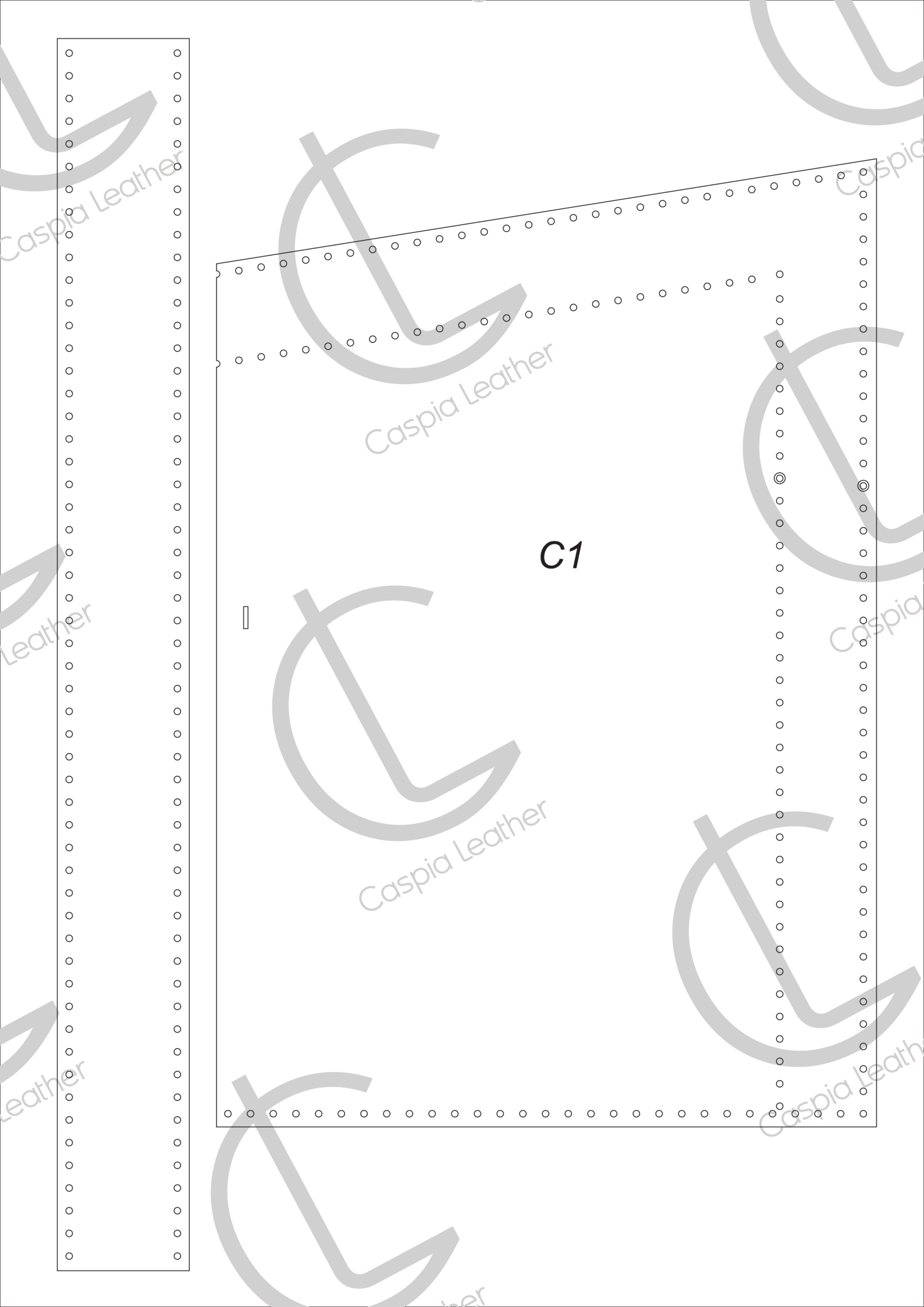

Caspia Leather

Caspia Leather

Leather

Caspia

Leather

Caspia Leather

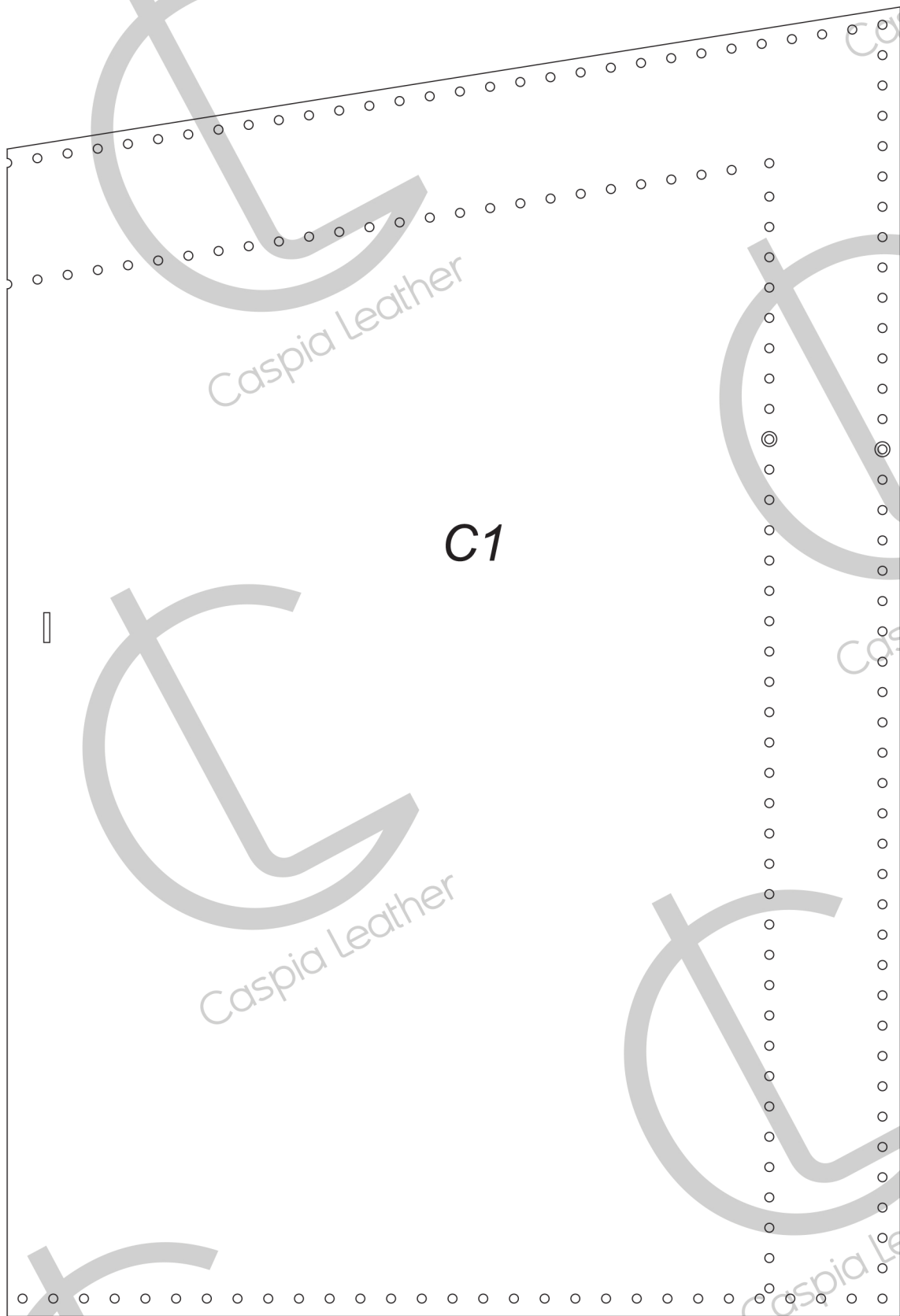
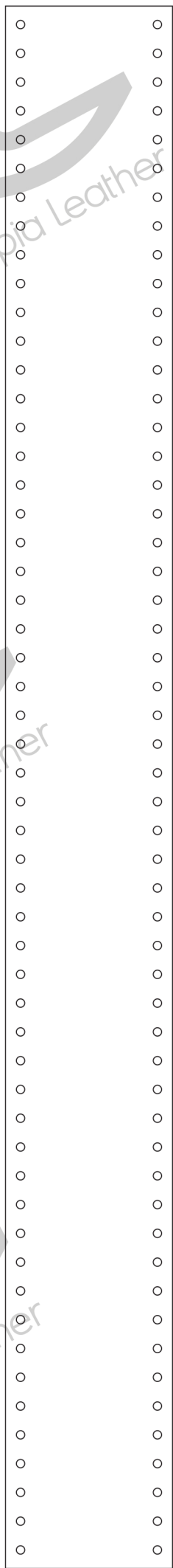

**C1**



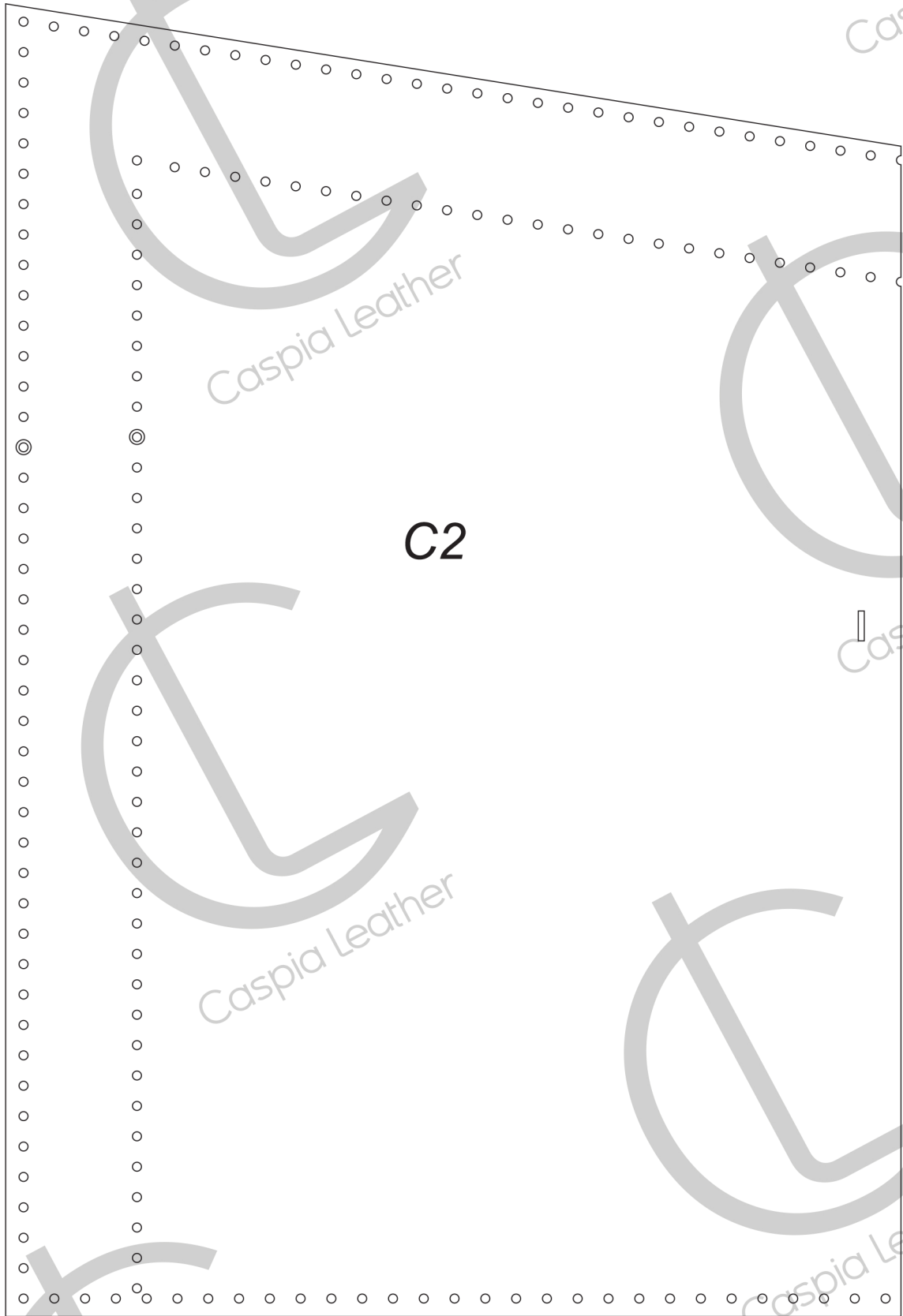
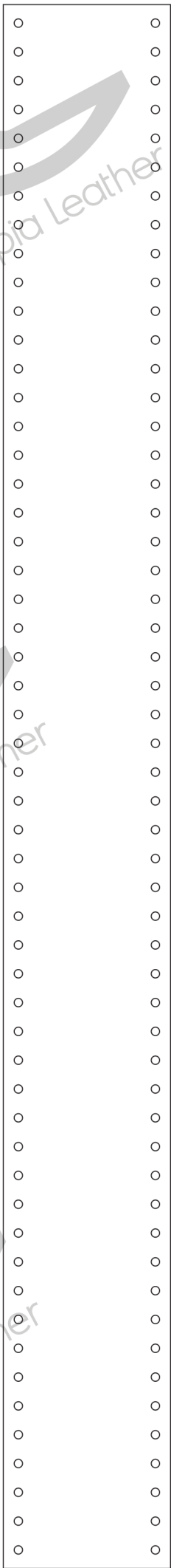
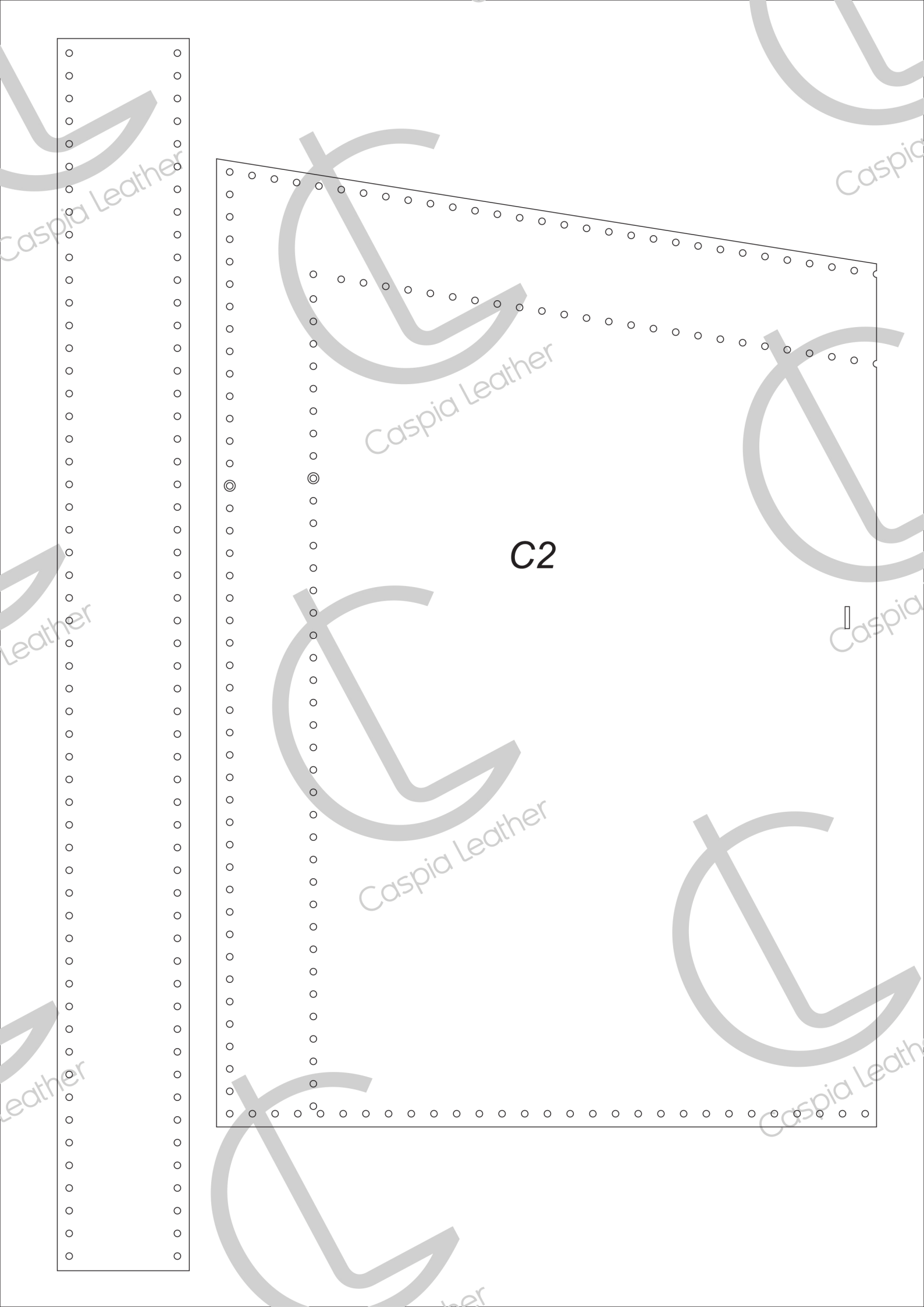

C2

Caspia Leather

Caspia

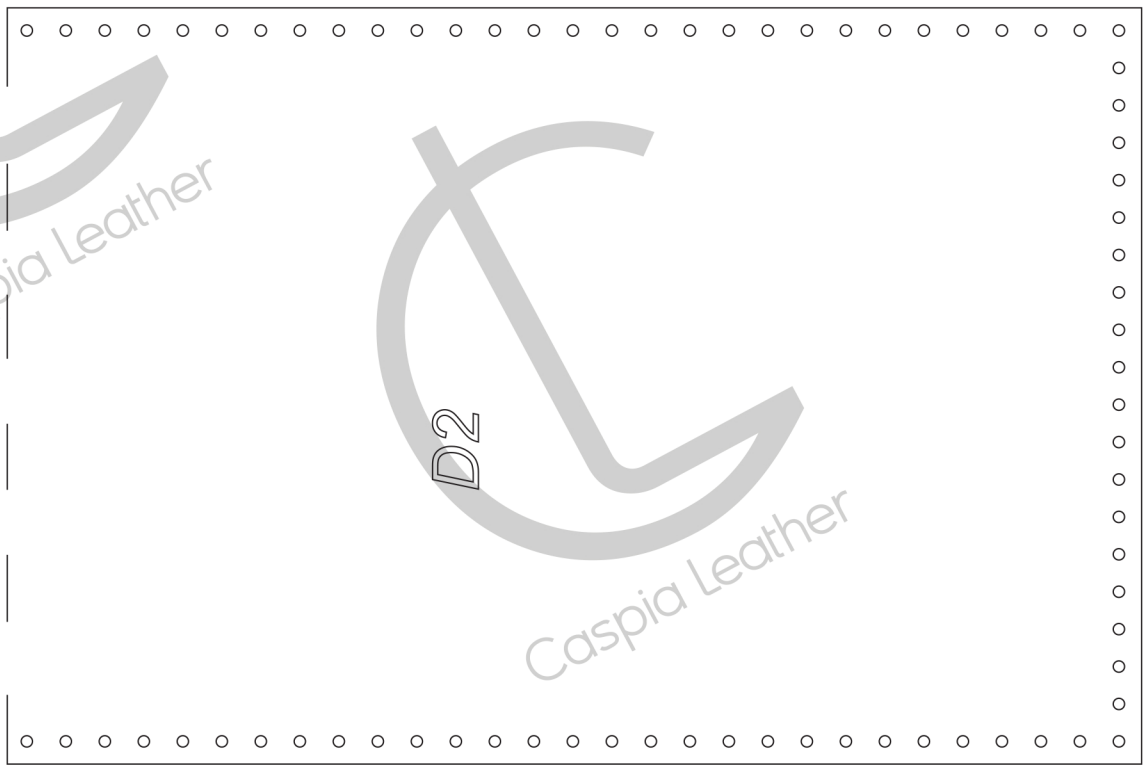

D2

Caspia Leather

Leather

Caspia

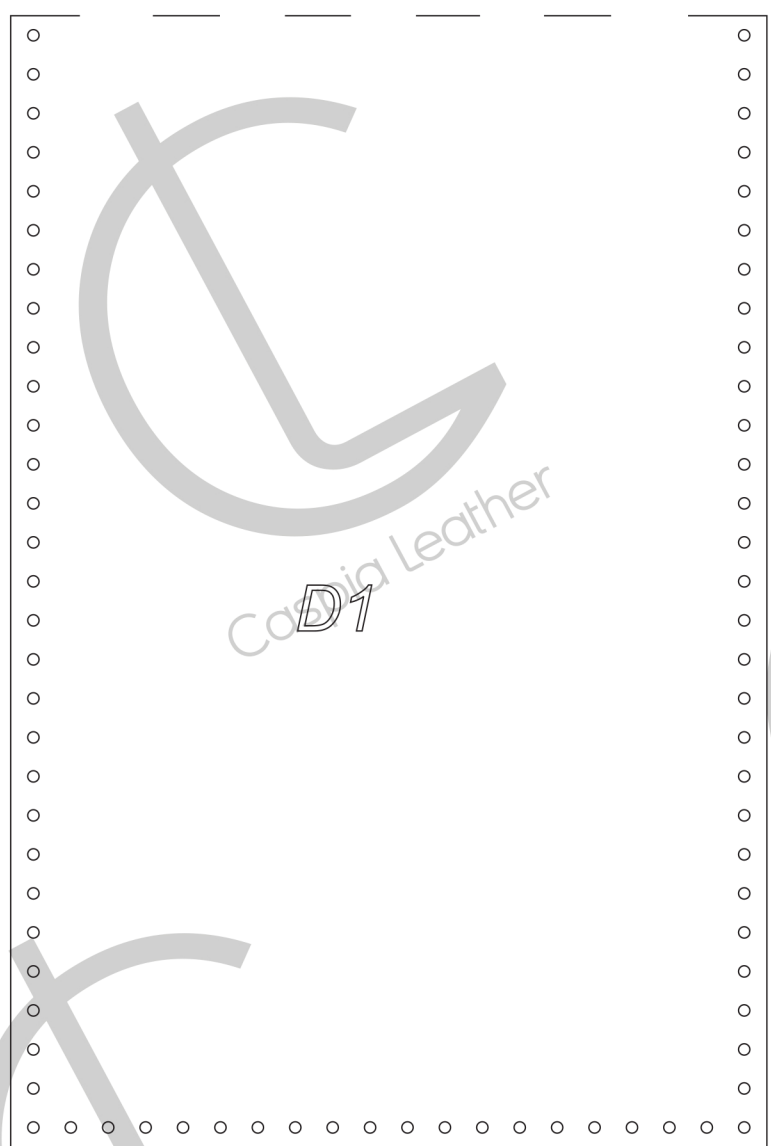

D1

Caspia Leather

Leather

Caspia Leather

her

Caspia Leather

Caspia

Caspia Leather

Leather

Caspia

Caspia Leather

Leather

Caspia Leather

***E1***

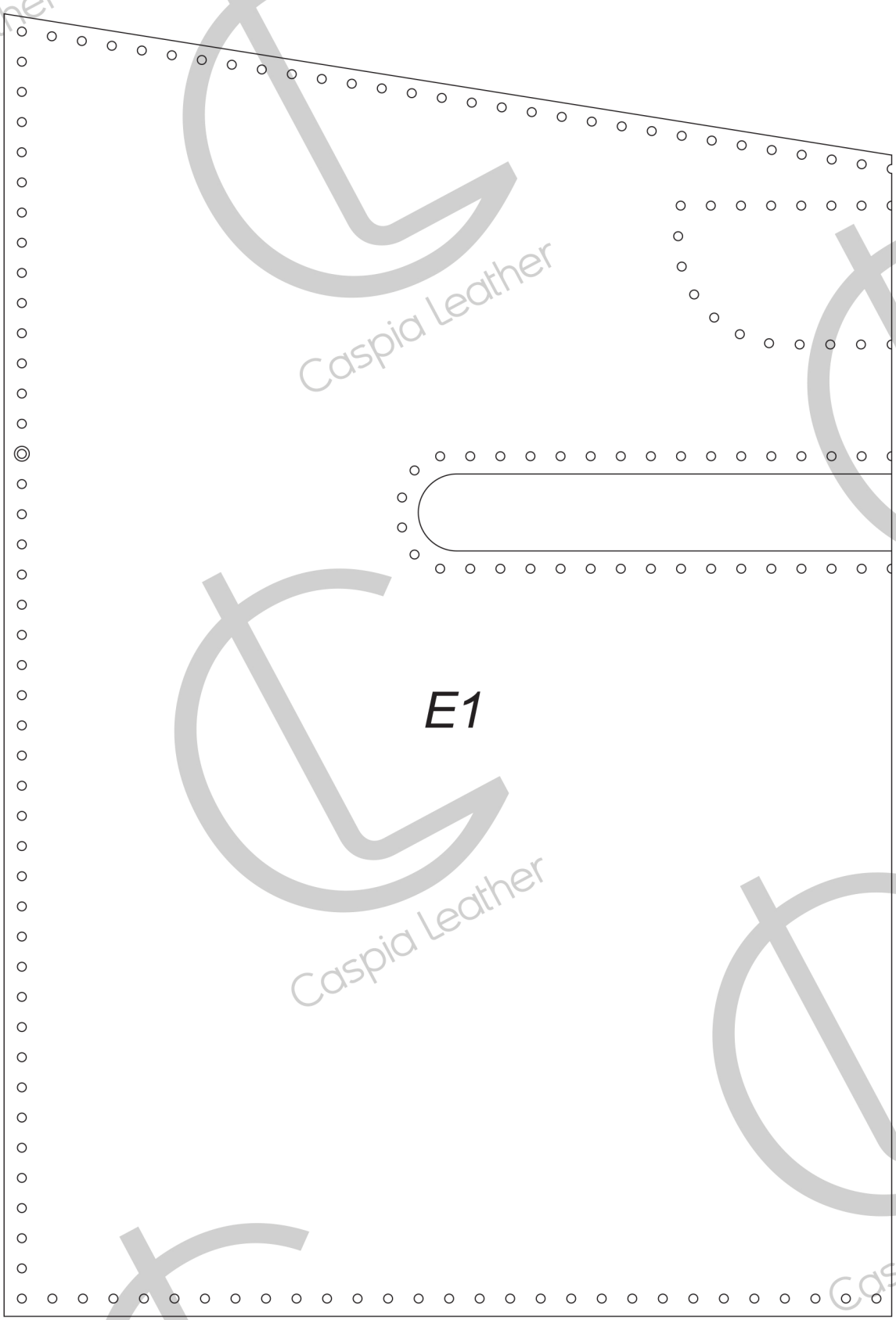

Caspia Leather

Caspia

Caspia Leather

Leather

Caspia

Caspia Leather

Leather

Caspia Leather

**E2**

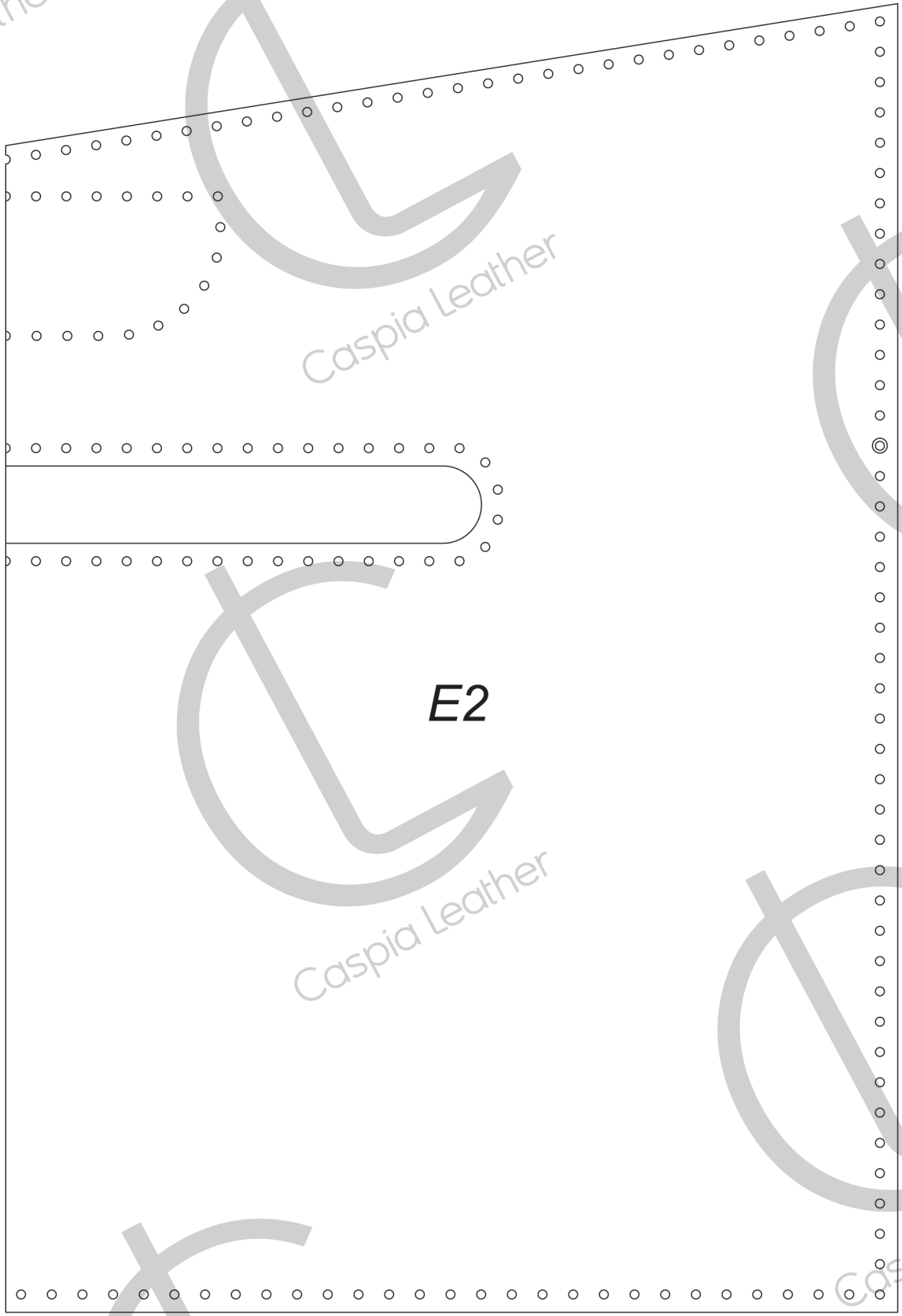

Caspia Leather

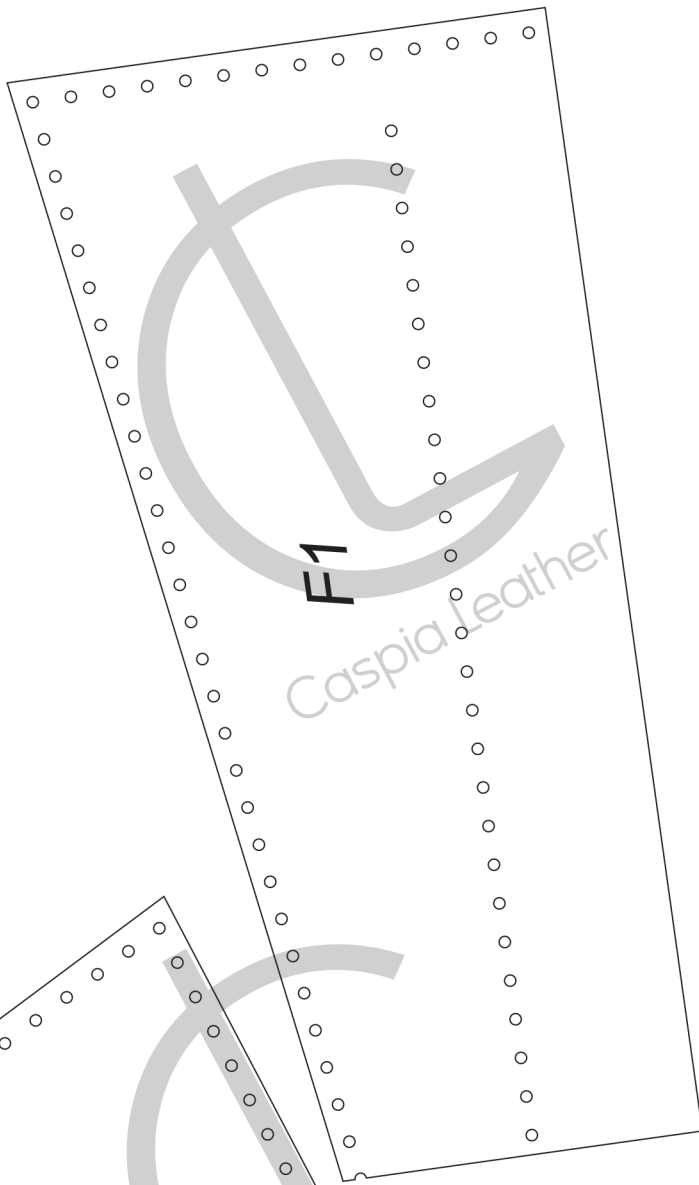

Leather

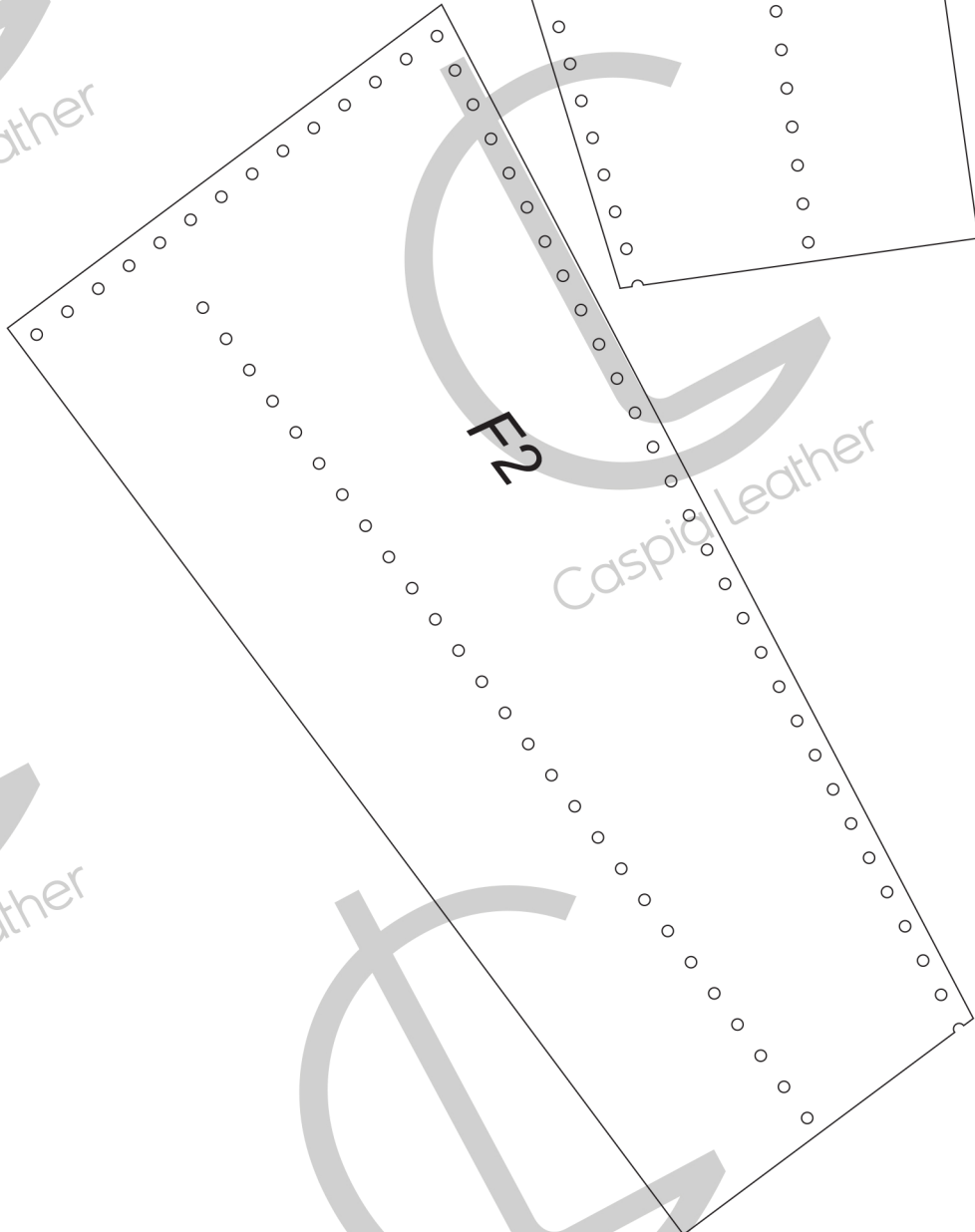

Leather

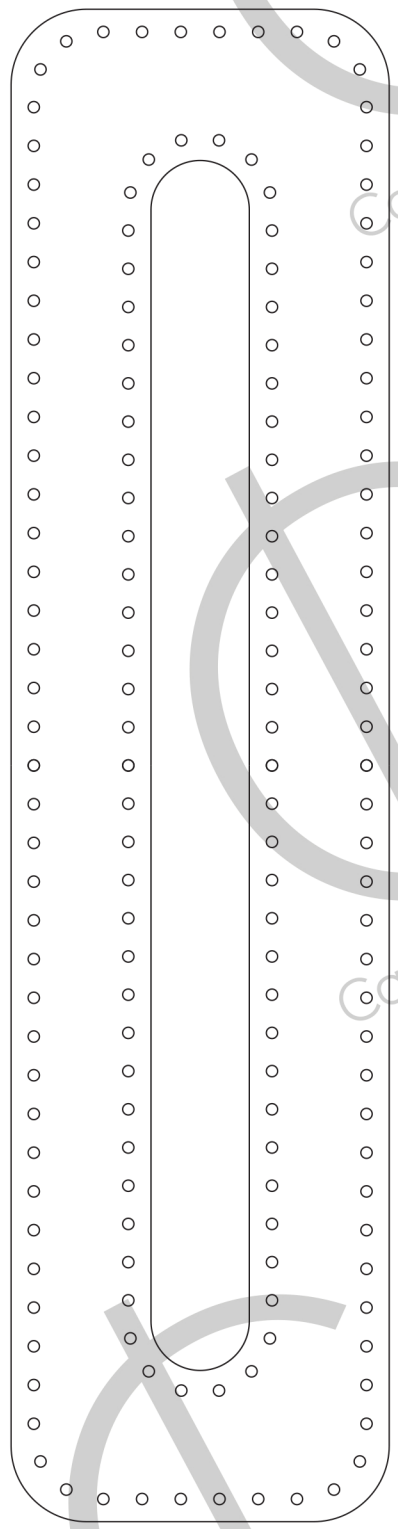

Caspia Leather

Caspia Leather

Caspia

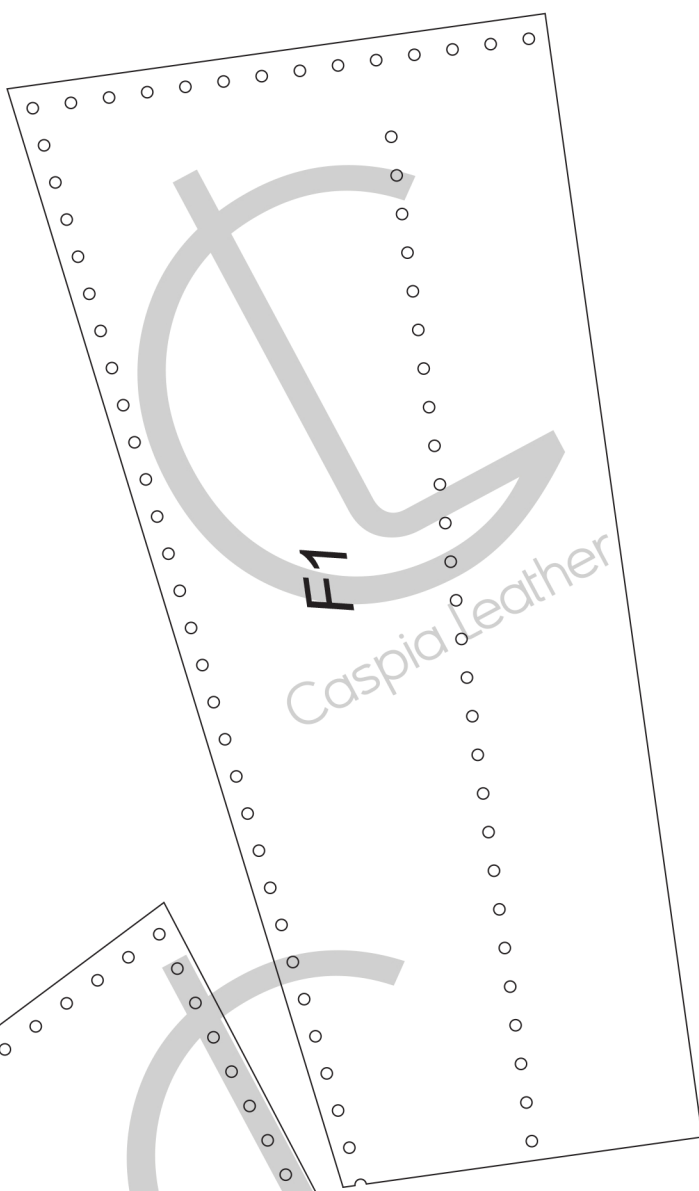

Leather

Caspia

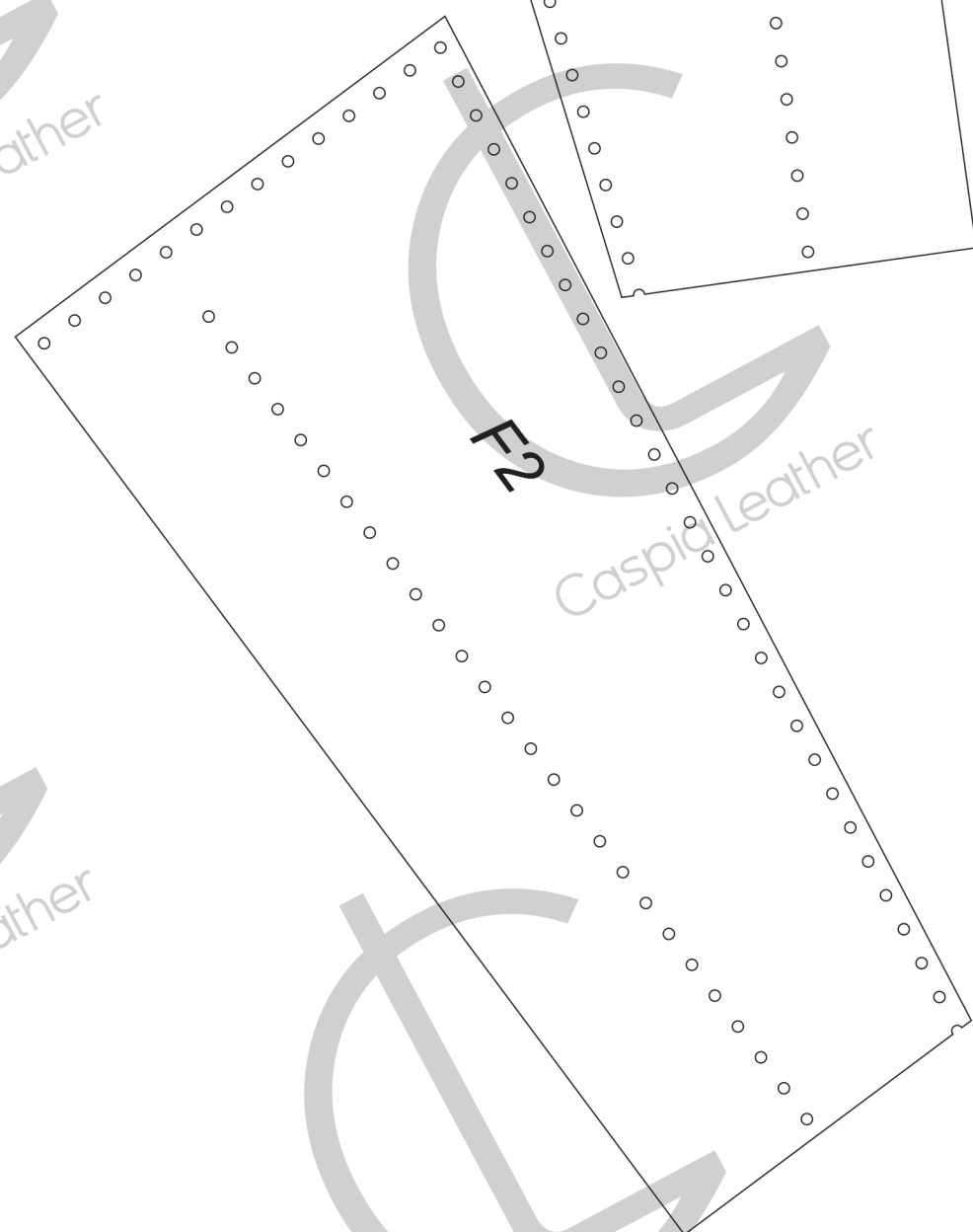

Leather

Caspia Leather

her

