



PRINTING INSTRUCTION

1. File > Print
2. Click on “Page Setup” button make sure your paper size is set to the paper size that you will print and Scale at 100%
3. In “Pages Sizing & Handling” click on “Size” button and select “Actual size”

Select Actual size

Select the paper size

Scale 100%

Set the paper size

IMPORTANT NOTE:

- **ADOBE ACROBAT READER (FREE SOFTWARE)** is recommended to open and print the patterns

link for free download

<https://get.adobe.com/reader>

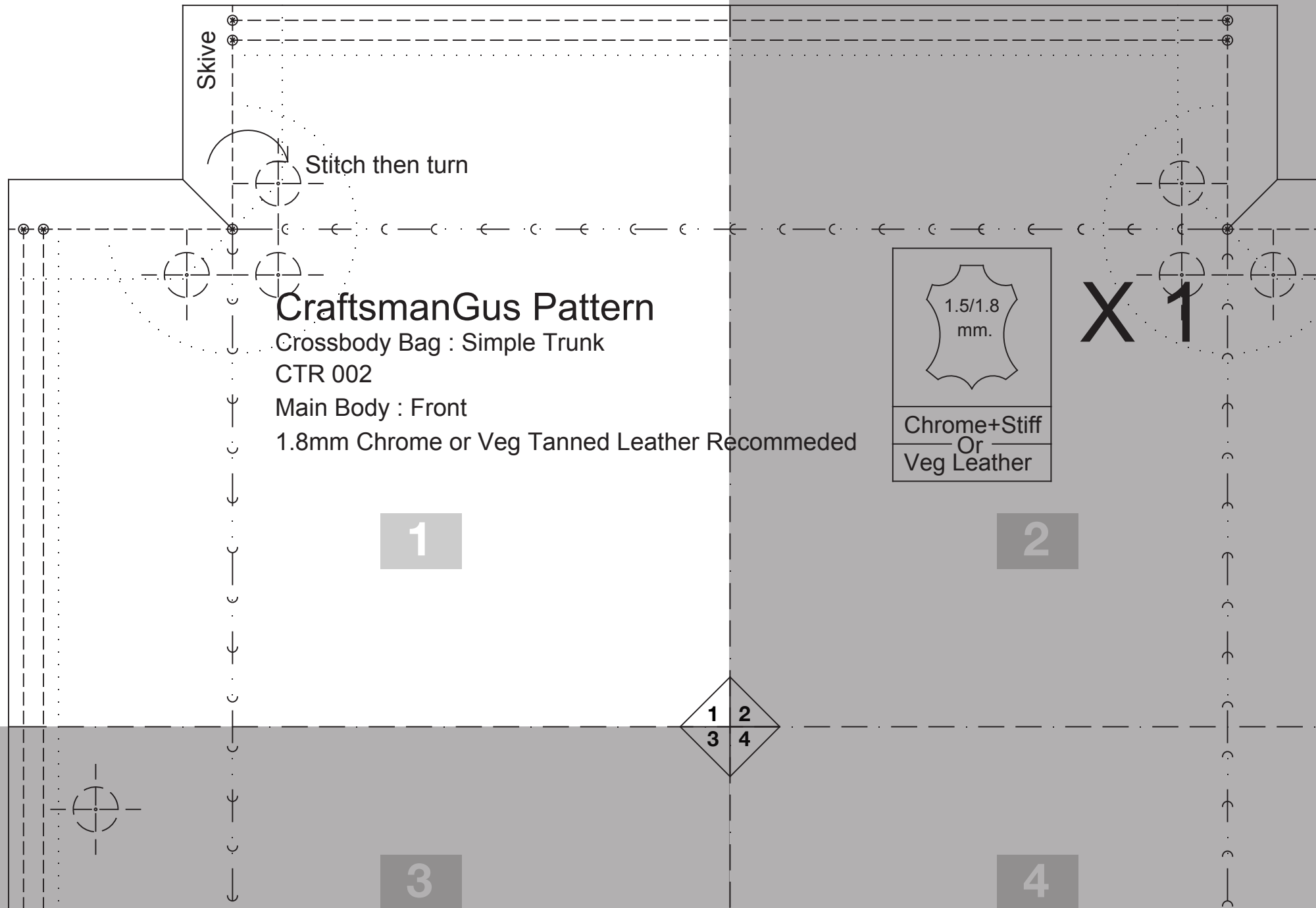

Skive

Stitch then turn

CraftsmanGus Pattern

Crossbody Bag : Simple Trunk
CTR 002

Main Body : Front
1.8mm Chrome or Veg Tanned Leather Recommended

1.5/1.8 mm.
Chrome+Stiff Or Veg Leather

X 1

1

2

1 2
3 4

3

4

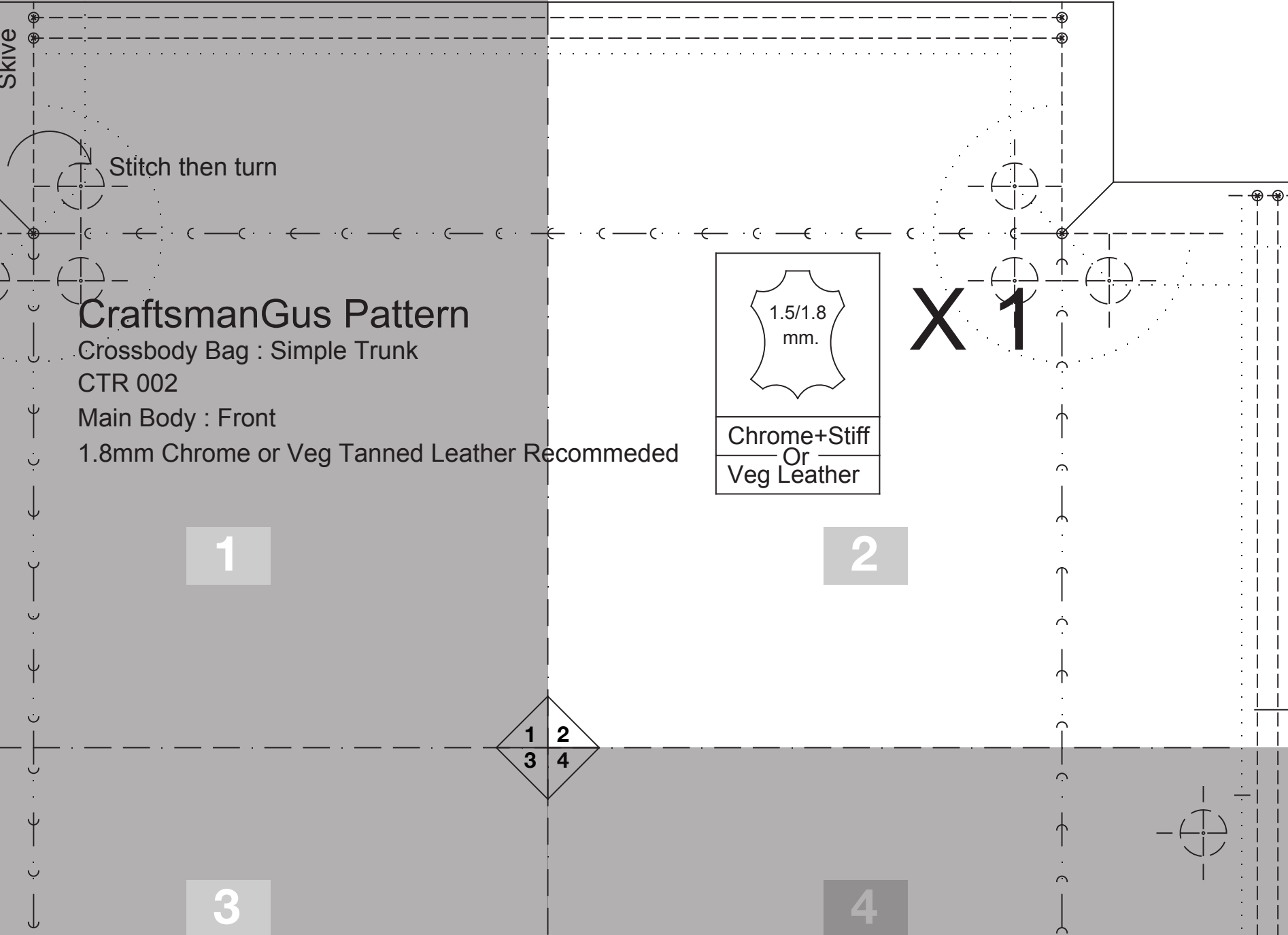

Skive

Stitch then turn

CraftsmanGus Pattern

Crossbody Bag : Simple Trunk
CTR 002

Main Body : Front

1.8mm Chrome or Veg Tanned Leather Recommended

1.5/1.8 mm.
Chrome+Stiff Or Veg Leather

X 1

1

2

1	2
3	4

3

4

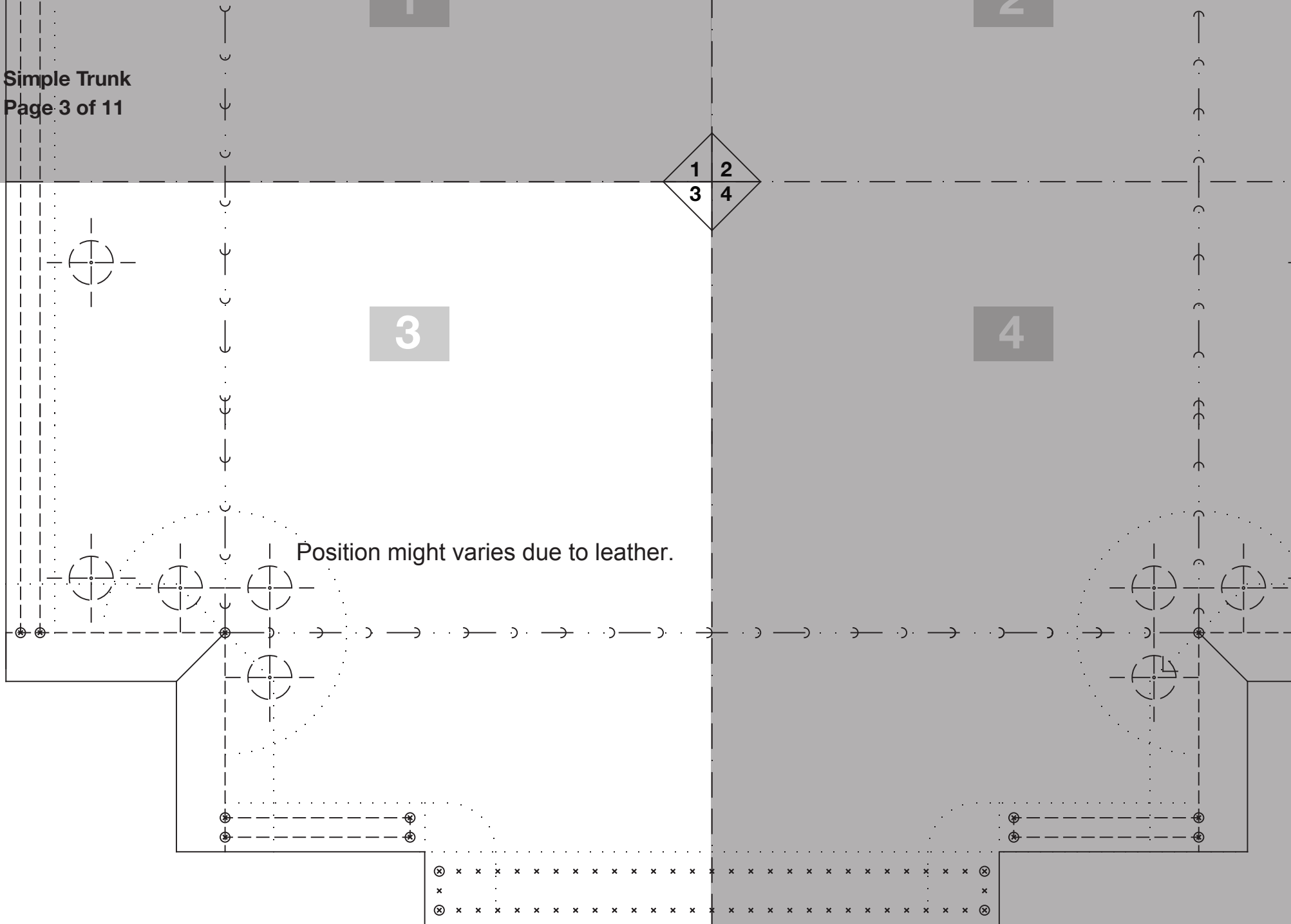



3

4

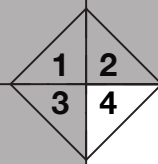

Position might varies due to leather.

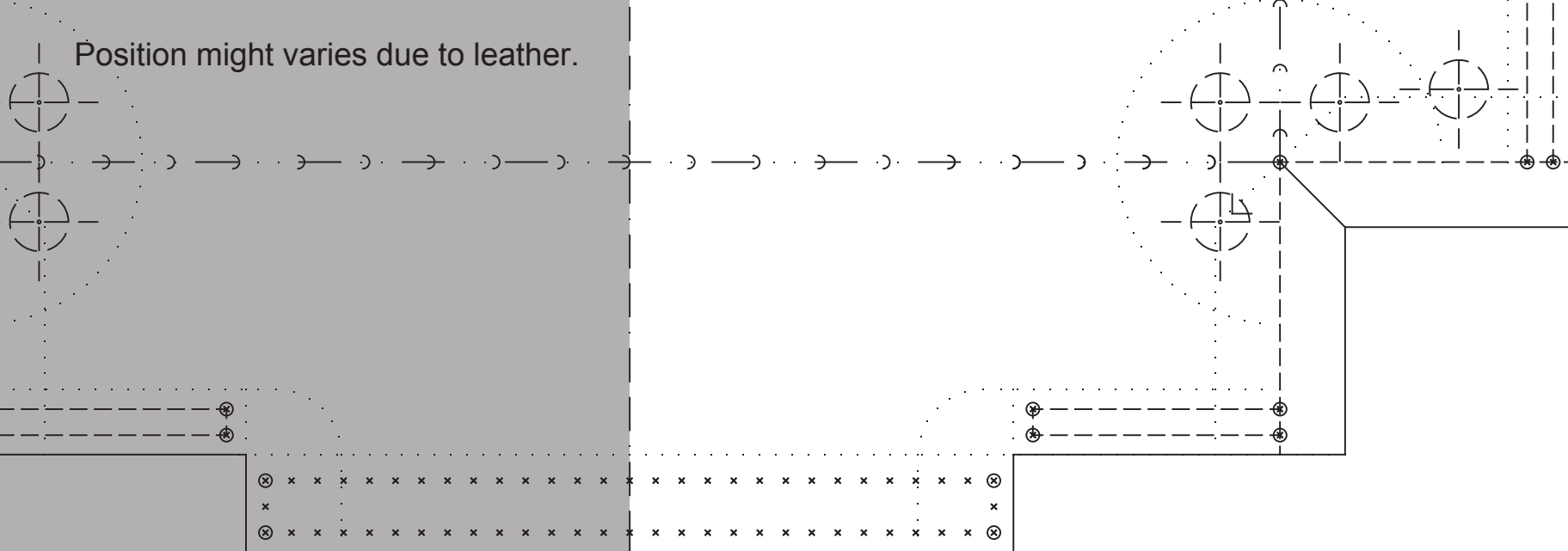

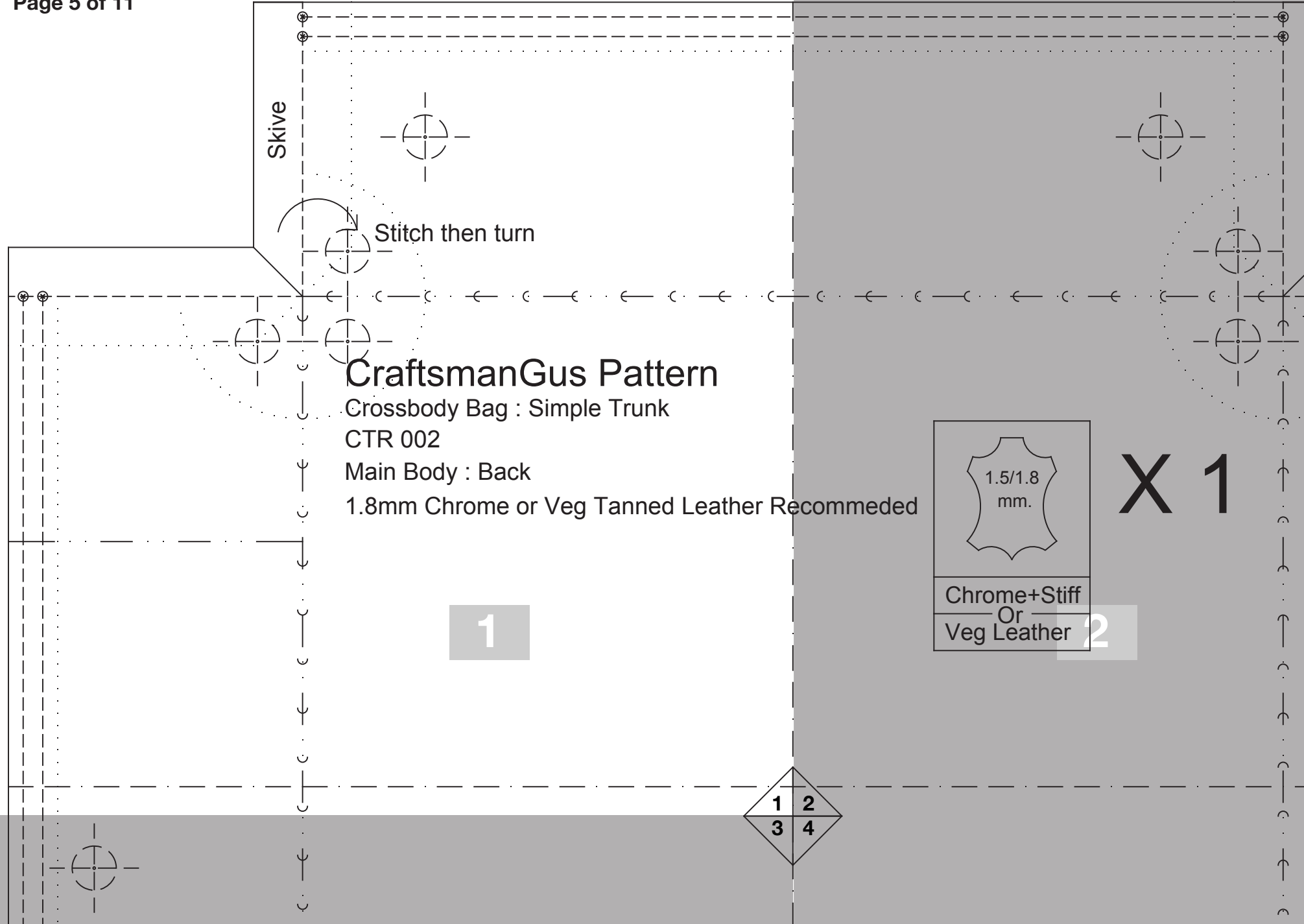

CraftsmanGus Pattern

Crossbody Bag : Simple Trunk

CTR 002

Main Body : Back

1.8mm Chrome or Veg Tanned Leather Recommended

1

 1.5/1.8 mm.
Chrome+Stiff Or Veg Leather

X 1

2

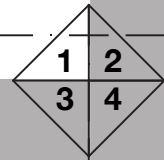

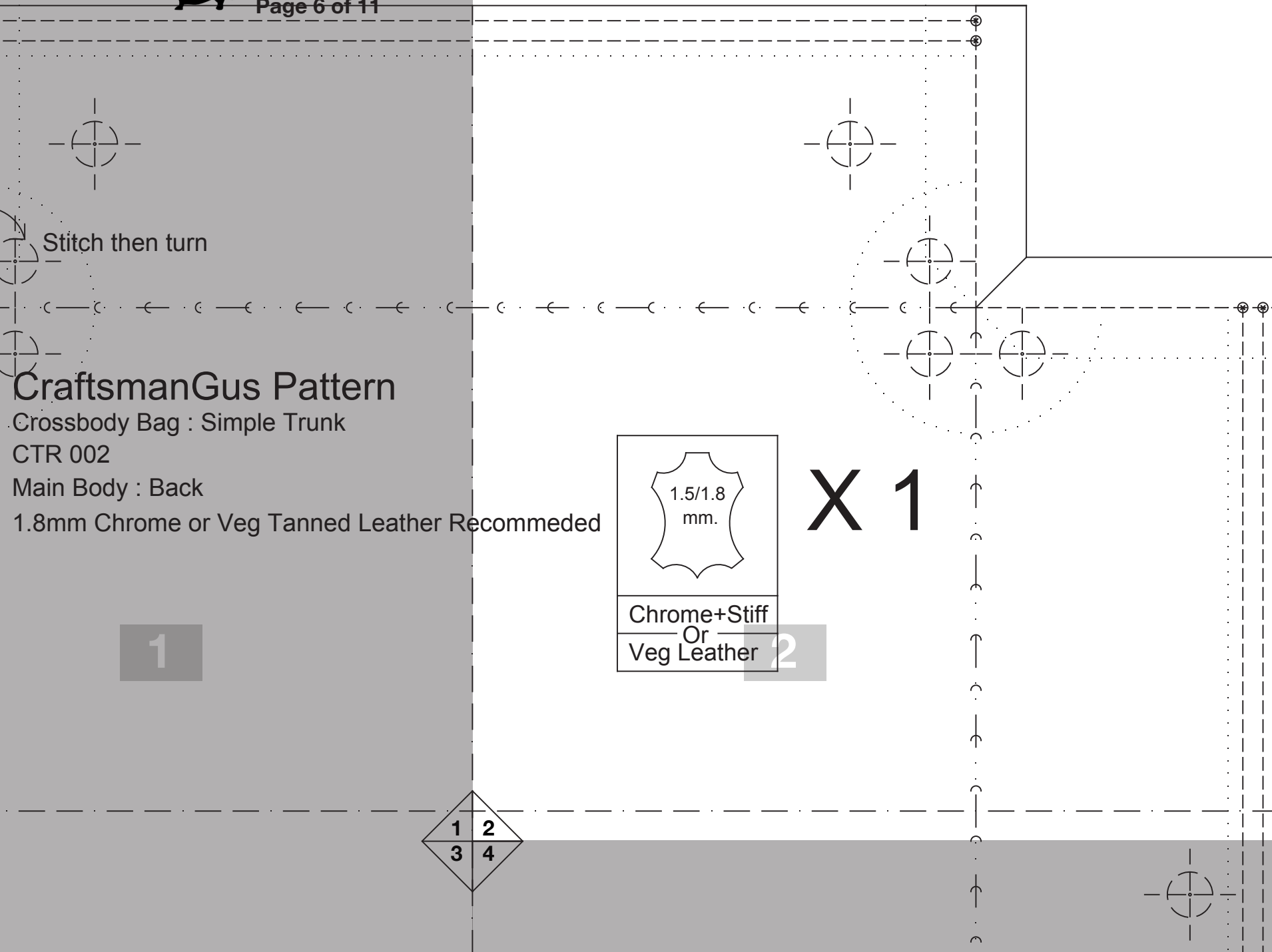

Stitch then turn

CraftsmanGus Pattern

Crossbody Bag : Simple Trunk

CTR 002

Main Body : Back

1.8mm Chrome or Veg Tanned Leather Recommended

 1.5/1.8 mm.	X 1
Chrome+Stiff Or Veg Leather	

1

2

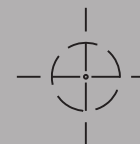
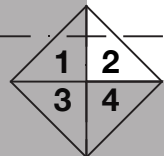

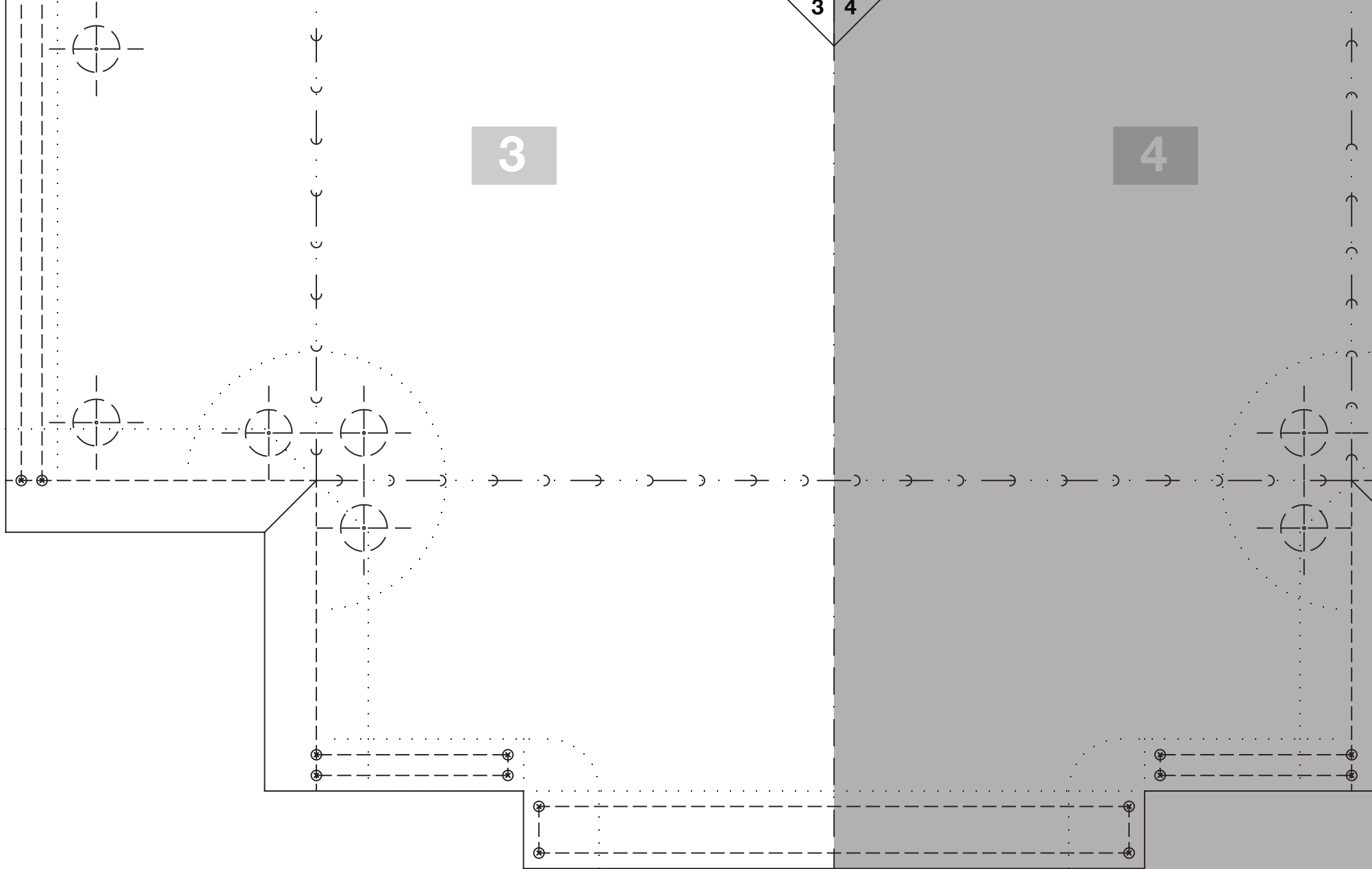
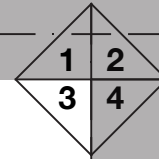

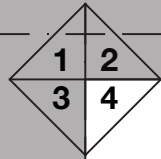

3

4

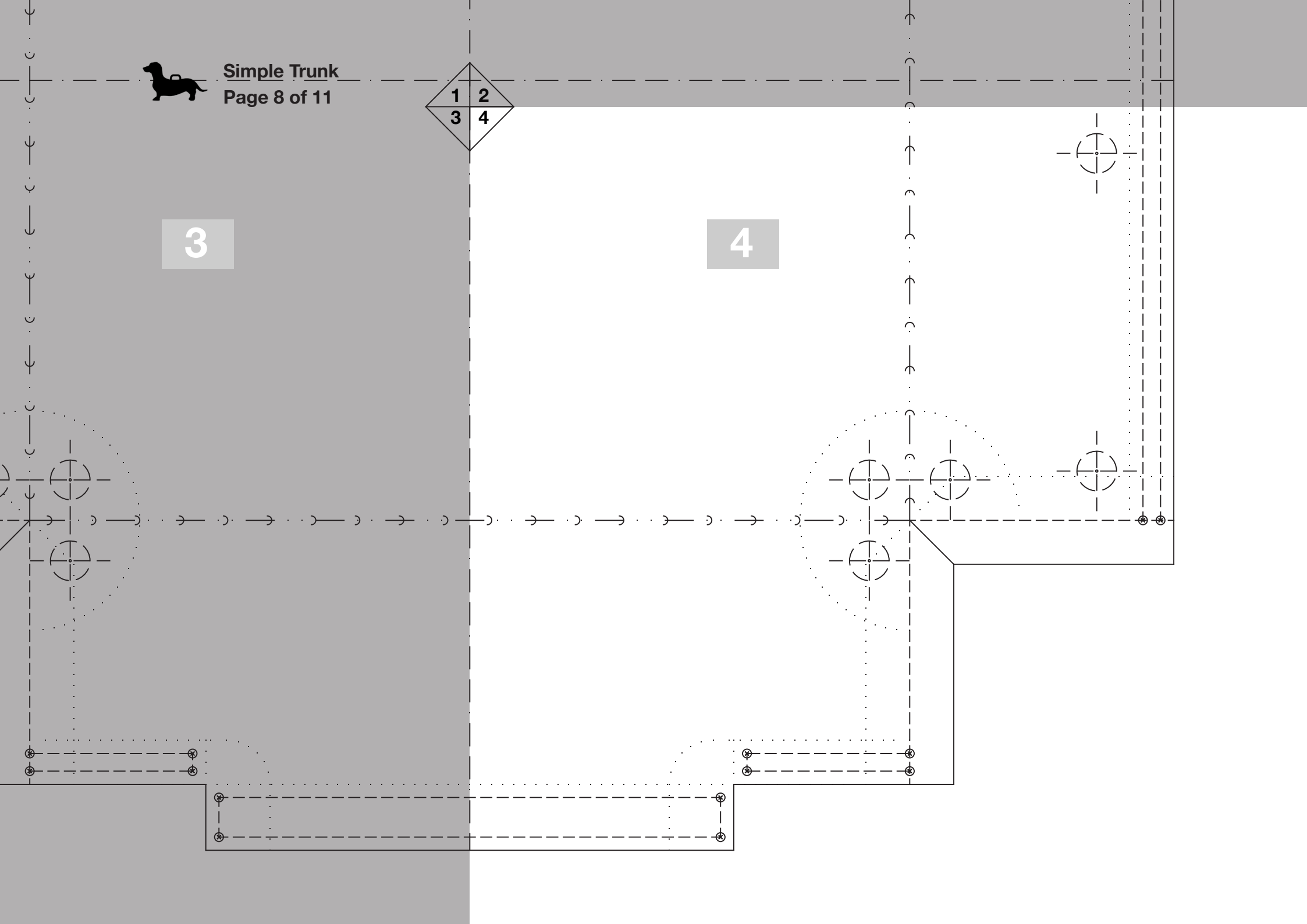

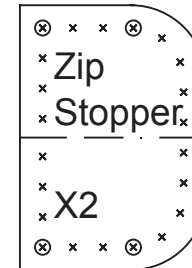

Cut the "Opening/Zipper Strap" to 1 cm x 71.6 cm

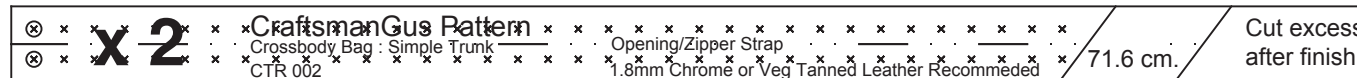



BELT STRAP

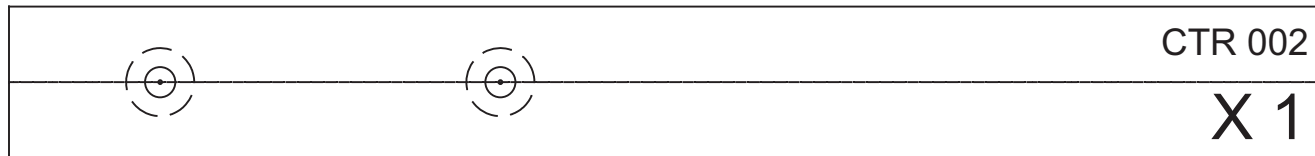
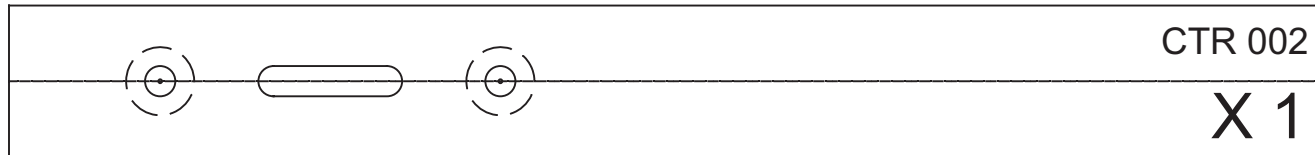

Tile

