

CREATIVE AWL

leather patterns

ARCHERS QUIVER

PREPARED BY:

Patryk Ku,
www.CreativeAwl.com



**PLEASE
READ!**

If it wasn't for your support, this pattern wouldn't have come into being, thanks! If you already post pictures of your bag in the social media, I would be invariably glad if you would mention the author. I also encourage you to share your work on our facebook group.

All rights reserved. No content may be shared or reproduced. If you would like to share it, please recommend our facebook group or <https://www.creativeawl.com>

Thank you and have fun!

Patryk

LET'S GO:

PRINT THE PATTERN

01

- Open your pattern in Adobe Acrobat Reader. Set up options of your printer on A4 paper with 0 margins (if needed).
- Every page has a measure - check does it fit.
- Every printed page **MUST HAVE** a border around! If doesn't - move paper left/ right and print again

02

VIDEO TUTORIAL:

<https://youtu.be/OcK6CmDu7N4>

Cutting patterns:

https://youtu.be/2TNUI_TIk64

03

GIVE A SMILE TO OTHER PEOPLE!

Give a ready product to you family or freind. Give them a smile :)))

Also Check www.CreativeAwl.com for more patterns

04

JOIN OUR FB GROUP

Go there to share your work. Also get more DIY&ideas. We will support you & answer all questions.

<https://www.facebook.com/groups/CreativeAwlPatterns>

QUIVER CAN BE HUNG:

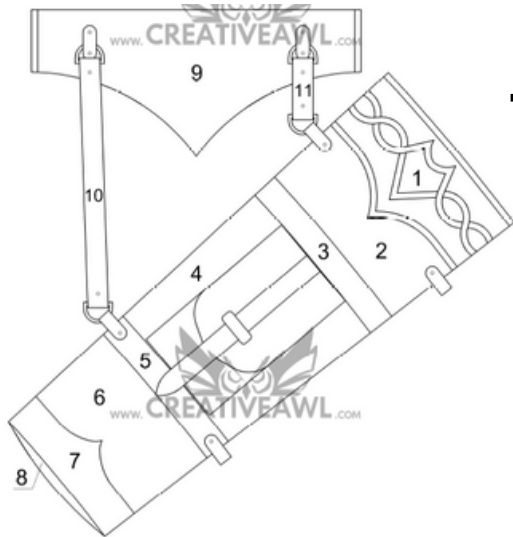

- ON THE STRAPS ATTACHED TO THE HIP COVER

* IF YOU WANT TO WEAR IT WITH DIFFERENT ANGLE - SHORTEN OR LENGTHEN THE LONGER STRAP

* IMAGE SHOWS THE VERSION FOR RIGHT HANDED , - CHANGE THE STRAP PLACEMENT FOR LEFT-HANDED

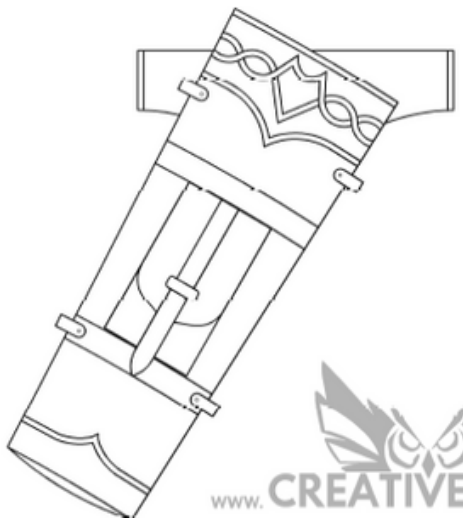

- RIVETED ON THE HIP IN 3 DIFFERENT ANGLES FOR LEFT OR RIGHT HANDED

* RIGHT-HANDED WEAR QUIVER ON THEIR RIGHT SIDE



- ON THE BACK WITH 2 STRAPS

* ONE CARABINEER ATTACHED TO THE DOWN D-RING, SECOND TO THE ONE ONE 6 EYELETS ON TOP

* RIGHTHANDED HAVE THE QUIVER HOLE ON THEIR RIGHT SIDE

YOU NEED

TOOLS

- sharp knife
- 1,2-1,5mm hole puncher or pricking irons or awl
- hammer
- 2 needles
- paper tape
- a home printer
- eyelets setter or press

MATERIALS

- 0,45 sq meter of 5oz (2mm) leather
- 4 x 20mm d-rings for quiver
- 2 x 20mm d-rings for hip cover
- *2 x 20mm carabineers for hip straps
- *2 x 20mm carabineers for shoulder strap
- 6 x 6-8mm eyelets or 6 rivets
- about 31.5" (80cm) thong



SHARE YOUR WORK

<https://www.facebook.com/groups/CreativeAwlPatterns>

If you got ANY problem,- don't be shy to ask directly on Etsy or facebook

Leather quiver:

pages 1 - 22

- The number in the circle shows which holes are to be connected. Example: ①
- Numbers 1, 2, 3 (...) without a circle indicate where the piece lies in the overview drawing.

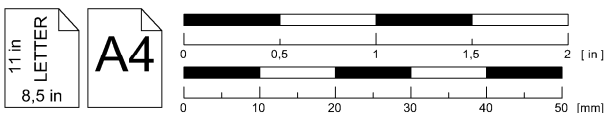
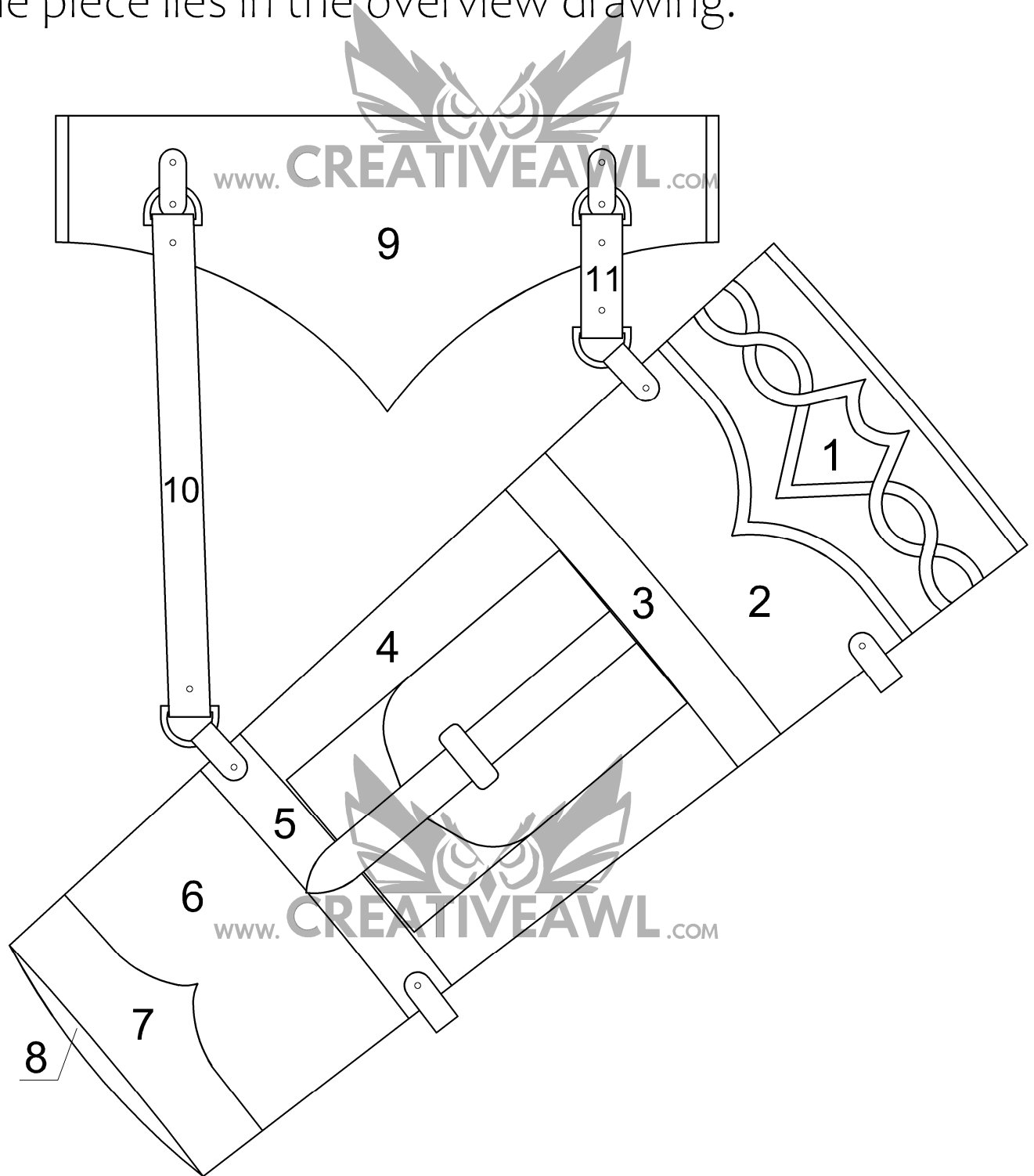

Sketch drawing

Leather needed for a quiver:
550 mm (22 in)

about 0,45 m²

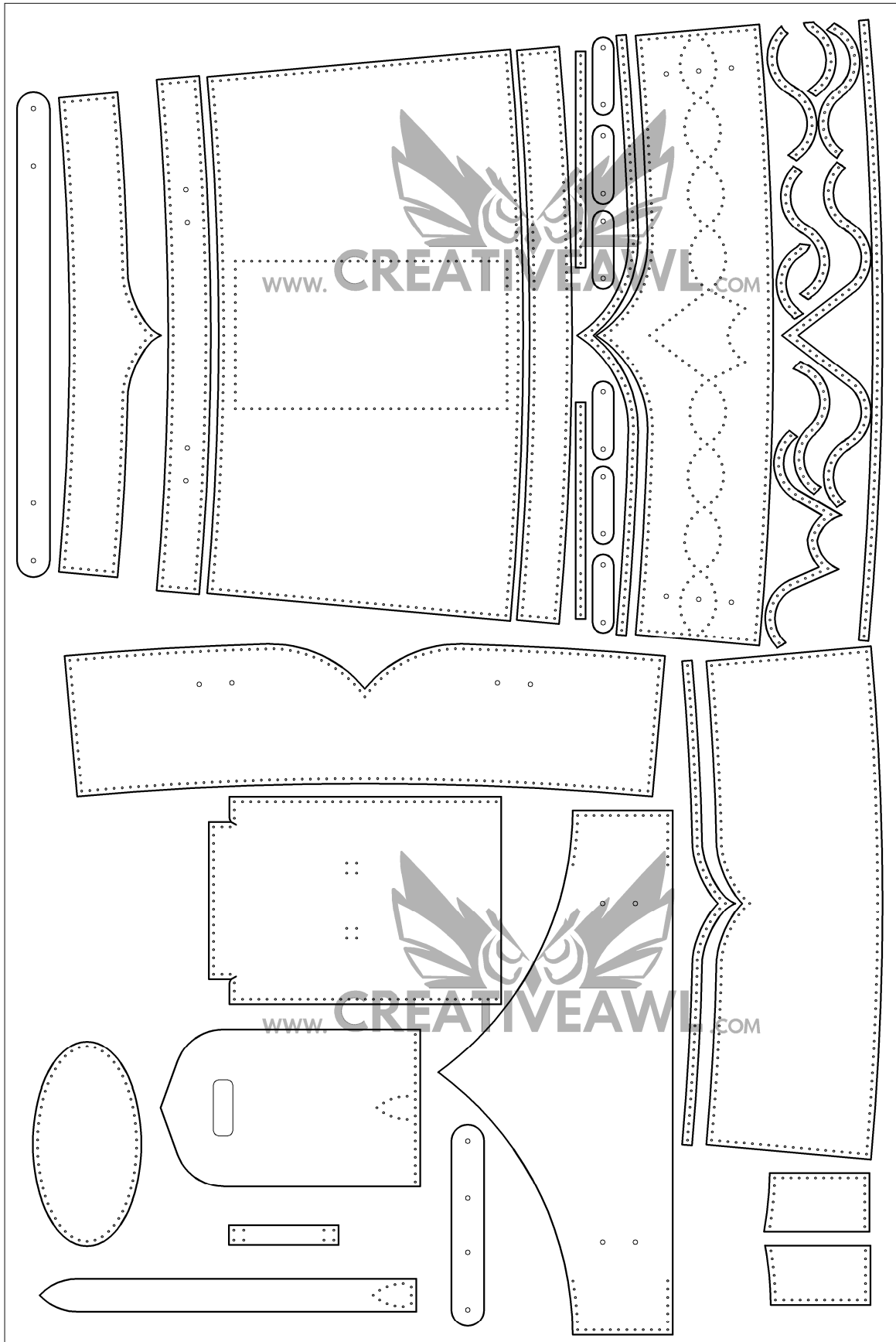

820 mm (32.8 in)

Sketch drawing
Bill of materials

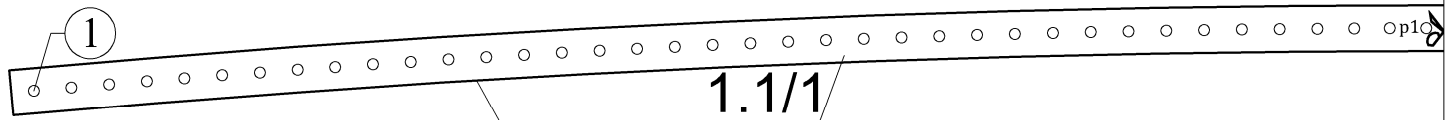

1.1/1

if you want to use a separator for arrows, sew this strip together with the separator at the end

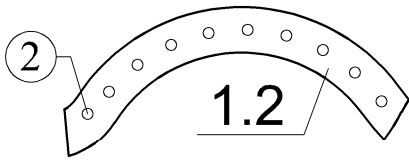

1.2

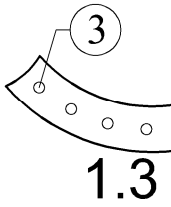

1.3

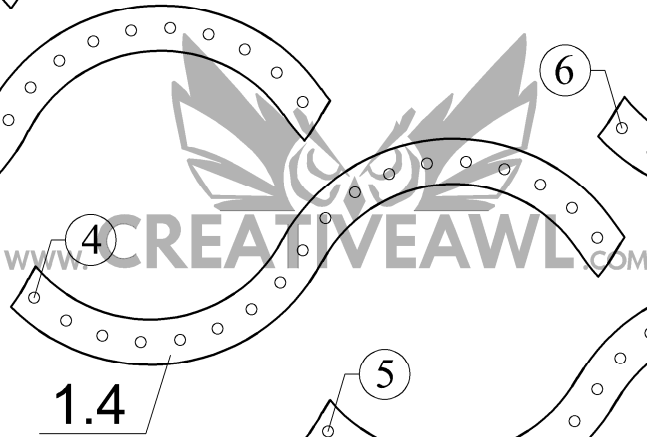

1.4

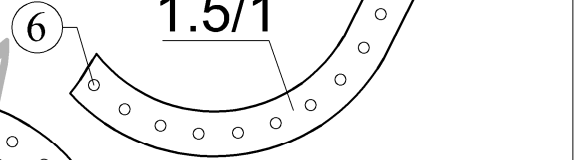

1.5/1

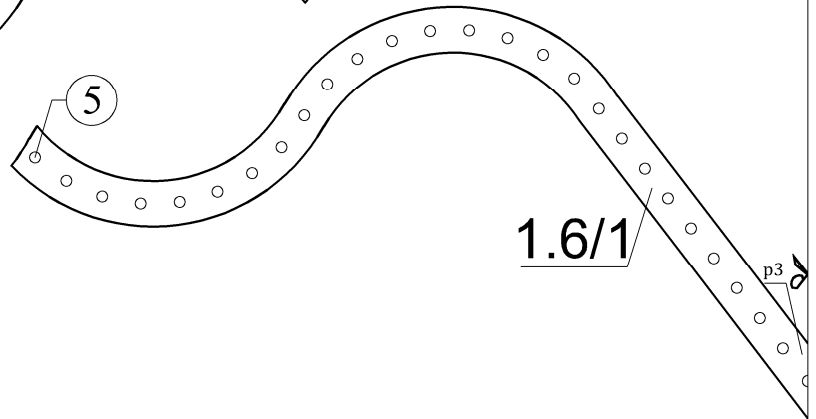

1.6/1

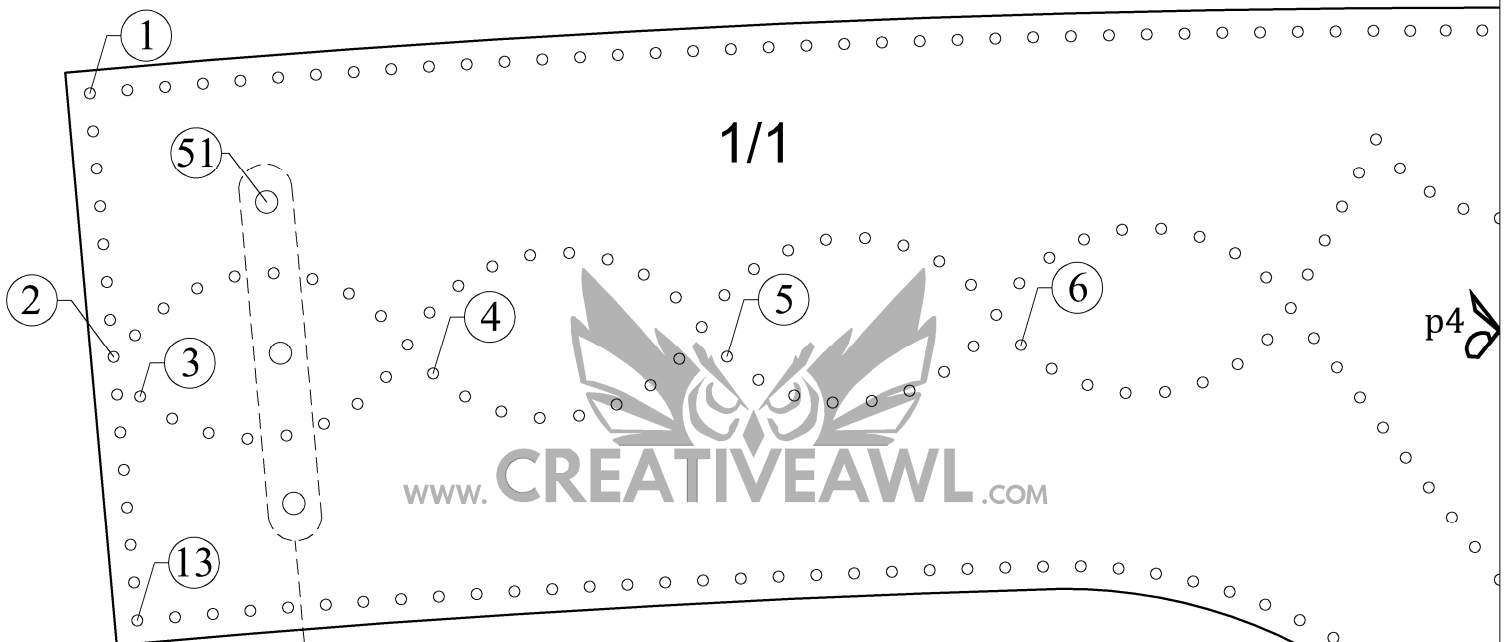

1/1

These holes are an option to mount the quiver rigidly to the belt, or Ø8 mm holes the strap holding the arrows, or Ø8 mm holes for attaching the handle to the back

11 in
LETTER
8,5 in

A4

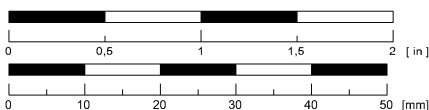

Quiver

3

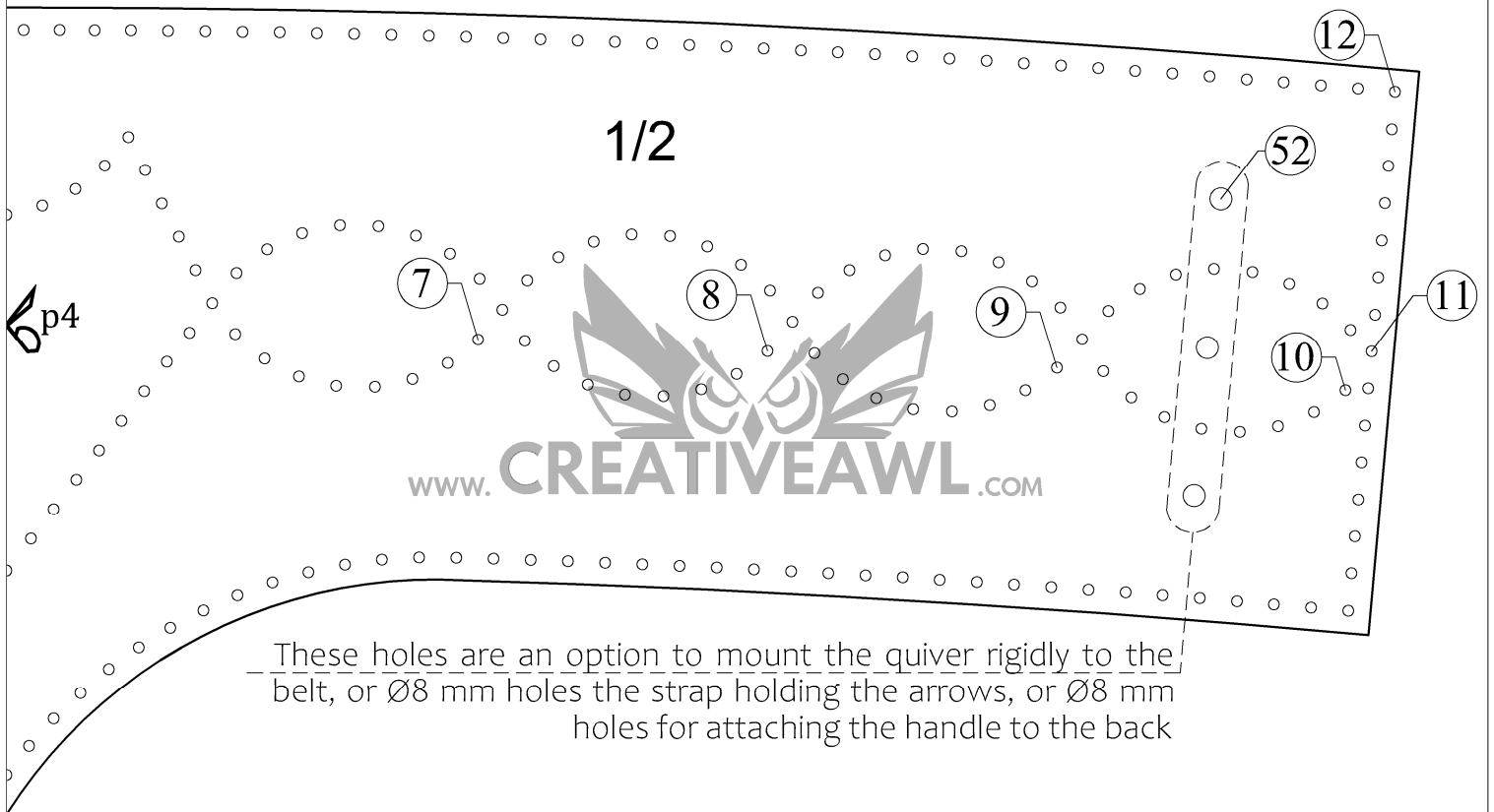
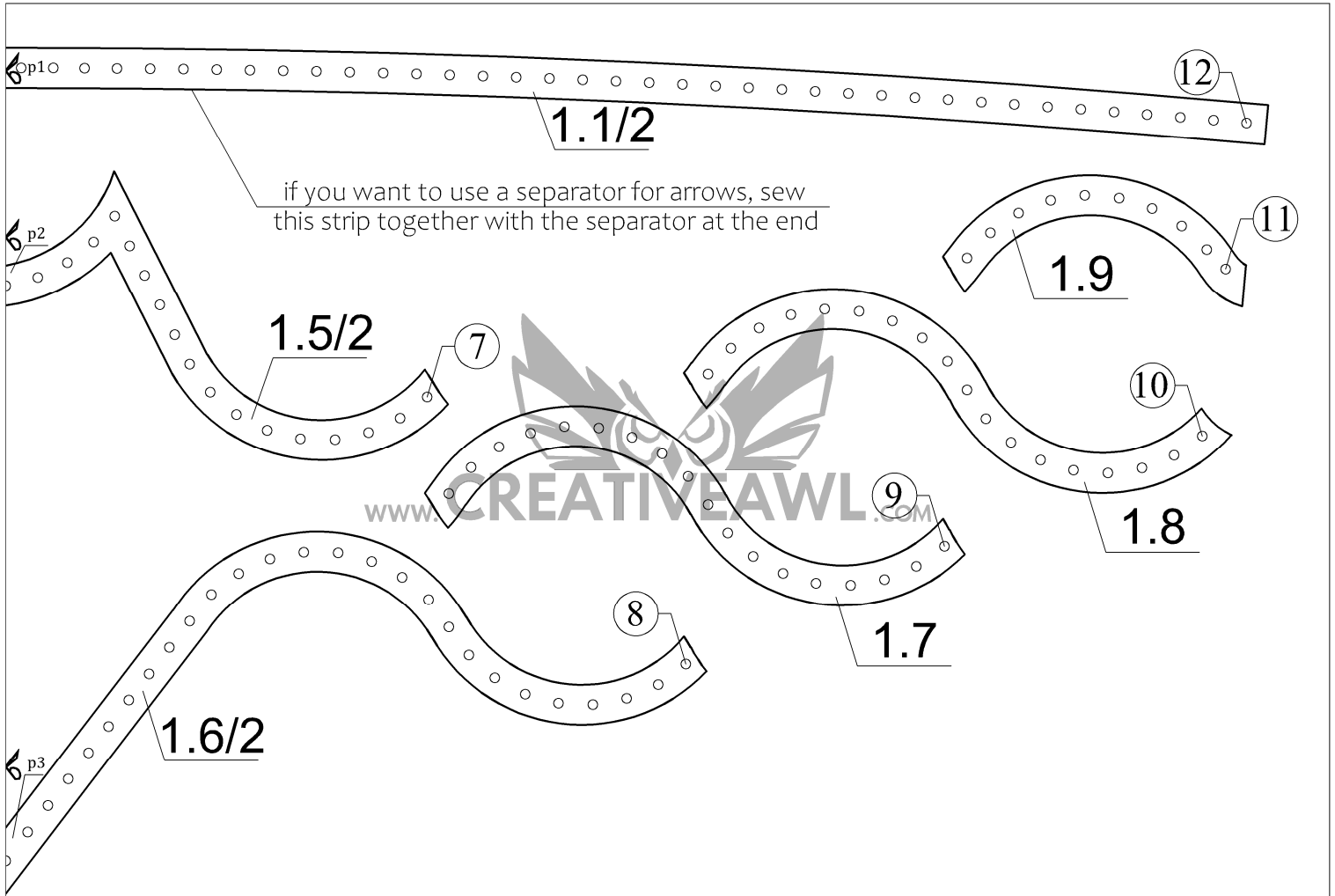

11 in
LETTER
8,5 in

A4

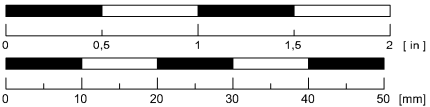

Quiver

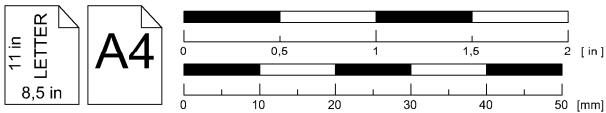
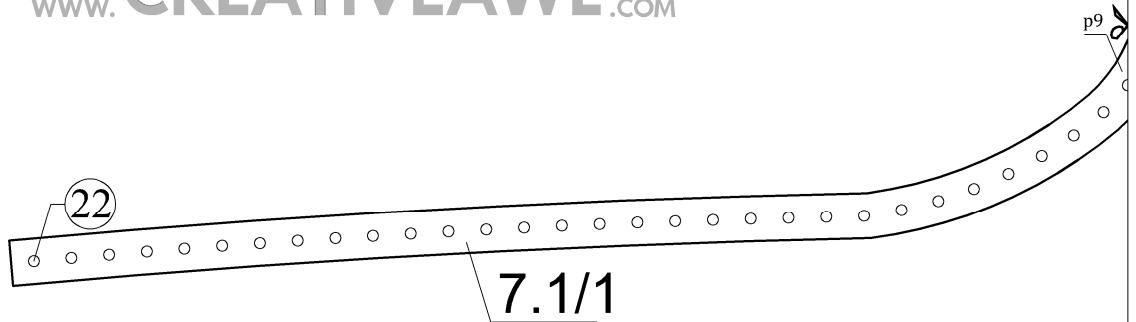
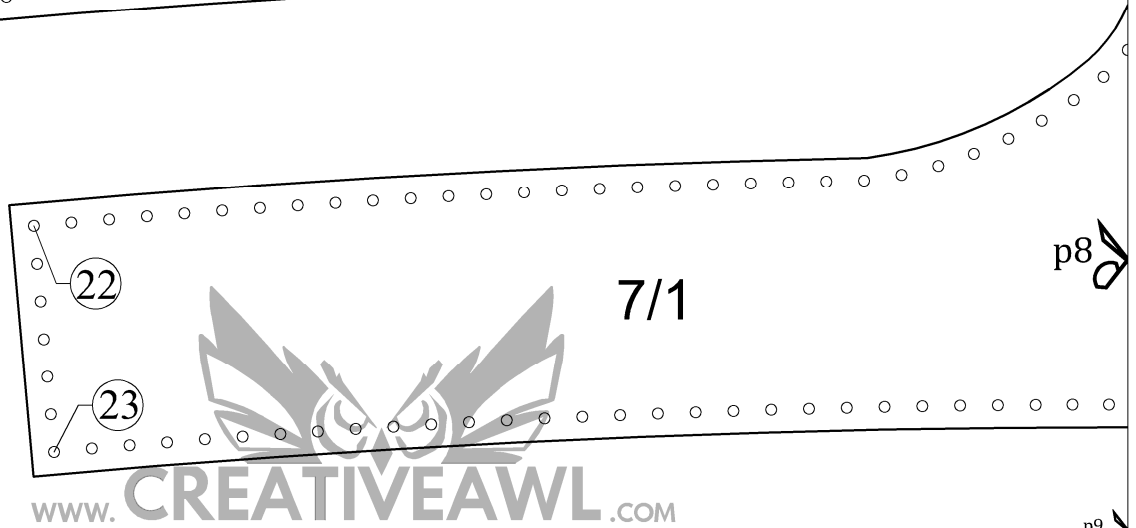
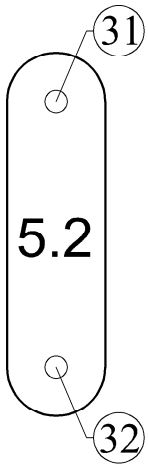
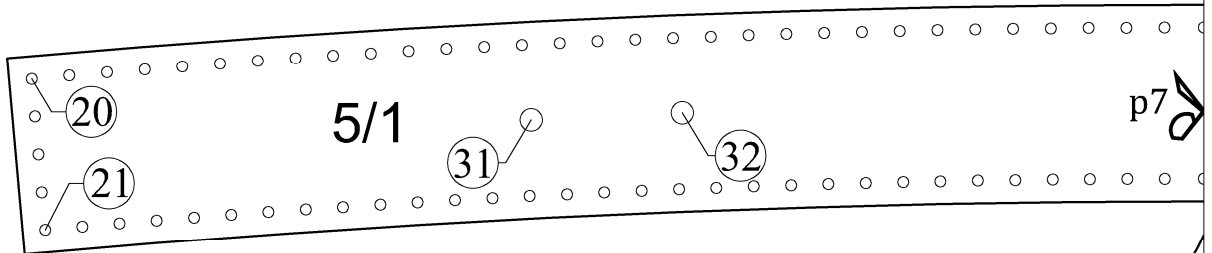
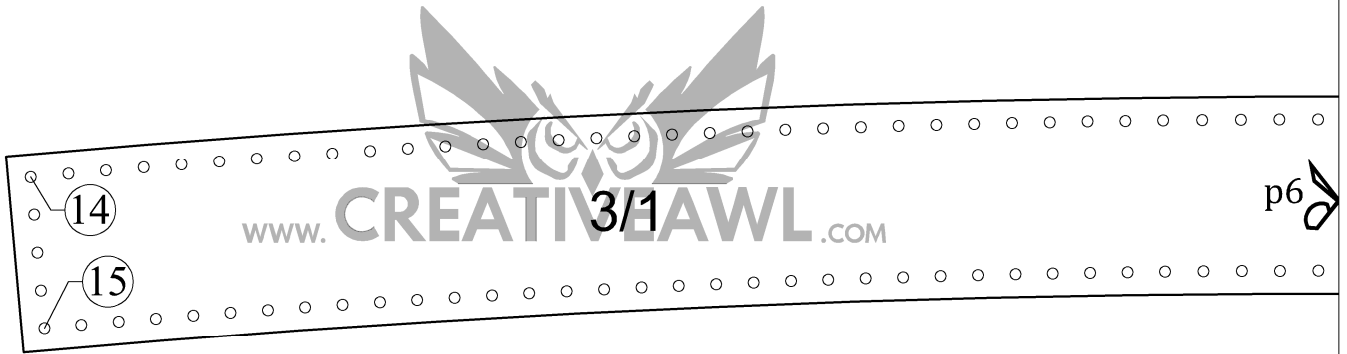
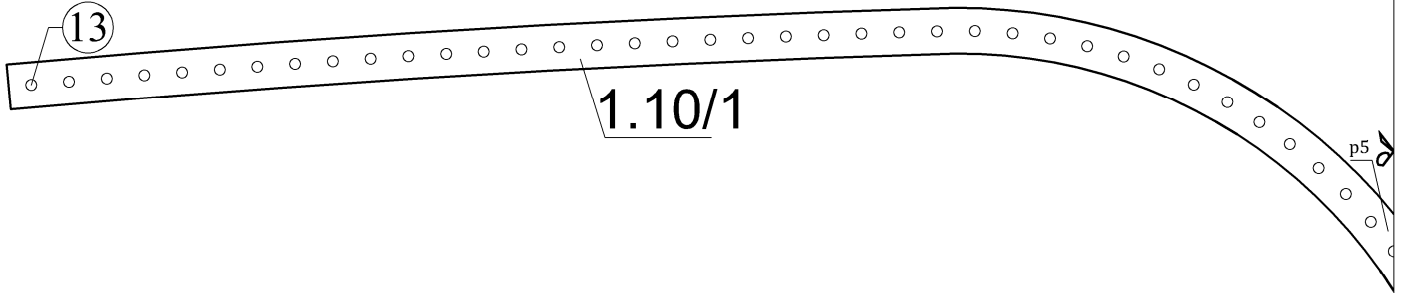

Quiver

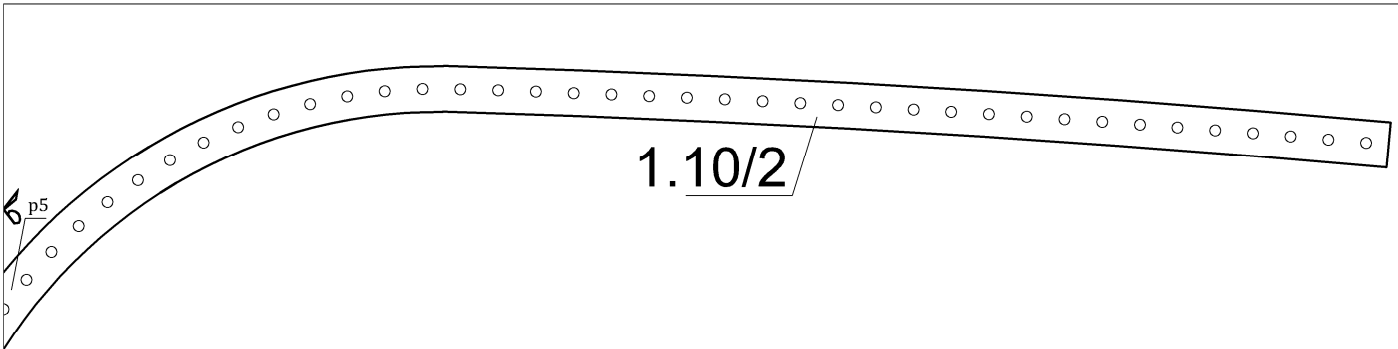

1.10/2

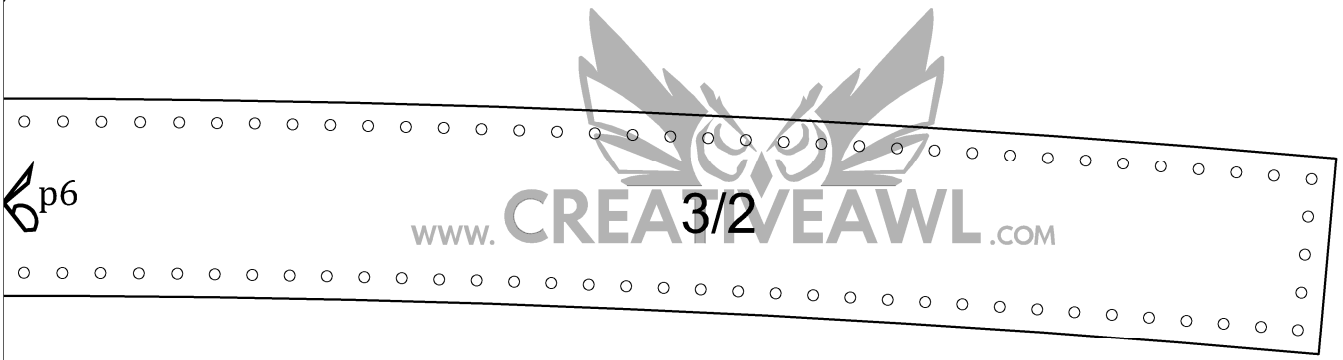

www.CREATIVEAWL.COM

3/2

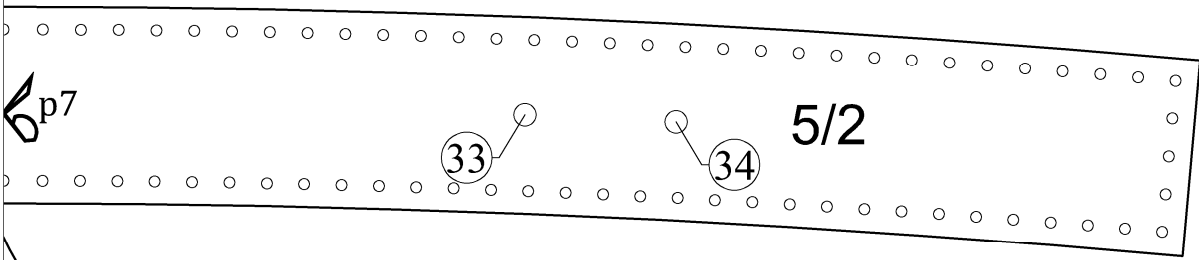

5/2

33

34

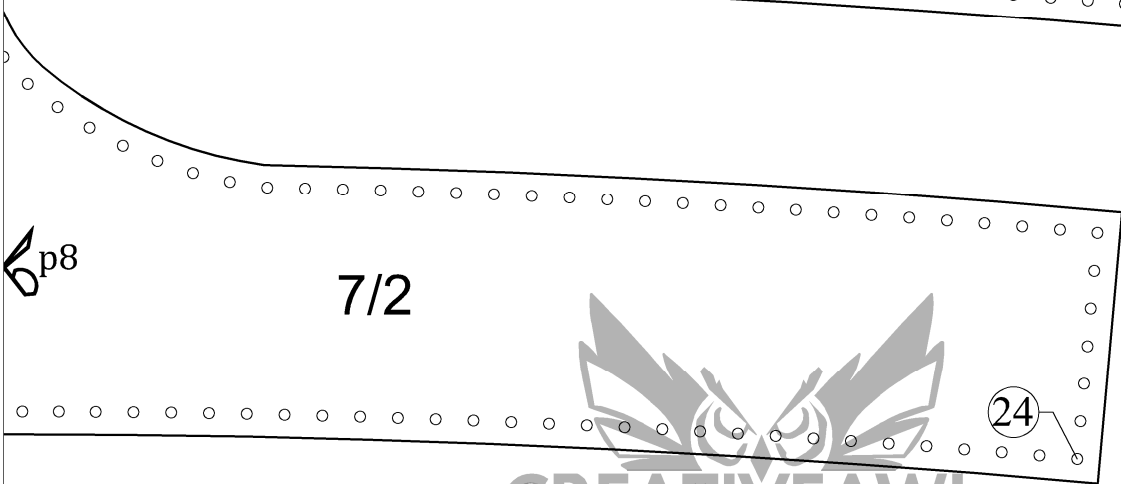

7/2

24

www.CREATIVEAWL.COM

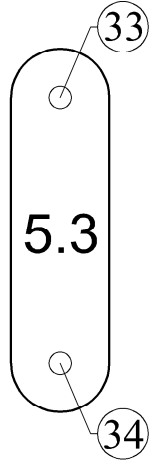

5.3

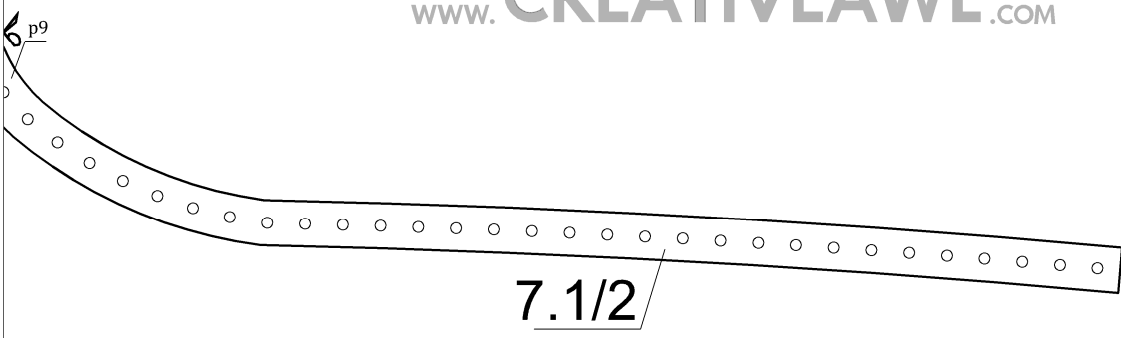

7.1/2

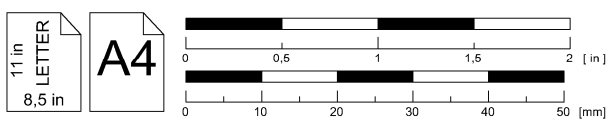

Quiver

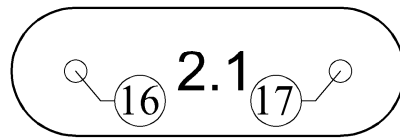

11 in
LETTER
8,5 in

A4

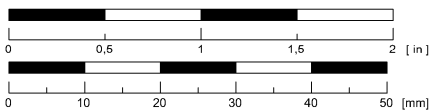

Quiver

7

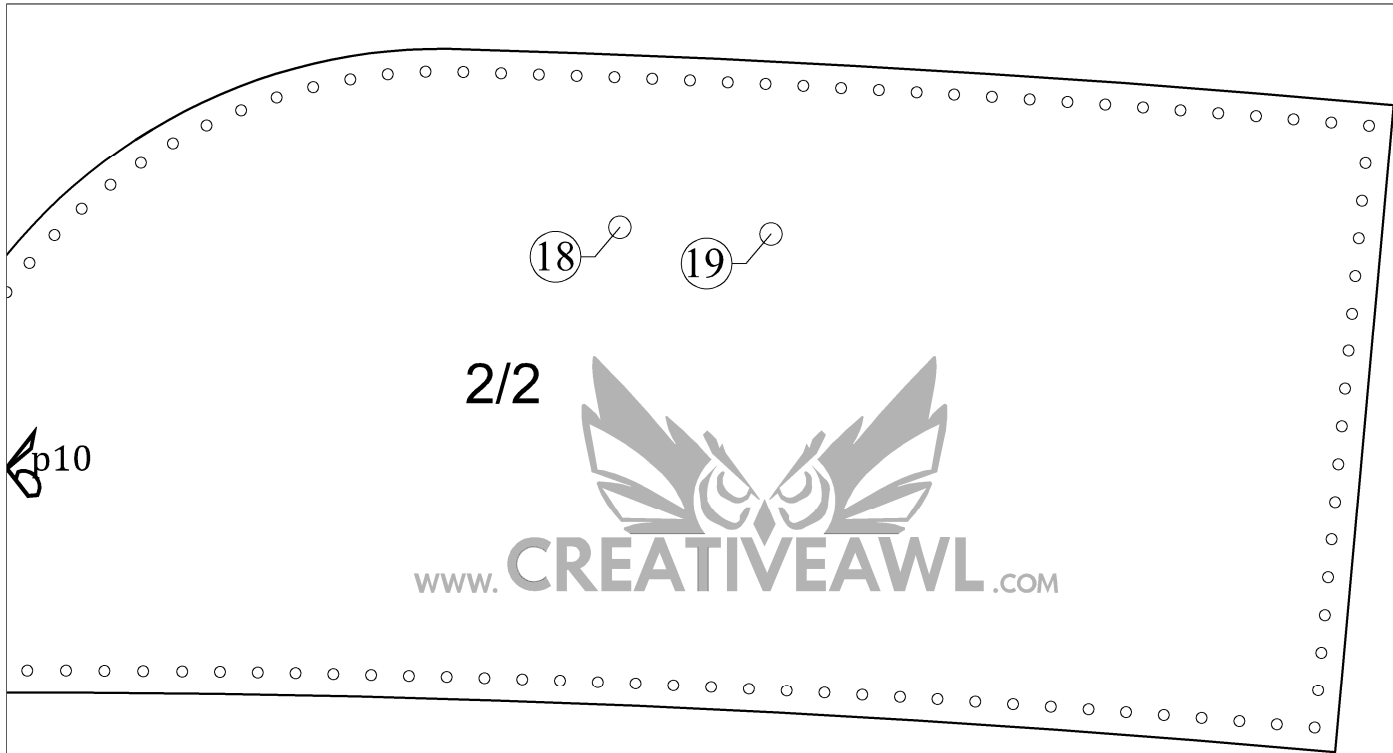

p10

2/2

18 19

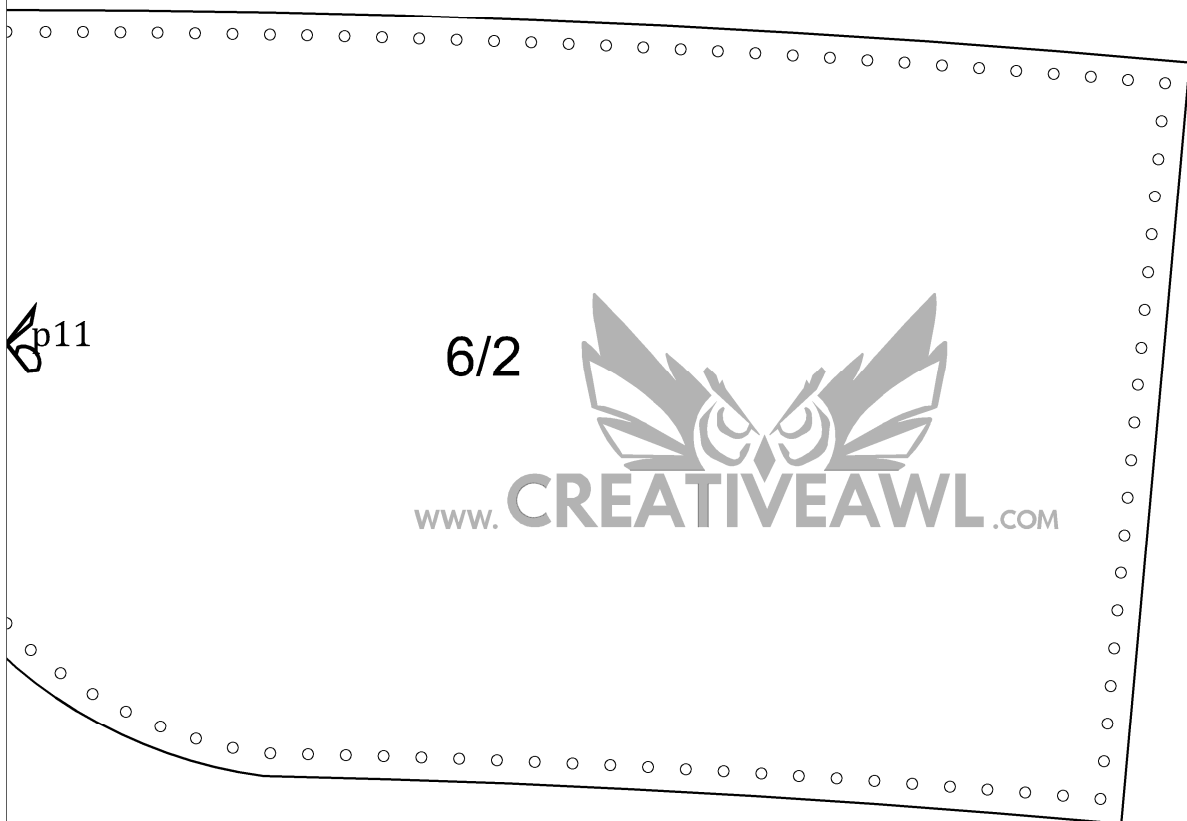
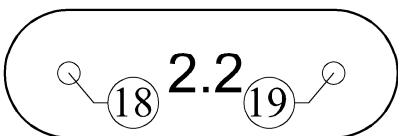

p11

6/2

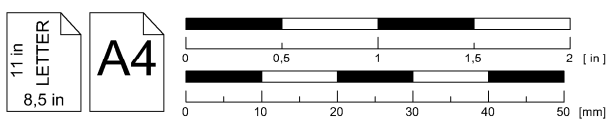

Quiver



37

37

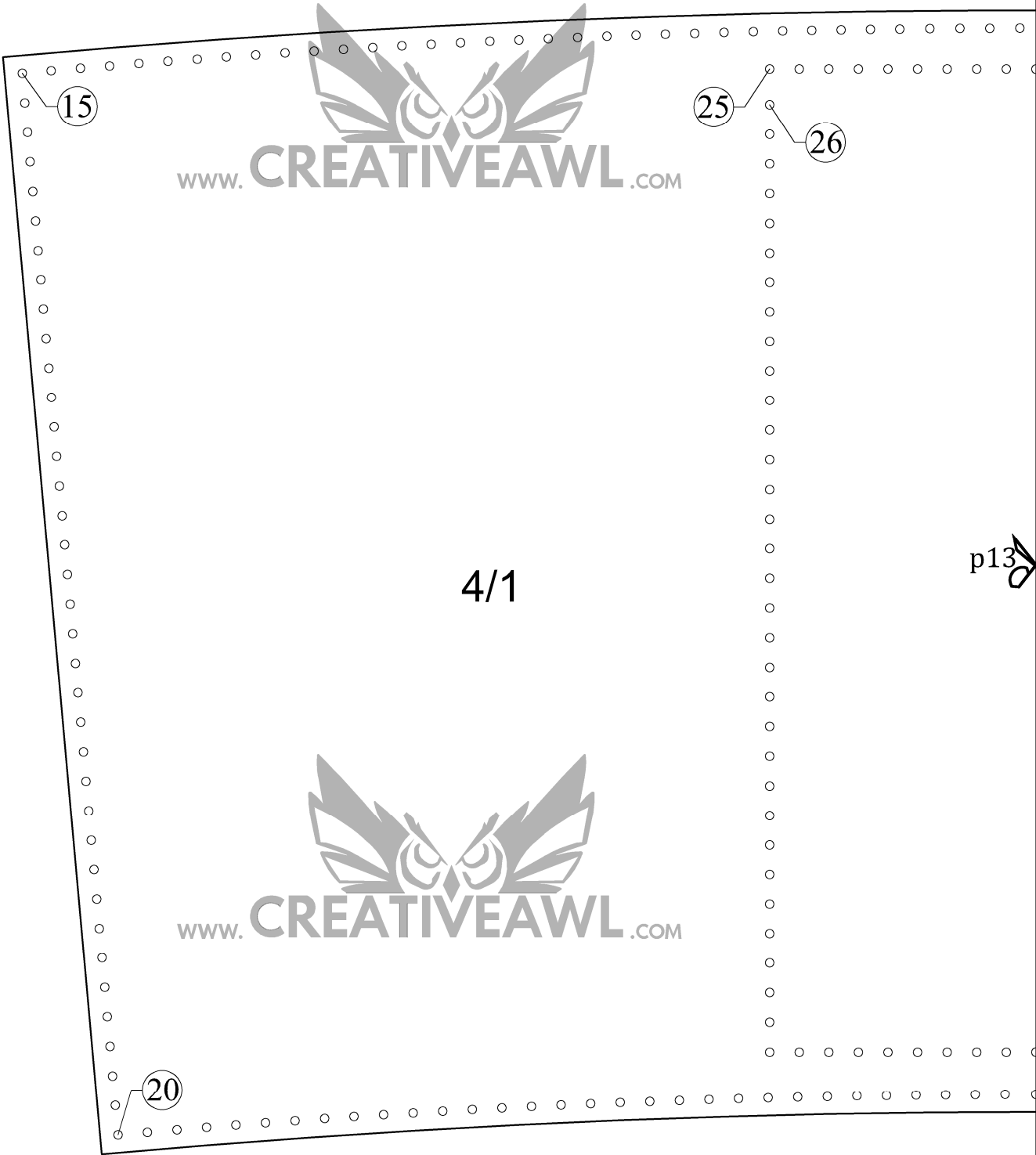

www.CREATIVEAWL.COM

www.CREATIVEAWL.COM

4/1

11 in
LETTER
8,5 in

A4

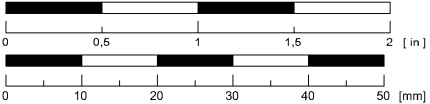

Quiver

p12

10/2

38

38

p13

4/2

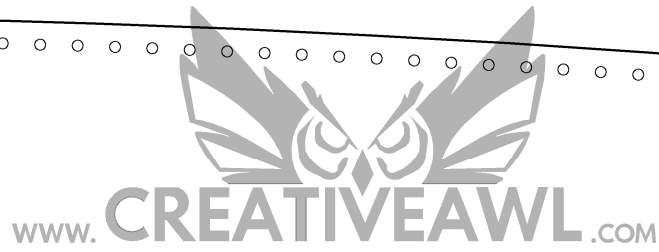

11 in
LETTER
8,5 in

A4

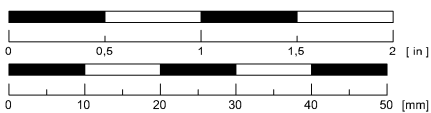

Quiver



4.1

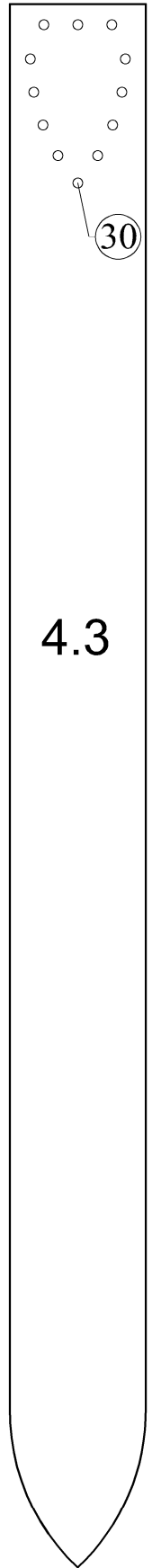

4.3

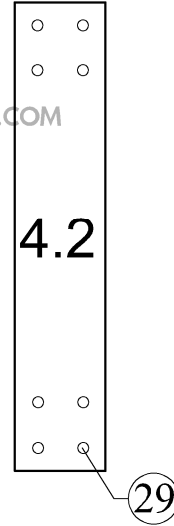

4.2



8

11 in
LETTER
8,5 in

A4

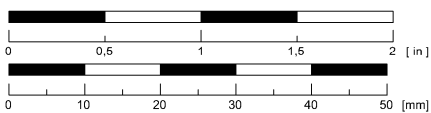

Quiver

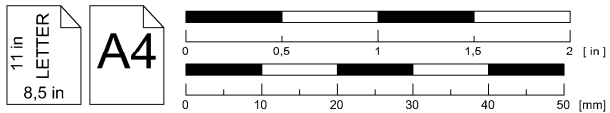
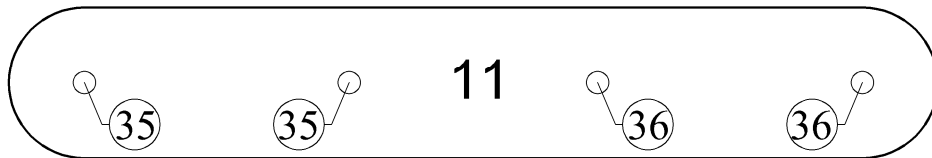

Quiver

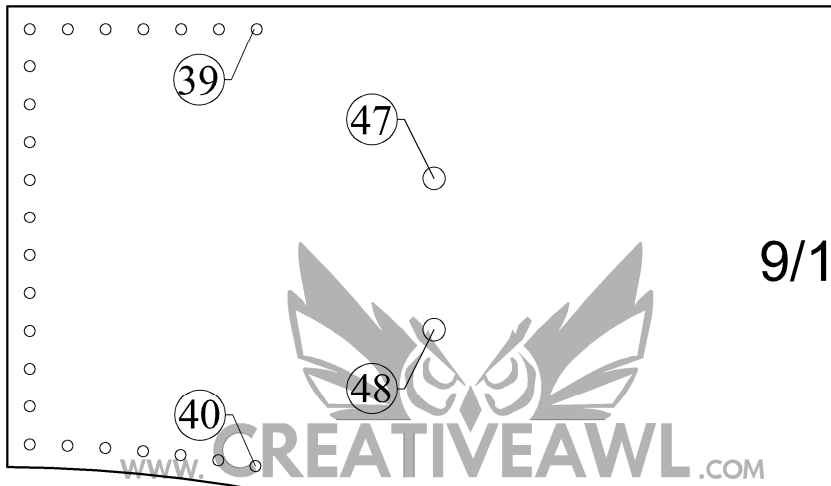

p14 

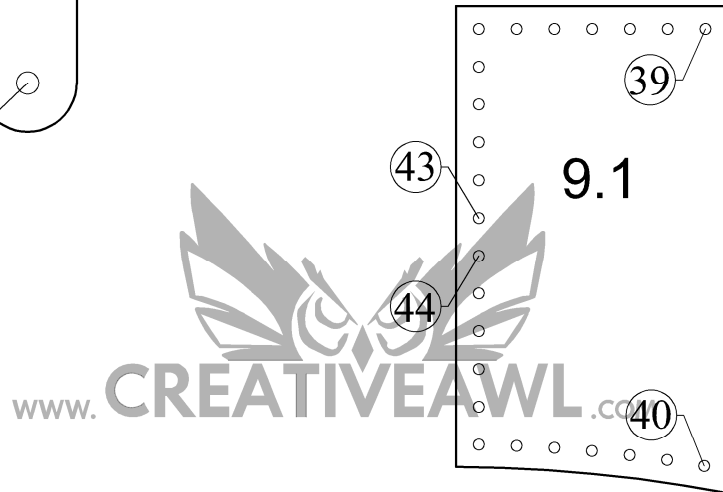
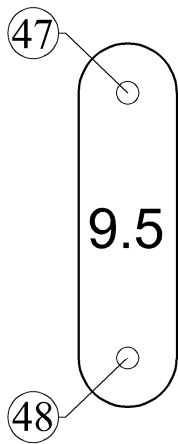

11 in
LETTER
8.5 in

A4

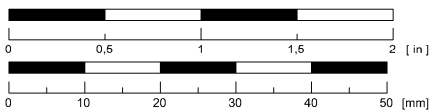

Quiver

p14

9/2

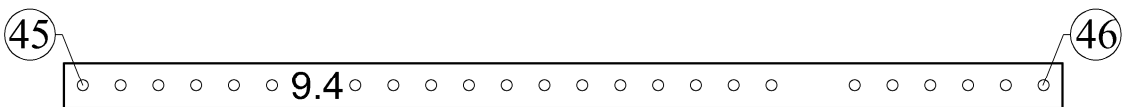
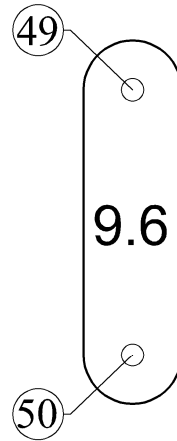
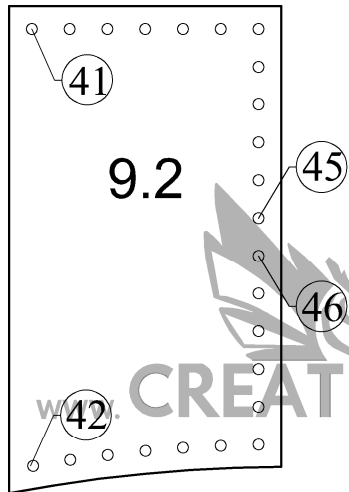

11 in
LETTER
8.5 in

A4

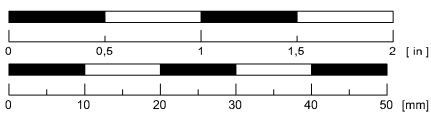

Quiver

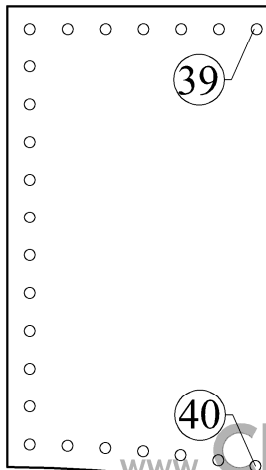

9/1

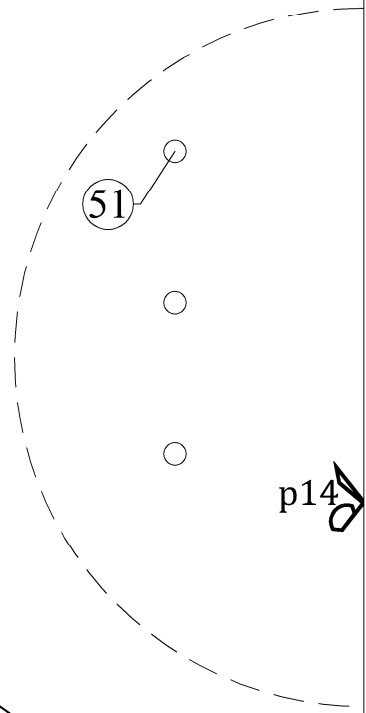

p14

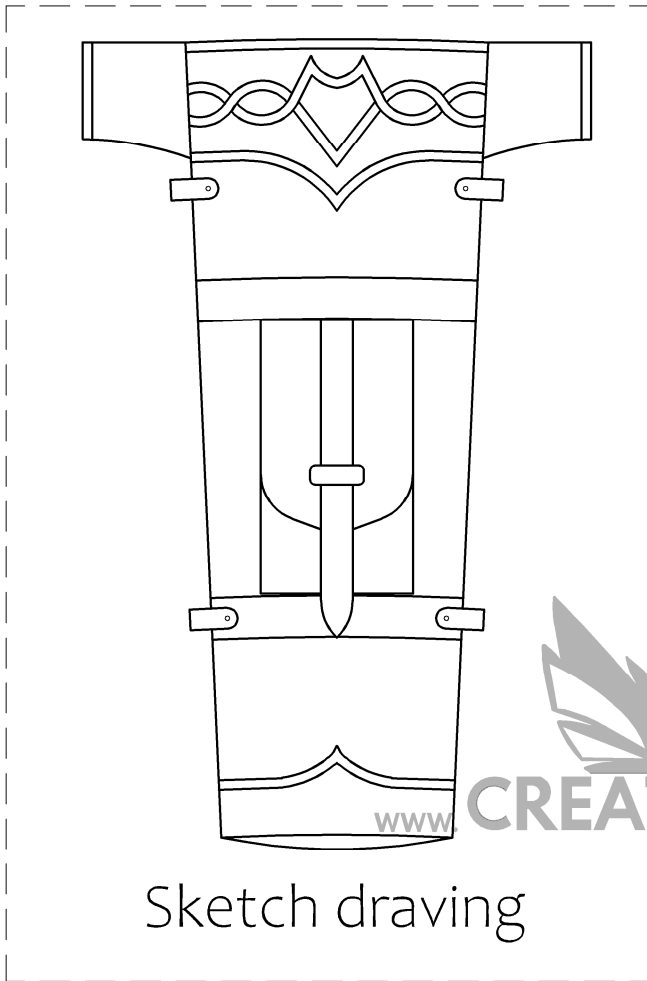

Sketch drawing

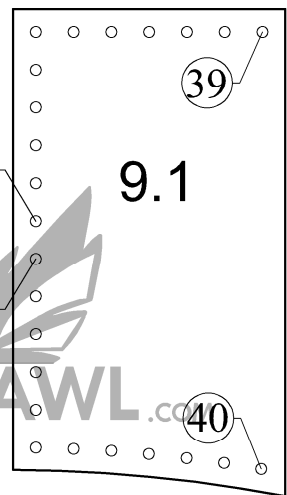

9.1

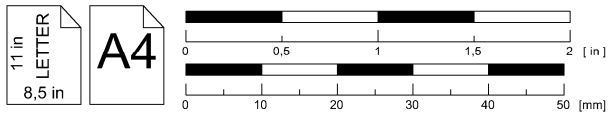
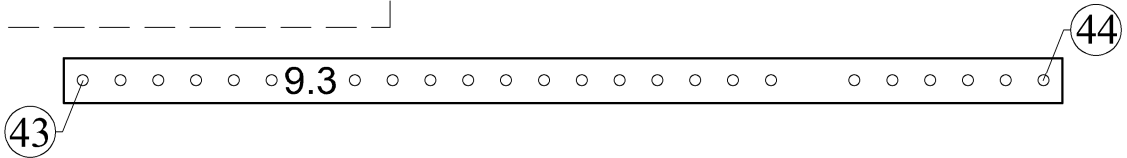

Quiver

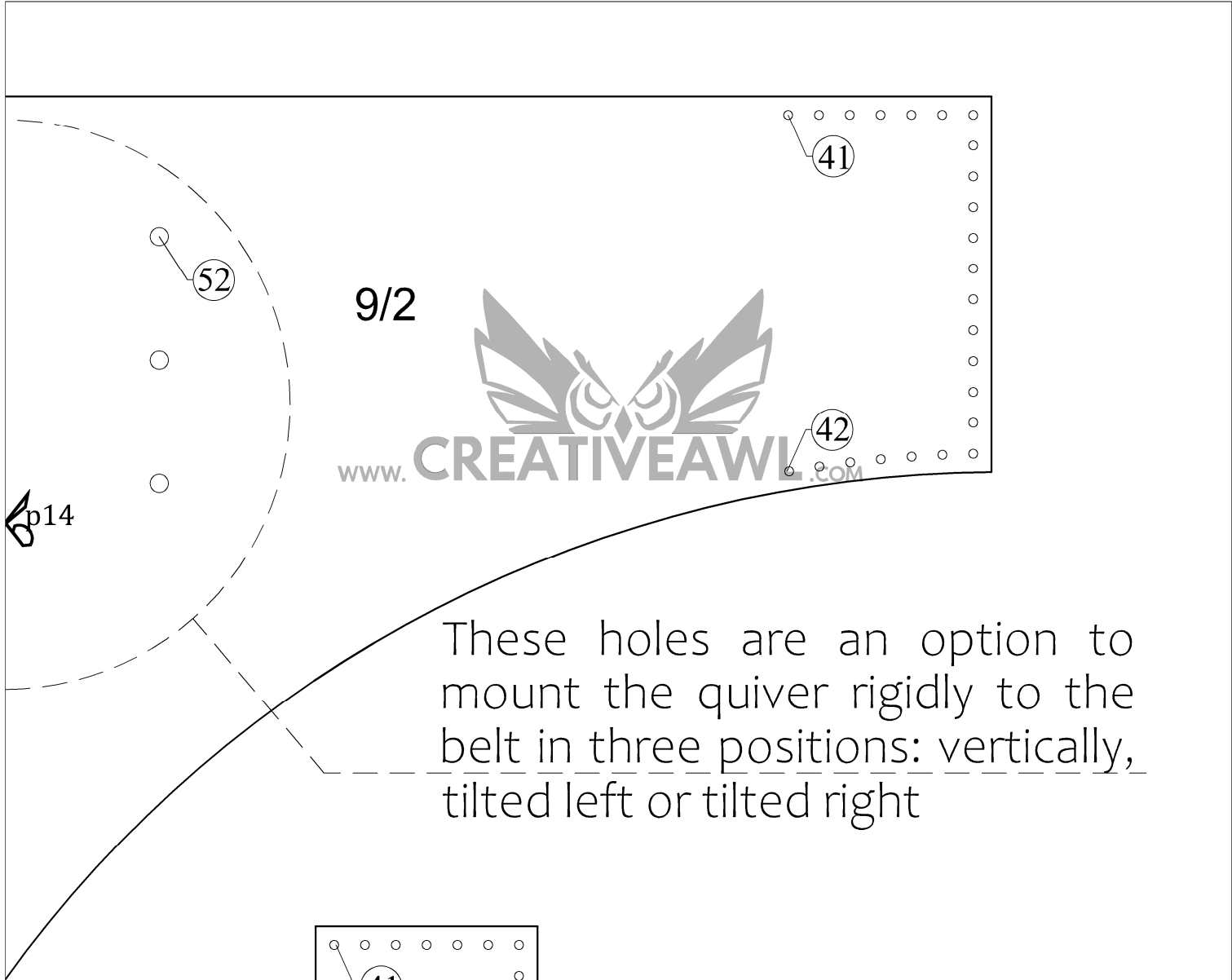

p14

9/2

www.CREATIVEAWL.COM

These holes are an option to mount the quiver rigidly to the belt in three positions: vertically, tilted left or tilted right

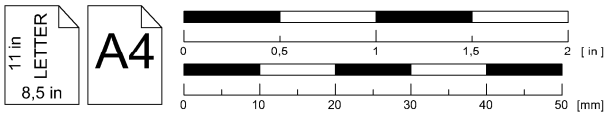
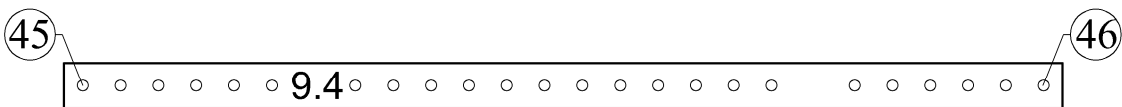
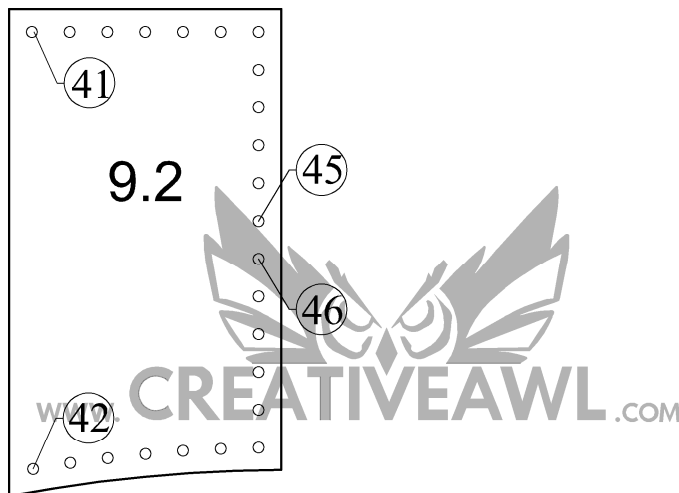

Quiver

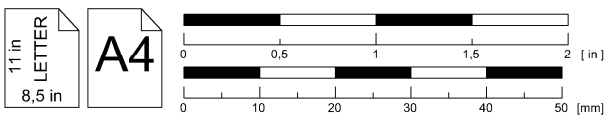
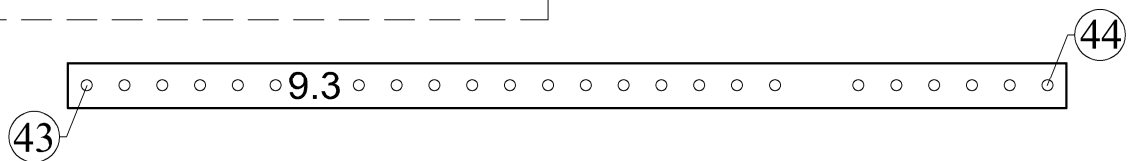
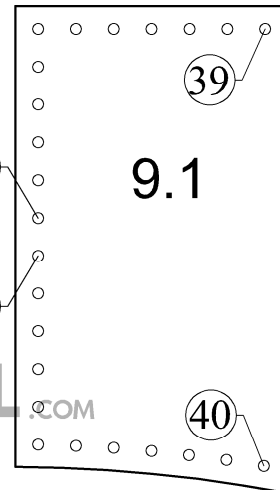
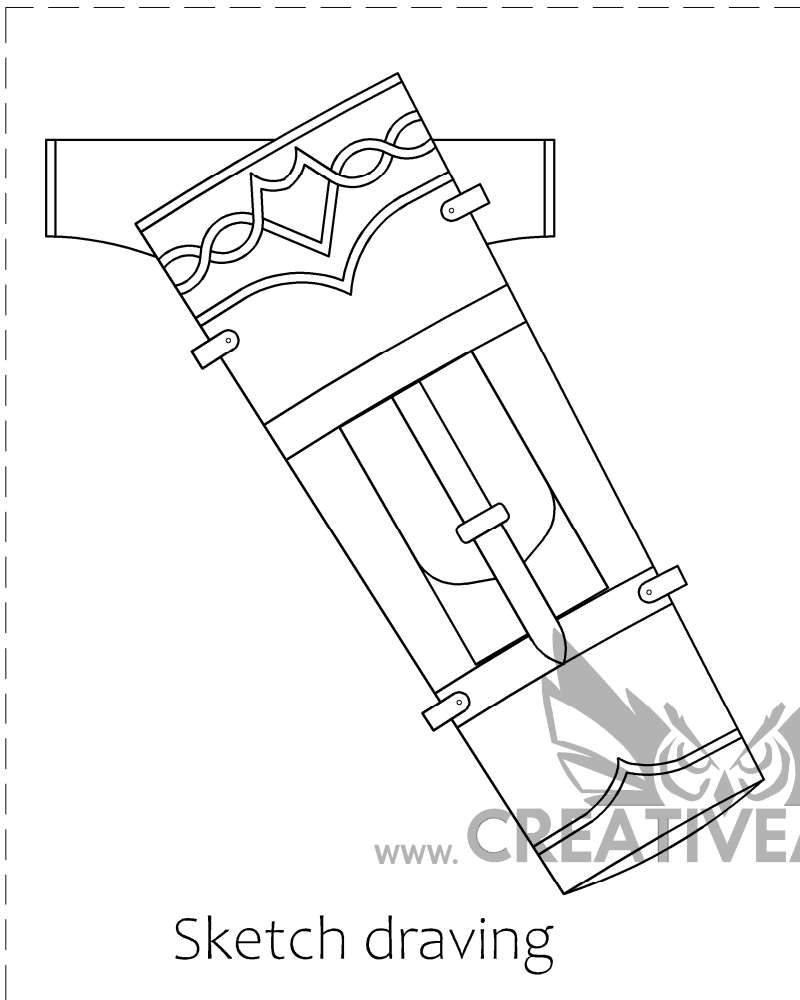
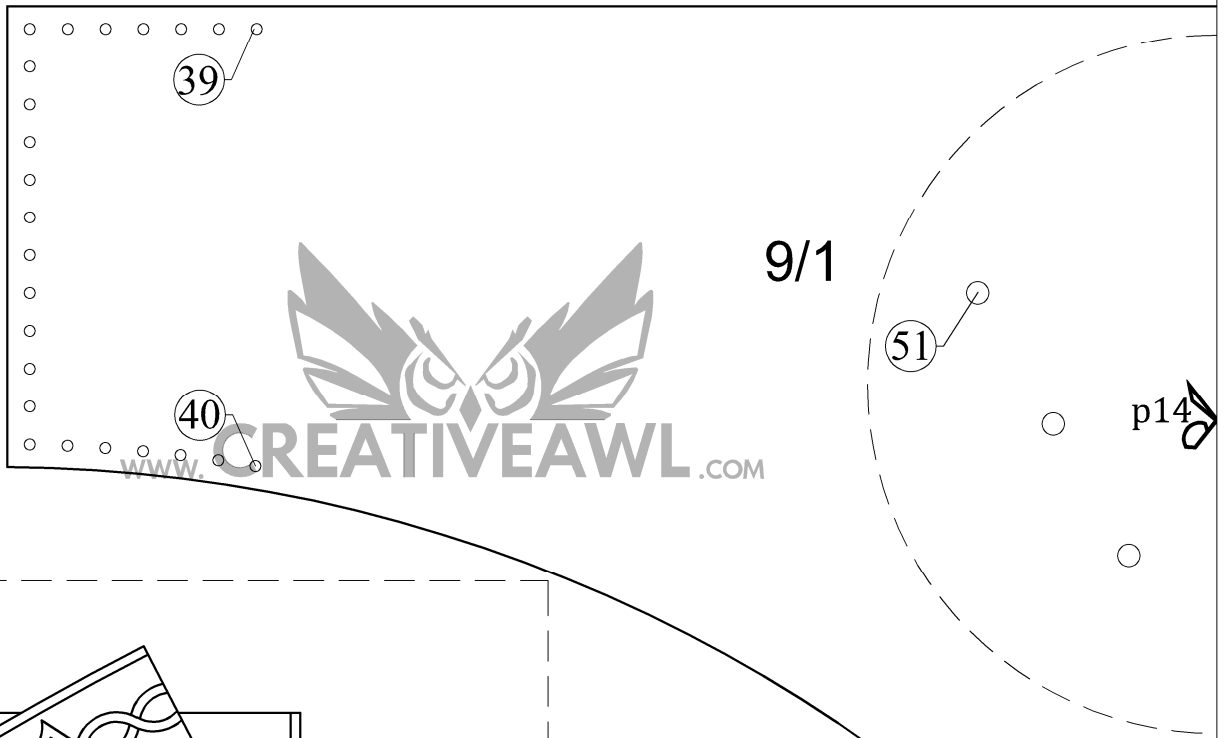

Quiver

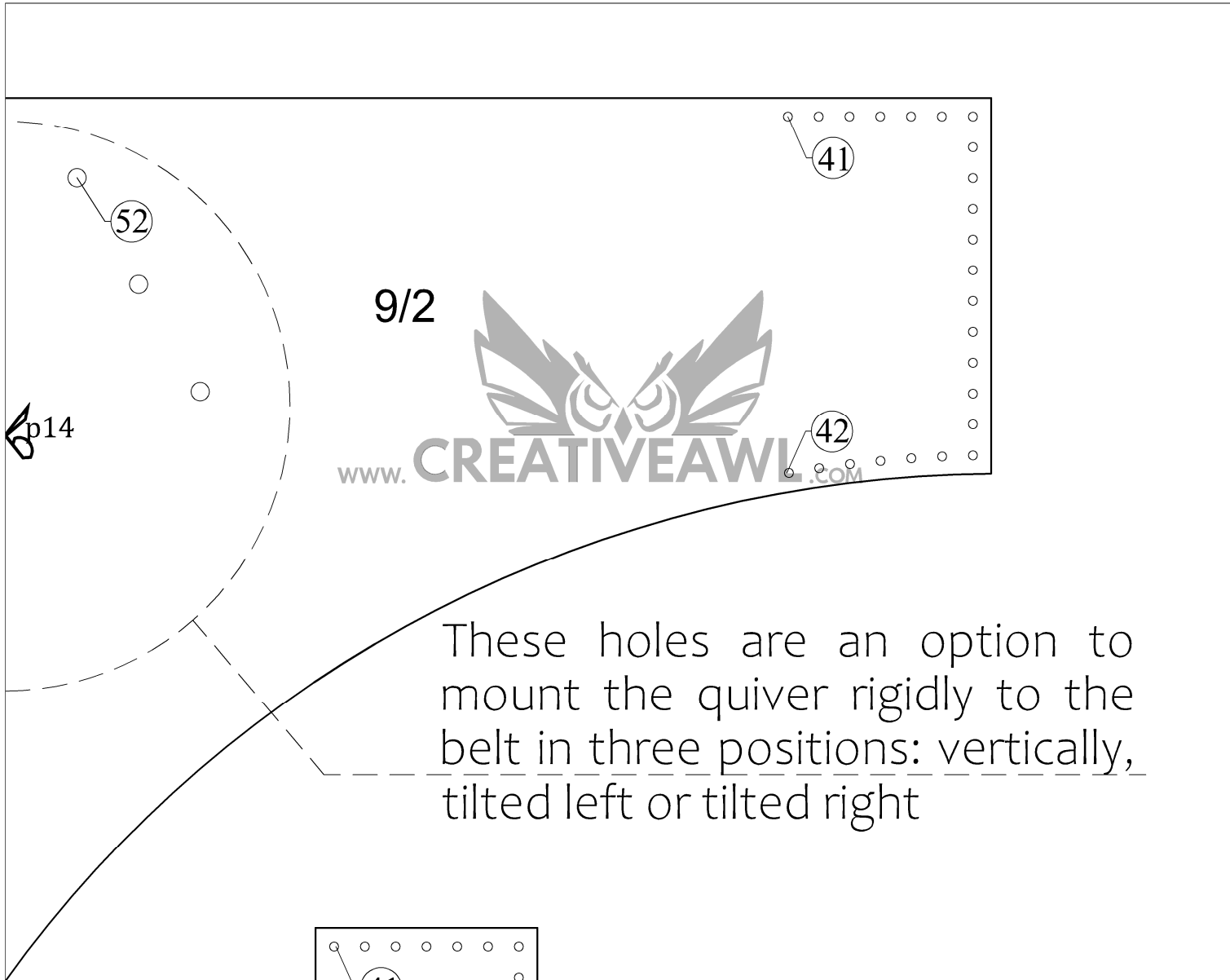

These holes are an option to mount the quiver rigidly to the belt in three positions: vertically, tilted left or tilted right

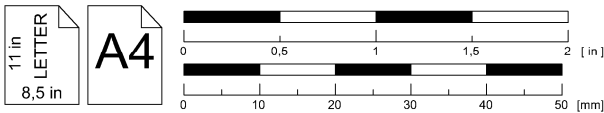
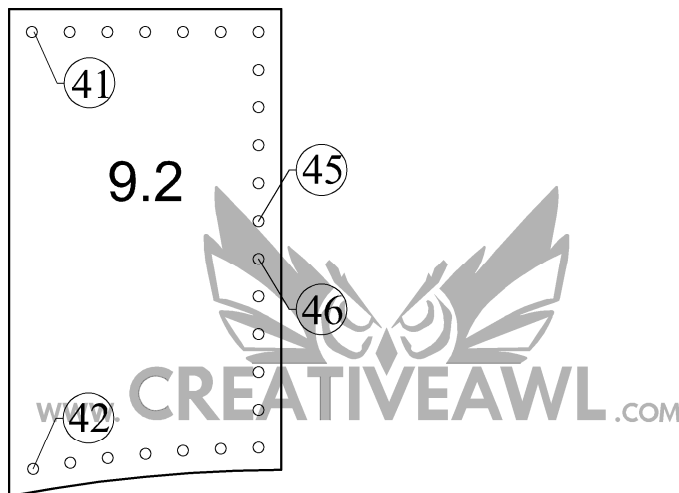

Quiver

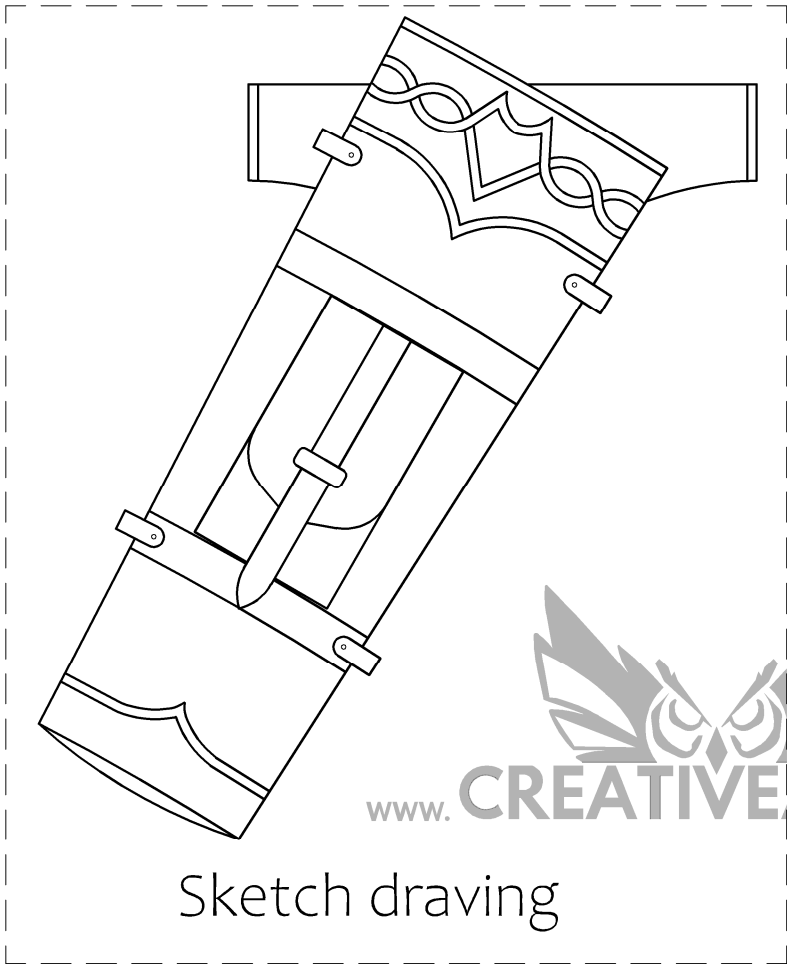
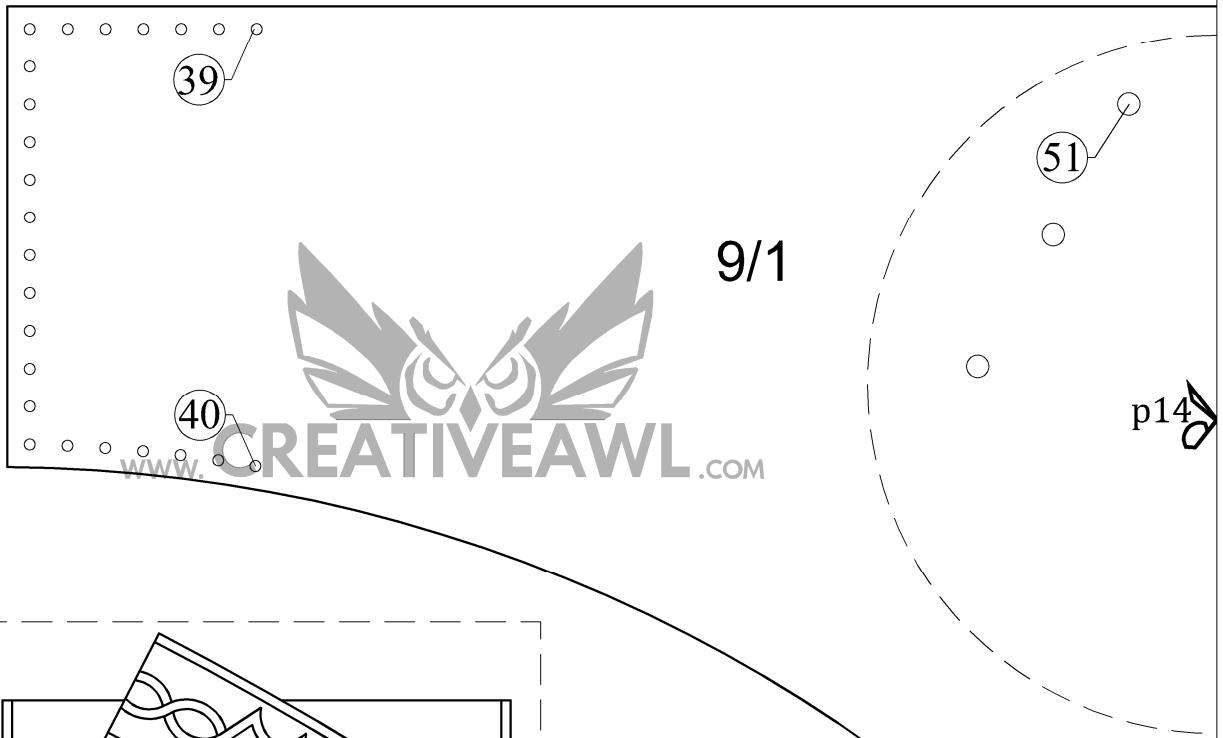

Sketch drawing

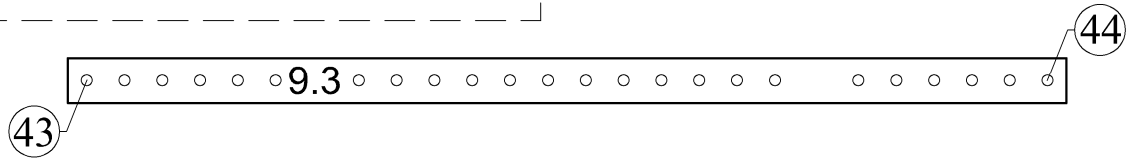
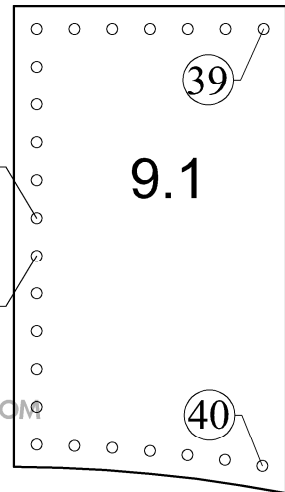

11 in
LETTER
8,5 in

A4

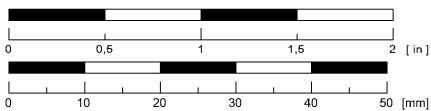

Quiver

9/2

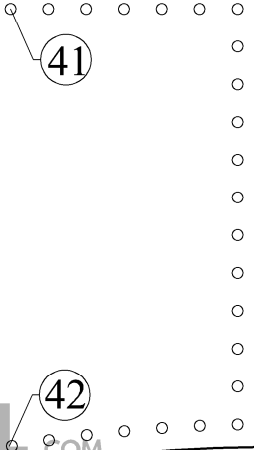
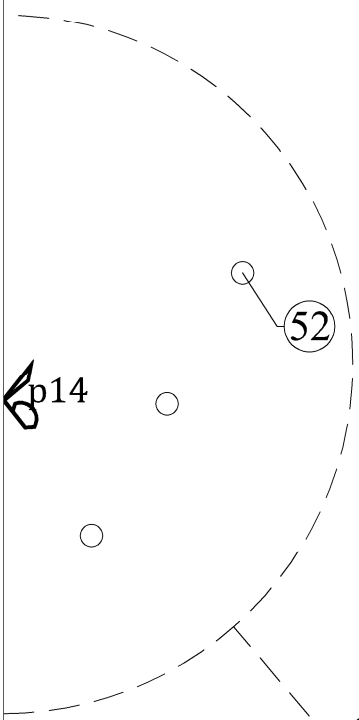

These holes are an option to mount the quiver rigidly to the belt in three positions: vertically, tilted left or tilted right

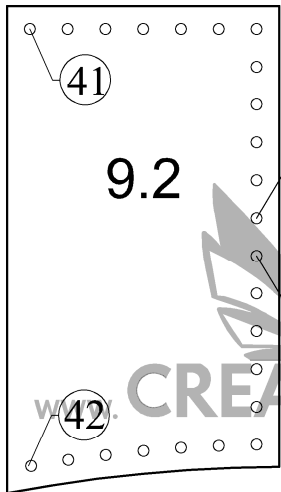

9.2



11 in LETTER 8.5 in

A4

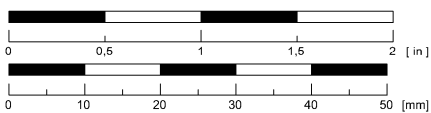

Quiver

54

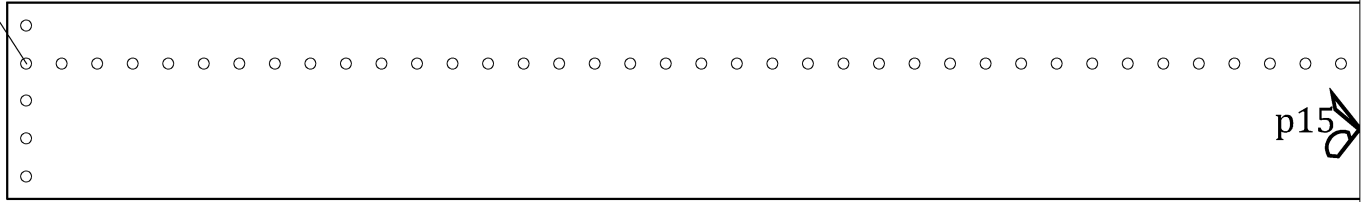

p15

54

55

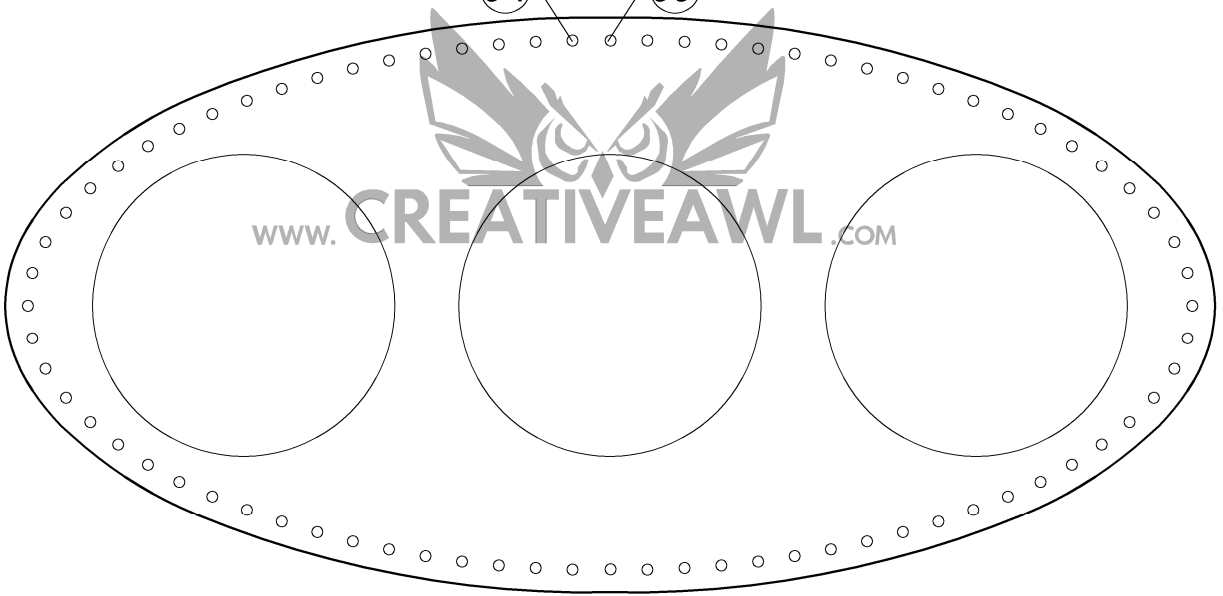

490 - 550 mm ()

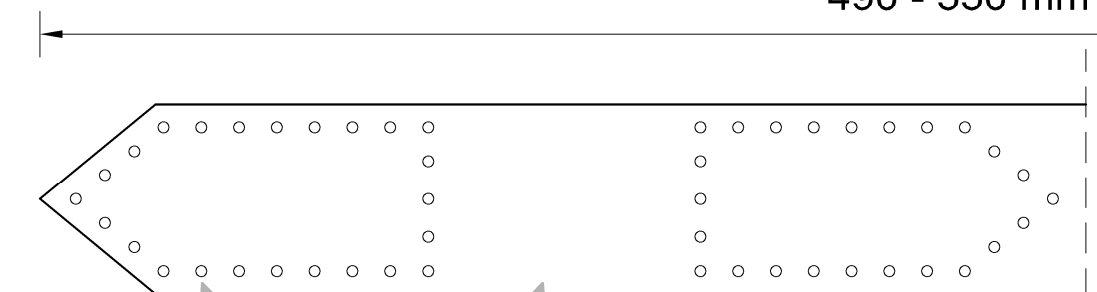

490 - 550 mm (19)

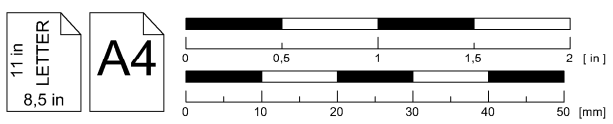
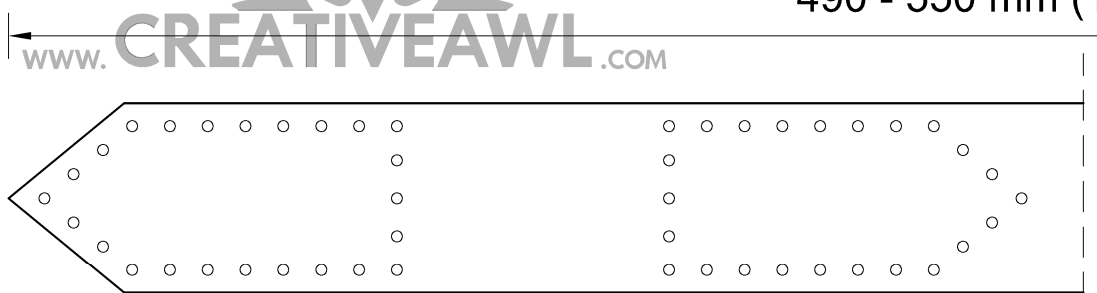

Quiver: separator and back belt

p15

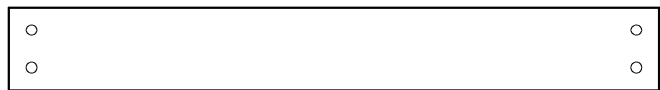

19,6 - 22 in)

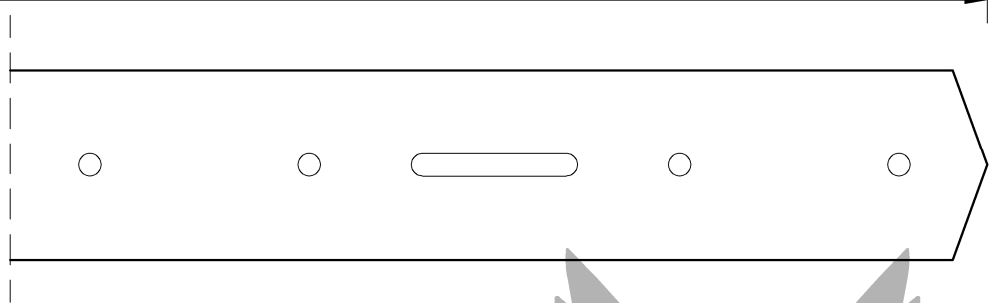

19,6 - 22 in)

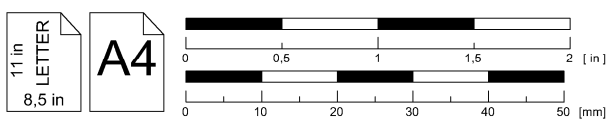
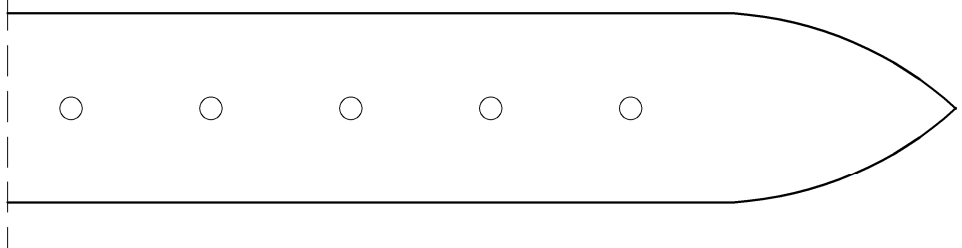

Quiver: separator and back belt