



CREATIVE AWL

**CABRET
MESSENGER BAG**

PREPARED BY:

Patryk Ku,
www.CreativeAwl.com

LET'S GO:

01

PRINT THE PATTERN

- Open your pattern in Adobe Acrobat Reader. Set up options of your printer on A4 paper with 0 margins (if needed).
- Every page has a measure - check does it fit.
- Every printed page **MUST HAVE** a border around! If doesn't - move paper left/ right and print again and check the settings

02

VIDEO TUTORIAL:

https://youtu.be/MKdUdxVS_CI

Cutting patterns:

https://youtu.be/2TNUI_TIk64

03

GIVE A SMILE TO OTHER PEOPLE!

Give a ready product to you family or freind. Give them a smile :)))

Also Check www.CreativeAwl.com for more patterns

04

JOIN OUR FB GROUP

Go there to share your work. Also get more DIY&ideas. We will support you & answer all questions.

<https://www.facebook.com/groups/CreativeAwlPatterns>

MATERIALS

- 5.4 sqft (0.5 sqm) of leather
- Waxed thread (preferable 0,8 mm with 1.2 - 1.5mm holes)
 - 4 x 25mm d-rings
 - 4 rivets
- 2 x 25cm long zippers
- 35mm belt buckle

TOOLS

- sharp knife
- 1.2-1.5 mm hole hole puncher
- hammer
- 2 needles
- paper tape
- a home printer



SHARE YOUR WORK

<https://www.facebook.com/groups/CreativeAwlPatterns>

If you got ANY problem,- don't be shy to ask directly on Etsy or facebook

YOU CAN FIND
THAT LEATHER
ON MY ETSY :)



Cabret messenger bag:

pages 5 - 18

-The number in the circle shows which holes are to be connected. Example: ①

-Numbers 1, 2, 3 (...) without a circle indicate where the piece lies in the overview drawing.

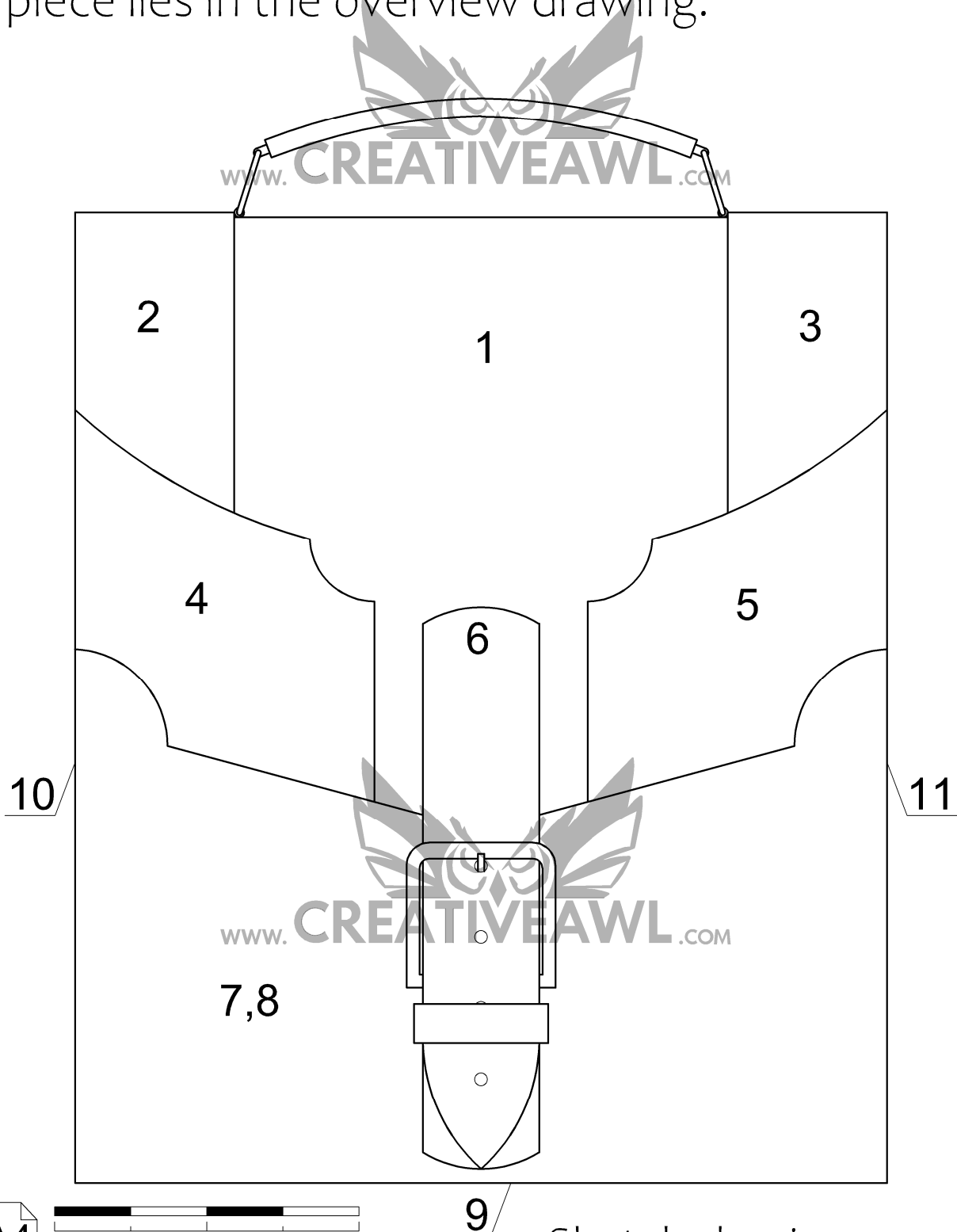

11 in
LETTER
8,5 in

A4

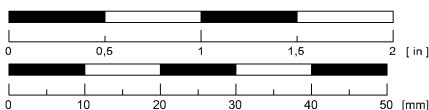

9

Sketch drawing

Leather needed for a Cabret messenger bag:

about 0,50 m2

710 mm (28.4 in)

680 mm (27.2 in)

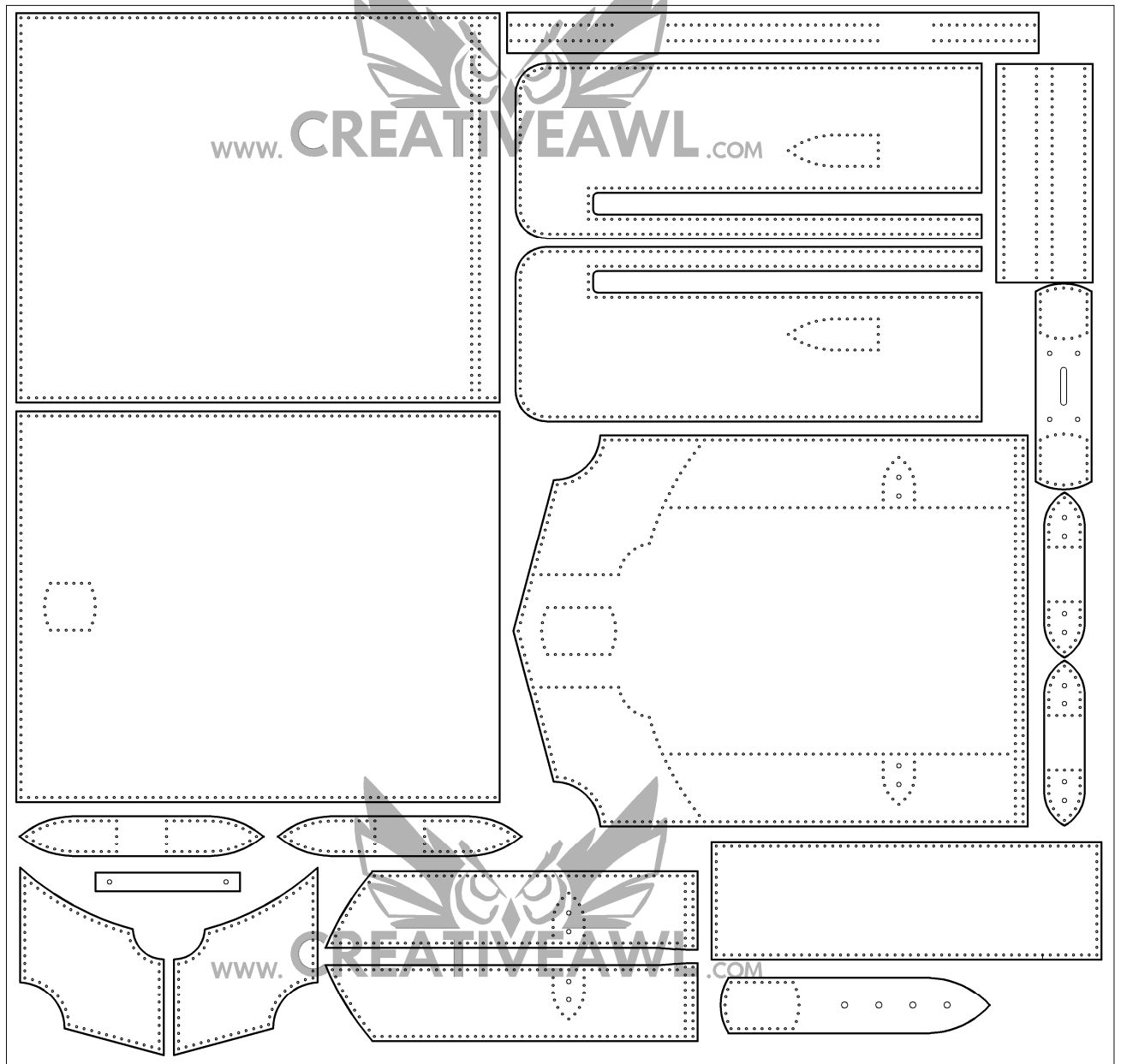

Sketch drawing
Bill of materials

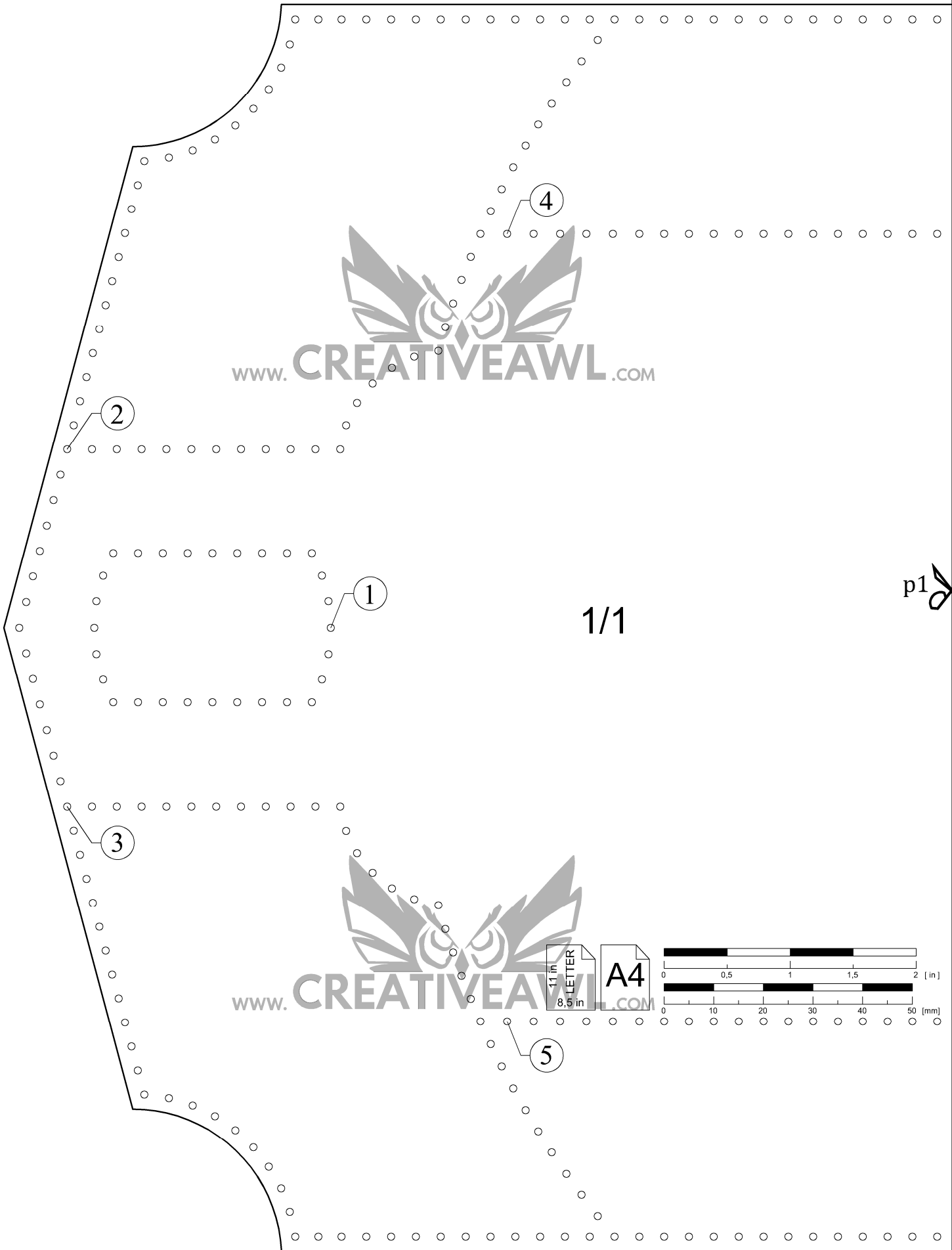

p1 

1/1

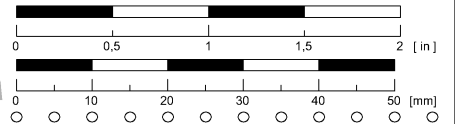

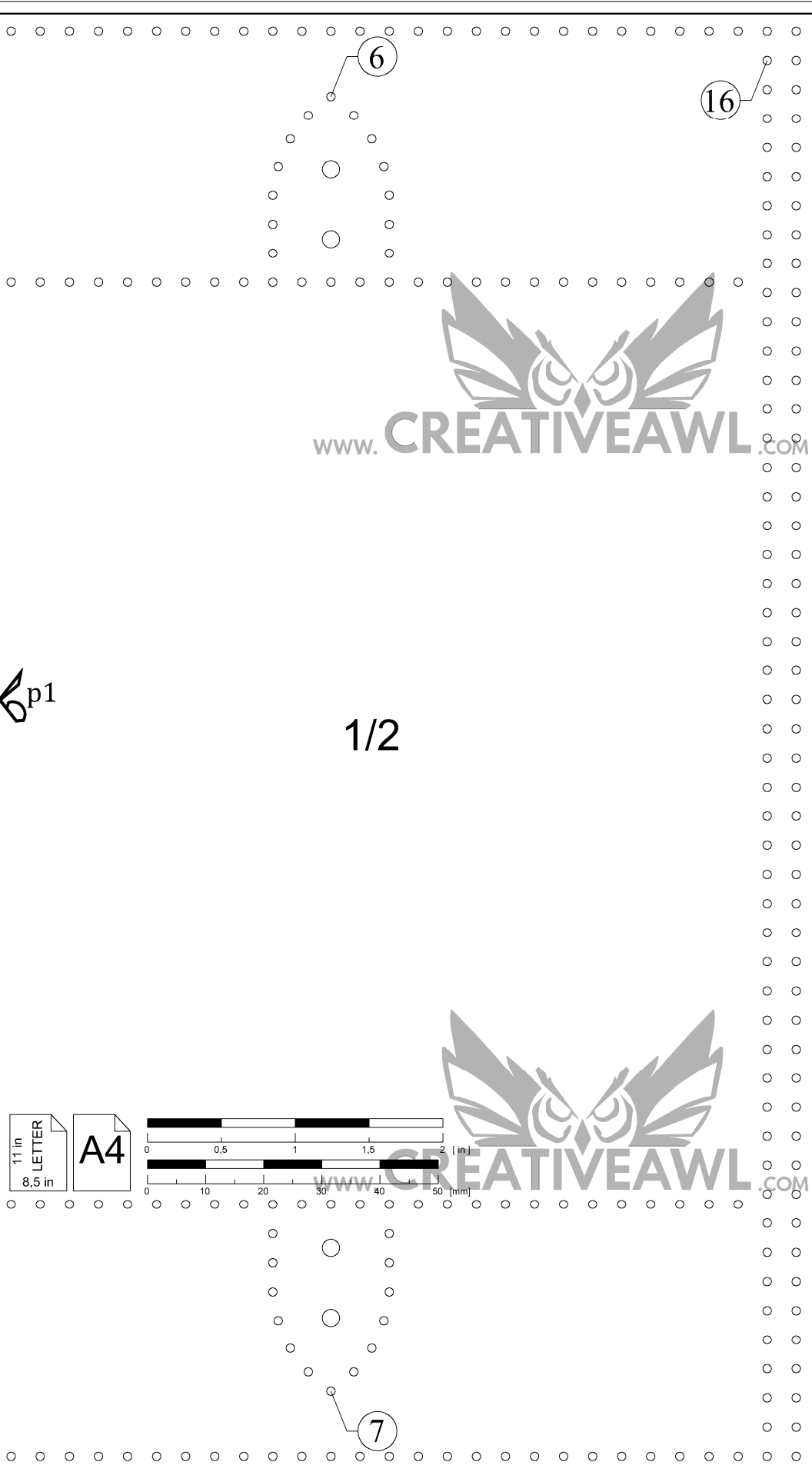

6p1

1/2

11 in
LETTER
8,5 in

A4

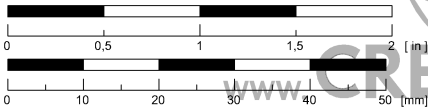

Cabret messenger bag: flap

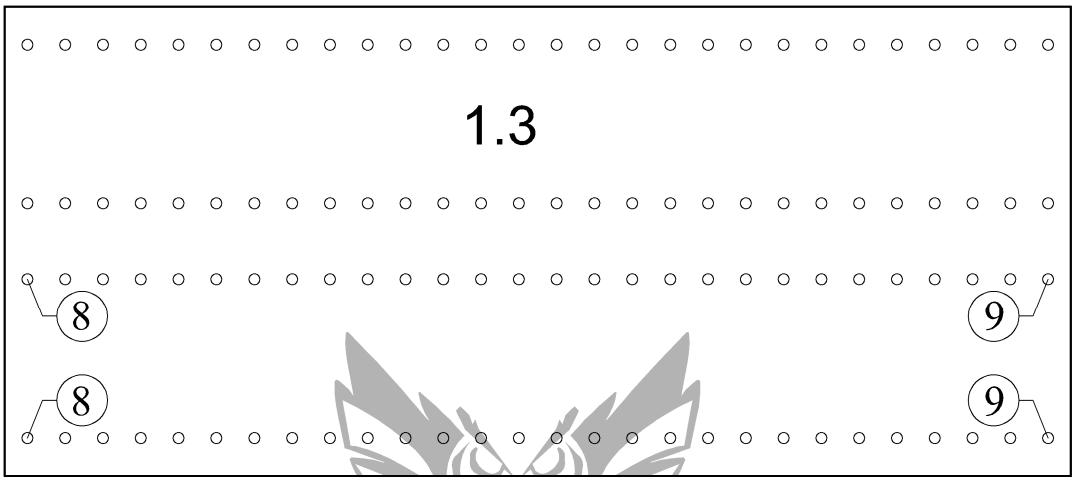

www.CREATIVEAWL.COM

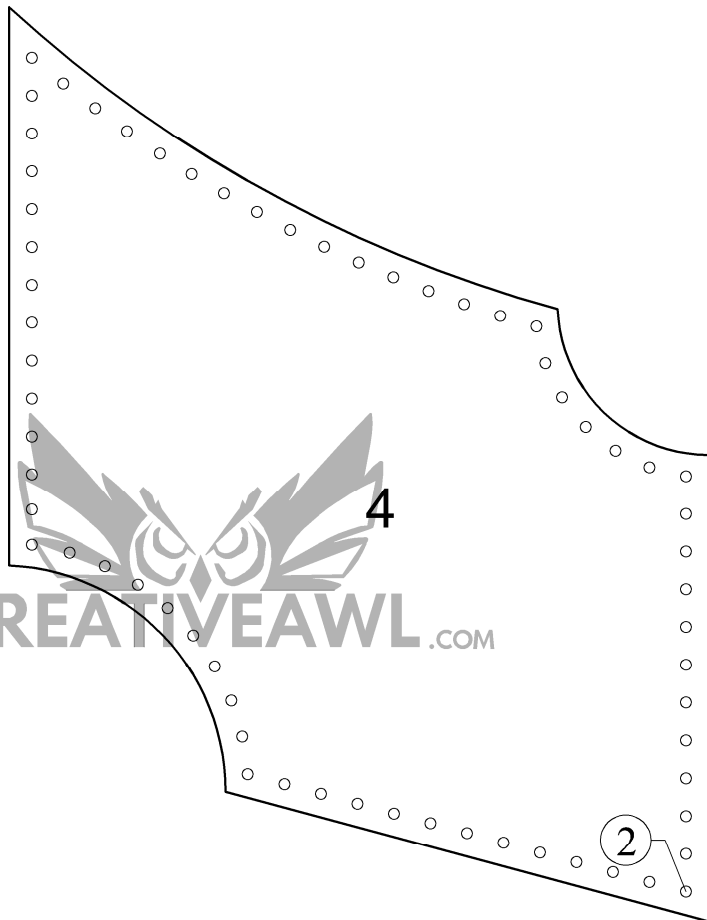
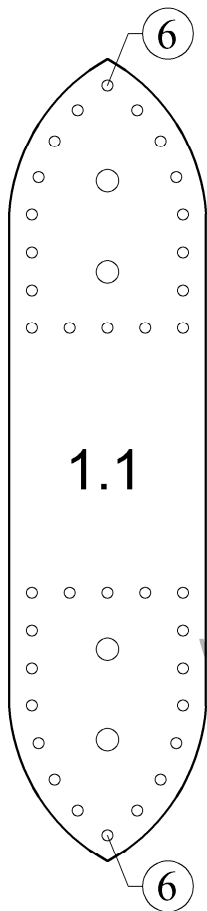
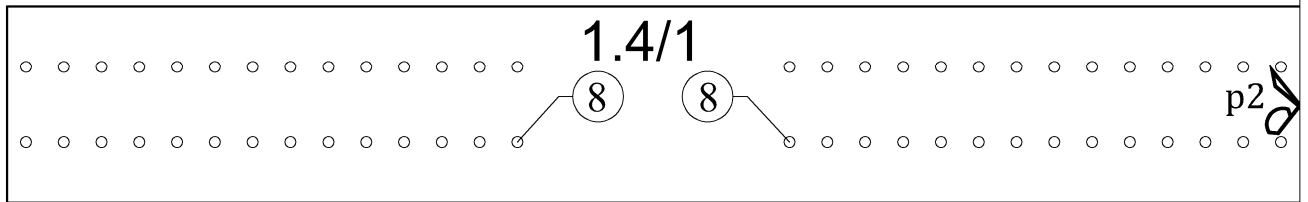

www.CREATIVEAWL.COM

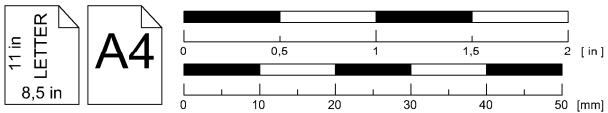

Cabret messenger bag:
flap components

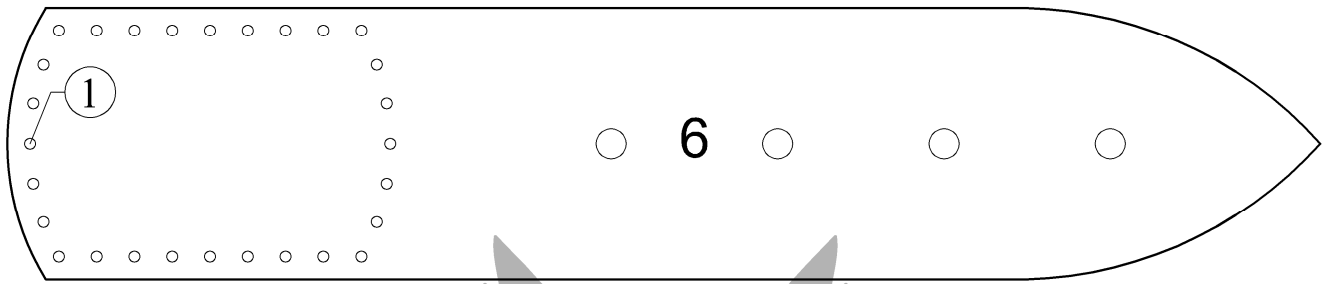

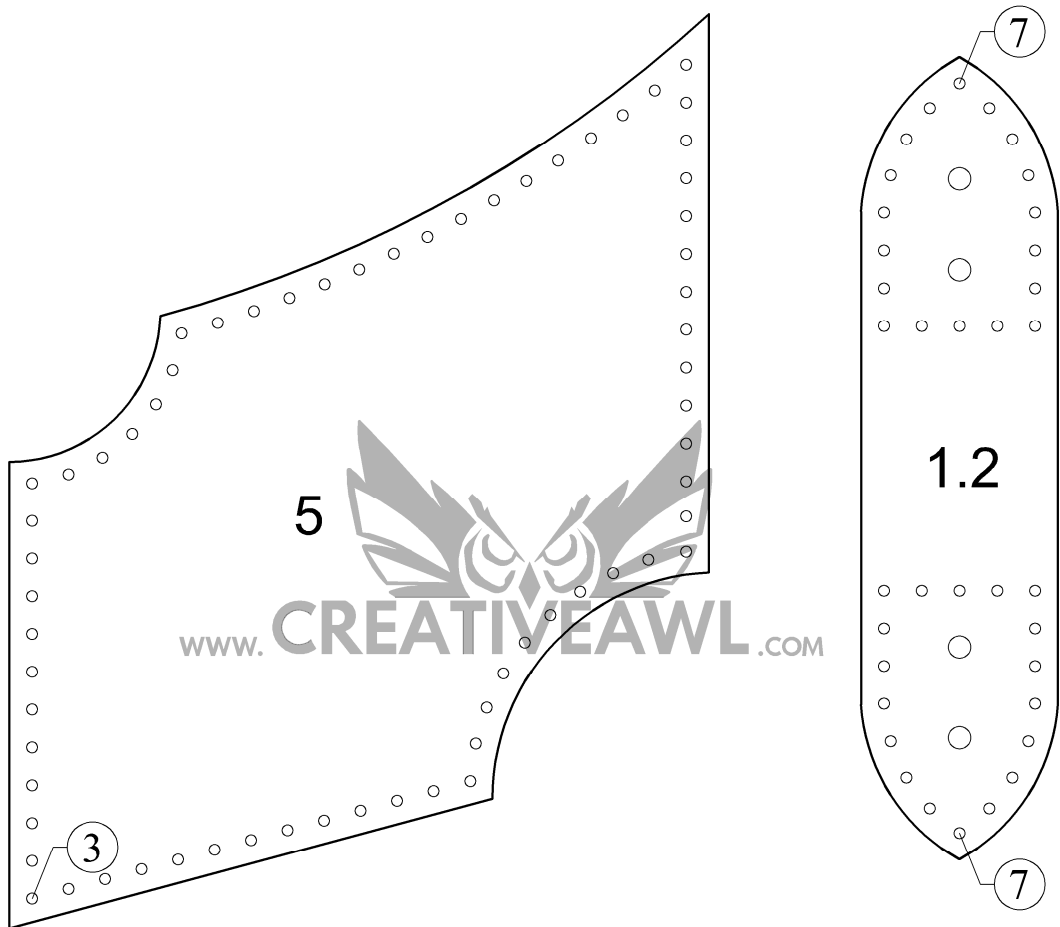
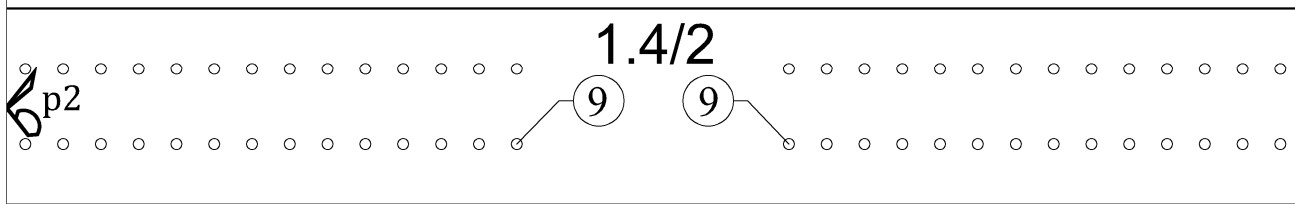

www.CREATIVEAWL.COM

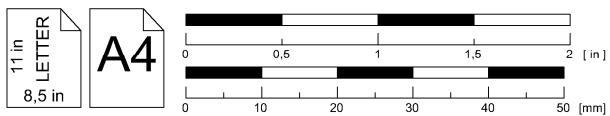

www.CREATIVEAWL.COM

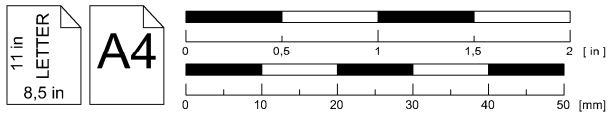
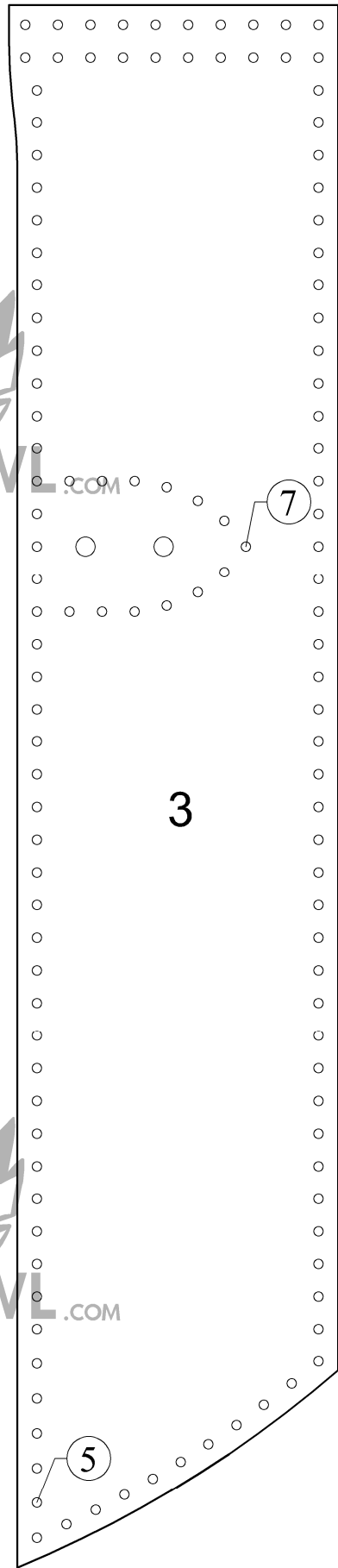
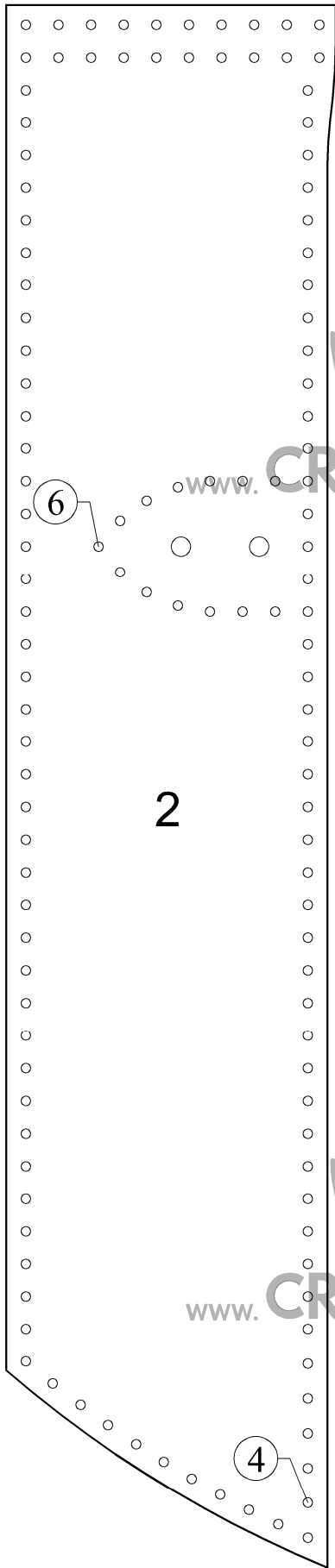

Cabret messenger bag:
flap components



Cabret messenger bag:
flap components

12



10

7/1

p3



13

11 in
LETTER
8,5 in

A4

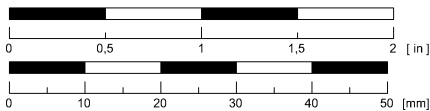

Cabret messenger bag: front

1 2



6 p3

7/2

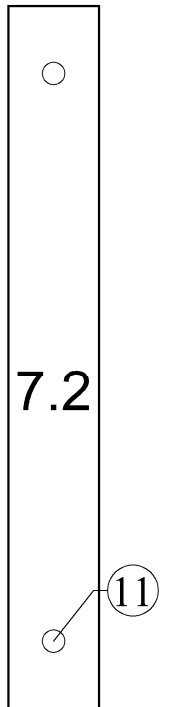
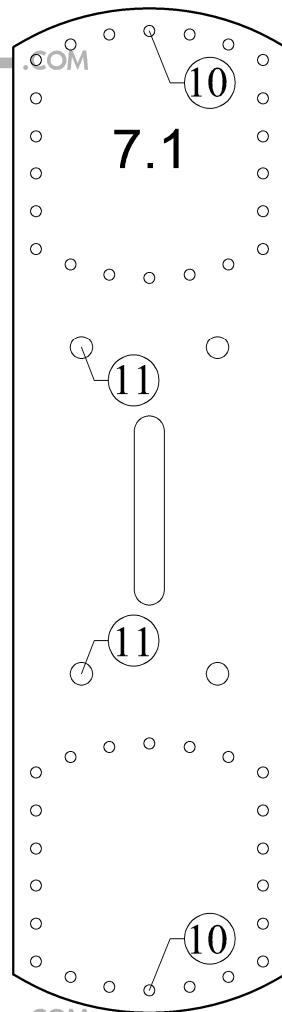

11 in
LETTER
8,5 in

A4

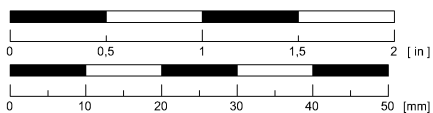

15



WWW.CREATIVEAWL.COM

8/1

p4



WWW.CREATIVEAWL.COM

14

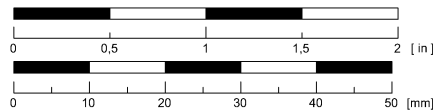
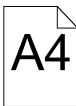
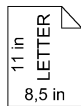

Cabret messenger bag: back

14



p4

8/2

11 in
LETTER
8,5 in

A4

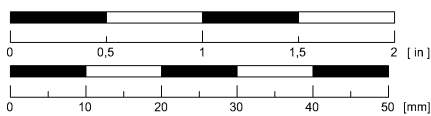

16



11 in
LETTER
8,5 in

A4

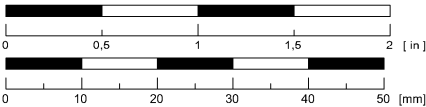

Cabret messenger bag:
sides

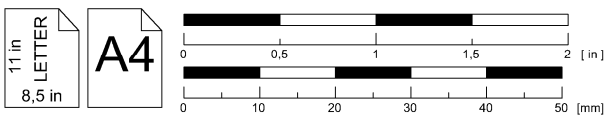
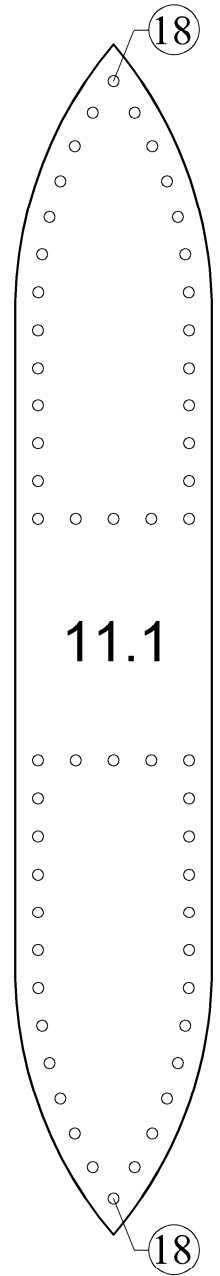
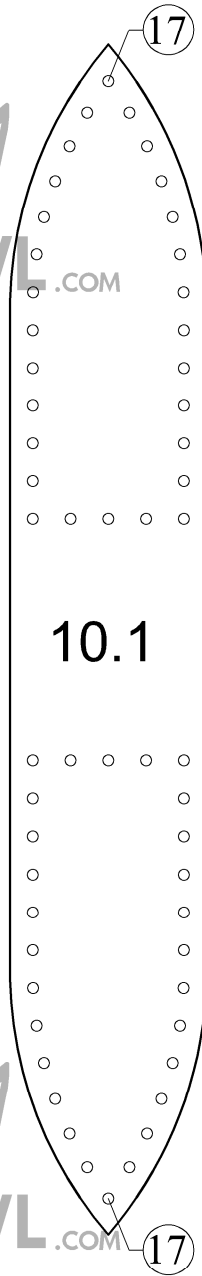
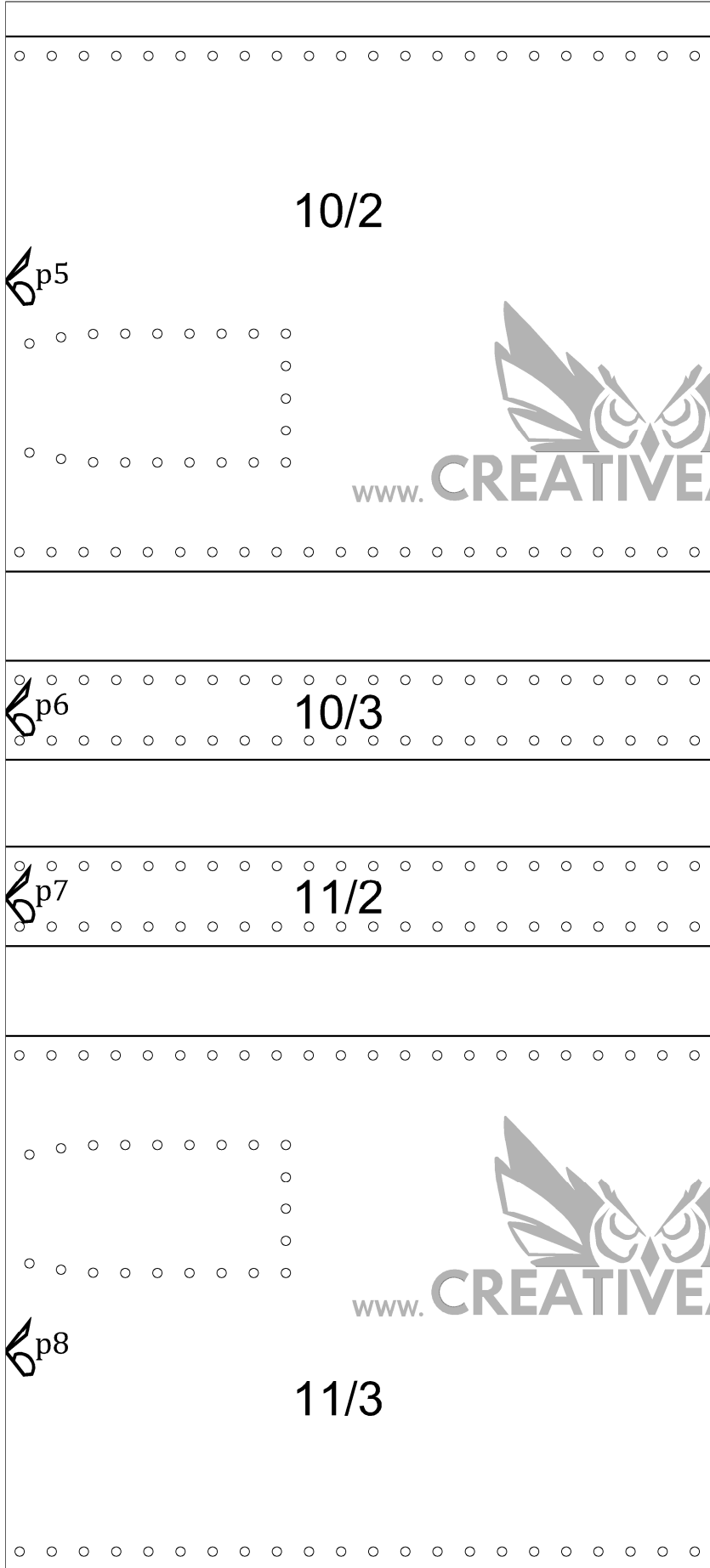

Cabret messenger bag:
sides

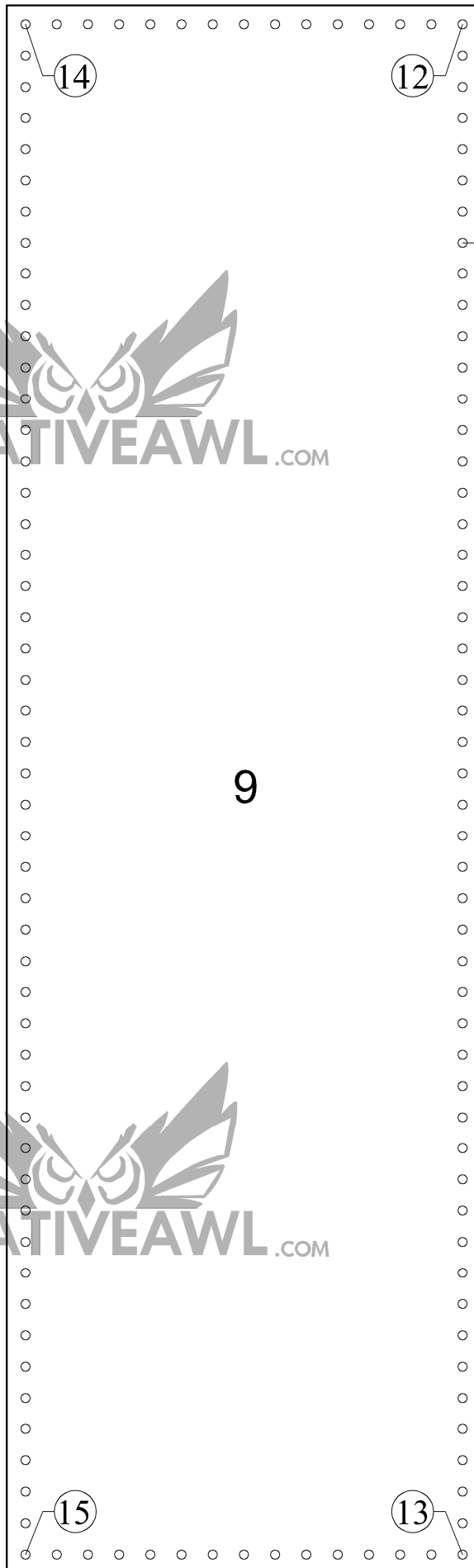
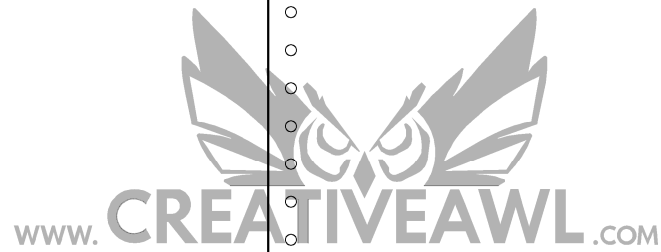

Cabret messenger bag: bottom

11 in
LETTER
8,5 in

A4

