



CREATIVE AWL
**ORIGINAL
PATTERNS**



Draco Nightmare Briefcase



 **YouTube**
VIDEO TUTORIAL

**EASY TO
PRINT**
PDF >>>>
PATTERN

LET'S GO!

• & don't forget check out our free patterns!



1



PRINT THE PATTERN

- Open your pattern in Adobe Acrobat Reader, or any web browser.
- Every page has a measure - check does it fit.
- Every printed page **MUST HAVE** a border around! If doesn't - move paper left/ right and print again

2



FOLLOW VIDEO INSTRUCTIONS

- Video tutorial:
<https://youtu.be/ai39WVuzyW4>
- Cutting patterns:
https://www.youtube.com/watch?v=2TNUI_TIk64



3



GIVE A SMILE TO OTHER PEOPLE !

- Give a ready product to you family or friend.
Give them a smile :)))
- Also Check www.CreativeAwl.com for more patterns

4



JOIN OUR FB GROUP

- Go there to share your work. Also get more DIY&ideas. We will support you & answer all questions.
<https://www.facebook.com/groups/CreativeAwlPatterns/>



YOU NEED

MATERIALS

- 14 SQFT (1,3 SQM)
- PREFERABLY VEGETABLE TANNED LEATHER (PREFERABLE A 5OZ (2MM))
- WAXED THREAD (PREFERABLE 0,8MM)
- 4 X 25MM (1") D-RINGS
- 1 X 25MM (1") BUCKLE
- FEW RIVETS

TOOLS

- SHARP KNIFE
- 1.2 - 1.5 MM HOLE PUNCHER / PRICKING IRONS OR AWL
- HAMMER
- 2 NEEDLES
- PAPER TAPE
- A HOME PRINTER

SHARE YOUR WORK

[https://www.facebook.com/groups/
CreativeAwlPatterns](https://www.facebook.com/groups/CreativeAwlPatterns)

Draco nightmare briefcase:

pages 4 - 48

-The number in the circle shows which holes are to be connected. Example: ①

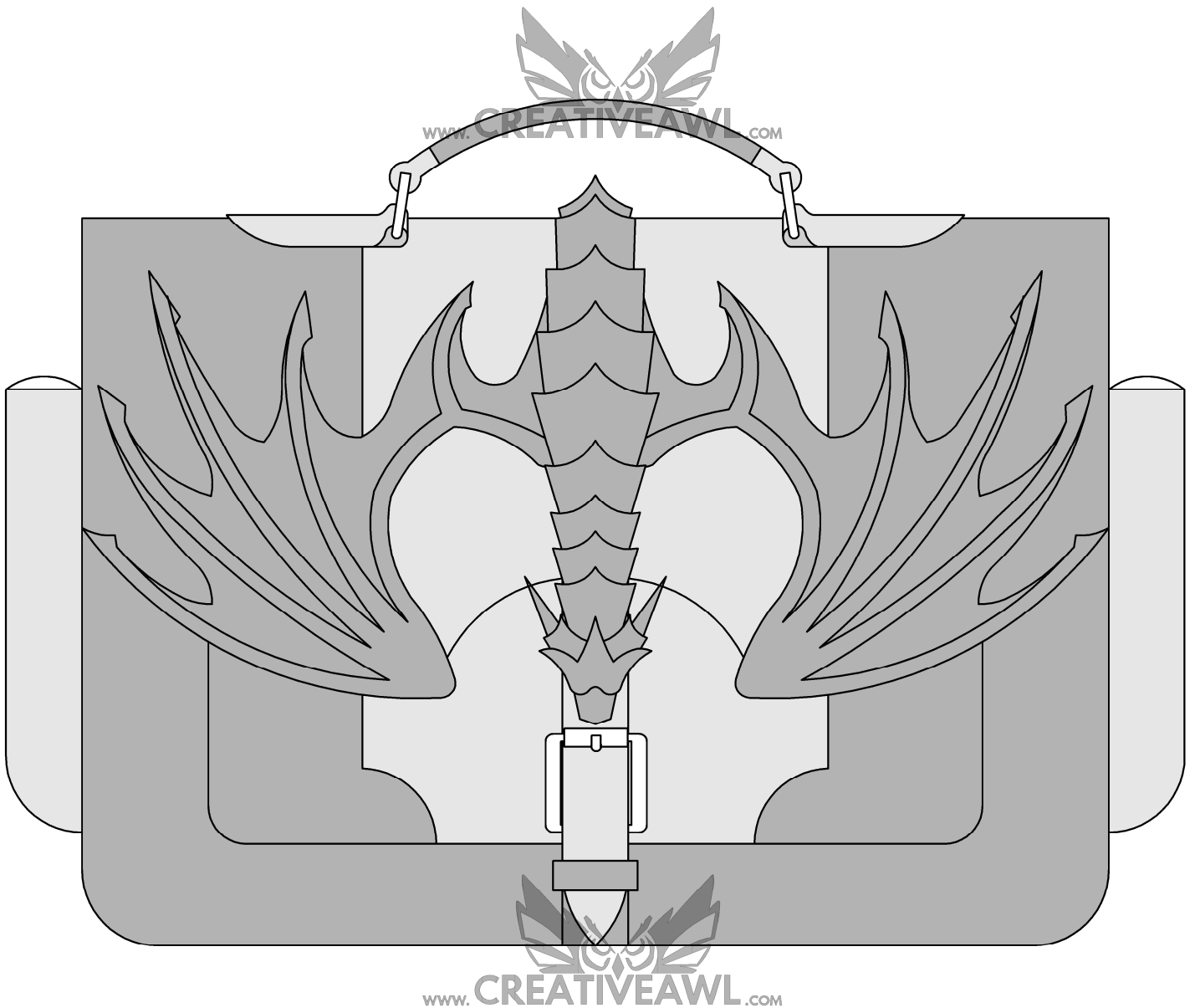

Sketch drawing

Leather needed for a Draco nightmare
briefcase:

about 1.30 m2

990 mm (39 in)

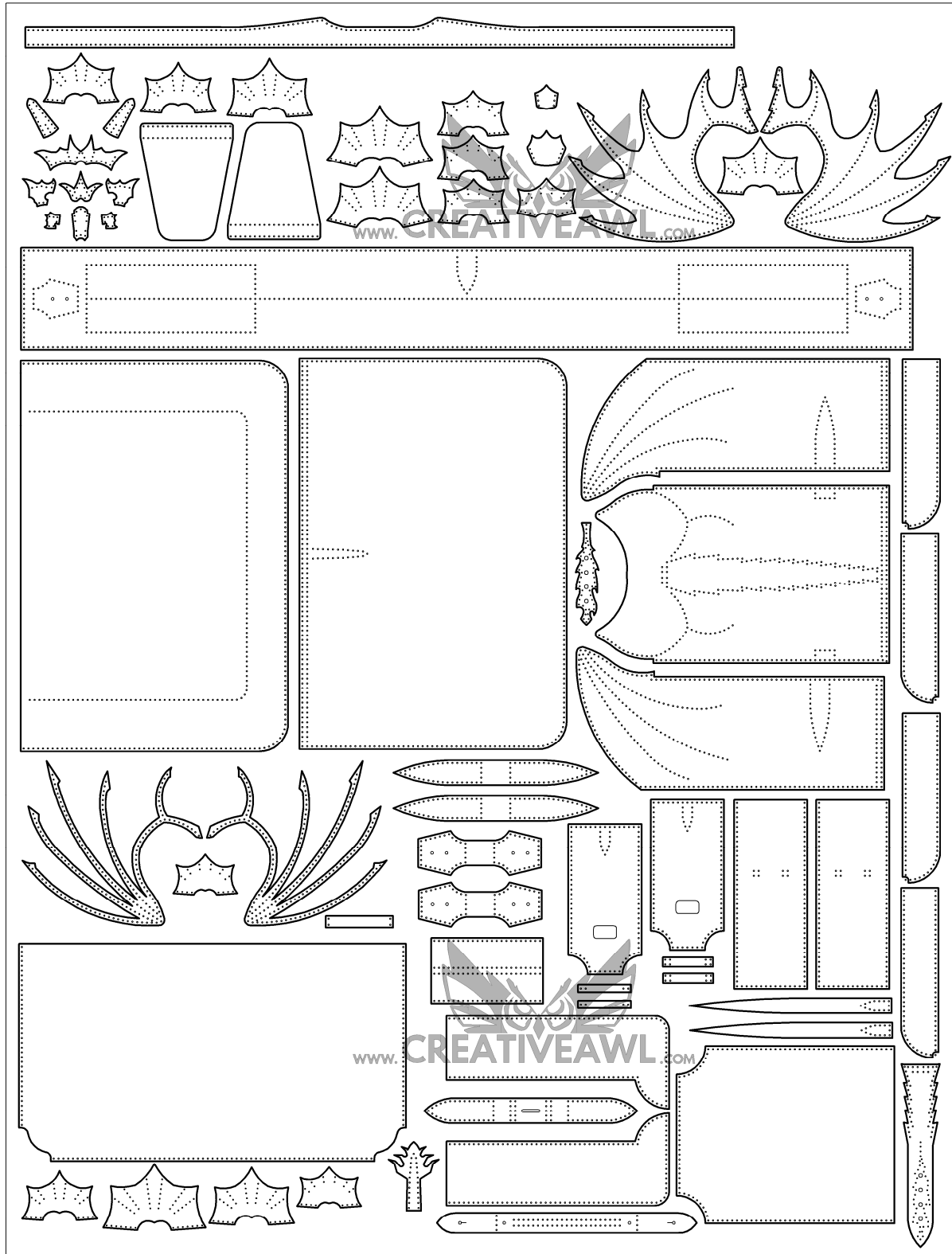
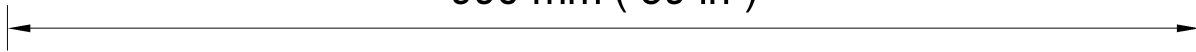

1300 mm (52 in)



Sketch drawing
Bill of materials

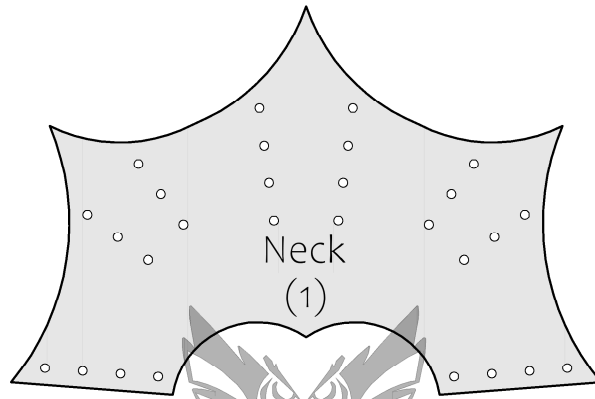

www.CREATIVEAWL.com

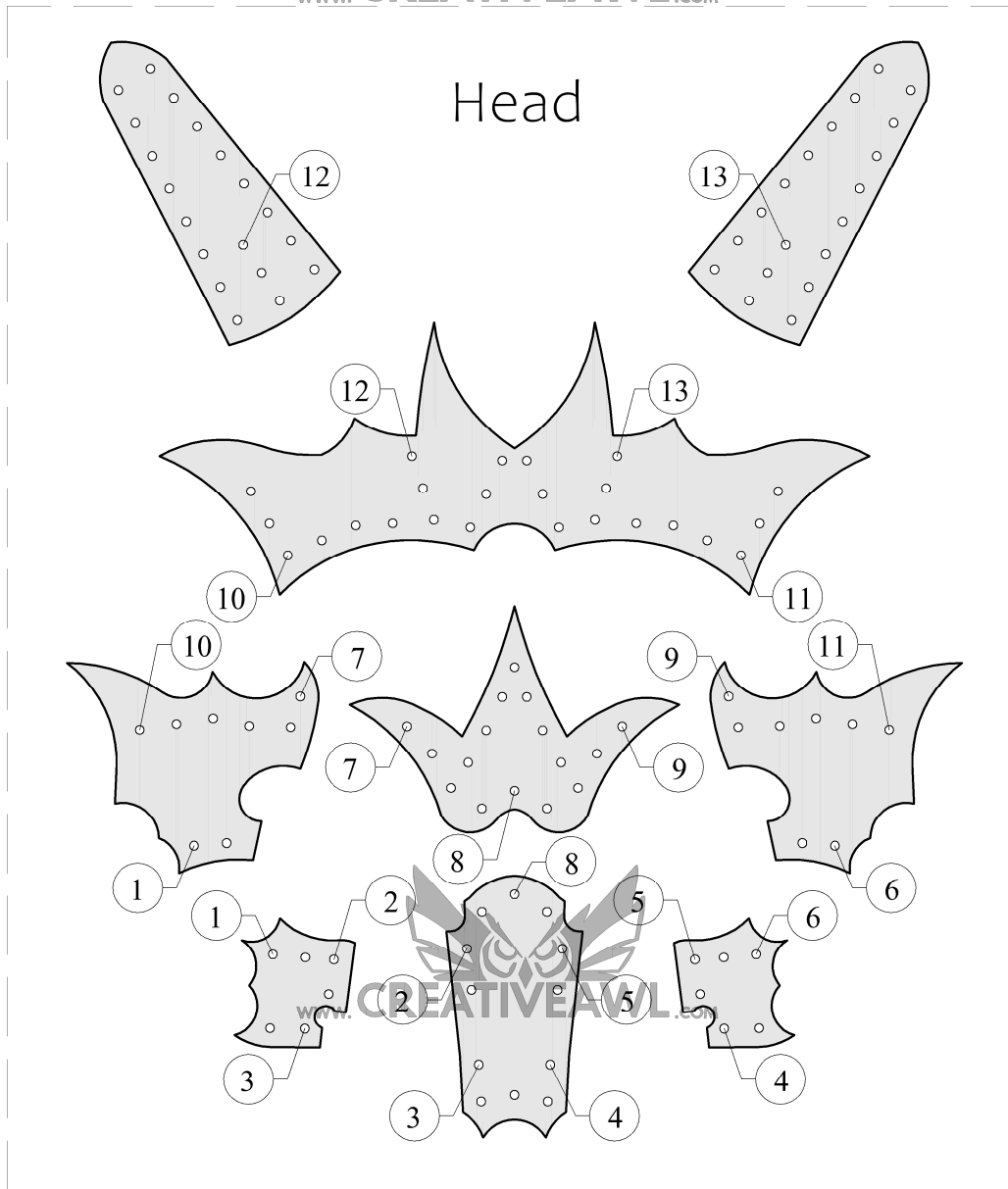

Draco nightmare
briefcase

11 in
LETTER
8,5 in

A4

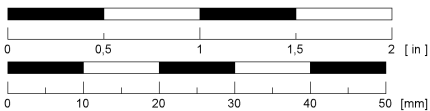

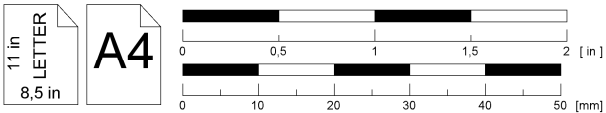
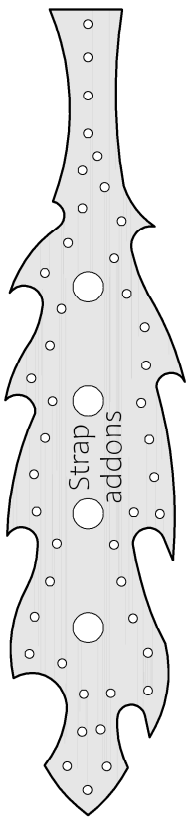
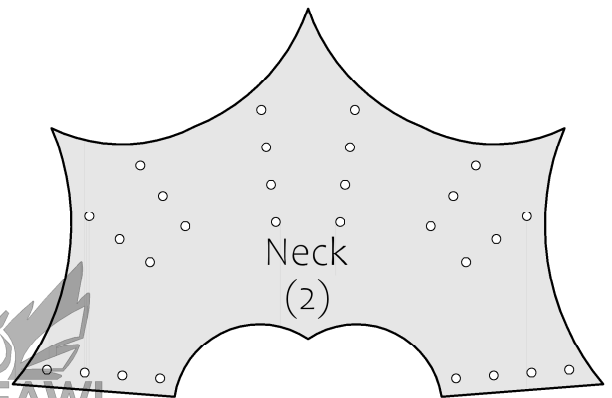
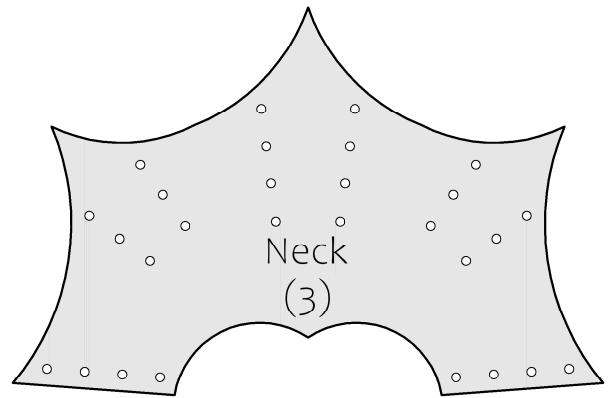
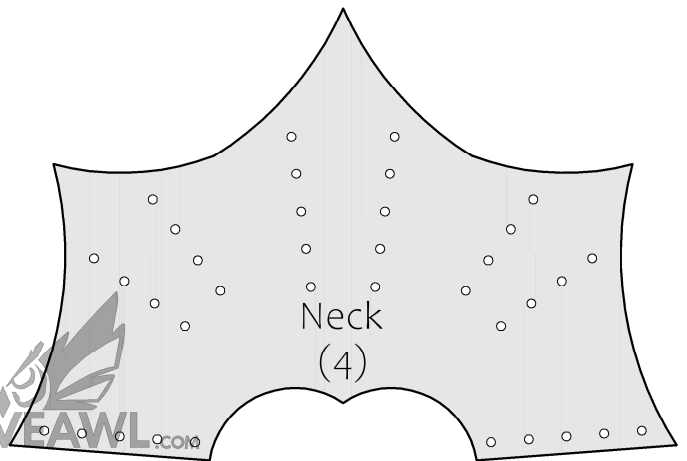
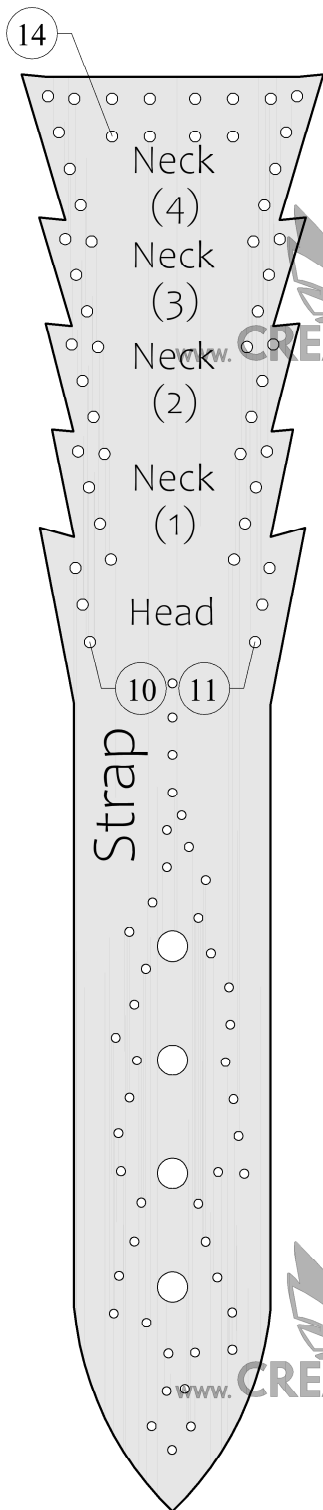

Draco nightmare
briefcase

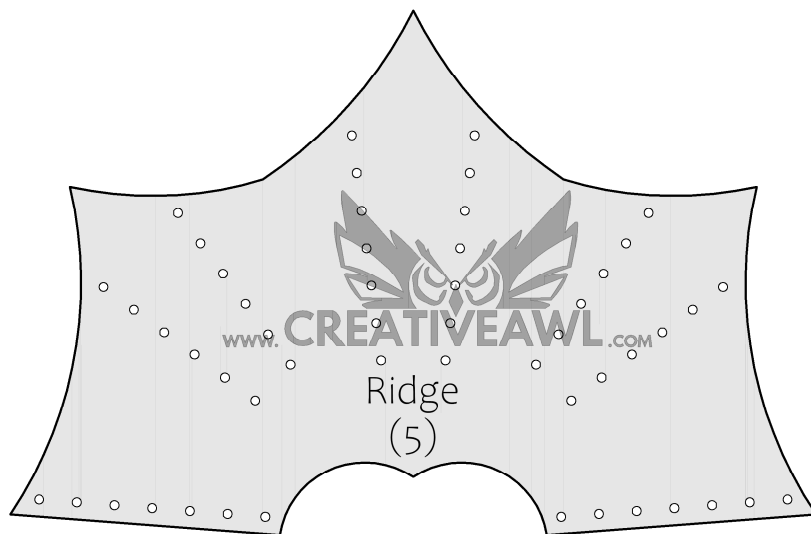
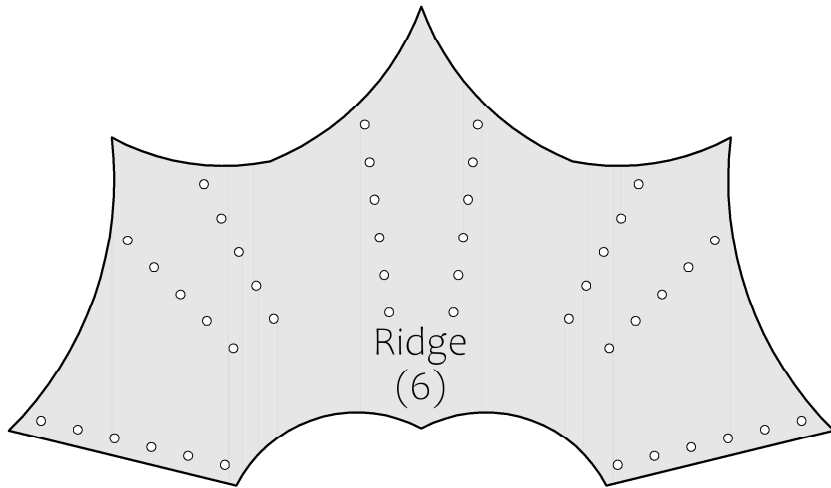
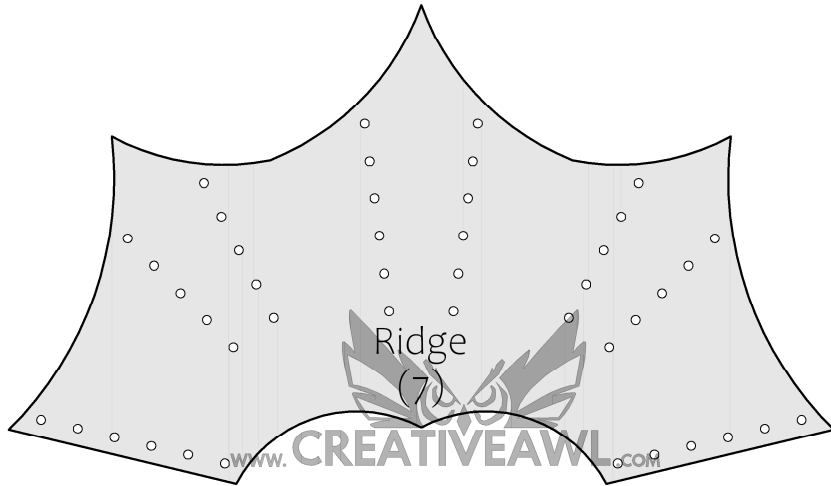

11 in
LETTER
8,5 in

A4

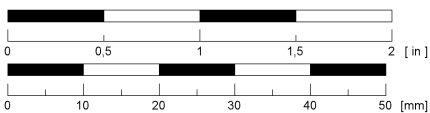

Draco nightmare
briefcase

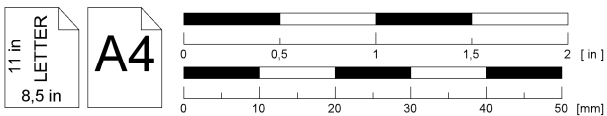
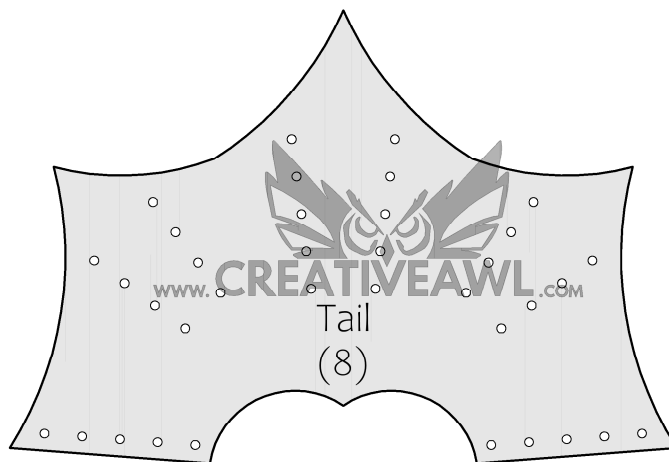
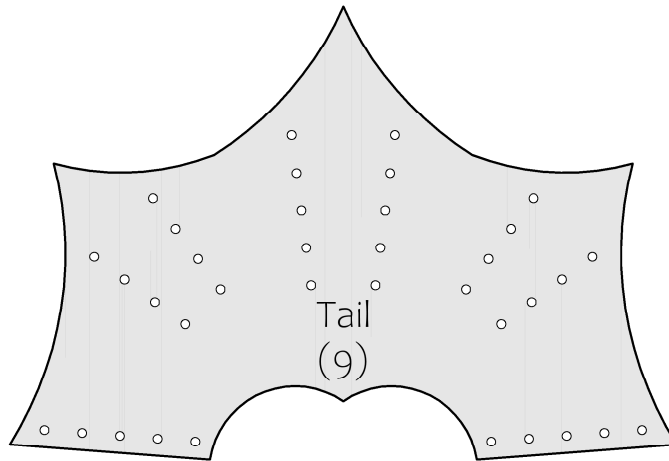

Draco nightmare
briefcase

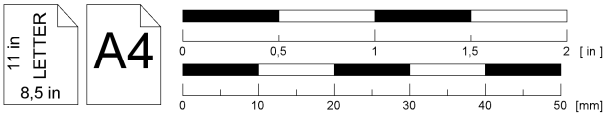
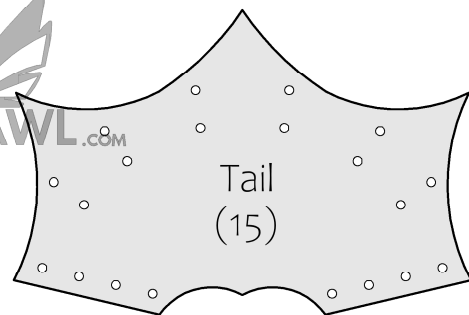
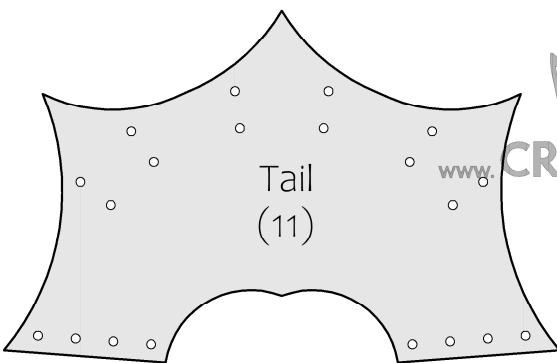
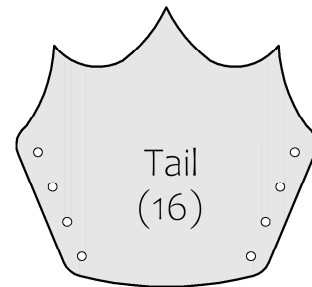
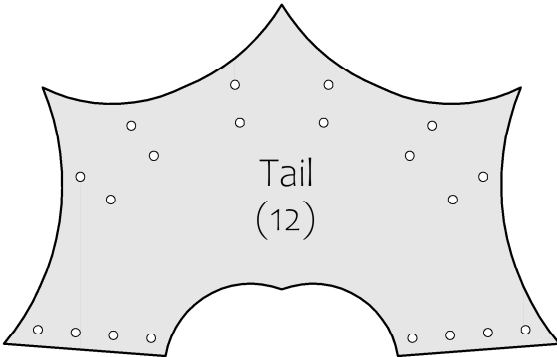
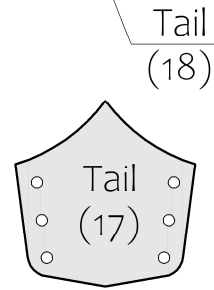
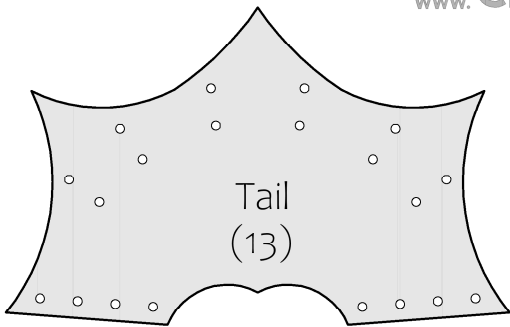
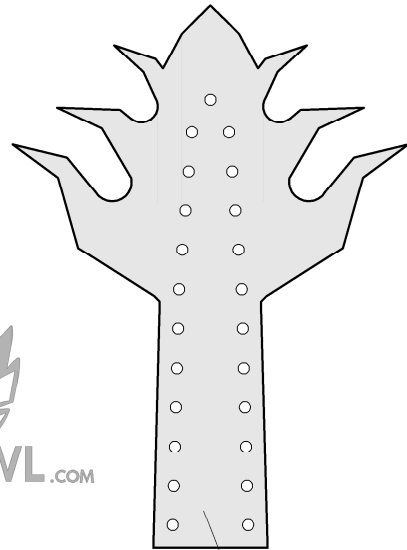
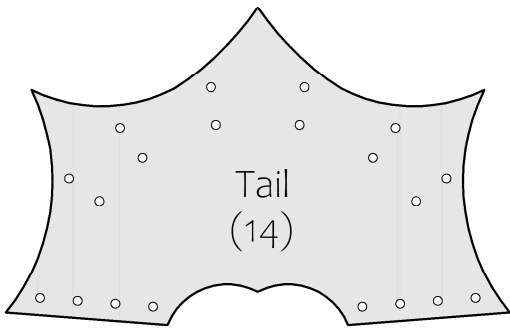

Draco nightmare briefcase



20

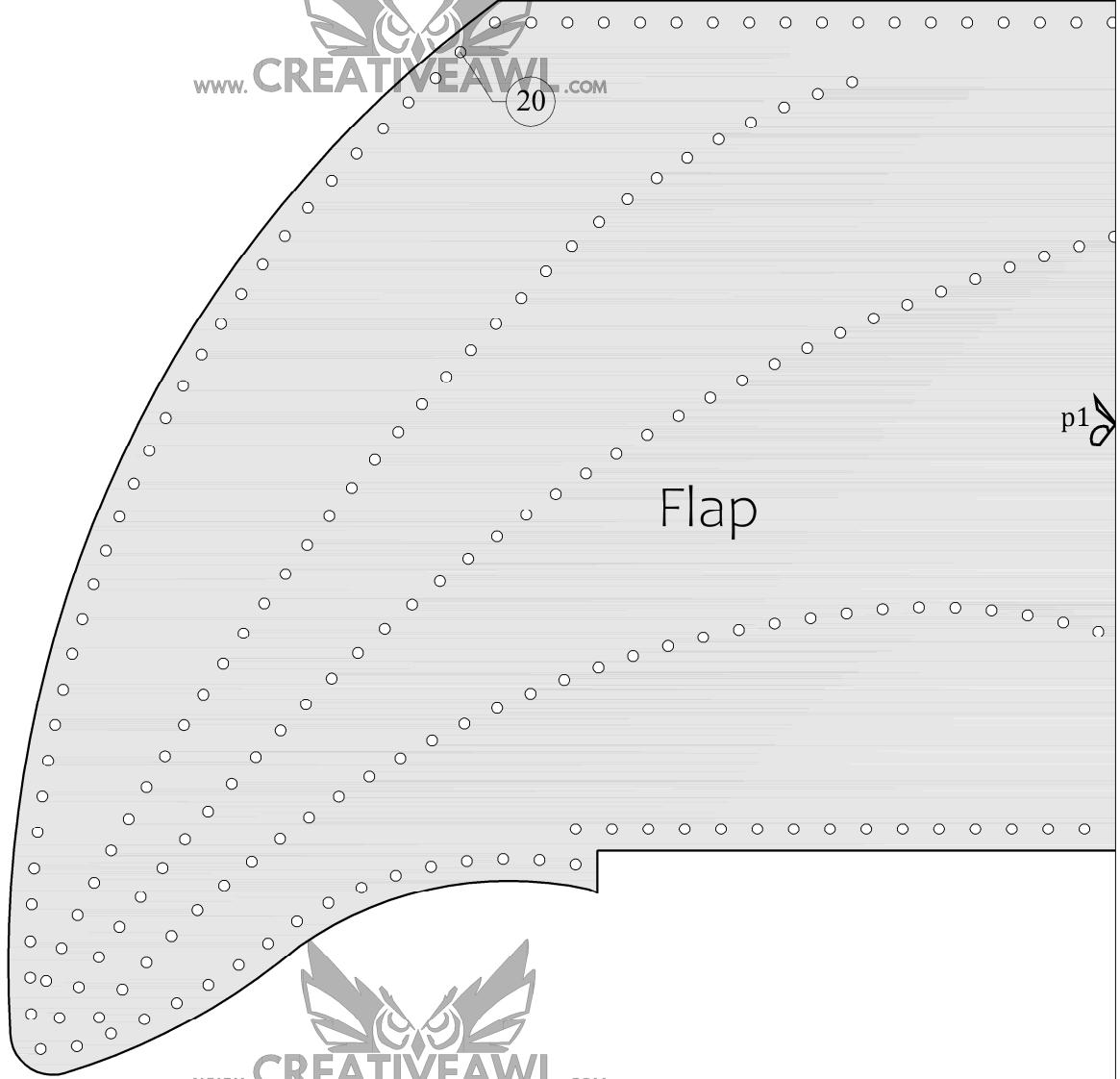

11 in
LETTER
8,5 in

A4

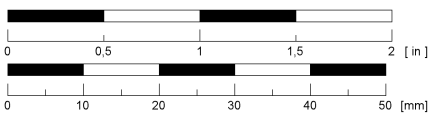

Draco nightmare
briefcase

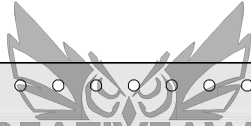

www.CREATIVEAWL.COM

19

p1

Flap

15



www.CREATIVEAWL.COM

11 in
LETTER
8,5 in

A4

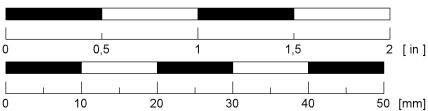

Draco nightmare
briefcase

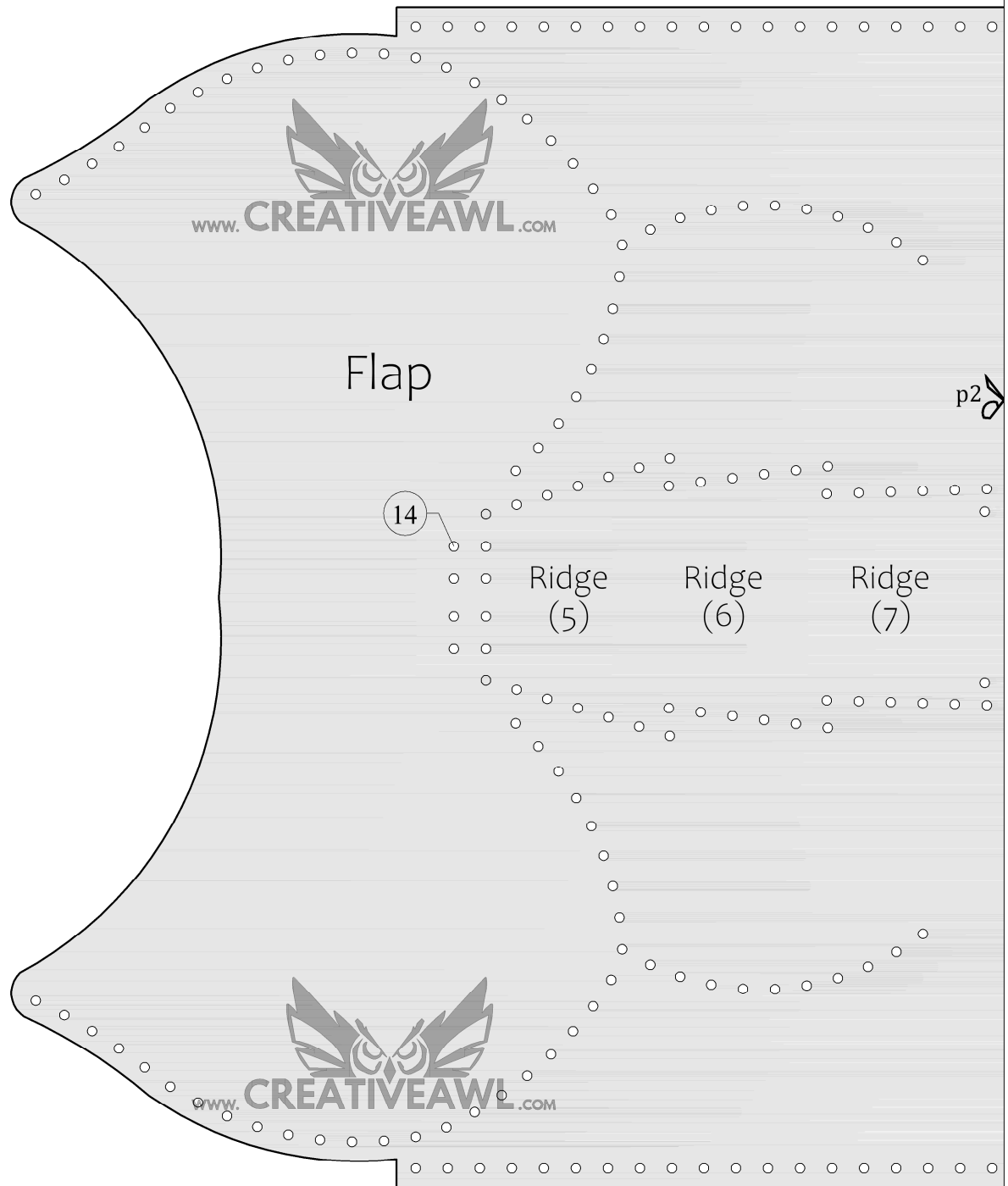

11 in
LETTER
8,5 in

A4

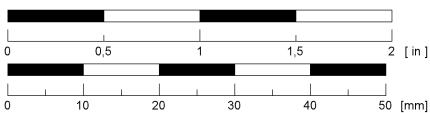

Draco nightmare
briefcase



11 in
8.5 in
LETTER

A4

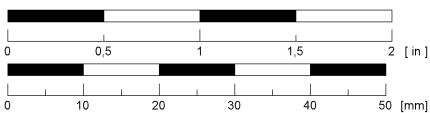

Draco nightmare
briefcase

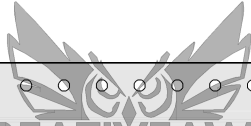

www.CREATIVEAWL.COM



p3

Flap



www.CREATIVEAWL.COM

11 in
LETTER
8,5 in

A4

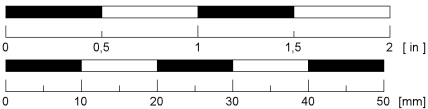

Draco nightmare
briefcase



www.CREATIVEAWL.COM

21

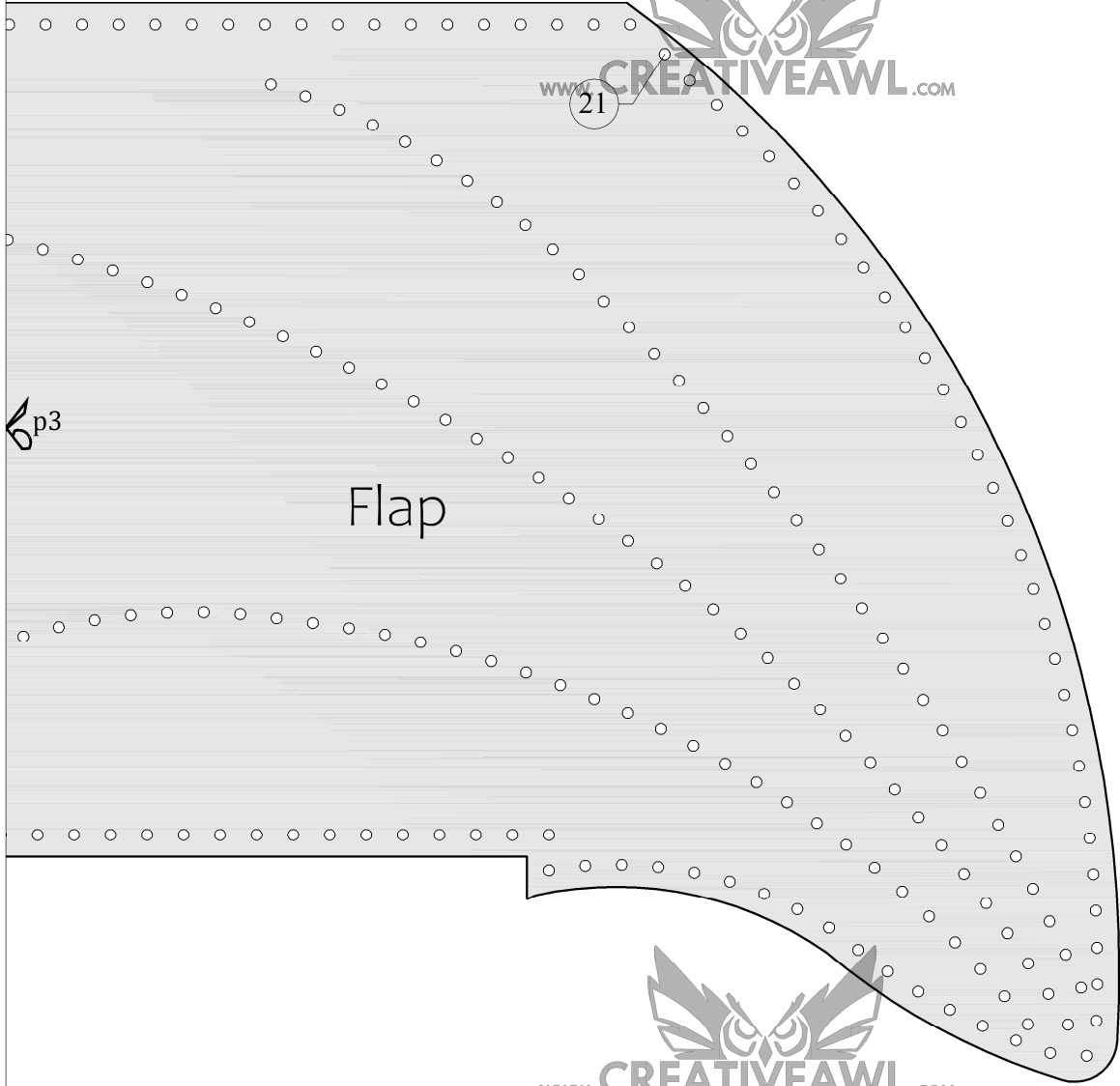

Flap

p3



www.CREATIVEAWL.COM

11 in
LETTER
8,5 in

A4

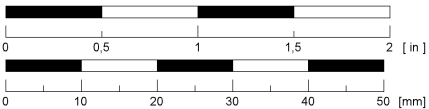

Draco nightmare
briefcase

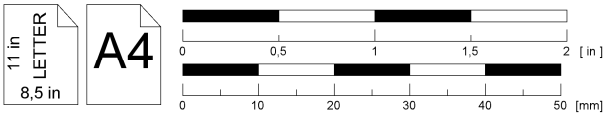
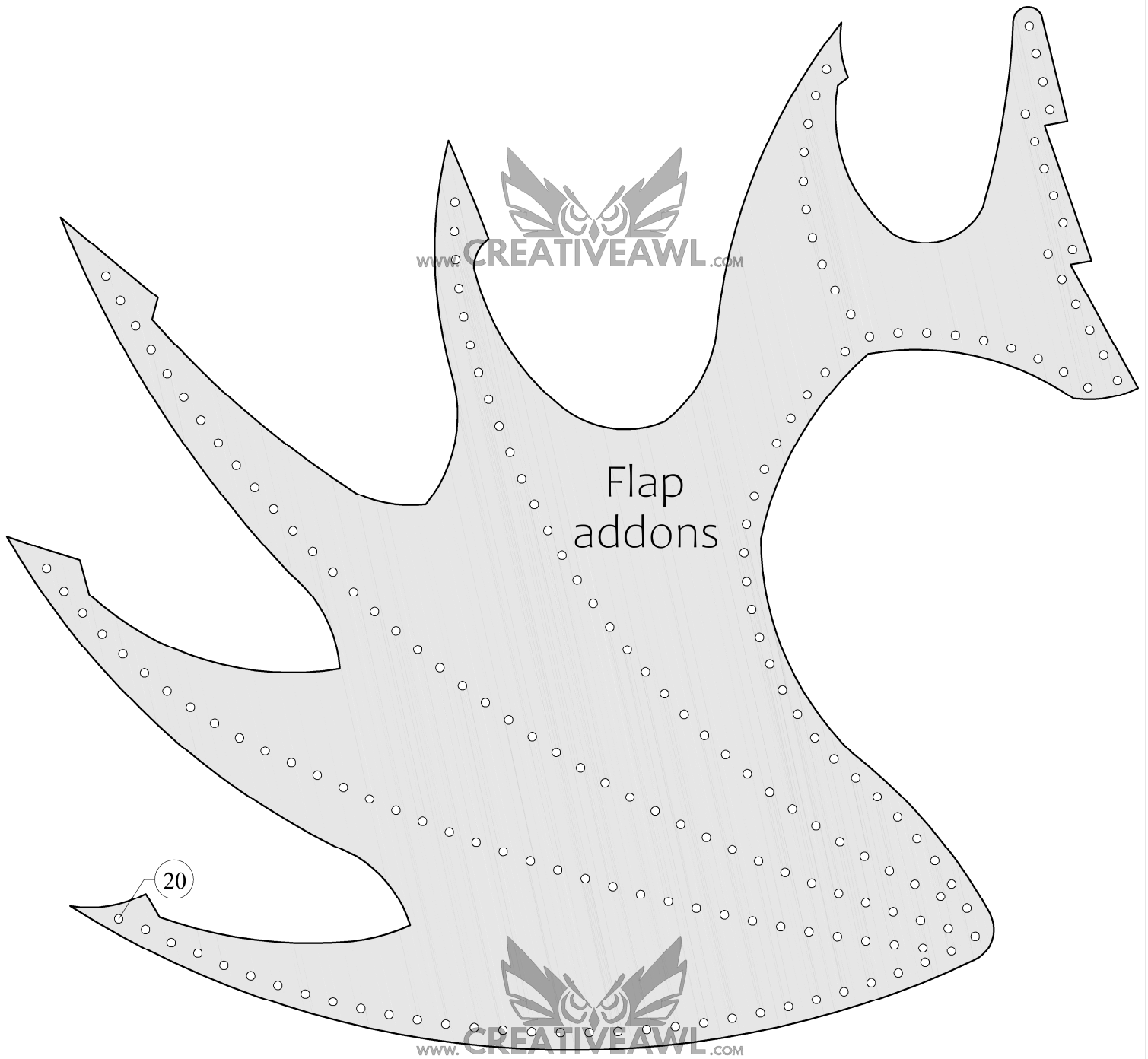

Draco nightmare
briefcase

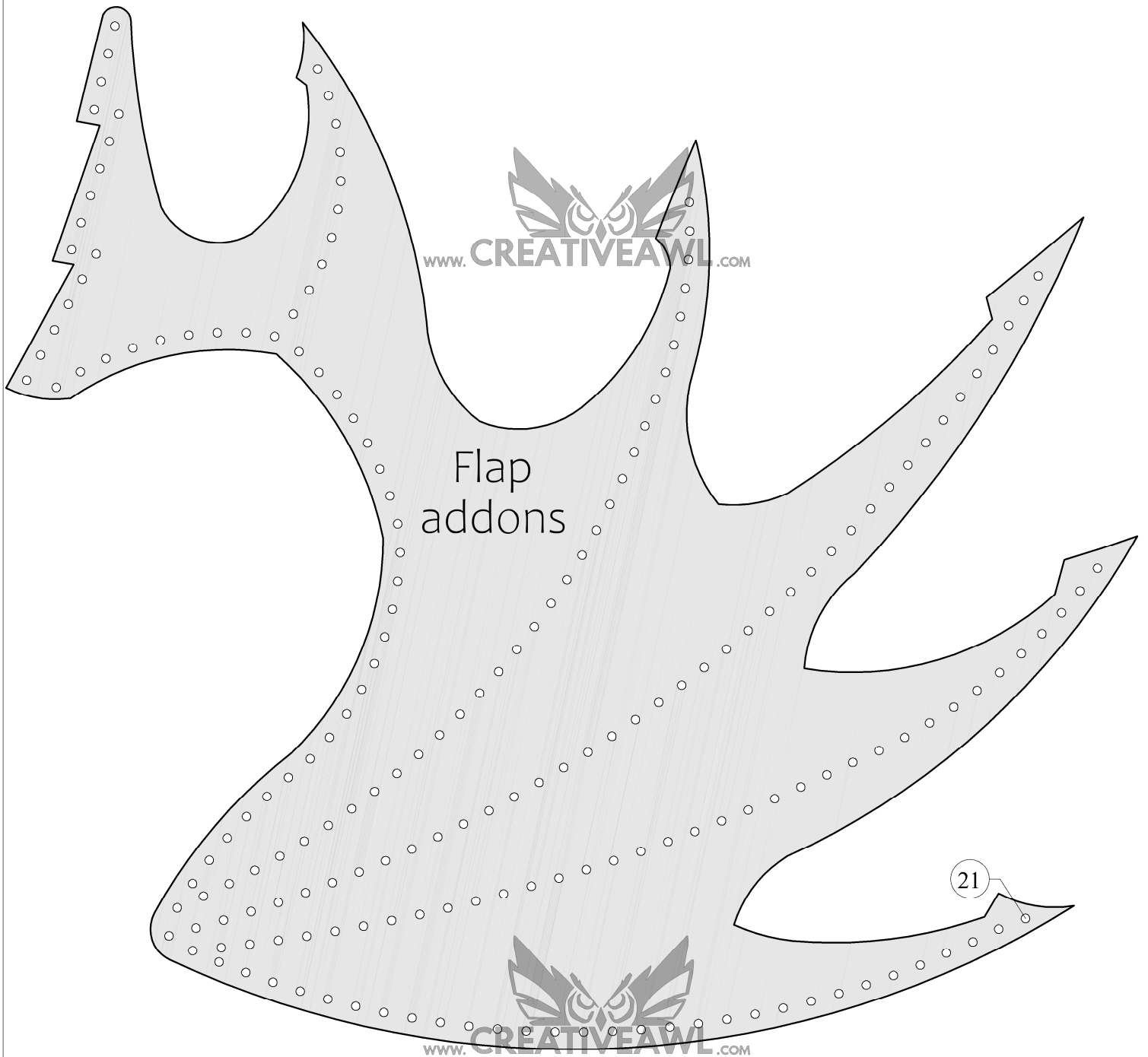

11 in
LETTER
8,5 in

A4

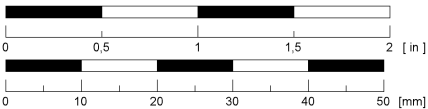

Draco nightmare
briefcase

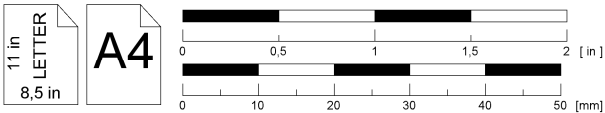
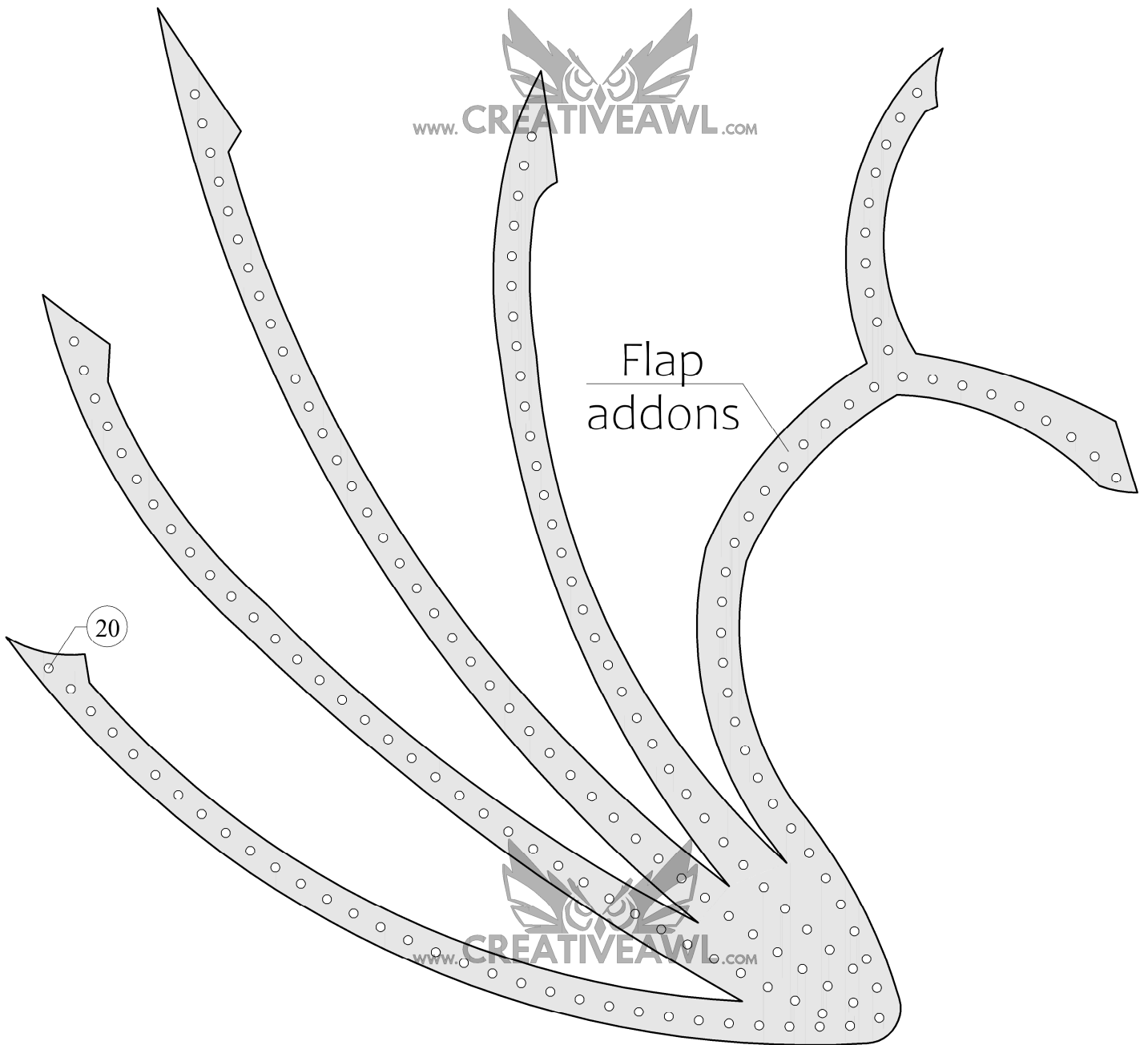

Draco nightmare
briefcase

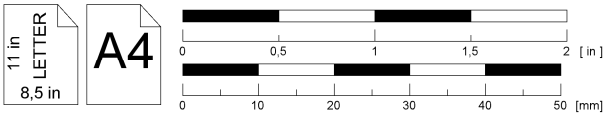
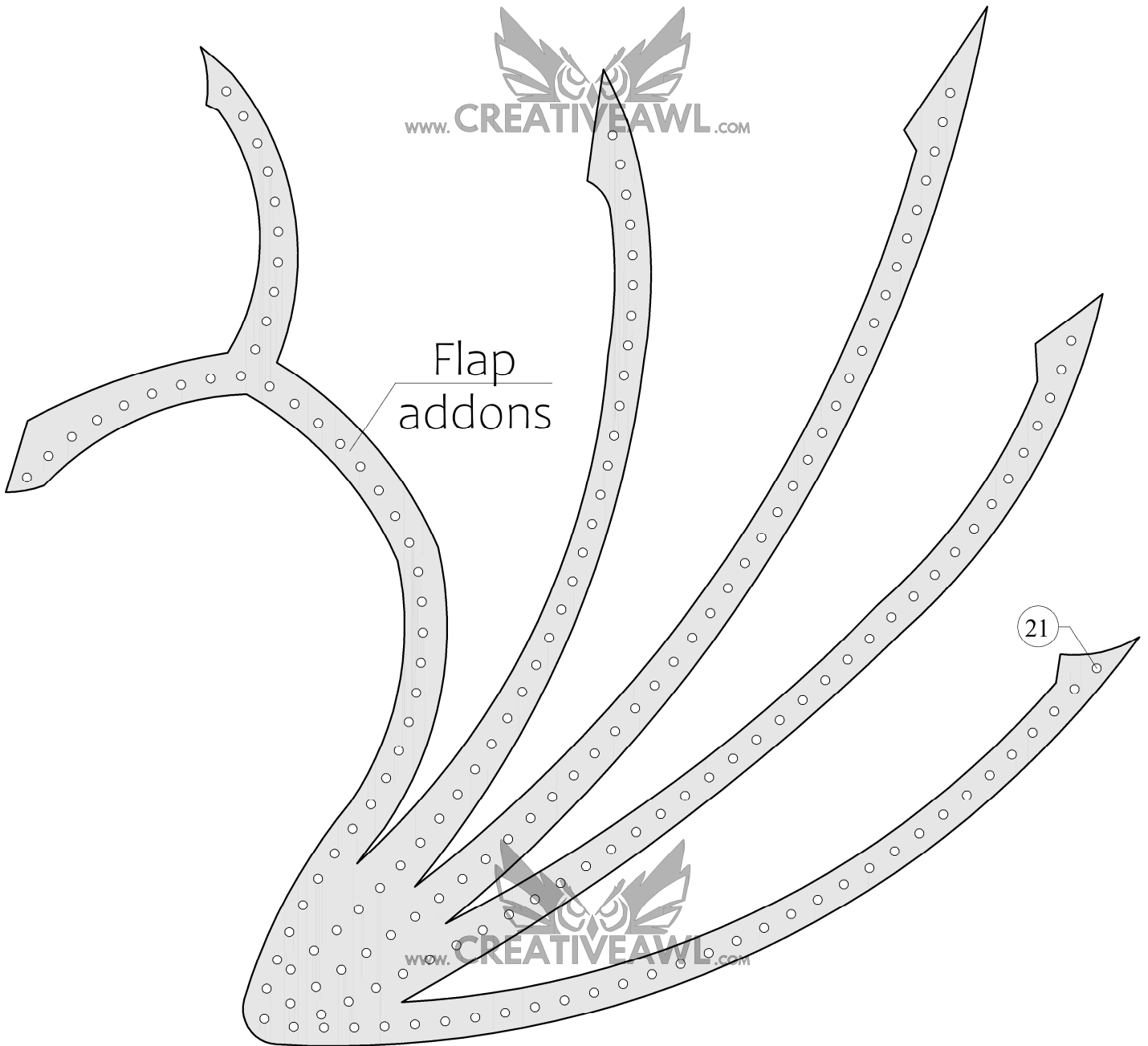

Draco nightmare briefcase

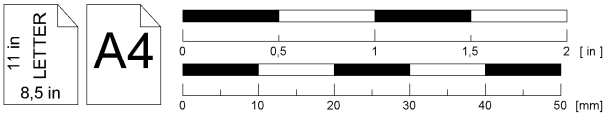

Draco nightmare
briefcase

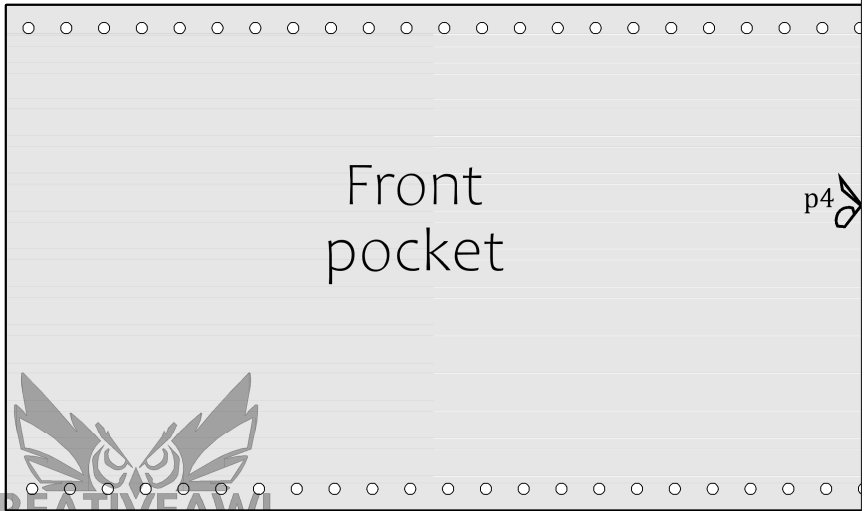

www.CREATIVEAWL.COM

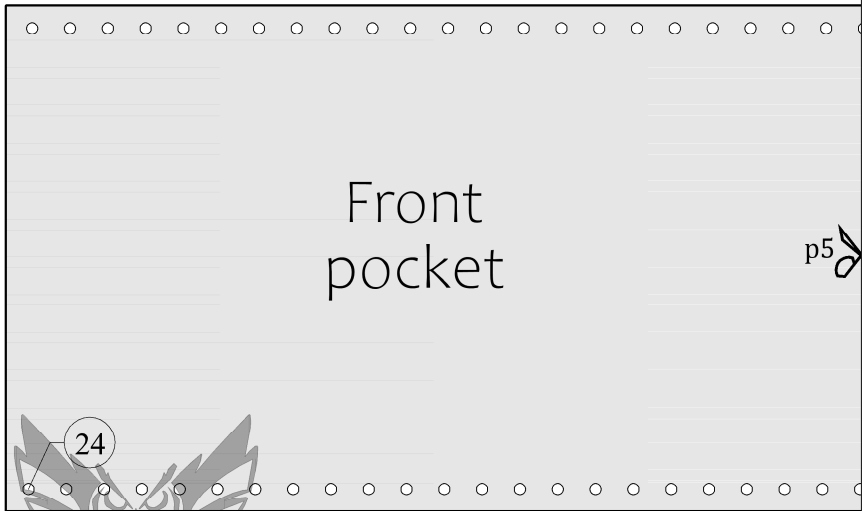

www.CREATIVEAWL.COM

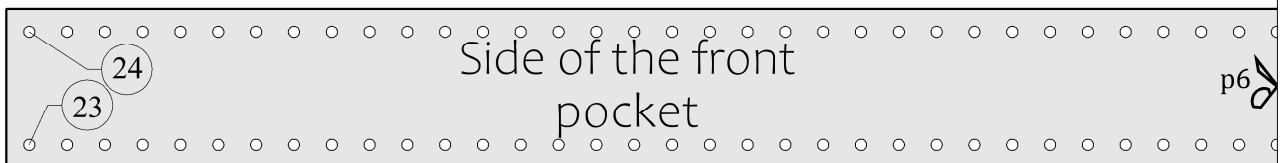

11 in
LETTER
8,5 in

A4

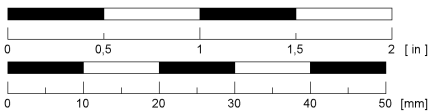

Draco nightmare
briefcase

22

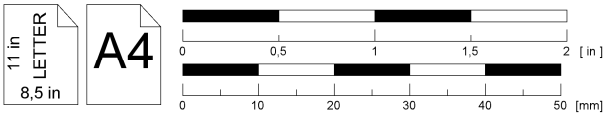
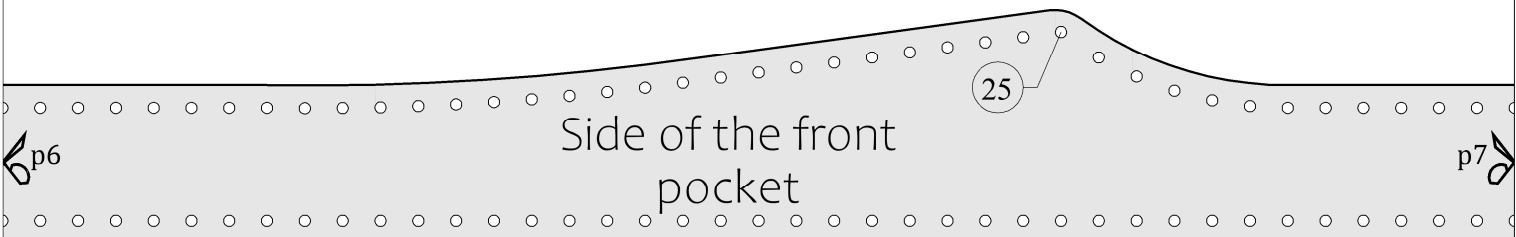
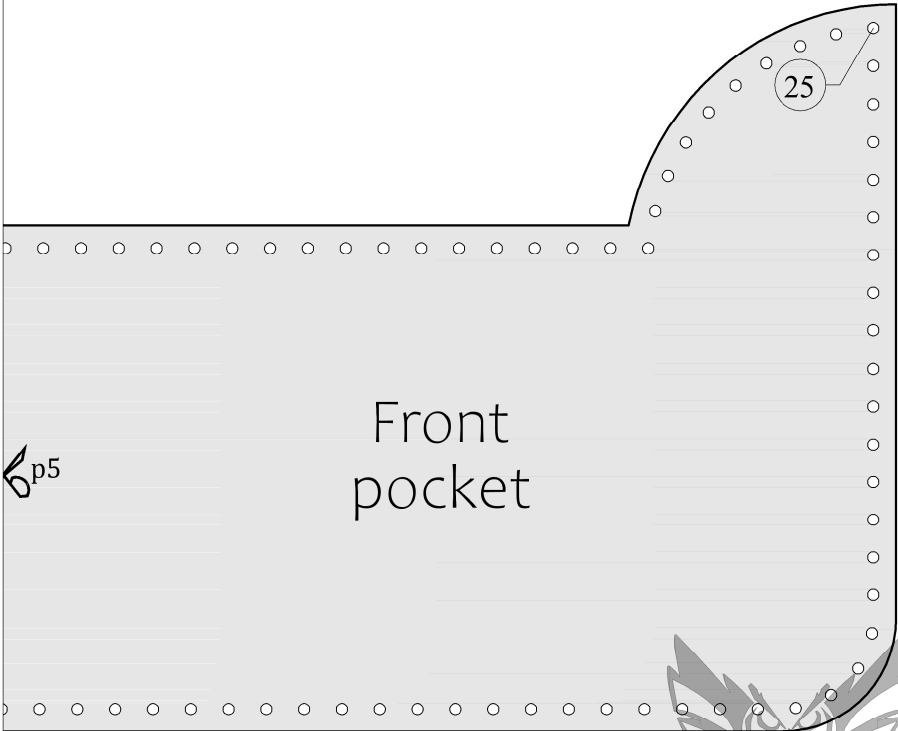
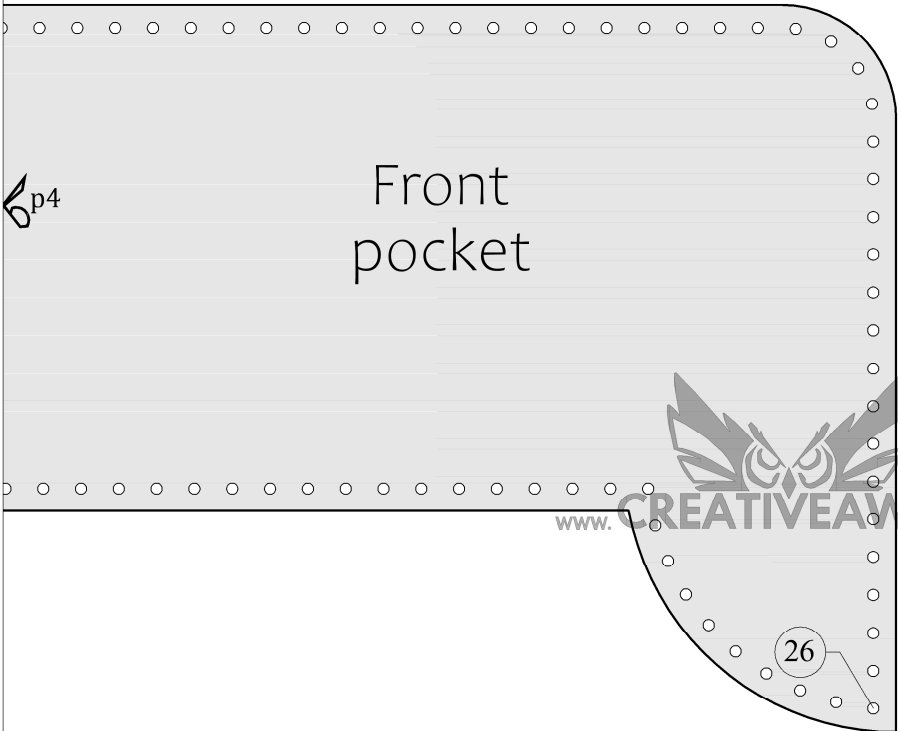

Draco nightmare
briefcase

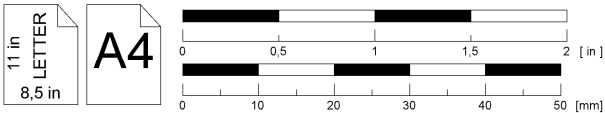
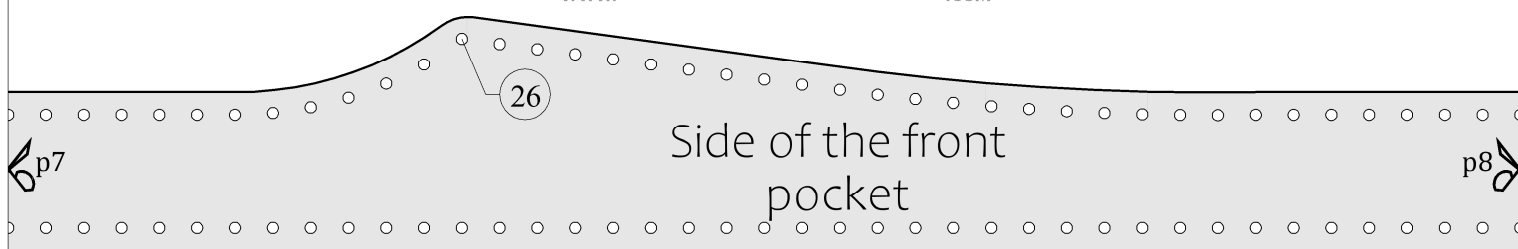
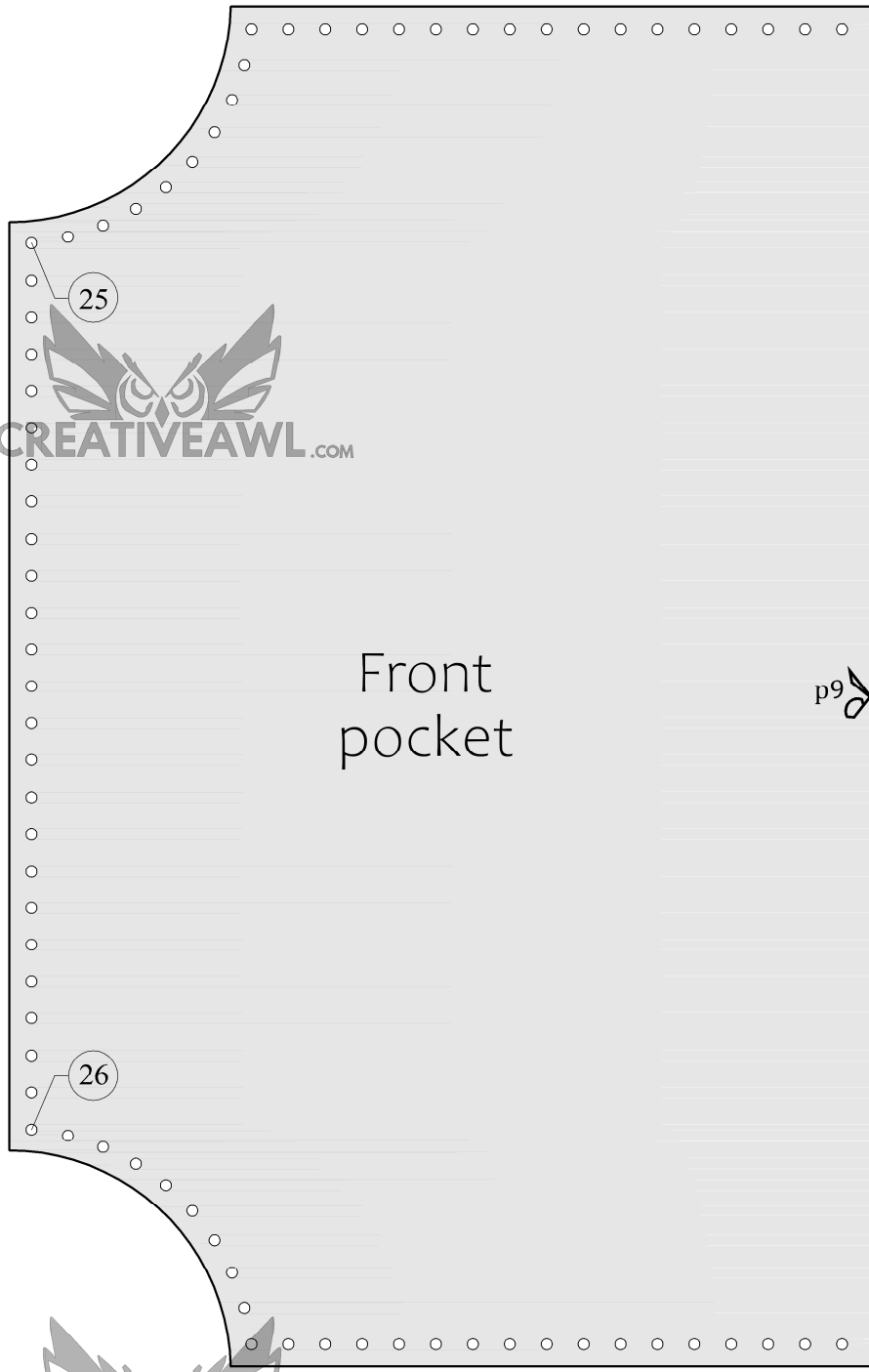

Draco nightmare
briefcase



www.CREATIVEAWL.COM

Front
pocket

p9

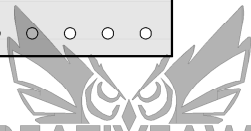

www.CREATIVEAWL.COM

Side of the front
pocket

p8

11 in
LETTER
8,5 in

A4

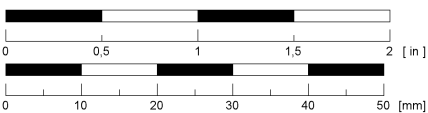

Draco nightmare
briefcase

11 in
LETTER
8,5 in

A4

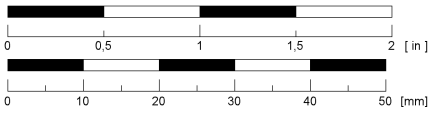

Draco nightmare briefcase



www.CREATIVEAWL.com



Front

p10



www.CREATIVEAWL.com



p11

26

11 in
LETTER
8,5 in

A4

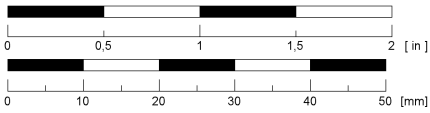

Draco nightmare briefcase

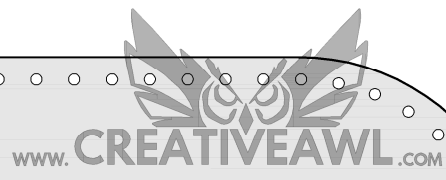
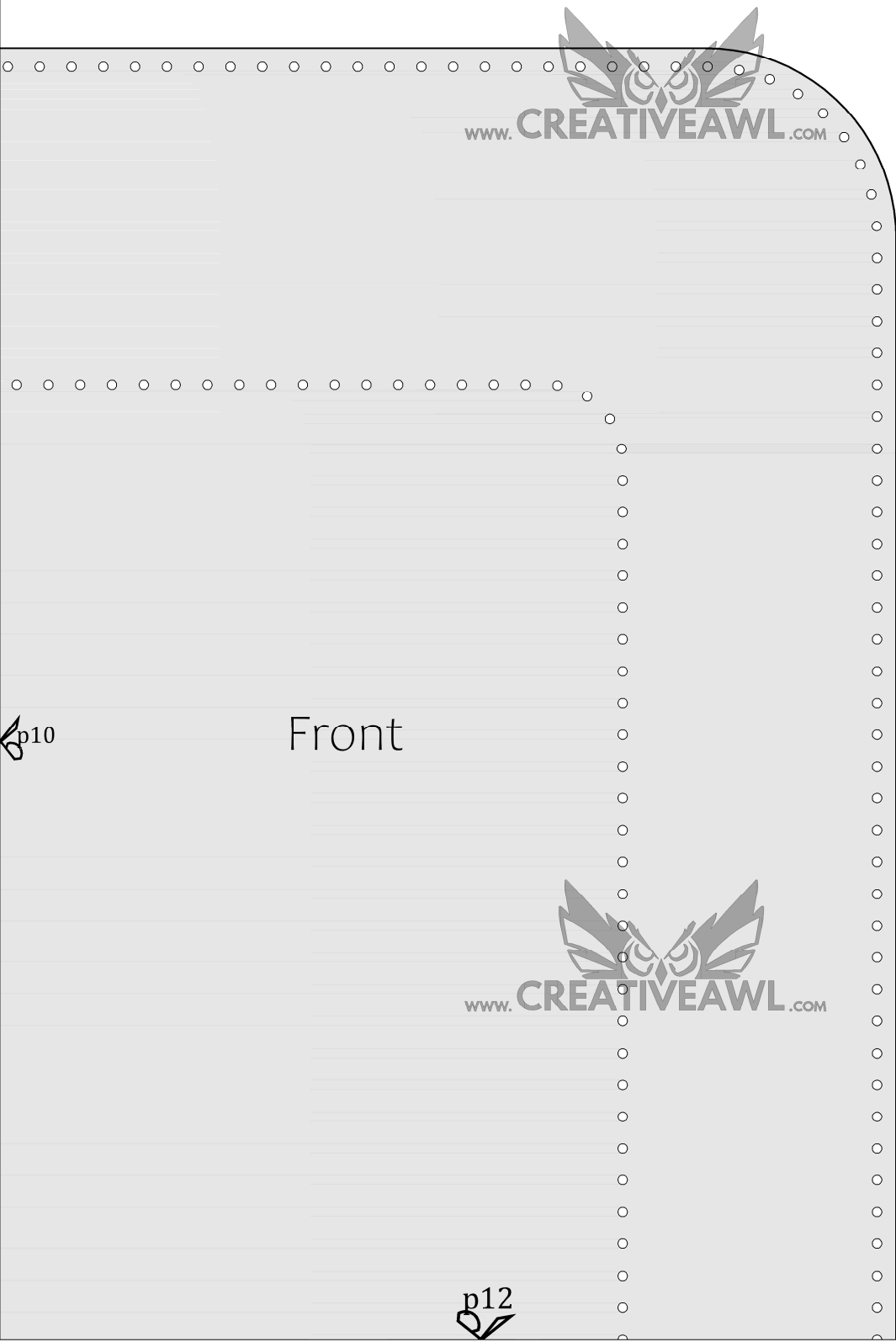

Front



p12



Front

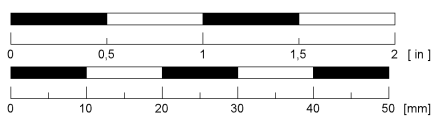
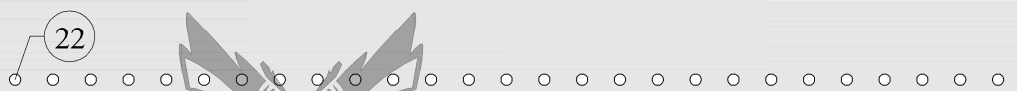

p12



www.CREATIVEAWL.COM

Front

p13



www.CREATIVEAWL.COM

11 in
LETTER
8,5 in

A4

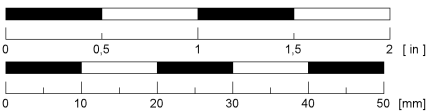

Draco nightmare
briefcase

11 in
LETTER
8,5 in

A4

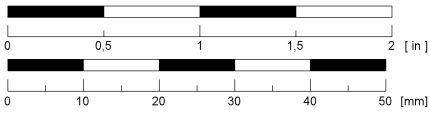

Draco nightmare briefcase

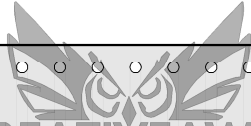

www.CREATIVEAWL.COM



Inside pocket

p14



www.CREATIVEAWL.COM

p15

30

11 in
LETTER
8,5 in

A4

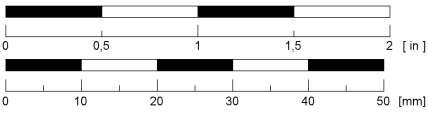

Draco nightmare briefcase



p15



www.CREATIVEAWL.COM

p17

Inside pocket

47

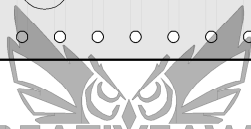

www.CREATIVEAWL.COM

11 in
LETTER
8,5 in

A4

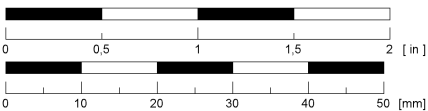

Draco nightmare
briefcase

p16



www.CREATIVEAWL.COM

p17

Inside pocket

49

48



www.CREATIVEAWL.COM

11 in
LETTER
8,5 in

A4

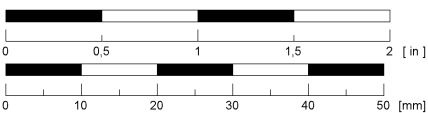

Draco nightmare
briefcase

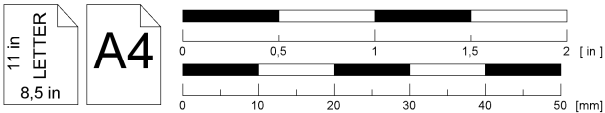
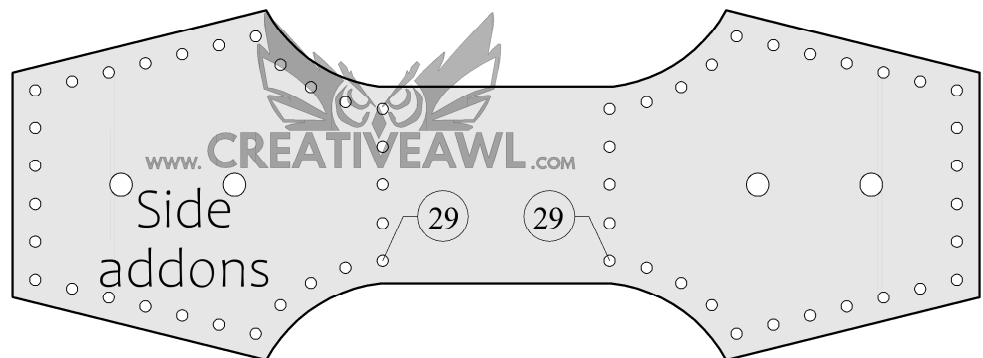
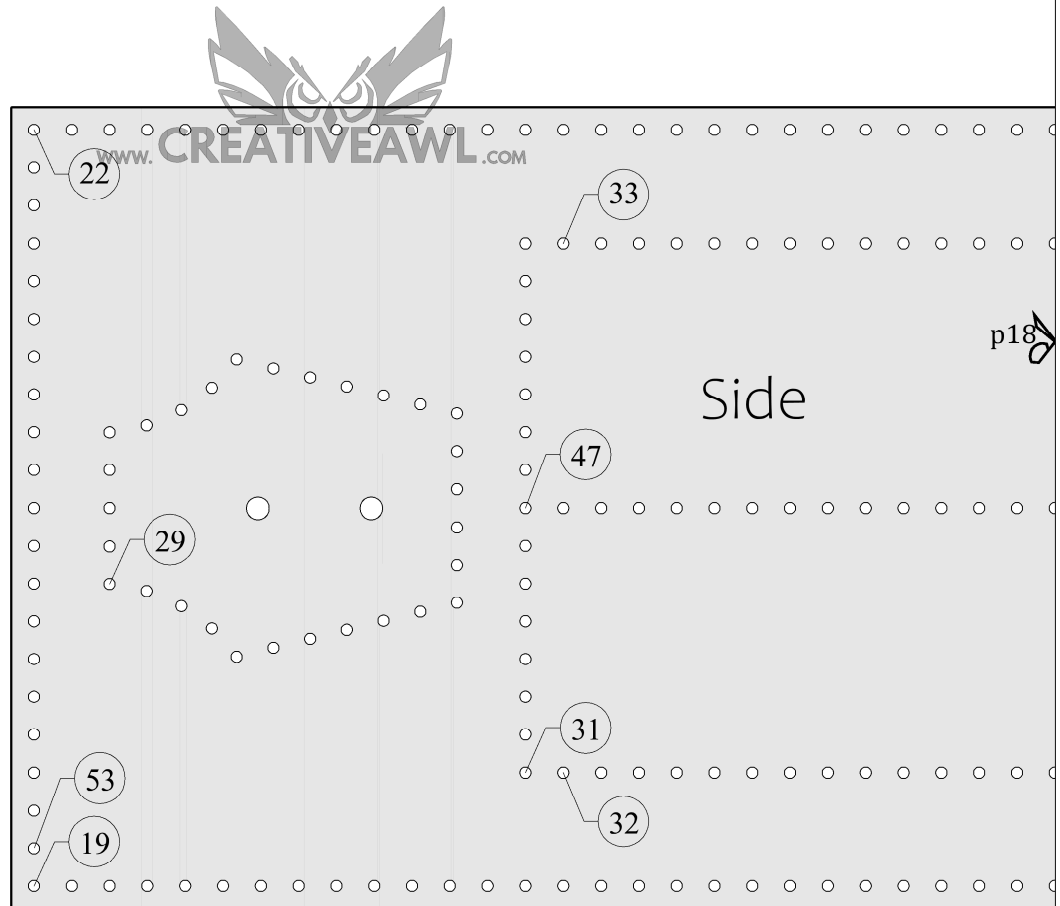
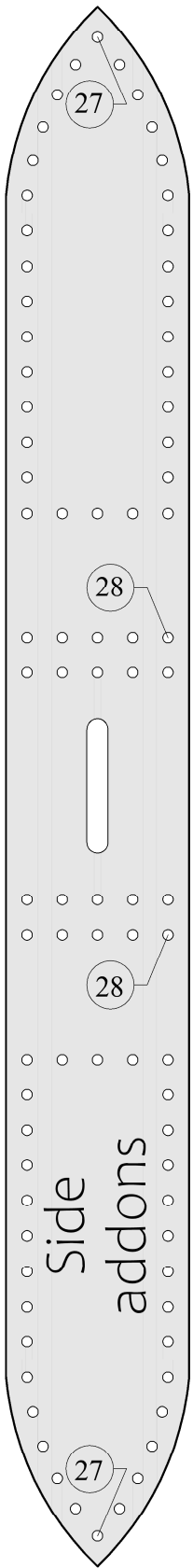

Draco nightmare
briefcase



www.CREATIVEAWL.COM

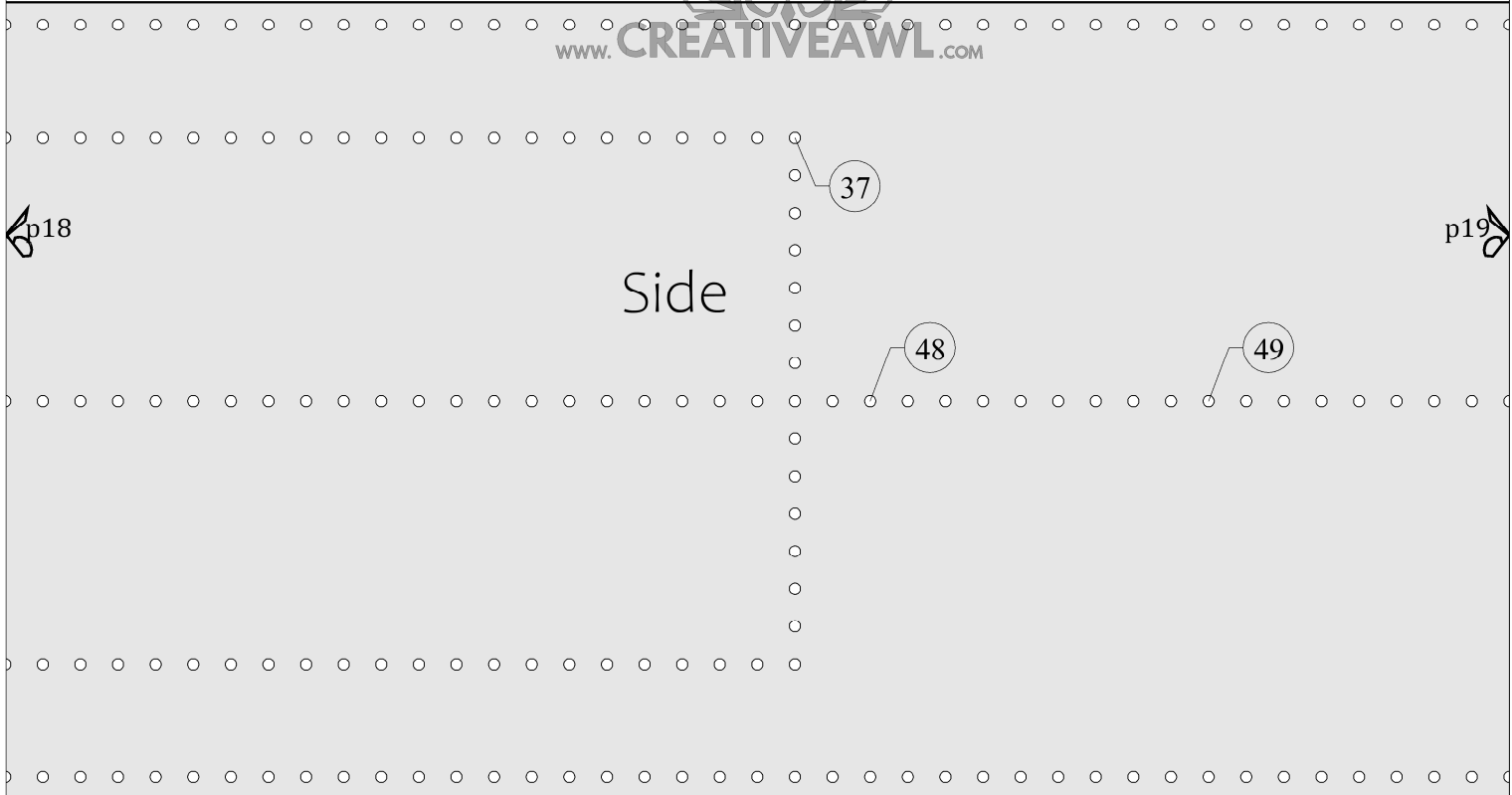

www.CREATIVEAWL.COM

11 in
LETTER
8,5 in

A4

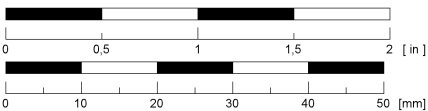

Draco nightmare
briefcase



www.CREATIVEAWL.COM

p19

p20

Side

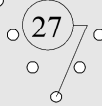

www.CREATIVEAWL.COM

11 in
LETTER
8,5 in

A4

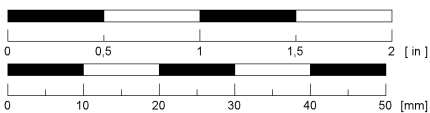

Draco nightmare
briefcase



www.CREATIVEAWL.COM

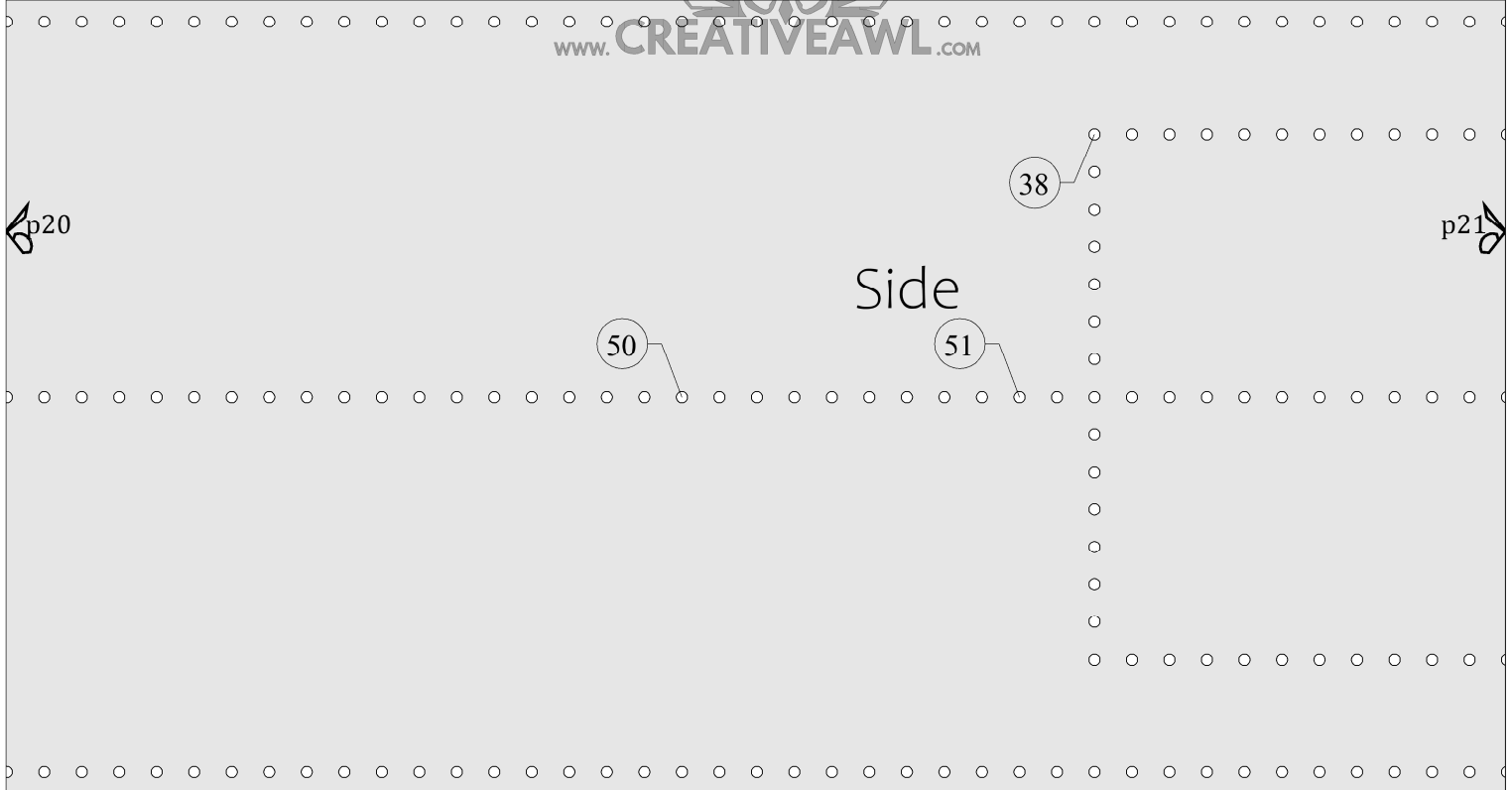

www.CREATIVEAWL.COM

11 in
LETTER
8,5 in

A4

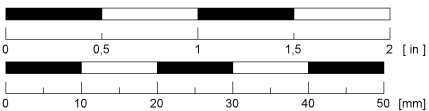

Draco nightmare
briefcase



www.CREATIVEAWL.COM

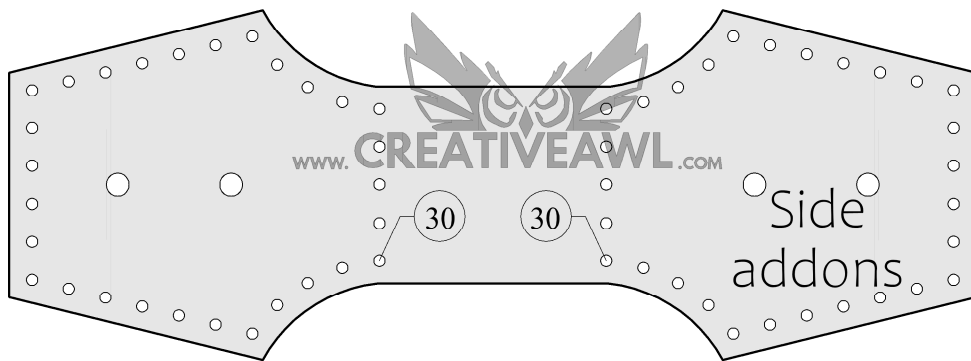
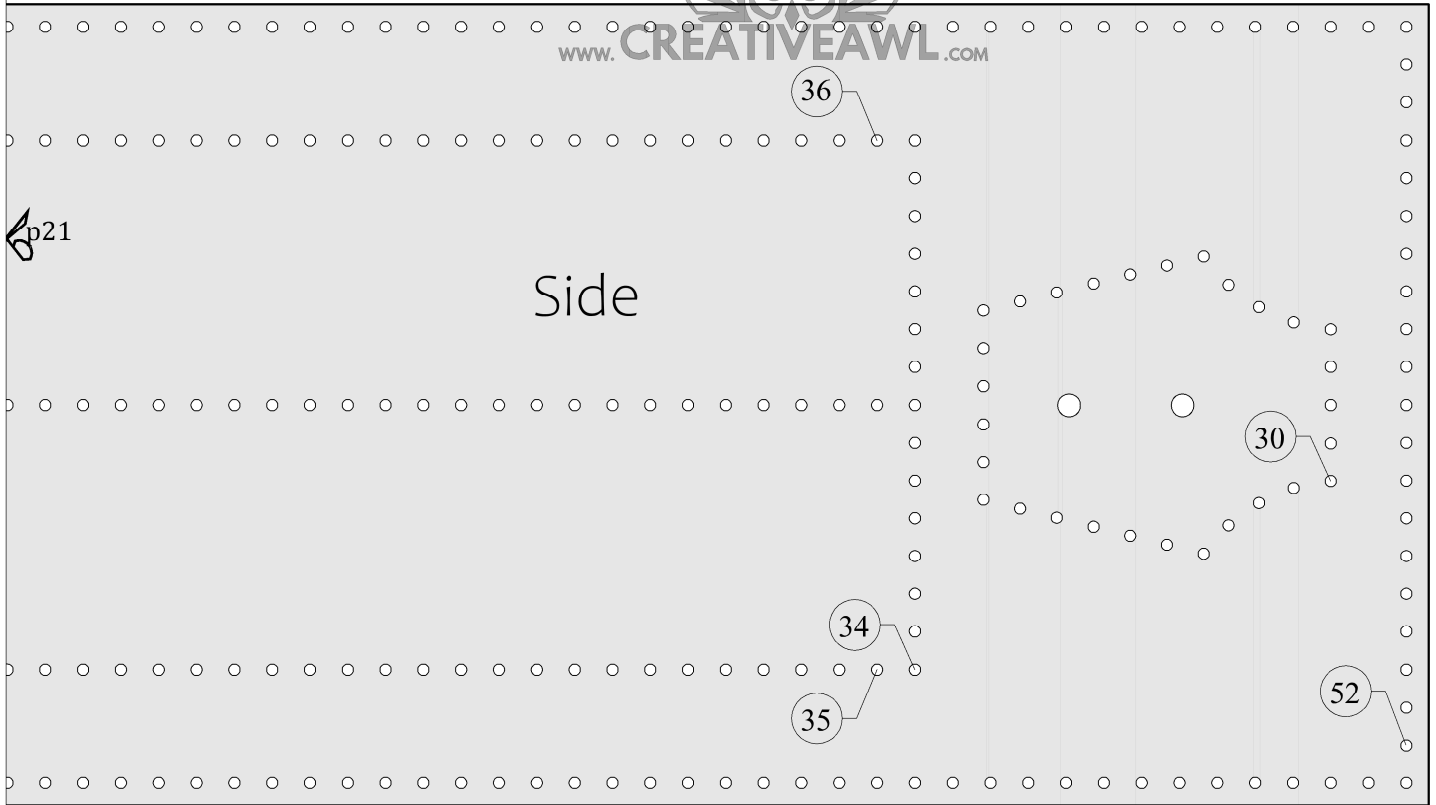

www.CREATIVEAWL.COM

11 in
LETTER
8,5 in

A4

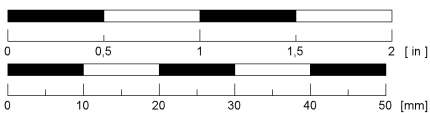

Draco nightmare
briefcase

11 in
LETTER
8,5 in

A4

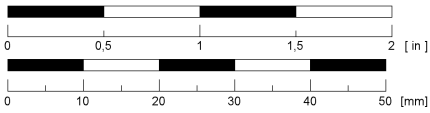

Draco nightmare briefcase



11 in
LETTER
8,5 in

A4

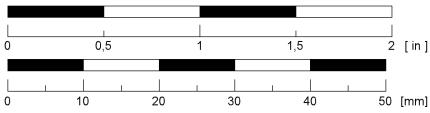

Draco nightmare briefcase

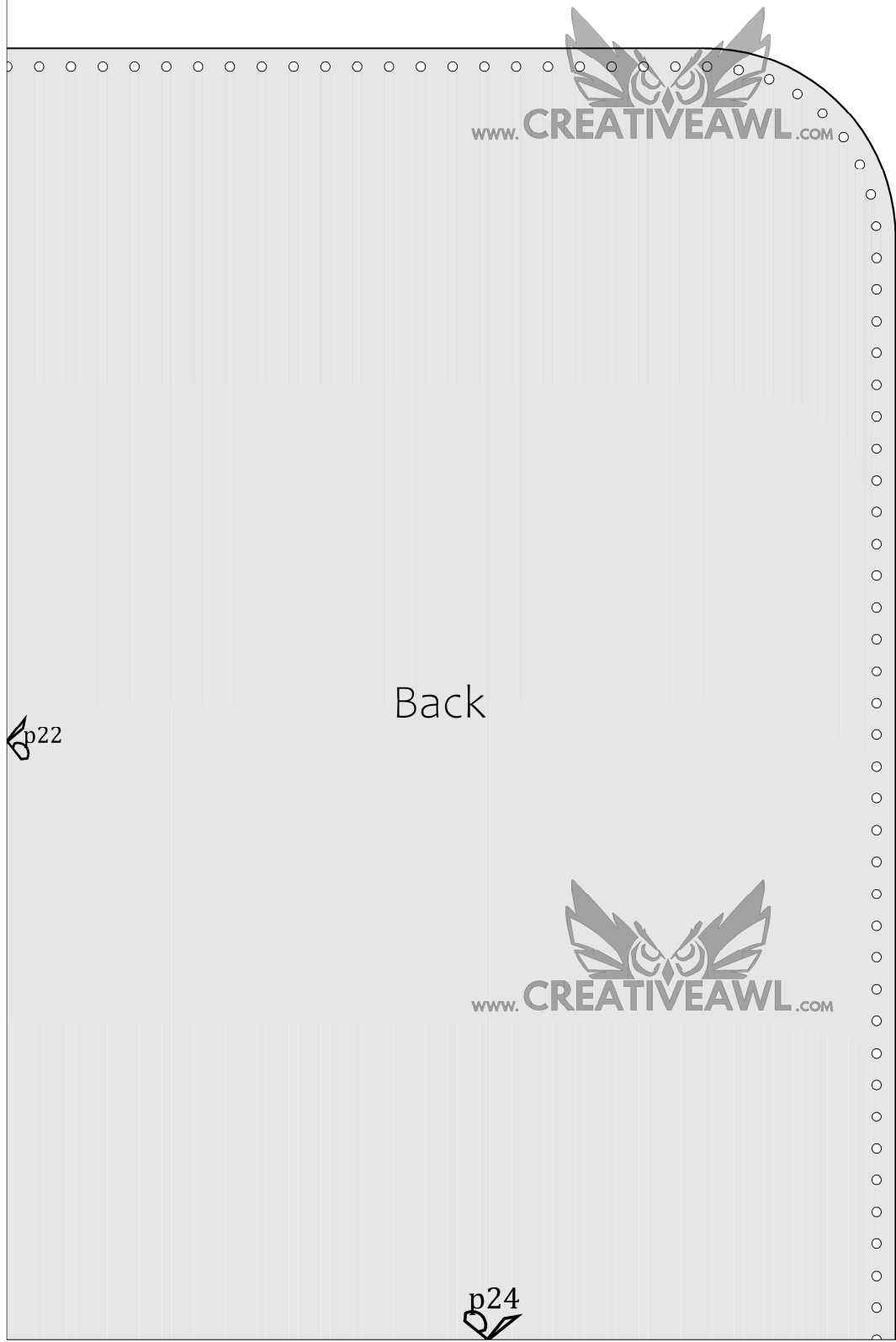

p22

Back



p24

p23



www.CREATIVEAWL.COM

Back

p25

16



www.CREATIVEAWL.COM

11 in
LETTER
8,5 in

A4

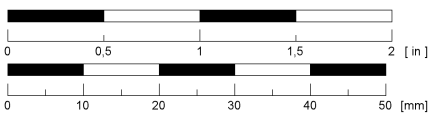

Draco nightmare
briefcase

p24



p25

Back



11 in
LETTER
8,5 in

A4

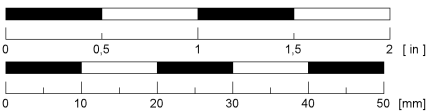

Draco nightmare
briefcase

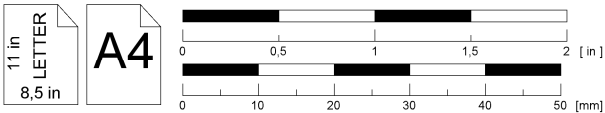
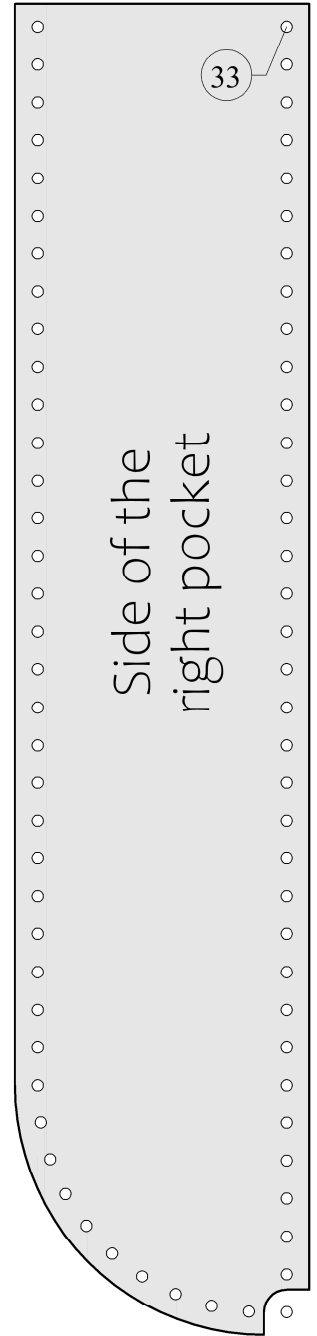
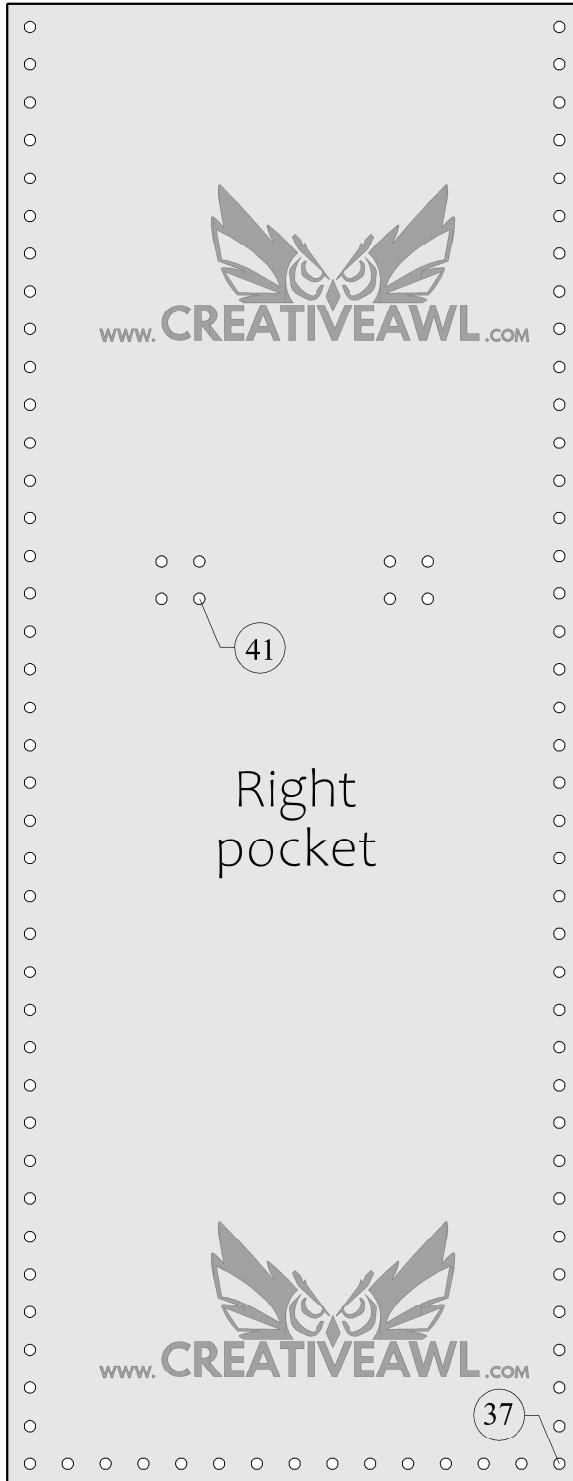
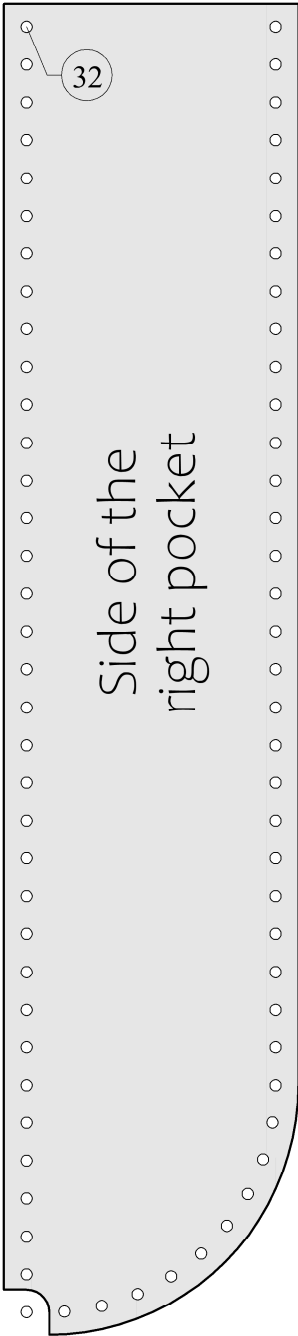

Draco nightmare
briefcase

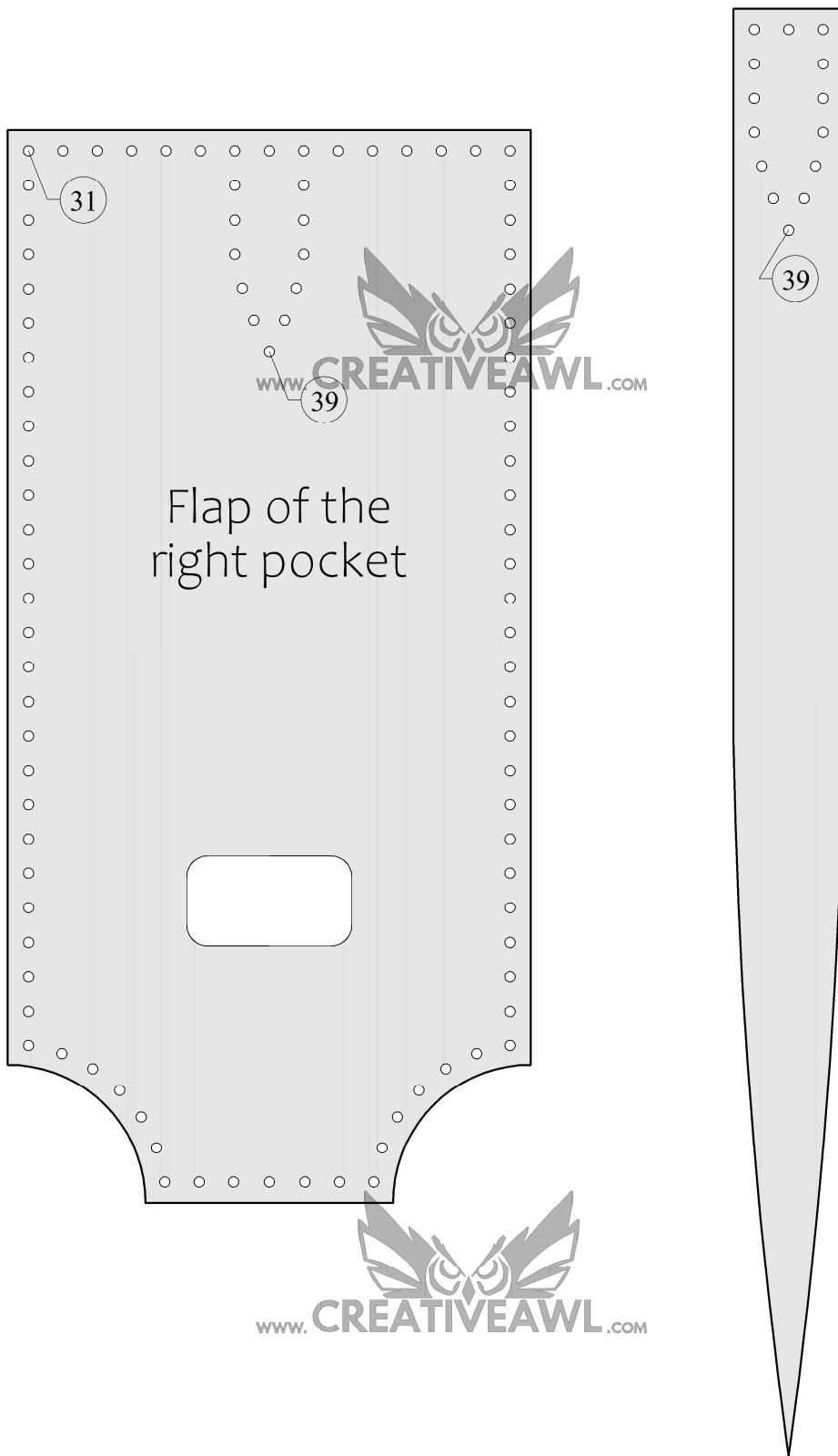

Flap of the
right pocket

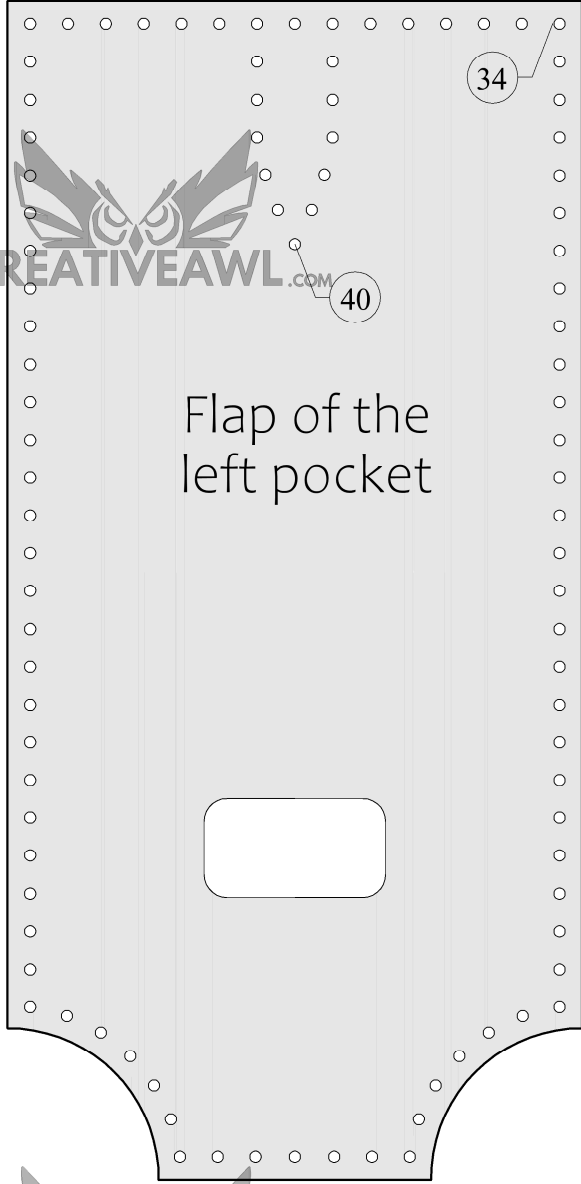

www.CREATIVEAWL.COM

www.CREATIVEAWL.COM

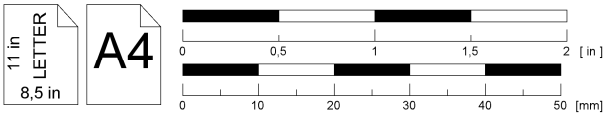

Draco nightmare
briefcase

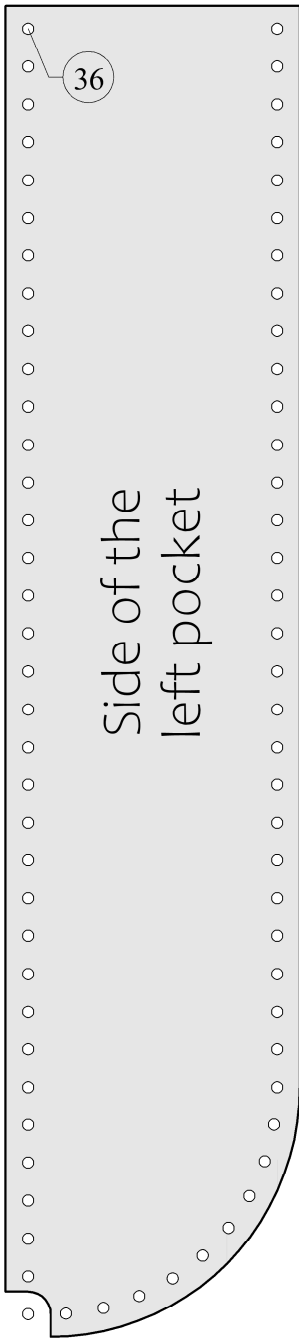
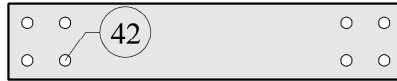

Side of the
left pocket

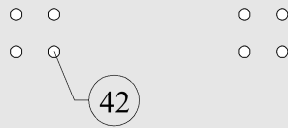
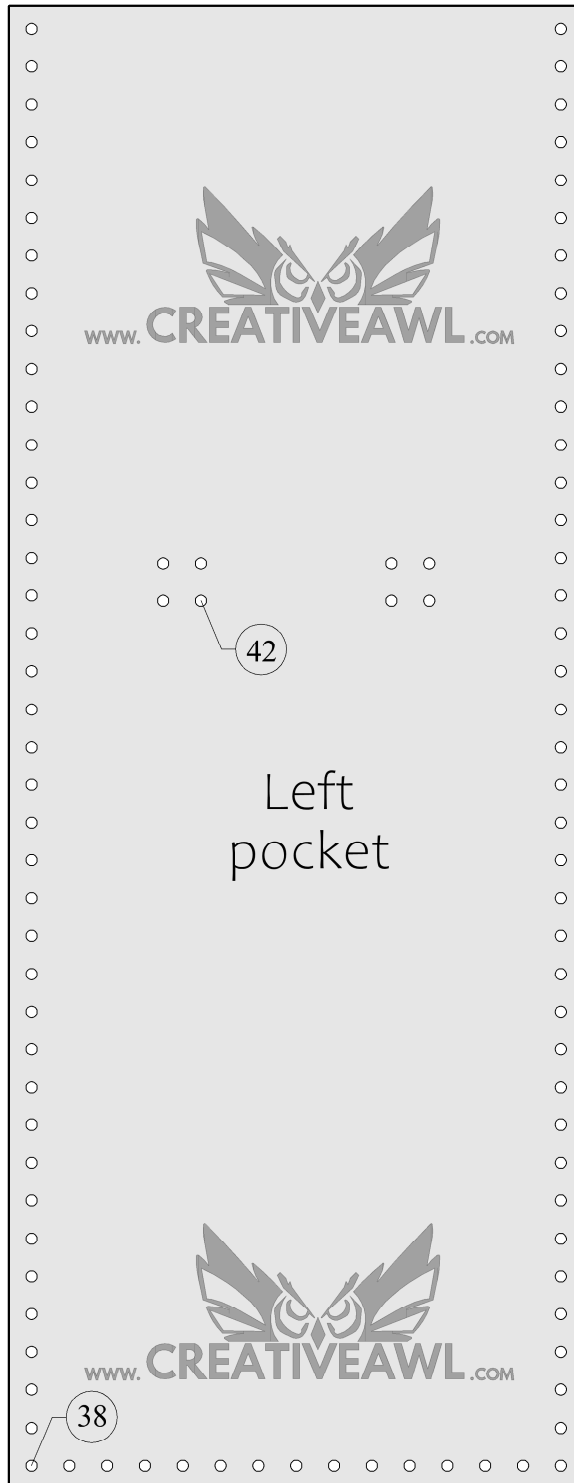

Left
pocket

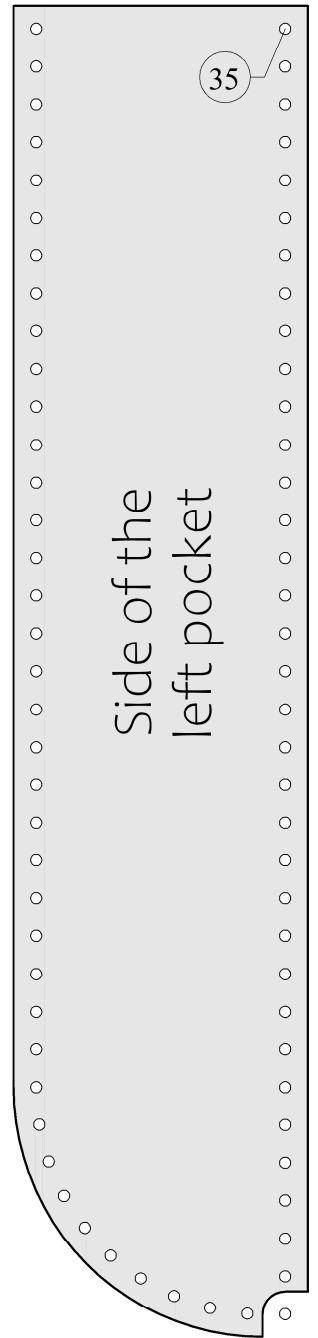

Side of the
left pocket

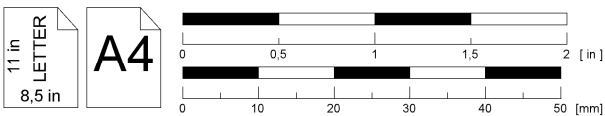

Draco nightmare
briefcase

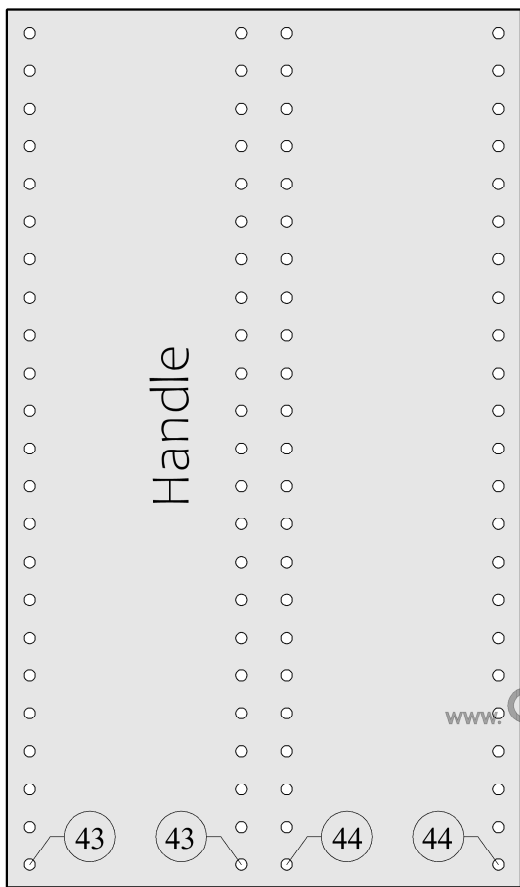
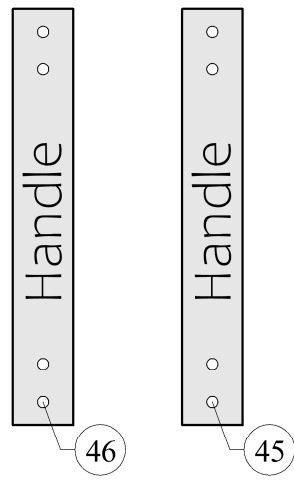
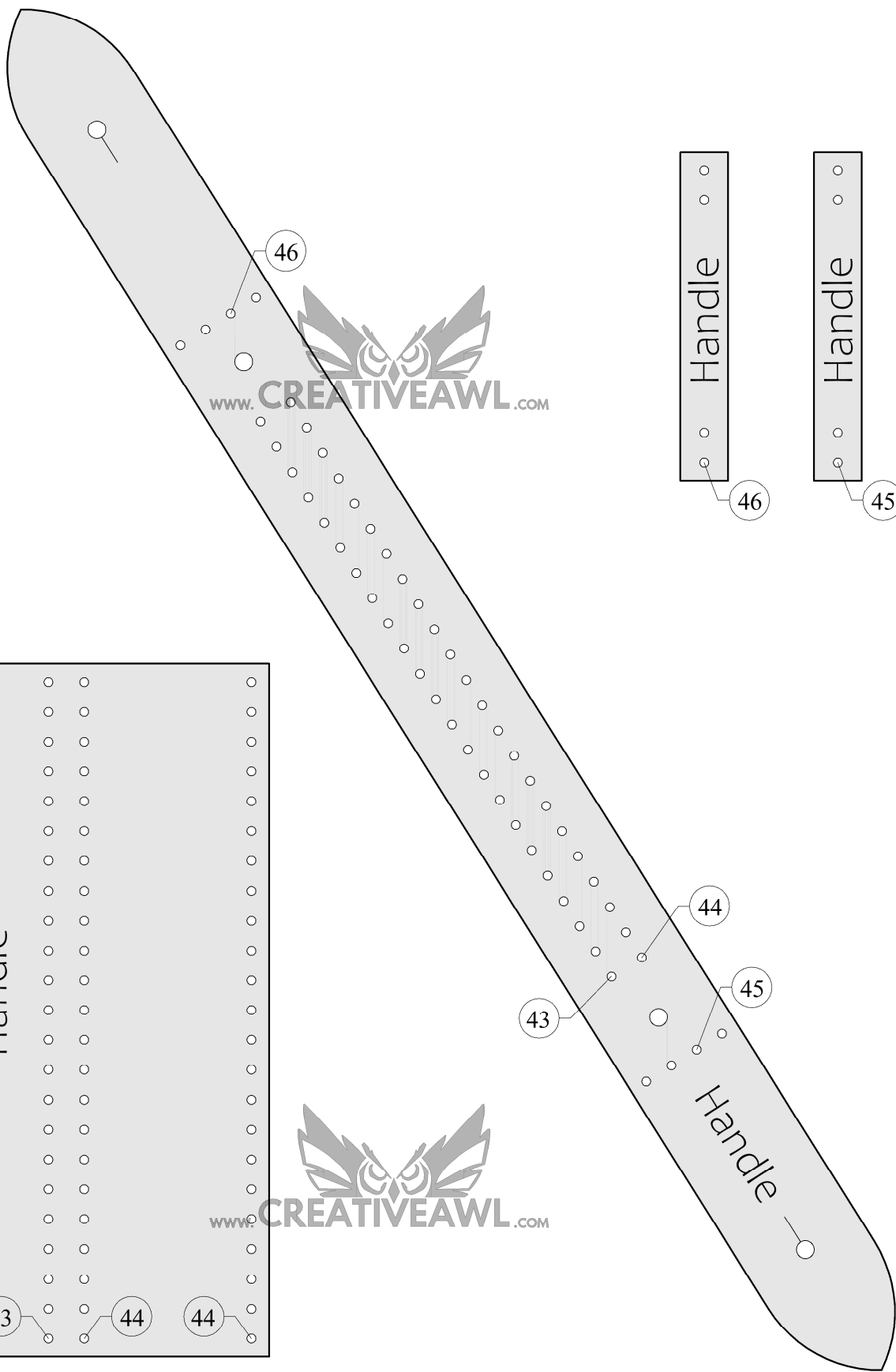

www.CREATIVEAWL.COM

www.CREATIVEAWL.COM

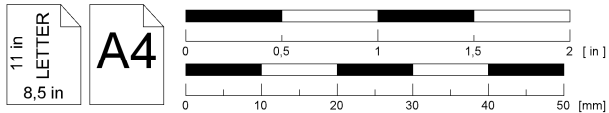

Draco nightmare
briefcase

