



CREATIVE AWL
**ORIGINAL
PATTERNS**



Dragonfly Bag



 **YouTube**
VIDEO TUTORIAL

**EASY TO
PRINT**
PDF >>>>
PATTERN

LET'S GO!

& don't forget check out our free patterns!



1



PRINT THE PATTERN

- Open your pattern in Adobe Acrobat Reader, or any web browser.
- Every page has a measure - check does it fit.
- Every printed page **MUST HAVE** a border around! If doesn't - move paper left/ right and print again

2



FOLLOW VIDEO INSTRUCTIONS

- Video tutorial:
<https://youtu.be/BafJ-Ec14aY>
- Cutting patterns:
https://www.youtube.com/watch?v=2TNUI_TIk64



3



GIVE A SMILE TO OTHER PEOPLE !

- Give a ready product to you family or friend.
Give them a smile :)))
- Also Check www.CreativeAwl.com for more patterns

4



JOIN OUR FB GROUP

- Go there to share your work. Also get more DIY&ideas. We will support you & answer all questions.
<https://www.facebook.com/groups/CreativeAwlPatterns/>



YOU NEED

MATERIALS

- **3.2 SQFT (0.3 SQM)
(2MM) OF LEATHER**
- **2X 20MM BUCKLES**
- **1 X 20MM O-RING**
- **6 RIVETS**
- **0.8MM WAXED THREAD**

TOOLS

- **SHARP KNIFE**
- **1.2 - 1.5 MM HOLE PUNCHER /
PRICKING IRONS OR AWL**
- **HAMMER**
- **2 NEEDLES**
- **PAPER TAPE**
- **A HOME PRINTER**

SHARE YOUR WORK

[https://www.facebook.com/groups/
CreativeAwlPatterns](https://www.facebook.com/groups/CreativeAwlPatterns)

Dragonfly bag:

pages 4 - 12

-The number in the circle shows which holes are to be connected. Example: ①

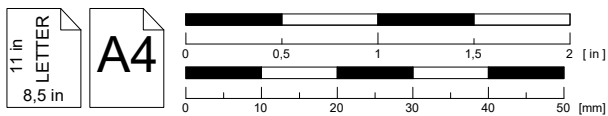
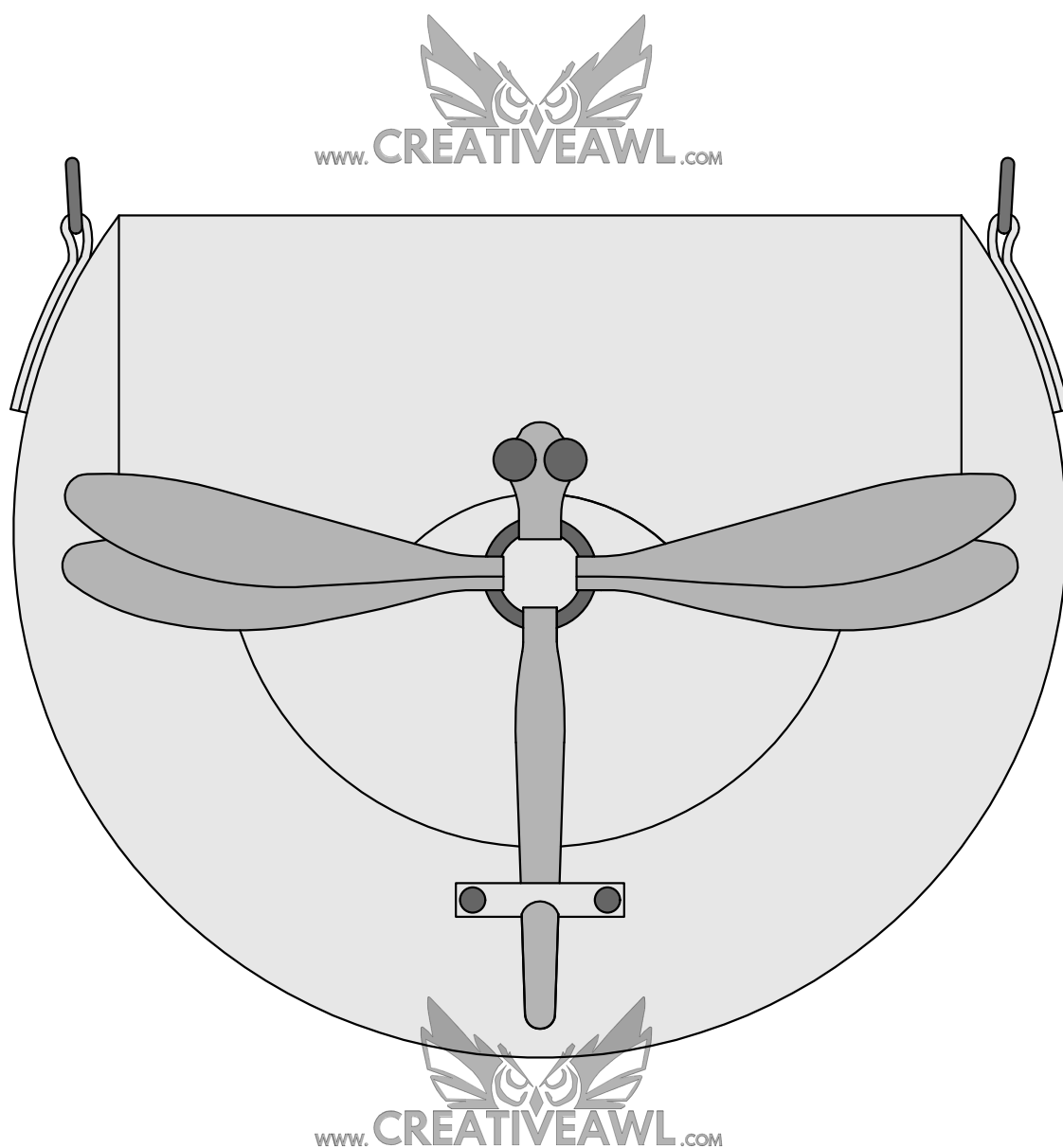

Sketch drawing

Leather needed for Dragonfly bag: about 0,29 m2

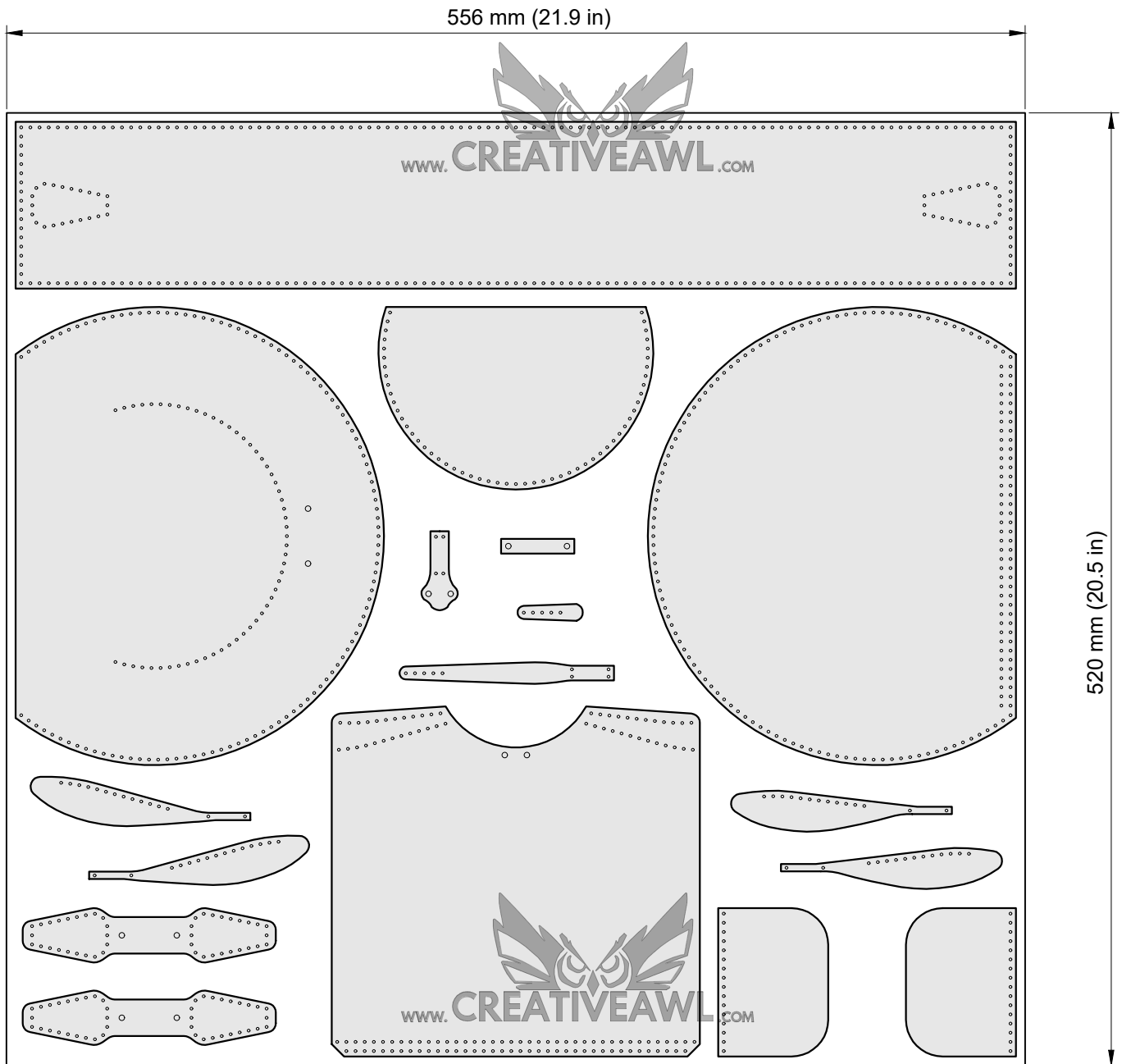

Sketch drawing
Bill of materials



www.CREATIVEAWL.COM

Front

p1

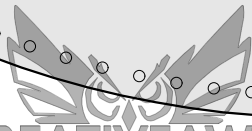

www.CREATIVEAWL.COM

11 in
LETTER
8,5 in

A4

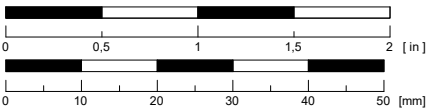

Dragonfly bag

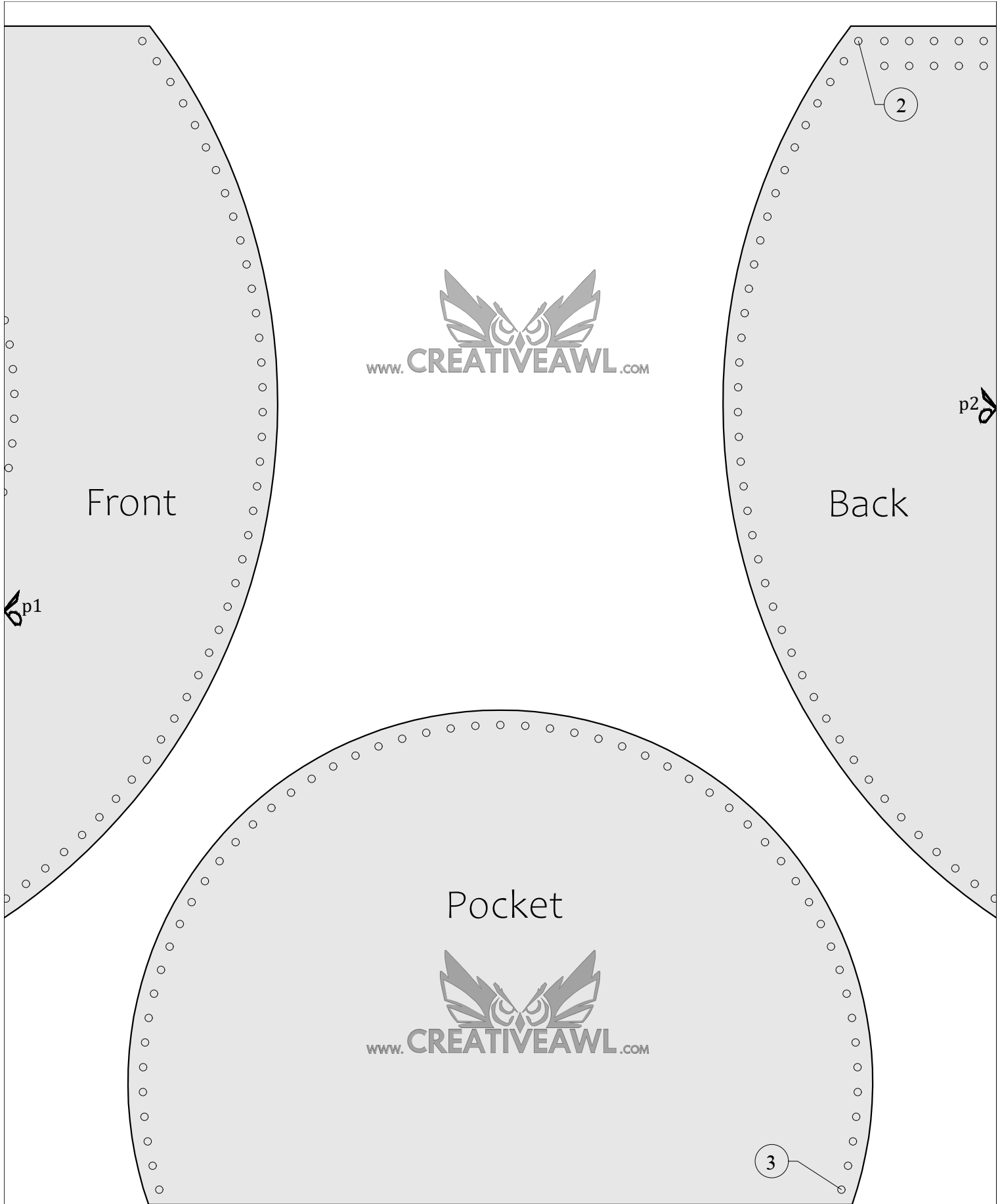

11 in
LETTER
8,5 in

A4

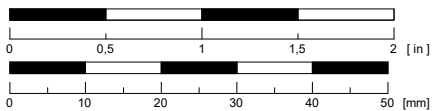

Dragonfly bag

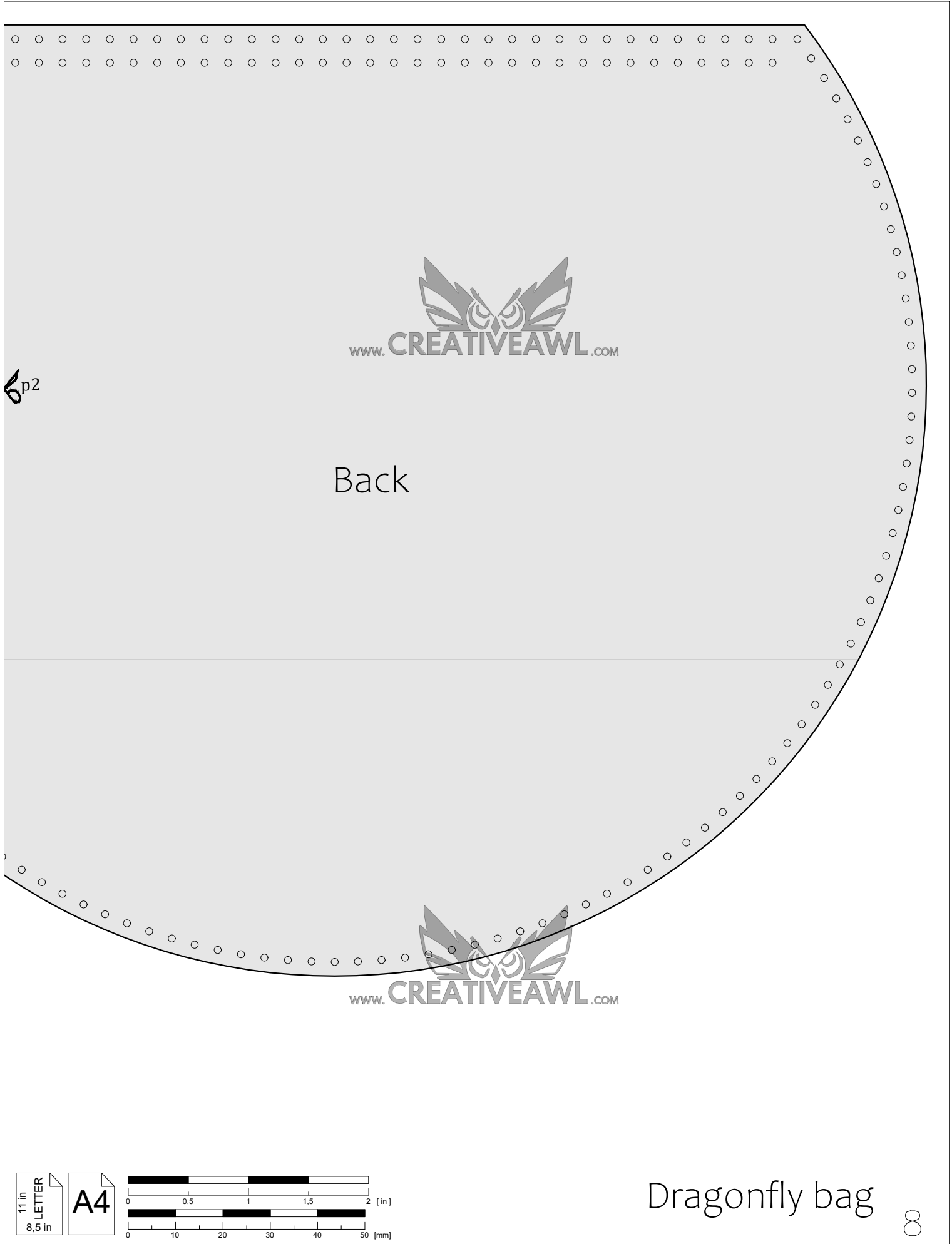

p2

Back

www.CREATIVEAWL.COM

www.CREATIVEAWL.COM

11 in
LETTER
8,5 in

A4

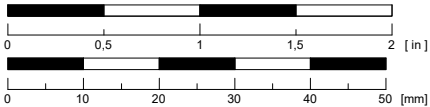

Dragonfly bag

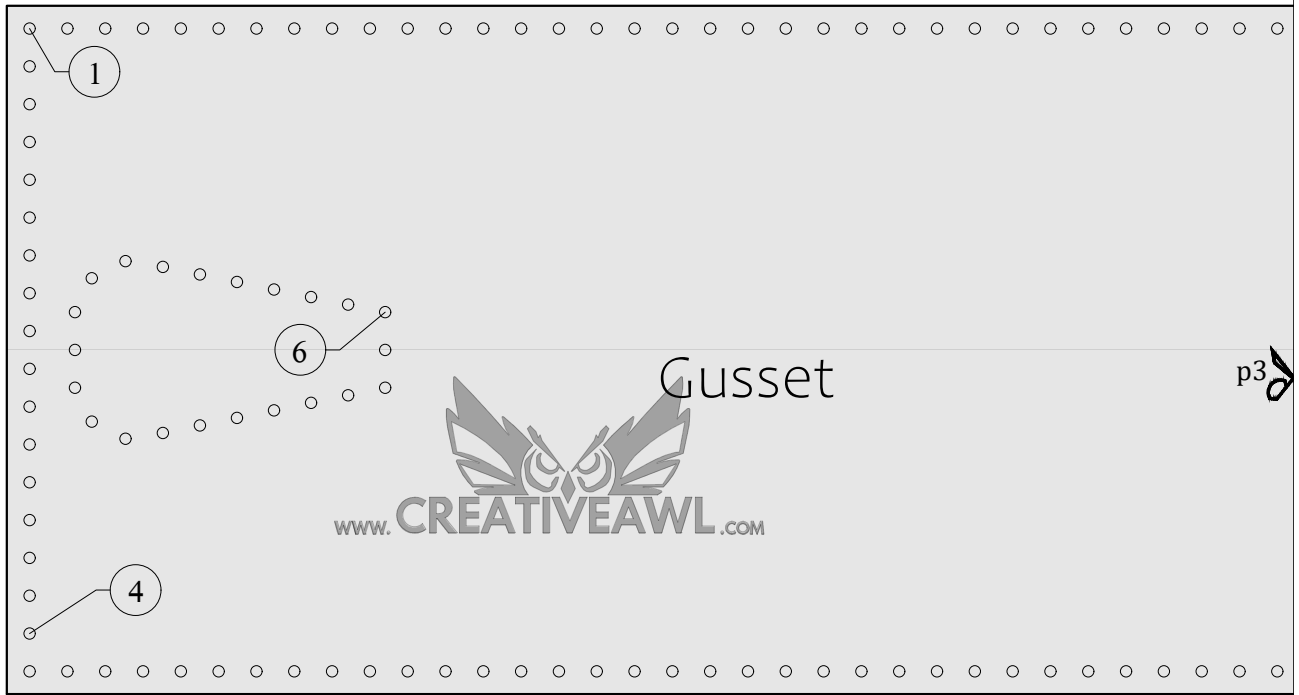

11 in
8,5 in
LETTER

A4

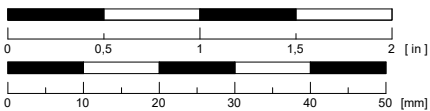

Dragonfly bag

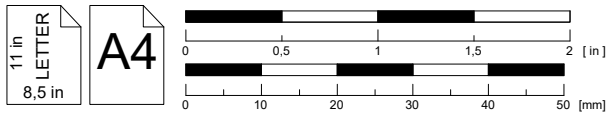

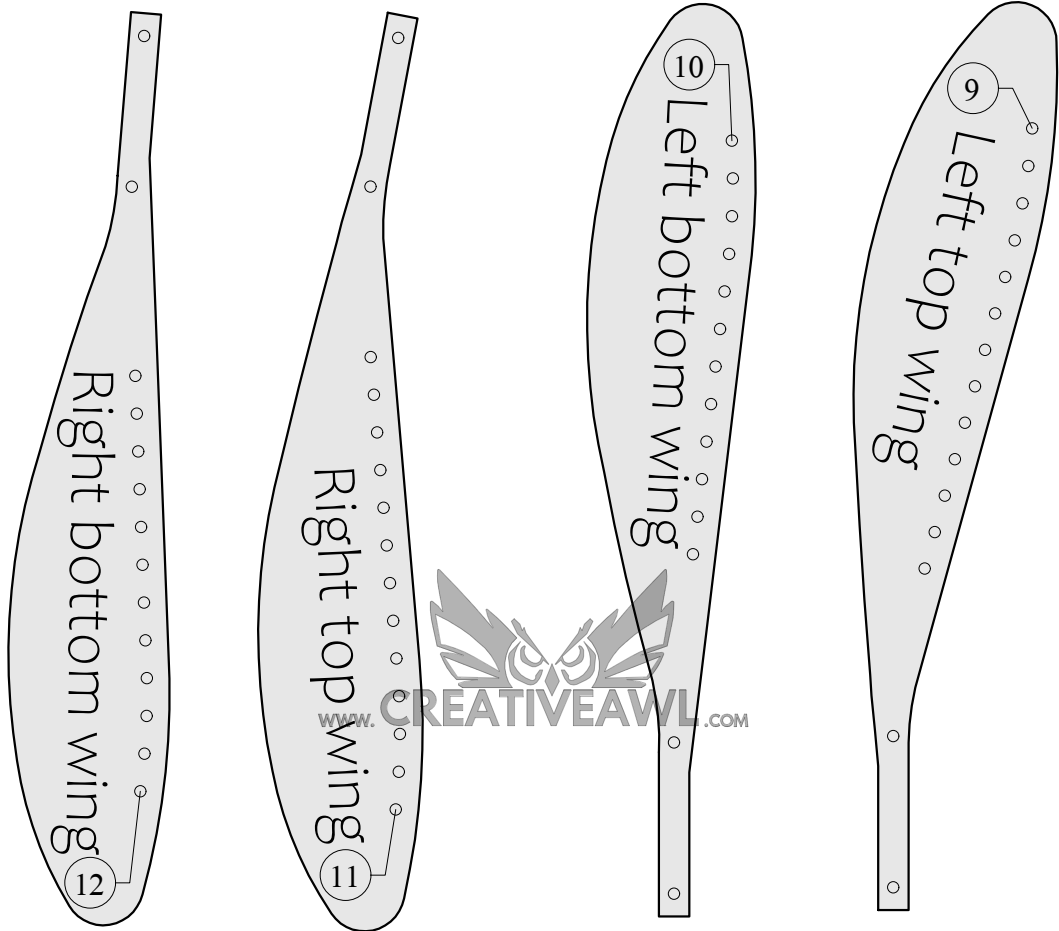
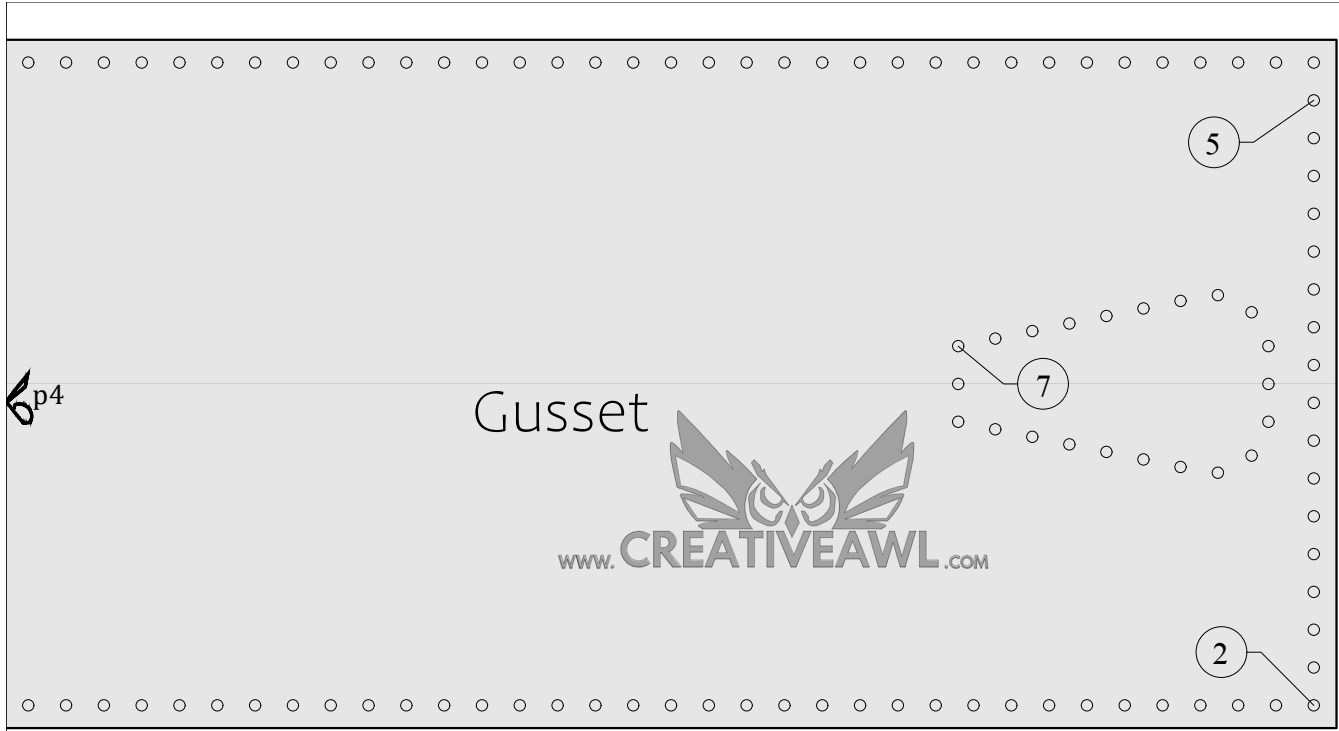

11 in
8,5 in

A4

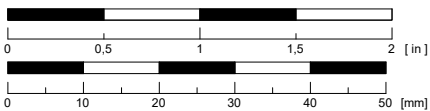

Dragonfly bag

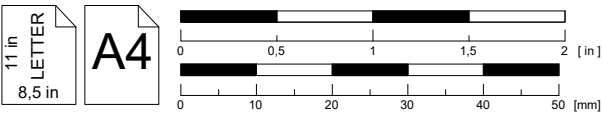
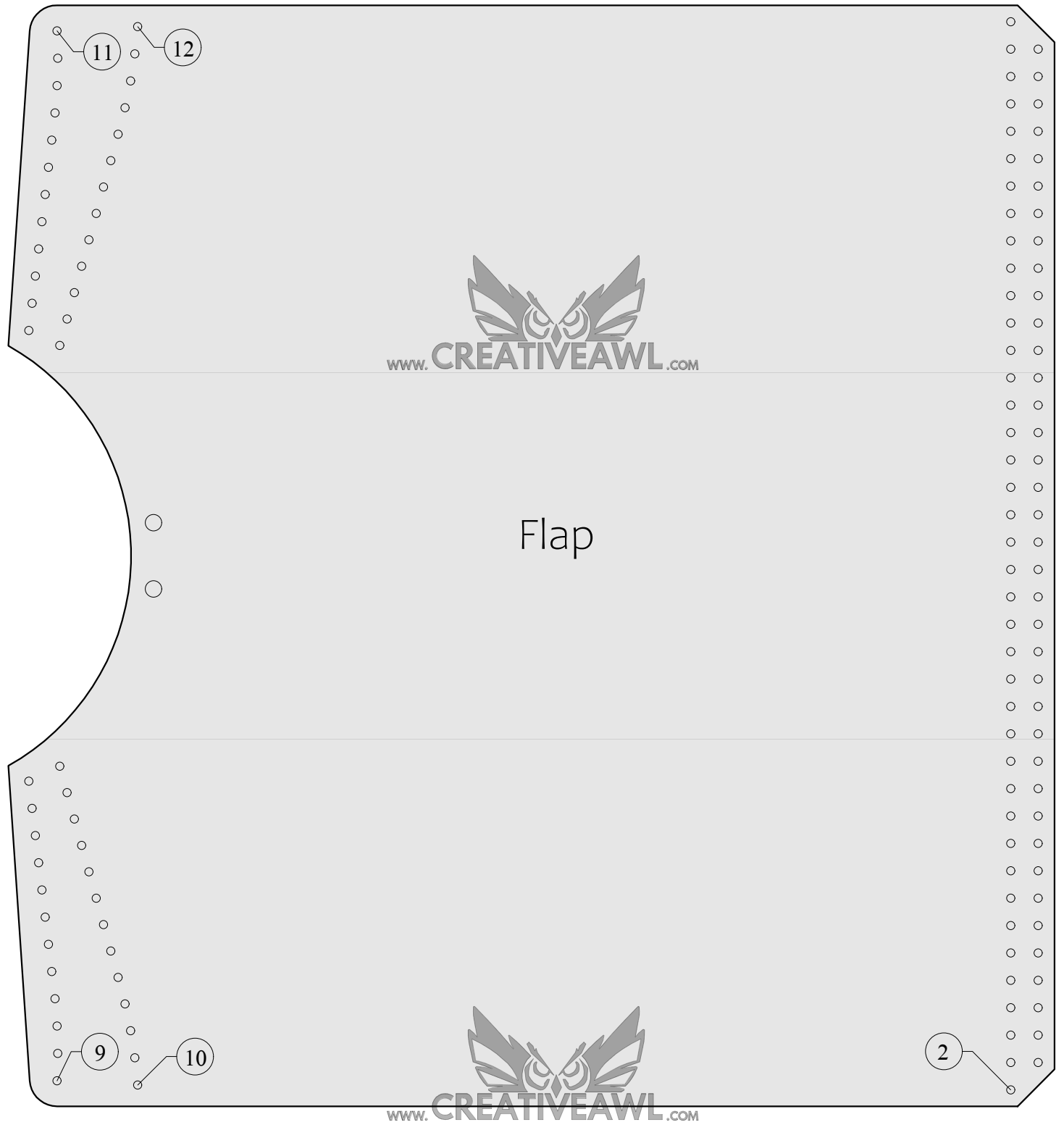

Dragonfly bag