



CREATIVE AWL

**KATIE
BAG**

PREPARED BY:

Patryk Ku,
www.CreativeAwl.com



**PLEASE
READ!**

If it wasn't for your support, this pattern wouldn't have come into being, thanks! If you already post pictures of your bag in the social media, I would be invariably glad if you would mention the author. I also encourage you to share your work on our facebook group.

All rights reserved. No pattern content may be shared or reproduced. If you would like to share pictures of your, please recommend our facebook group or <https://www.creativeawl.com>

You can sell items based on my patterns without any restriction.

Thank you and have fun!
Patryk

LET'S GO:

01

PRINT THE PATTERN

- Open your pattern in Adobe Acrobat Reader. Set up options of your printer on A4 paper with 0 margins (if needed).
- Every page has a measure - check does it fit.
- Every printed page **MUST HAVE** a border around! If doesn't - move paper left/ right and print again and check the settings

02

VIDEO TUTORIAL:

<https://youtu.be/QdkXkKZV1Zw>

Cutting patterns:

https://youtu.be/2TNUI_TIk64

03

GIVE A SMILE TO OTHER PEOPLE!

Give a ready product to you family or freind. Give them a smile :)))

Also Check www.CreativeAwl.com for more patterns

04

JOIN OUR FB GROUP

Go there to share your work. Also get more DIY&ideas. We will support you & answer all questions.

<https://www.facebook.com/groups/CreativeAwlPatterns>

YOU NEED

TOOLS

- sharp knife
- 1-1,5 and 3mm hole puncher
- hammer
- 2 needles
- paper tape
- a home printer

MATERIALS

- about 6.8 sqft (0.63sq meter) of leather
 - 4-6 oz of soft leather
- Waxed thread (preferable 0,8mm)
- 10mm eyelets



SHARE YOUR WORK

<https://www.facebook.com/groups/CreativeAwlPatterns>

If you got ANY problem,- don't be shy to ask directly on
Etsy or facebook

Katie bag:

pages 5 - 24

-The number in the circle shows which holes are to be connected. Example: ①

-Numbers 1, 2, 3 (...) without a circle indicate where the piece lies in the overview drawing.

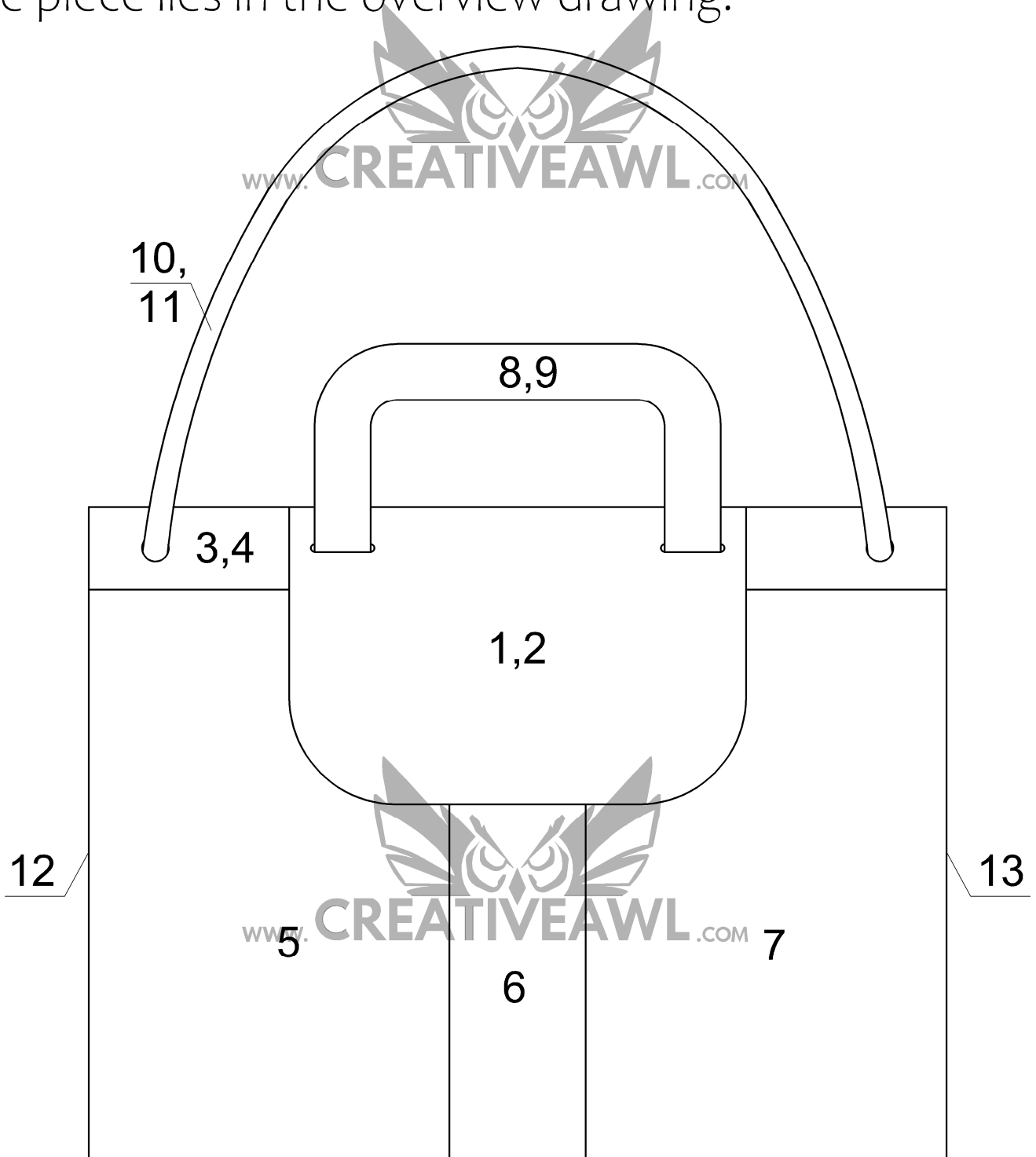

11 in
LETTER
8,5 in

A4

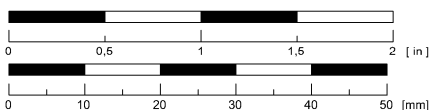

Sketch drawing

Leather needed for a Katie bag:

about 0,63 m2

570 mm (22.8 in)

1100 mm (44 in)

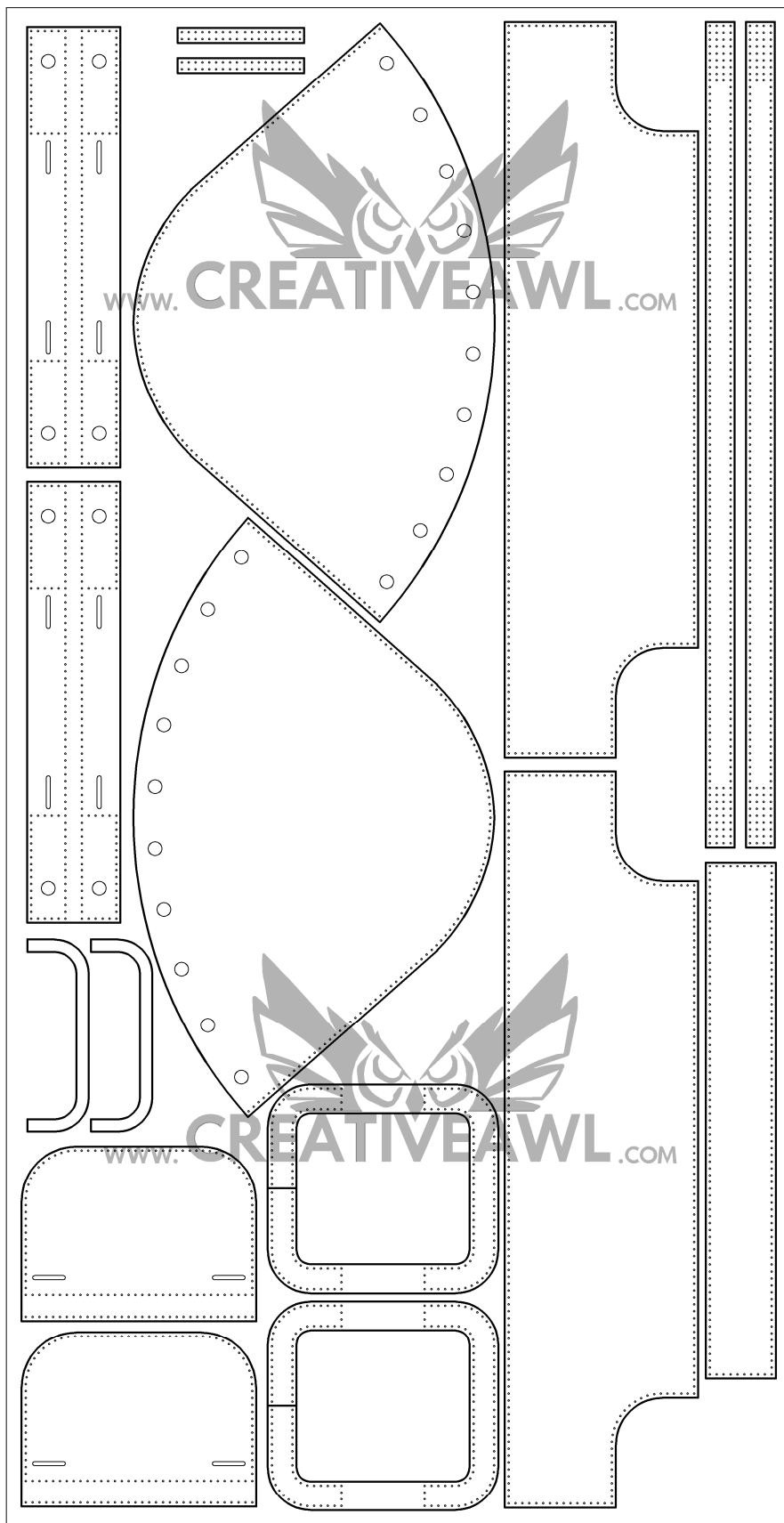

Sketch drawing
Bill of materials

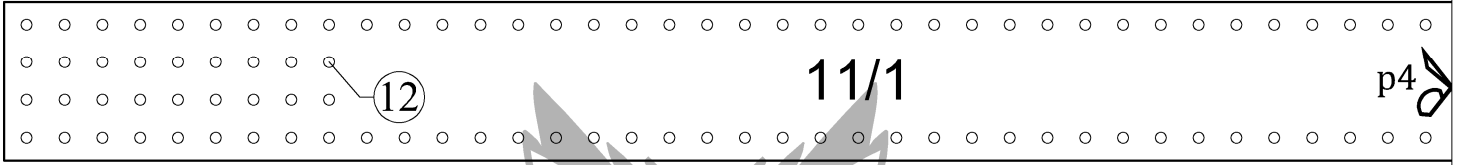
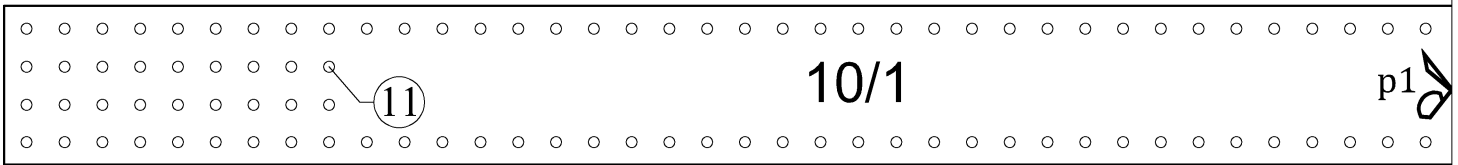

make four of these straps if you want a longer shoulder strap

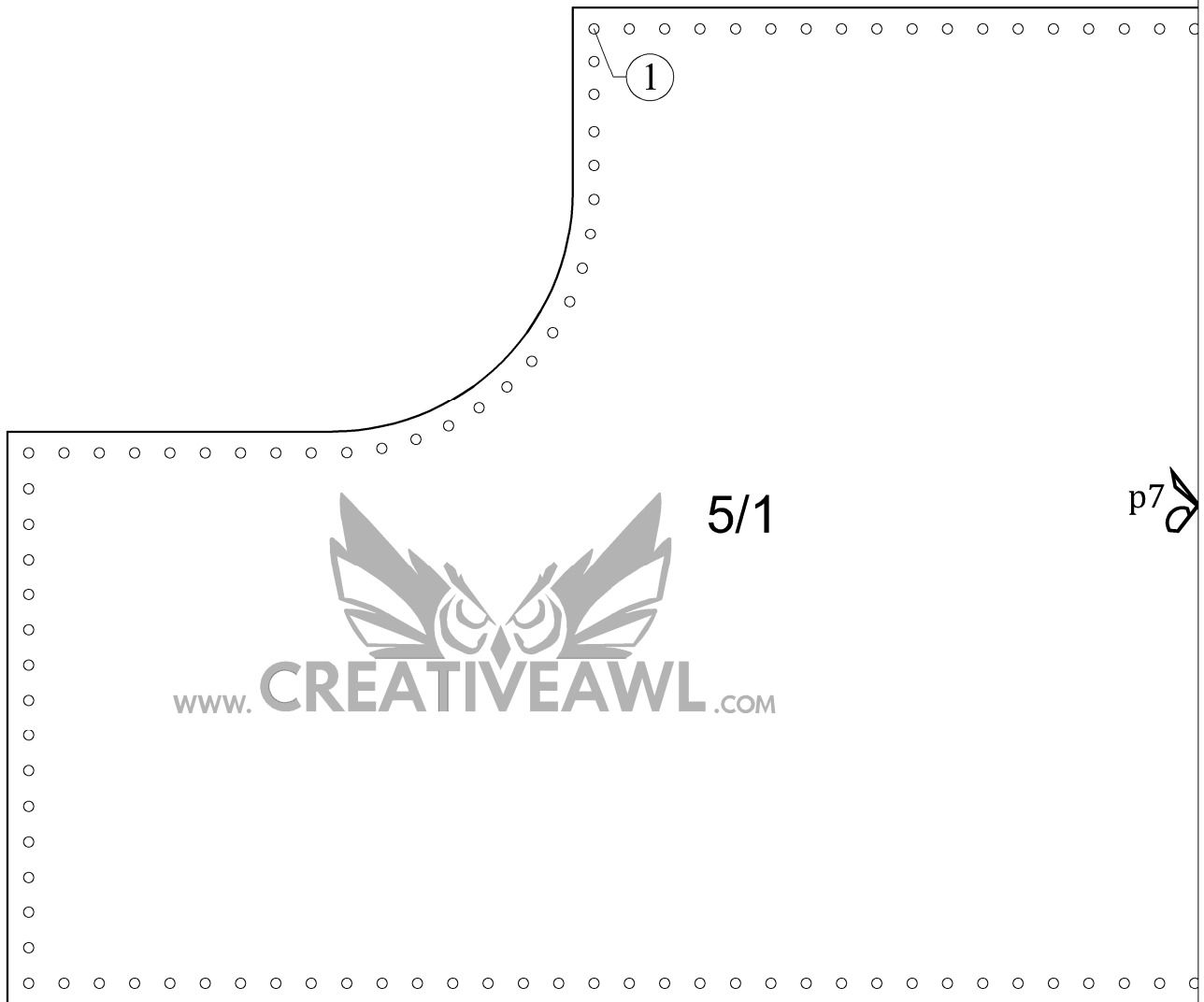

11 in
LETTER
8,5 in

A4

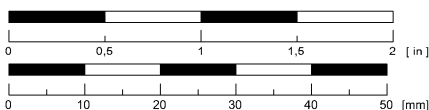

Katie bag: front
and arm handle

p1

10/2

p2

p4

11/2

p5

p21

www.CREATIVEAWL.COM

12/2

p22

make four of these straps if you want a longer shoulder strap

p7

5/2

p8

www.CREATIVEAWL.COM

9

11 in
LETTER
8,5 in

A4

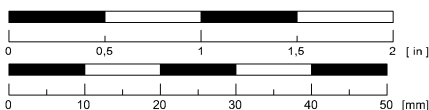

Katie bag: front
and arm handle

8

p2 10/3 p3

p5 11/3 p6

p22 www.CREATIVEAWL.COM 12/3 p23

make four of these straps if you want a longer shoulder strap

p8 5/3

www.CREATIVEAWL.COM

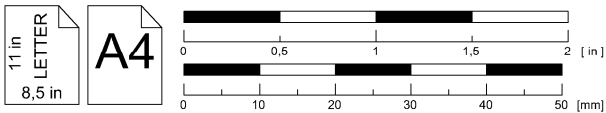
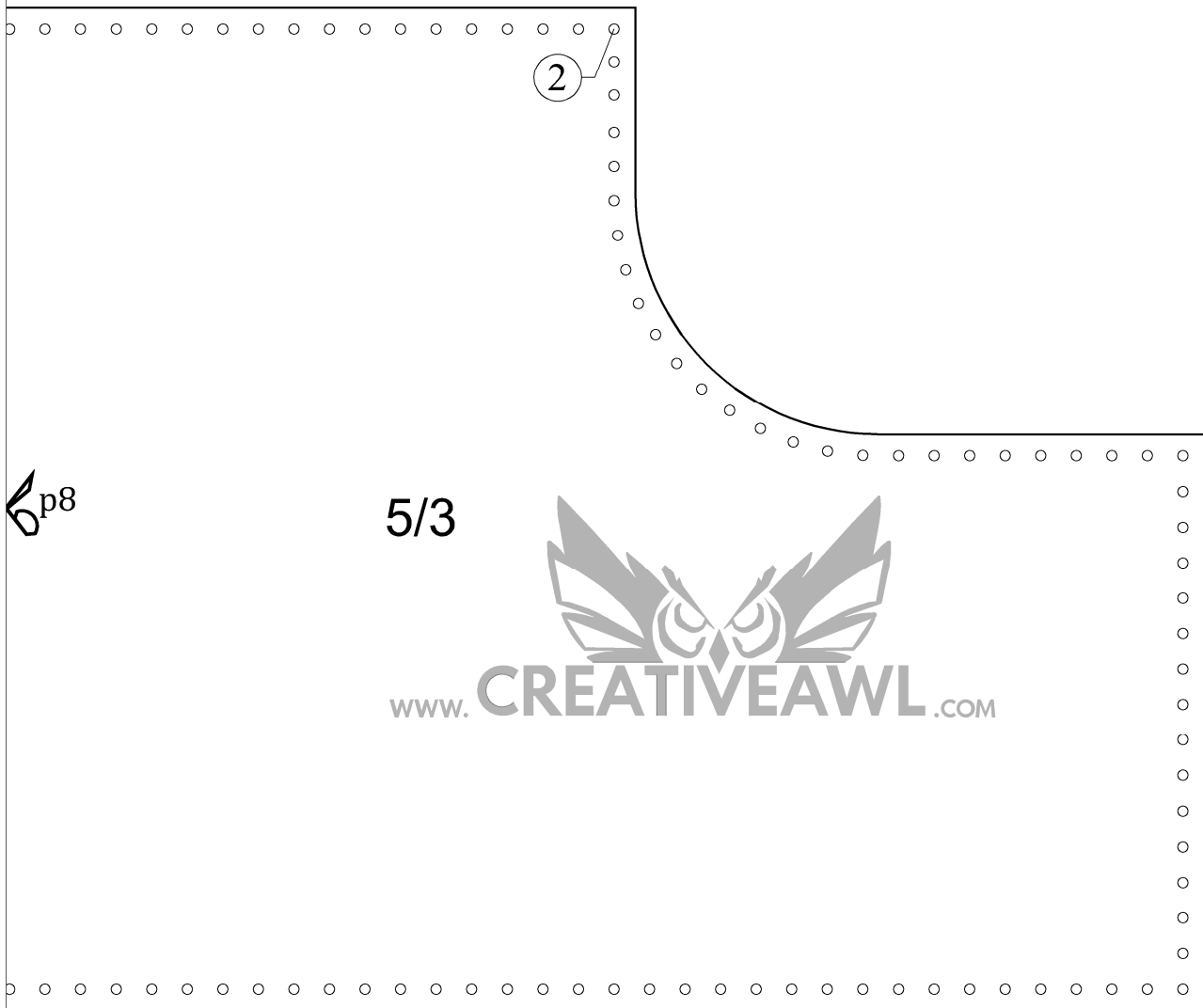

Katie bag: front
and arm handle

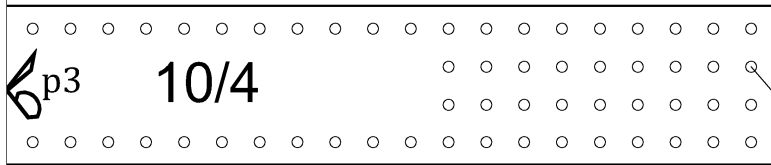

10.1/1

p18

2,5 - 3 mm (7 - 8 oz)

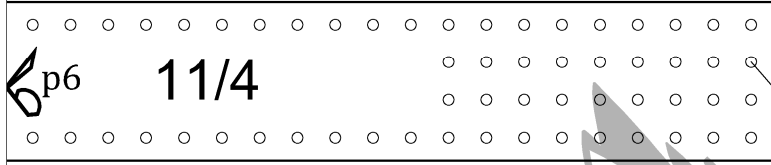

11.1/1

p19

2,5 - 3 mm (7 - 8 oz)

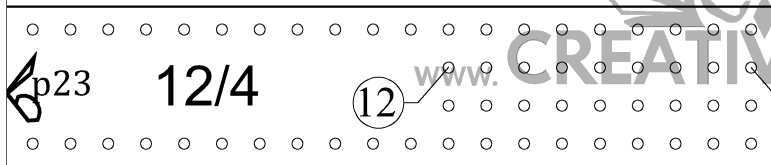

12.1/1

p24

2,5 - 3 mm (7 - 8 oz)



7/1

p9

www.CREATIVEAWL.COM



3

Katie bag: front and arm handle

10

11 in LETTER 8,5 in

A4

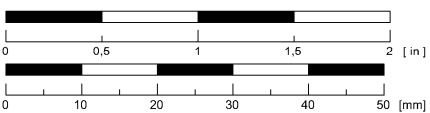

p18

10.1/2

p18

2,5 - 3 mm (7 - 8 oz)

p19

11.1/2

p20

2,5 - 3 mm (7 - 8 oz)



p24

12.1/2

p25

2,5 - 3 mm (7 - 8 oz)



10

p9

7/2

p10

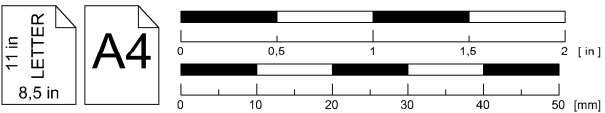

Katie bag: front

p18

10.1/3

2,5 - 3 mm (7 - 8 oz)

p20

11.1/3

2,5 - 3 mm (7 - 8 oz)



p25

12.1/3

2,5 - 3 mm (7 - 8 oz)

p10

7/3

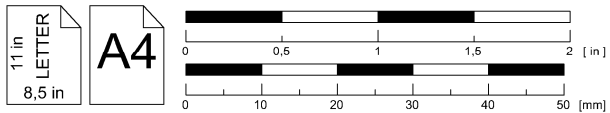
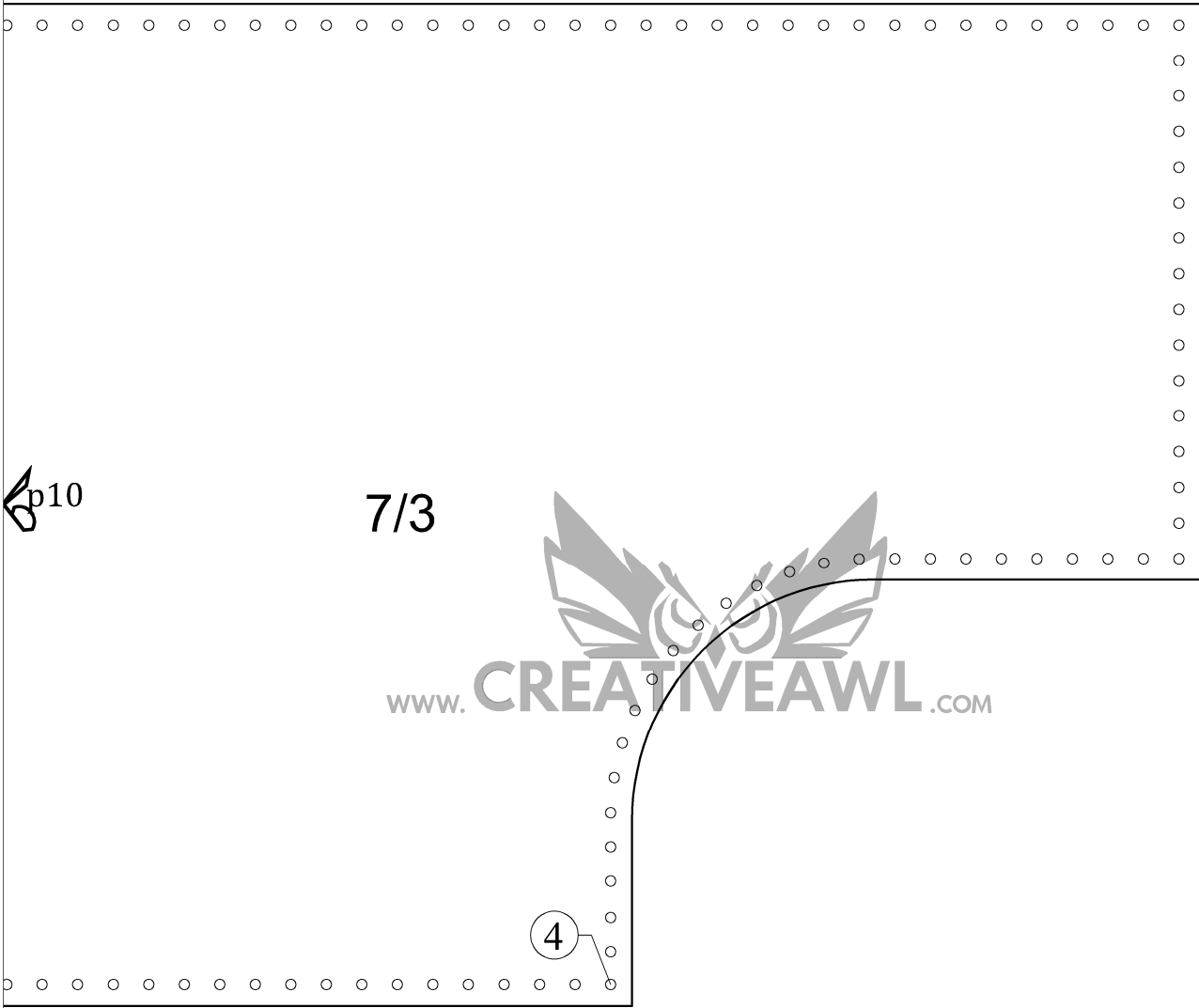
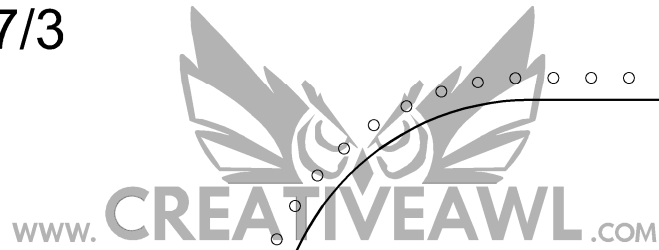

Katie bag: front

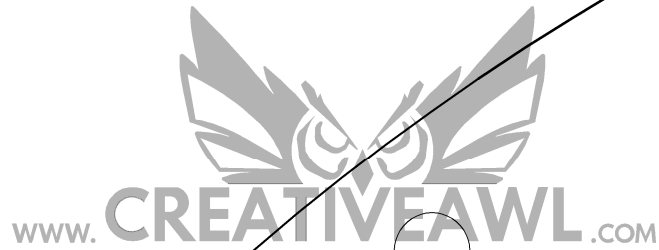

12/1

p11 

11 in
LETTER
8,5 in

A4

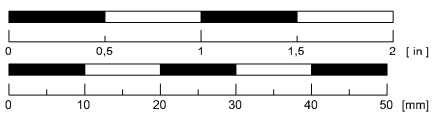

Katie bag: side



p11

p12

12/2



Katie bag: side

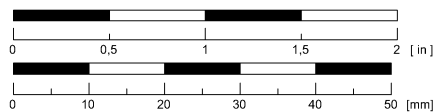
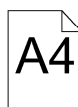

9

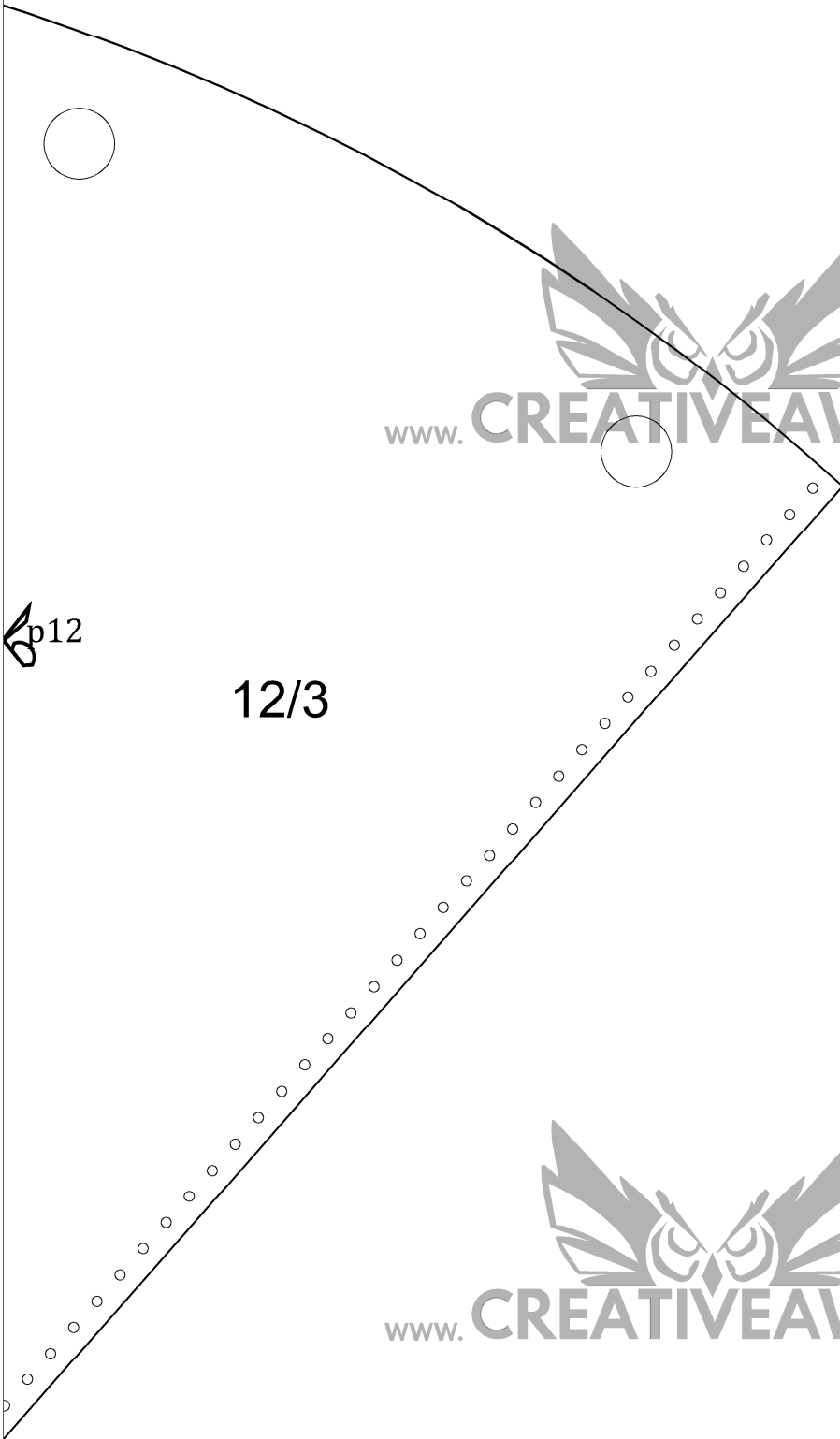

11 in
LETTER
8,5 in

A4

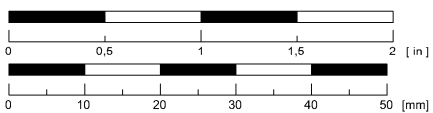

Katie bag: side

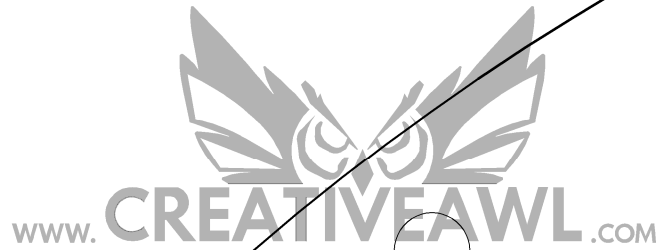

13/1

p13 

11 in
LETTER
8,5 in

A4

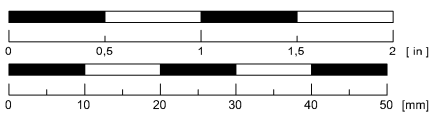

Katie bag: side



p13

p14

13/2



Katie bag: side

11 in
LETTER
8,5 in

A4

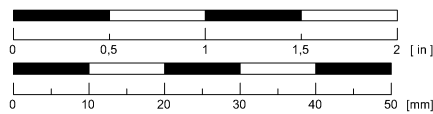

10

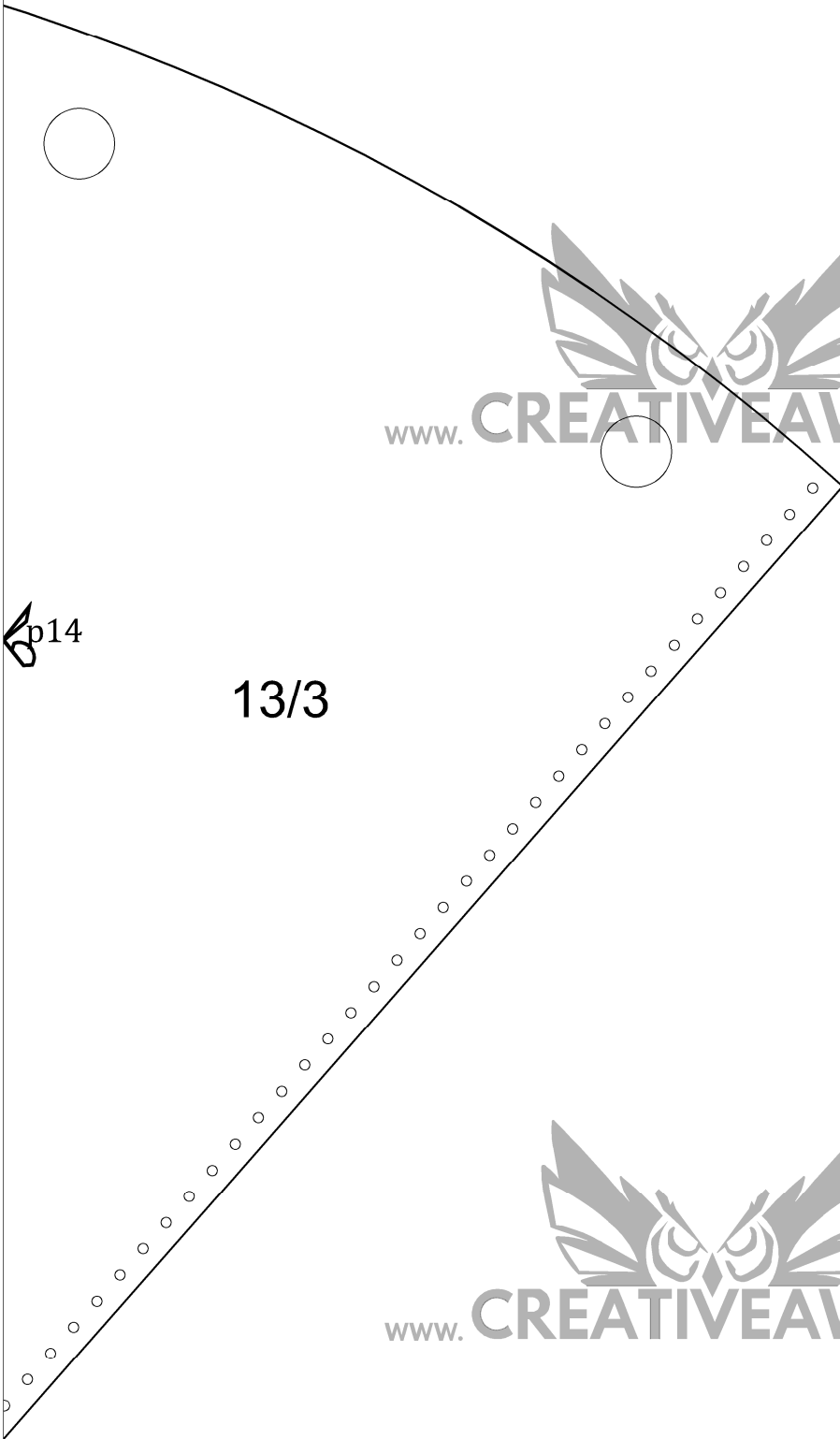

11 in
LETTER
8,5 in

A4

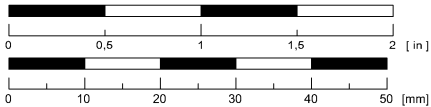

Katie bag: side

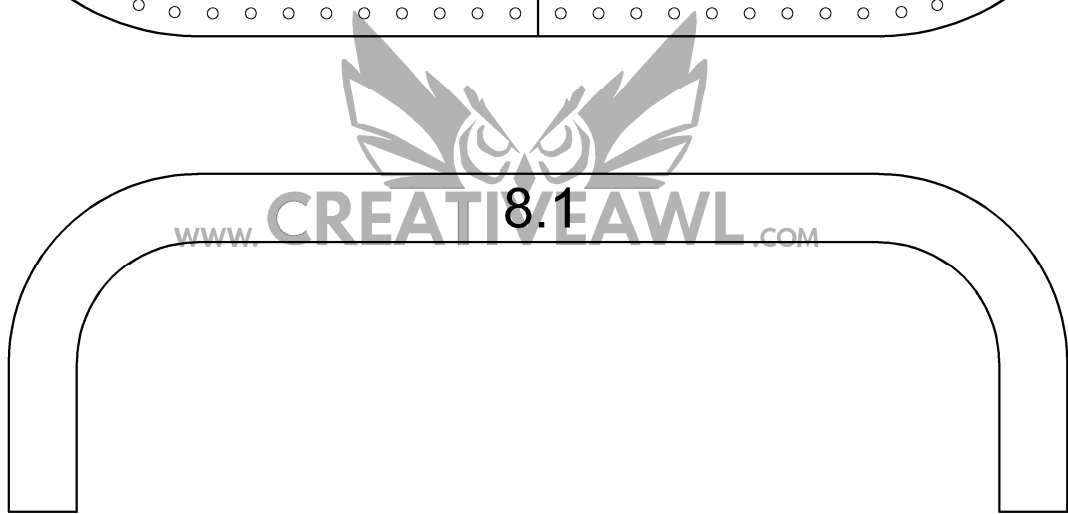
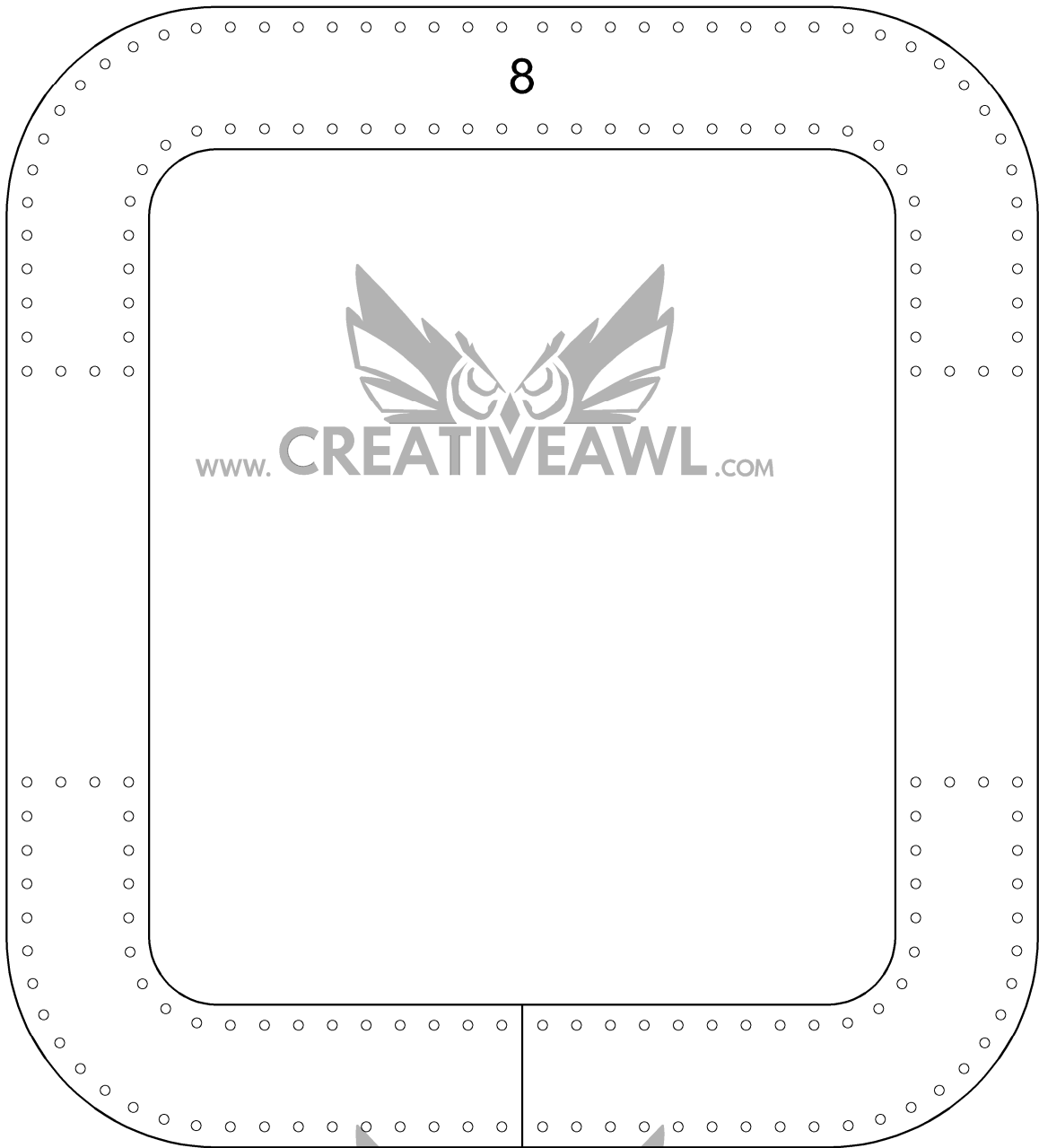

11 in
LETTER
8,5 in

A4

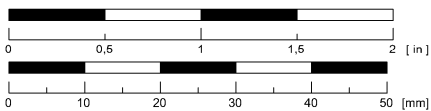

Katie bag: handle

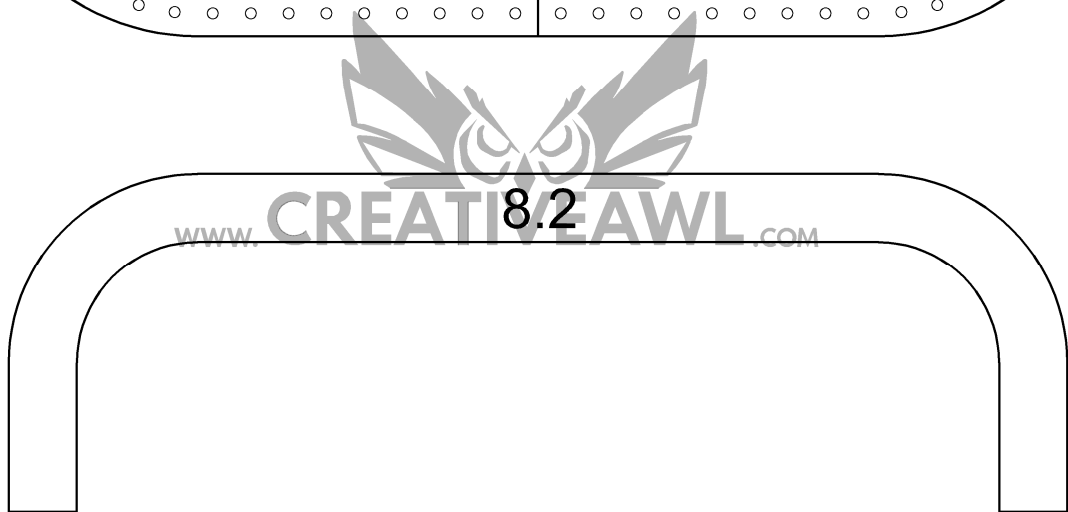
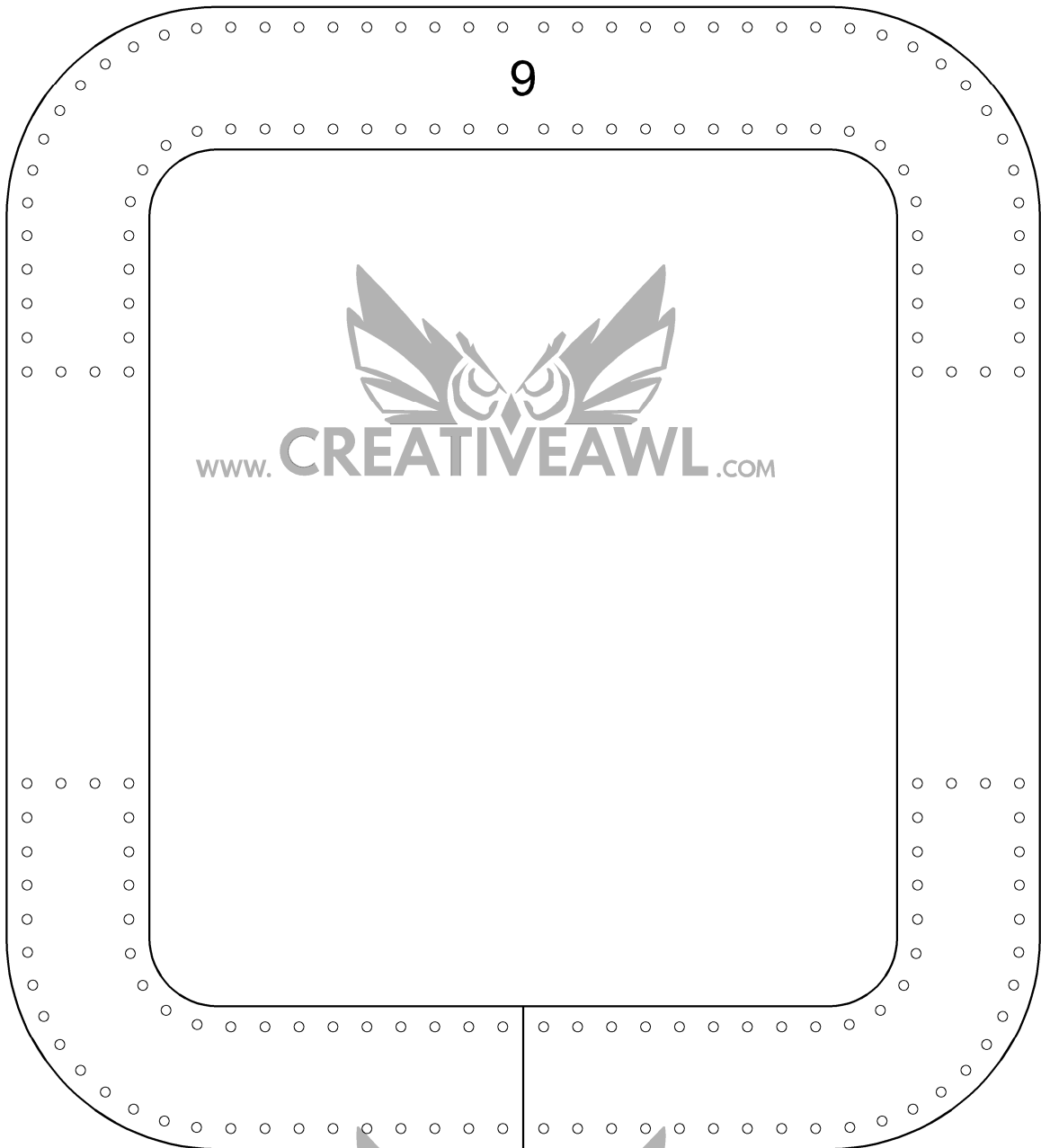

11 in
LETTER
8,5 in

A4

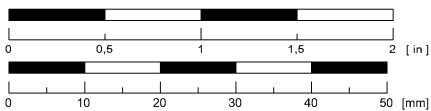

Katie bag: handle

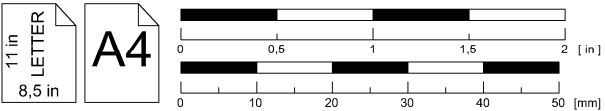
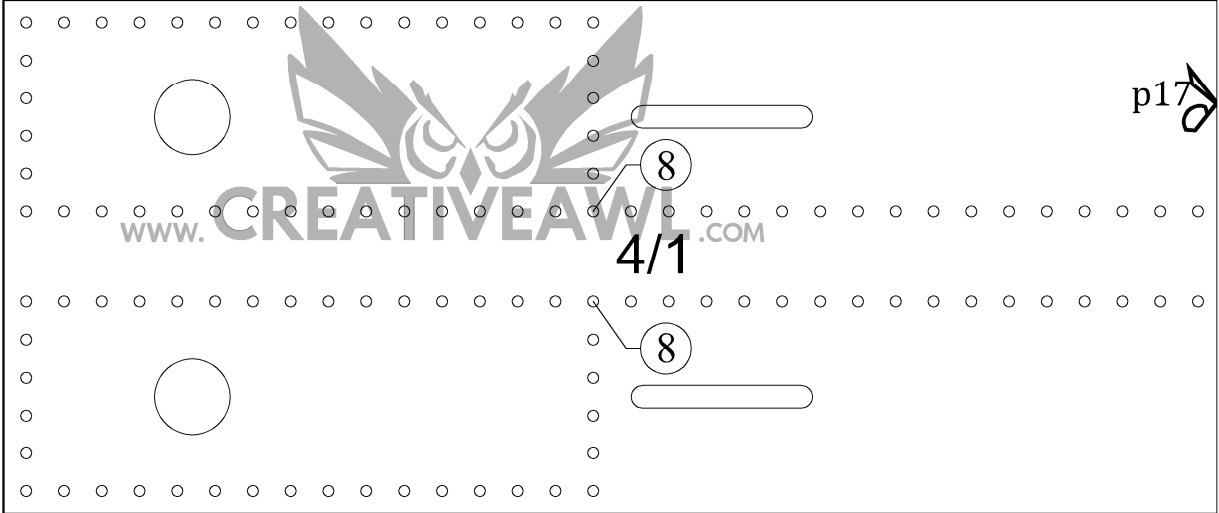
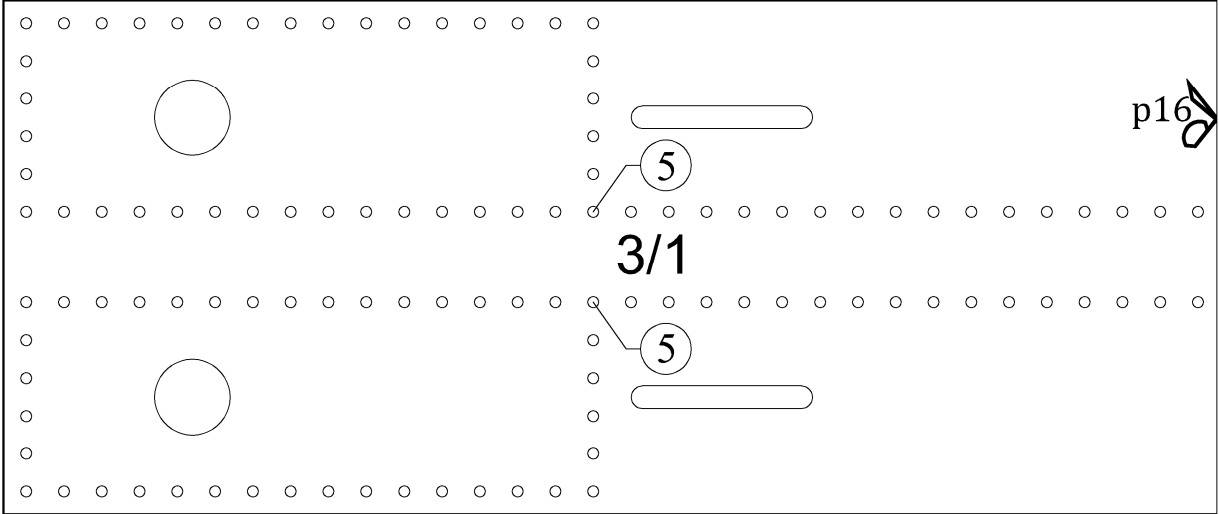
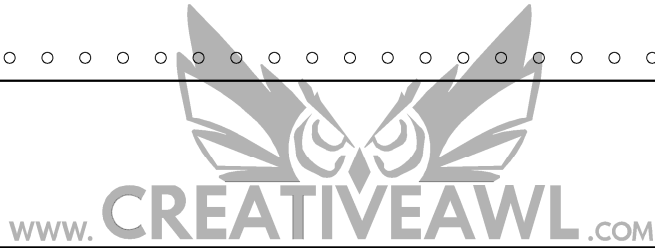
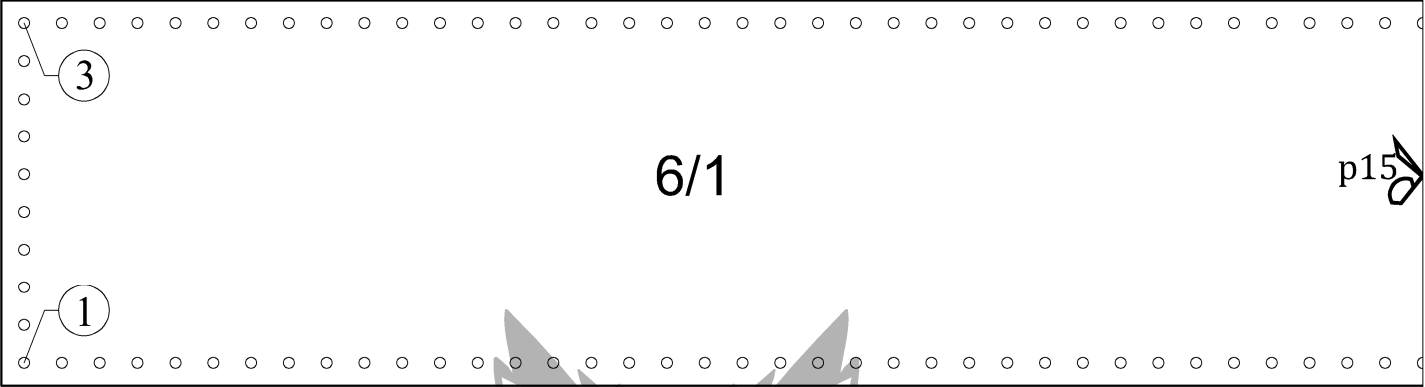

Katie bag: front components

p15

6/2

4

2

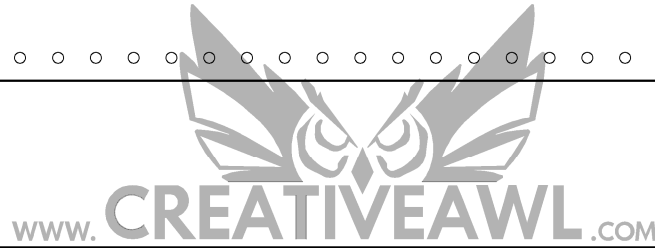

p16

6

3/2

6

p17

7

4/2

7

11 in
LETTER
8,5 in

A4

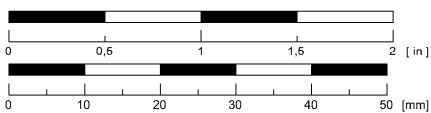

Katie bag: front
components



11 in
LETTER
8,5 in

A4

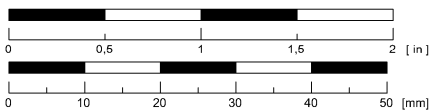

Katie bag: front
components

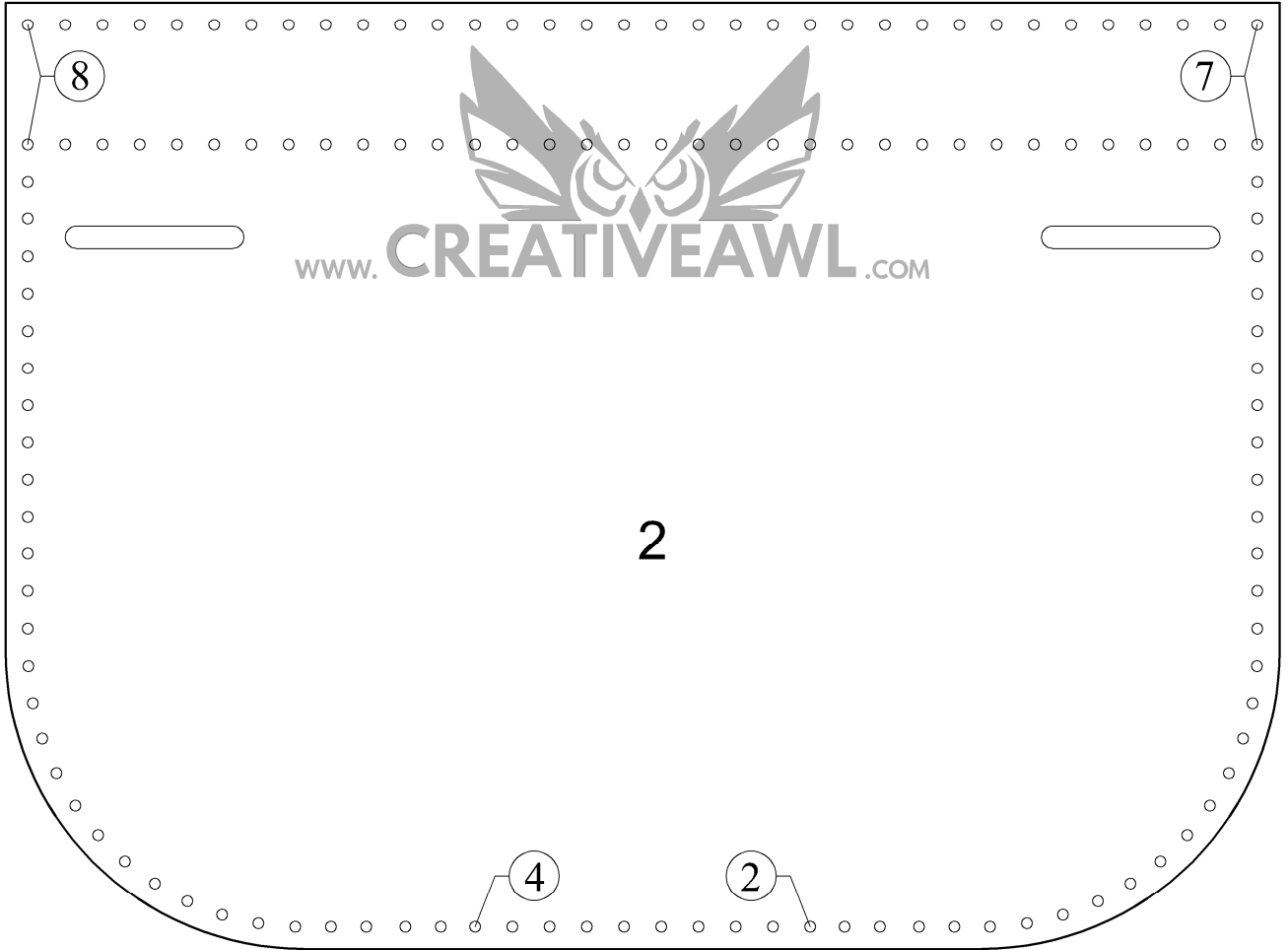

11 in
LETTER
8,5 in

A4

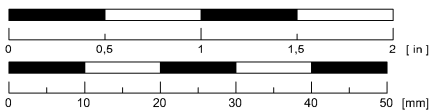

Katie bag: front
components