



CREATIVE AWL  
**ORIGINAL  
PATTERNS**



# Arizona Sachet



 **YouTube**  
VIDEO TUTORIAL

**EASY TO  
PRINT**  
**PDF >>>>**  
**PATTERN**

**LET'S GO!**

• & don't forget check out our free patterns!



**1**



## PRINT THE PATTERN

- Open your pattern in Adobe Acrobat Reader, or any web browser.
- Every page has a measure - check does it fit.
- Every printed page **MUST HAVE** a border around! If doesn't - move paper left/ right and print again

**2**



## FOLLOW VIDEO INSTRUCTIONS

- Video tutorial:  
<https://youtu.be/g9INr3oHJ50>
- Cutting patterns:  
[https://www.youtube.com/watch?v=2TNUI\\_TIk64](https://www.youtube.com/watch?v=2TNUI_TIk64)



**3**



## GIVE A SMILE TO OTHER PEOPLE !

- Give a ready product to you family or friend.  
Give them a smile :)))
- Also Check [www.CreativeAwl.com](http://www.CreativeAwl.com) for more patterns

**4**



## JOIN OUR FB GROUP

- Go there to share your work. Also get more DIY&ideas. We will support you & answer all questions.  
<https://www.facebook.com/groups/CreativeAwlPatterns/>



**YOU NEED**

## **MATERIALS**

- **2.8SQFT (0.26 SQM)**  
**(PREFERABLE A 5OZ (2MM))**
- **WAXED THREAD (PREFERABLE 0,8MM)**
  - **ZIPPER**
  - **2 X D-RING 20MM**
- **CLOSURE / BUTTON**

## **TOOLS**

- **SHARP KNIFE**
- **1.2 - 1.5 MM HOLE PUNCHER / PRICKING IRONS OR AWL**
- **HAMMER**
- **2 NEEDLES**
- **PAPER TAPE**
- **A HOME PRINTER**

**SHARE YOUR WORK**

[https://www.facebook.com/groups/](https://www.facebook.com/groups/CreativeAwlPatterns)

CreativeAwlPatterns

# Arizona sachet:

pages 4 - 12

-The number in the circle shows which holes are to be connected. Example: ①

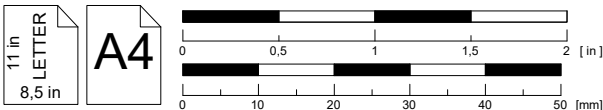
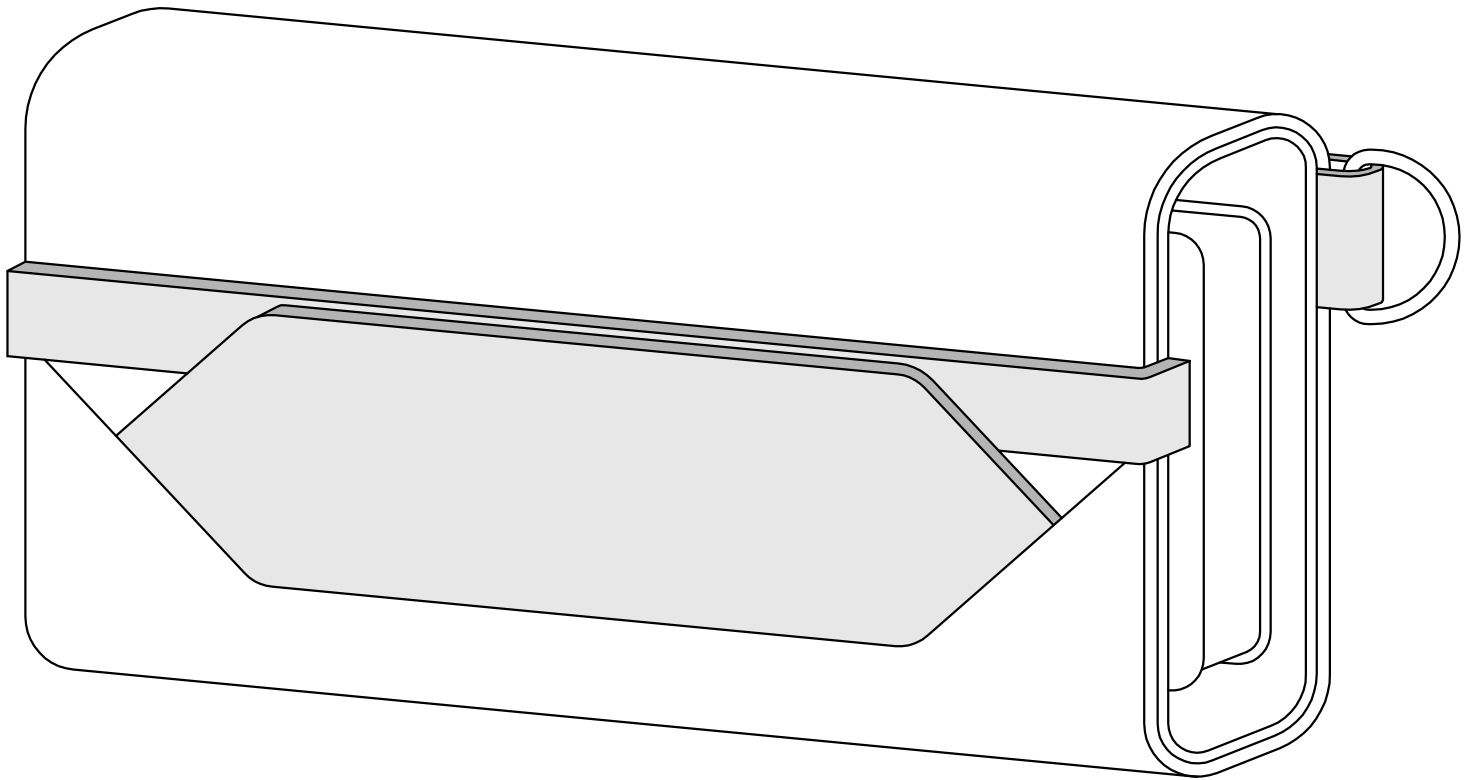

Sketch drawing

Leather needed for a Arizona satchet:

about 0,26 m2

480 mm (18.9 in)

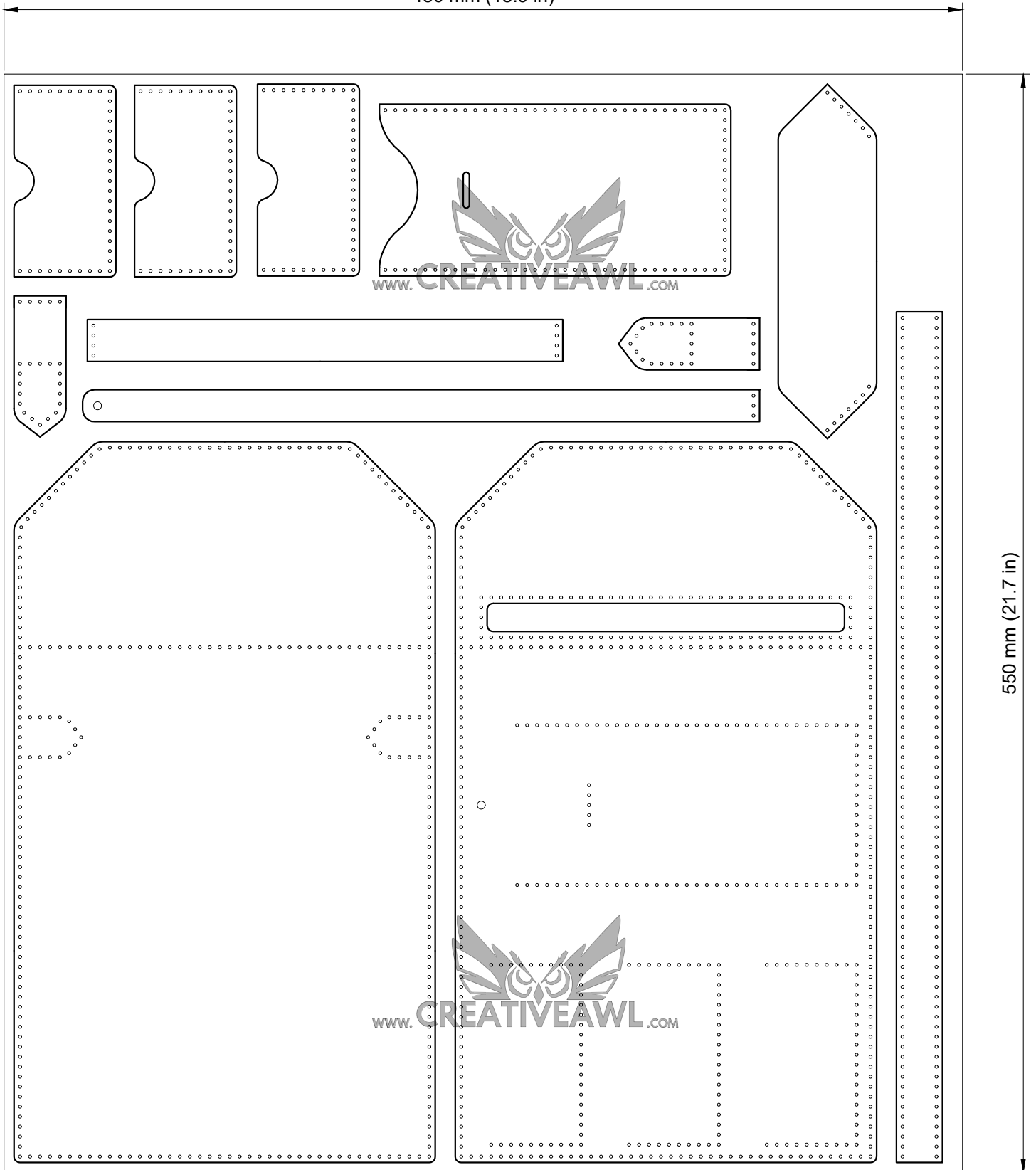

Sketch drawing  
Bill of materials



11 in  
8,5 in

A4

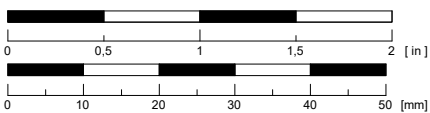

Arizona sachet

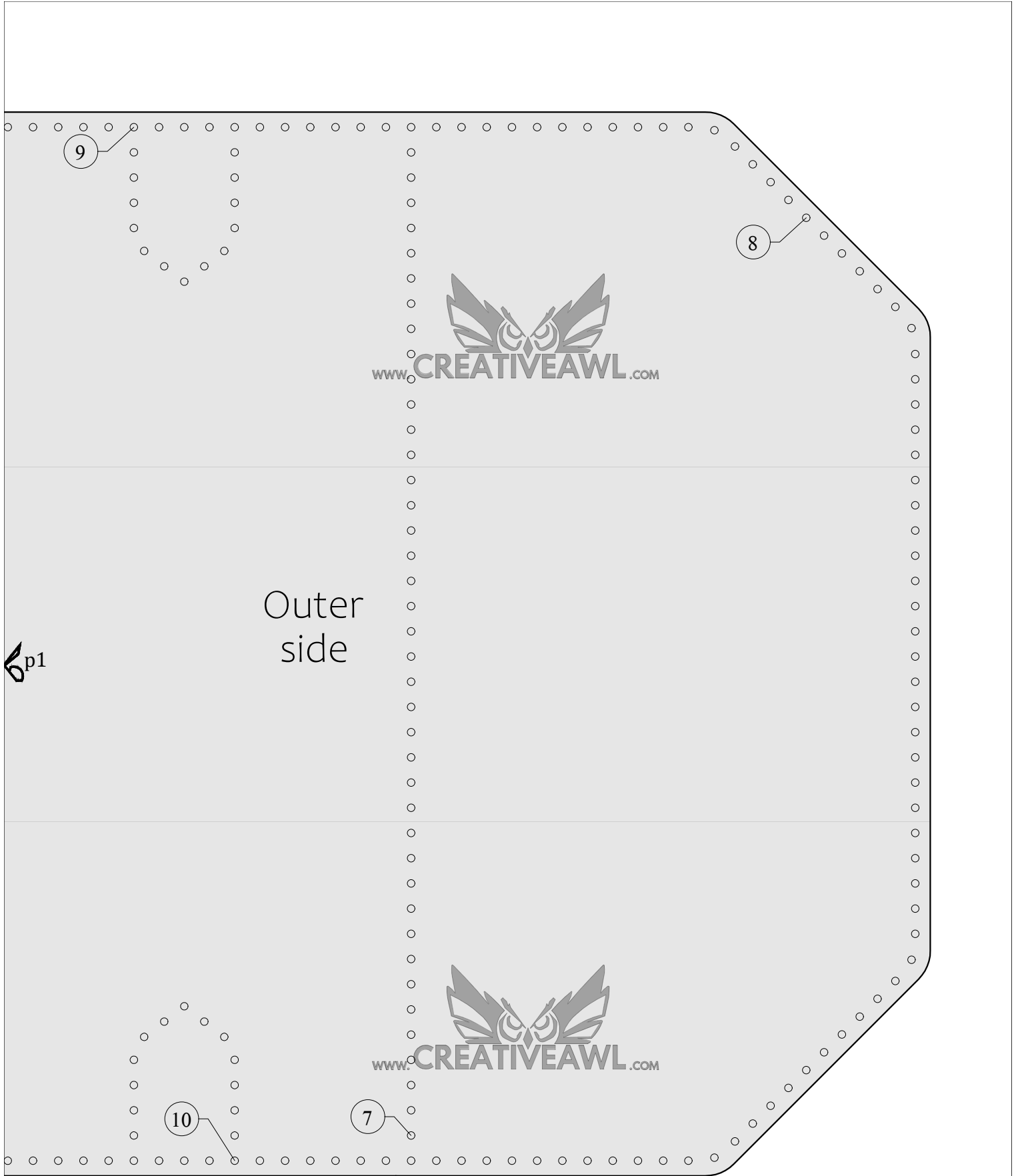

11 in  
8,5 in

**A4**

0 0.5 1 1.5 2 [in]

0 10 20 30 40 50 [mm]

Arizona sachet

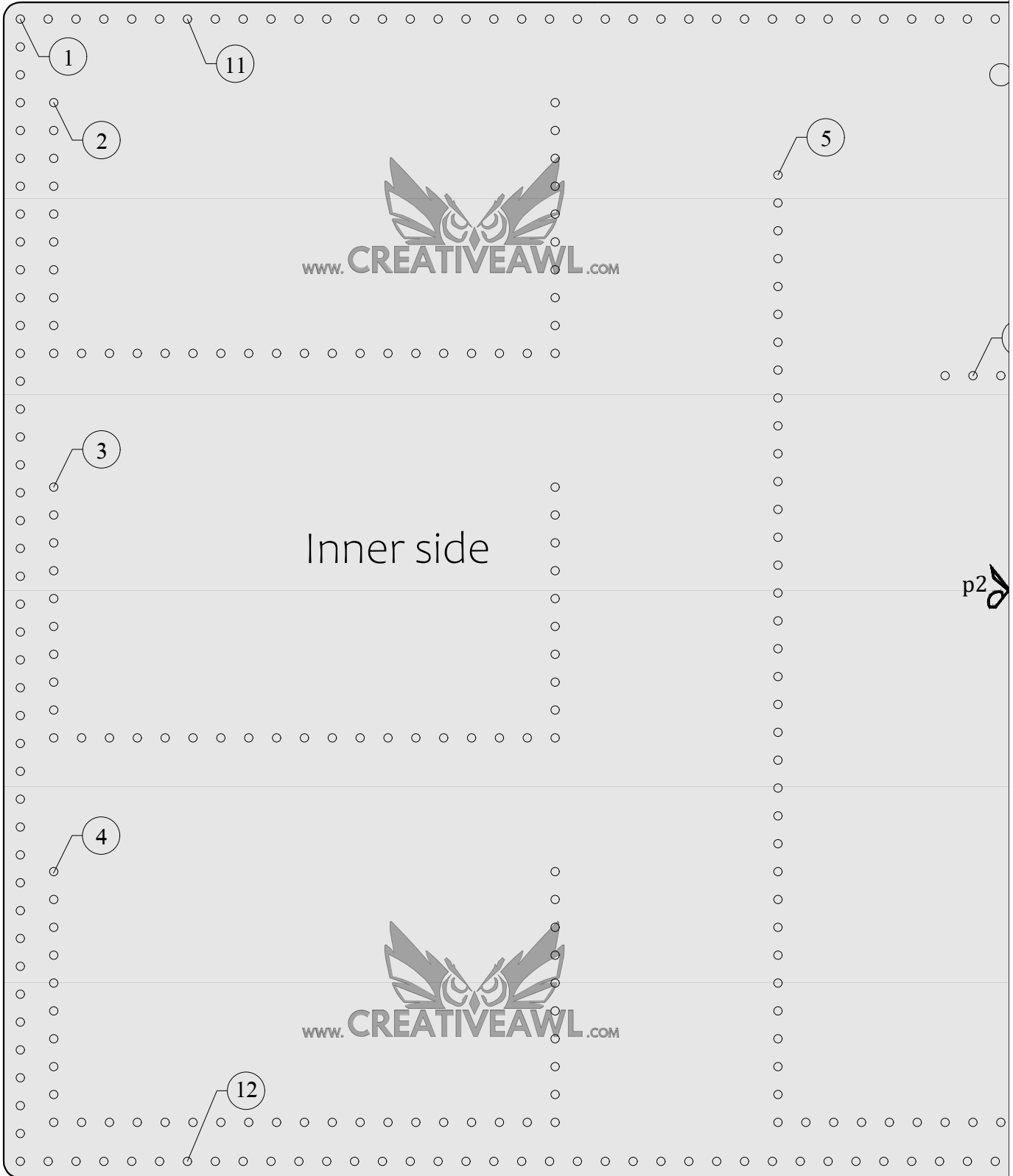

11 in  
8,5 in

A4



Arizona sachet



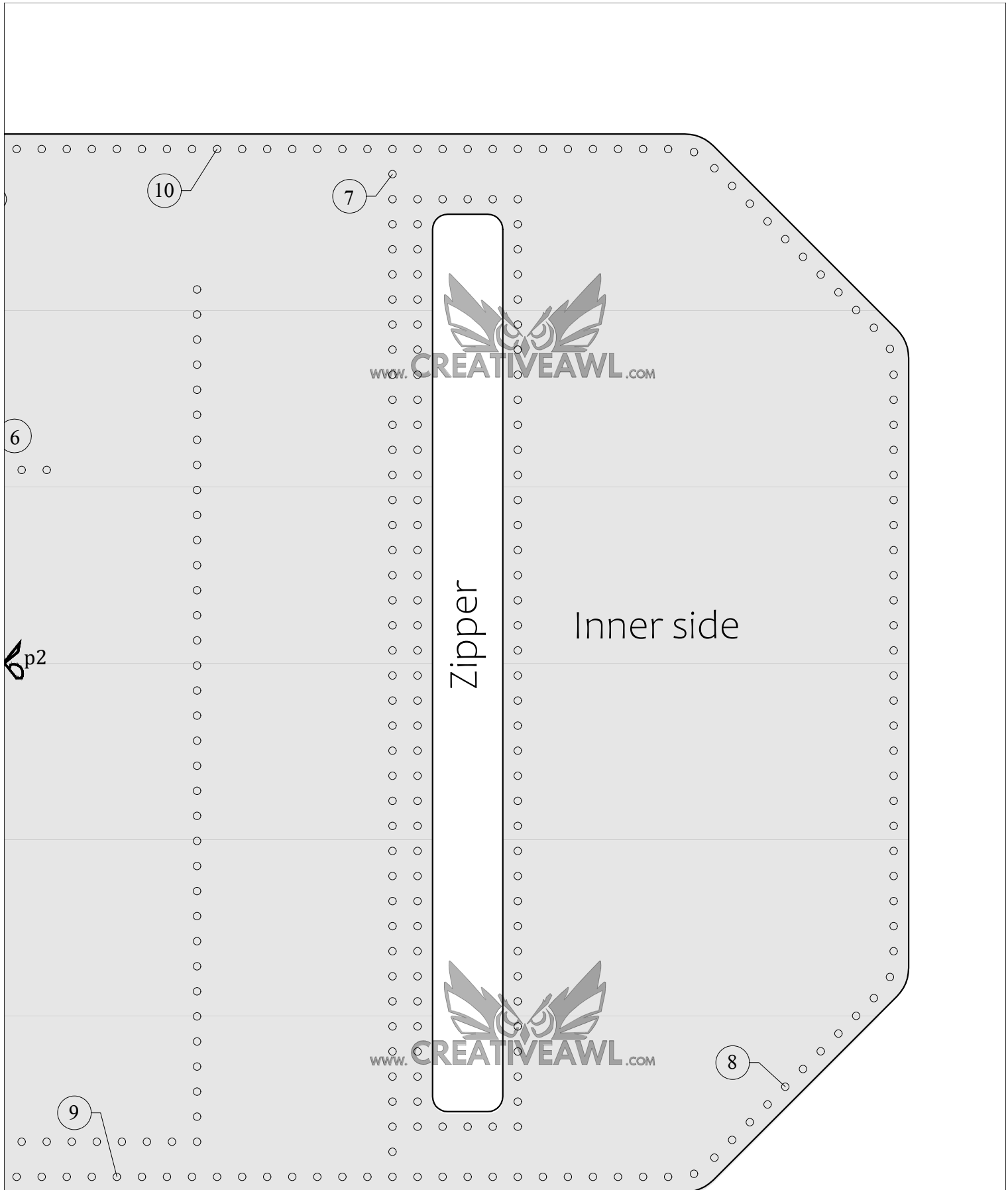

11 in  
LETTER  
8,5 in

A4

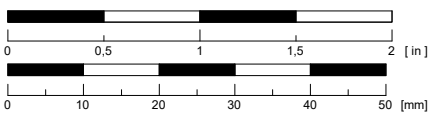

Arizona sachet

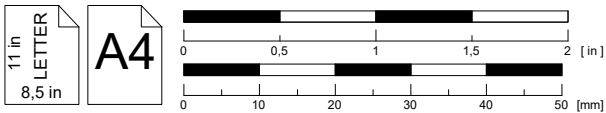
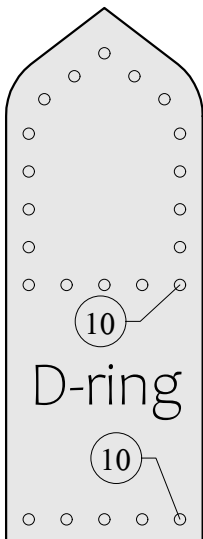
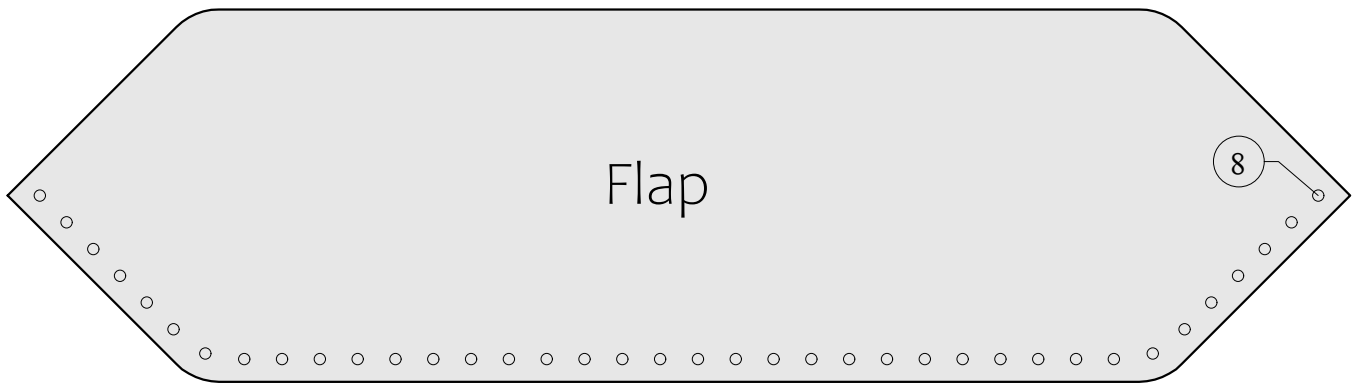
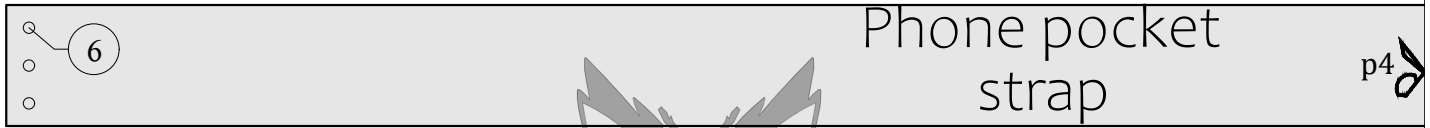
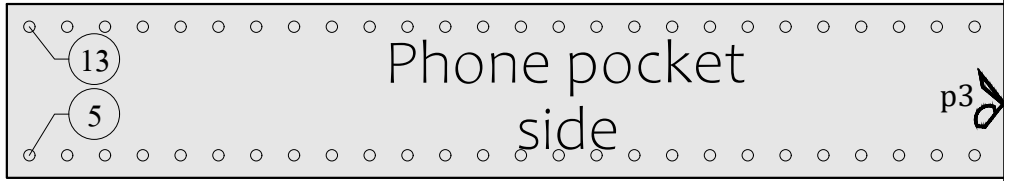

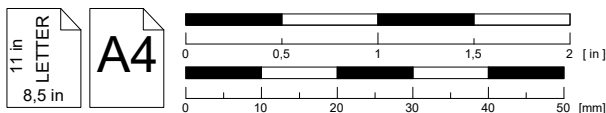
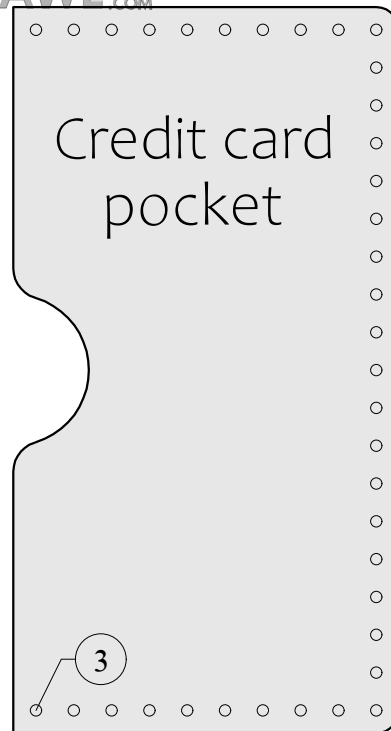
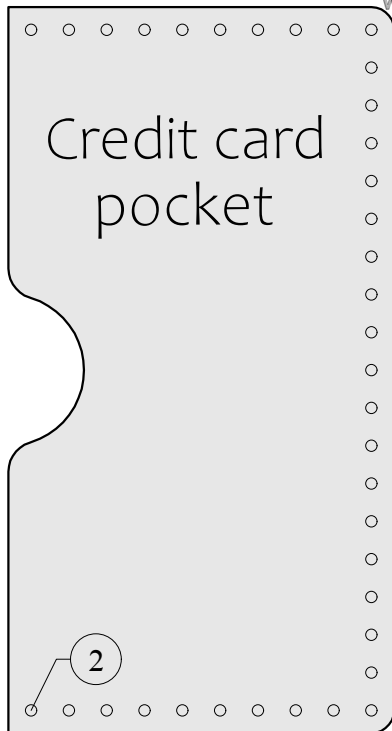

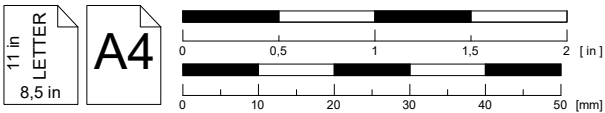
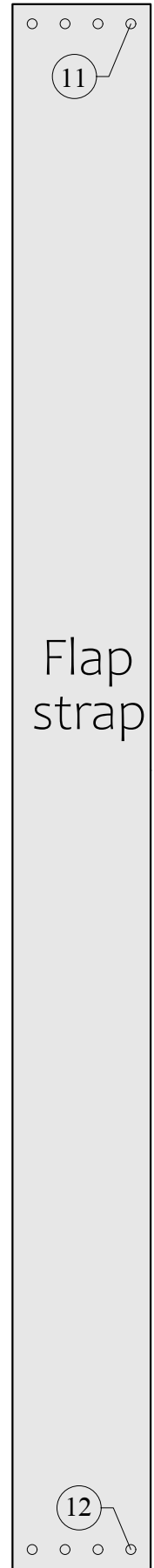
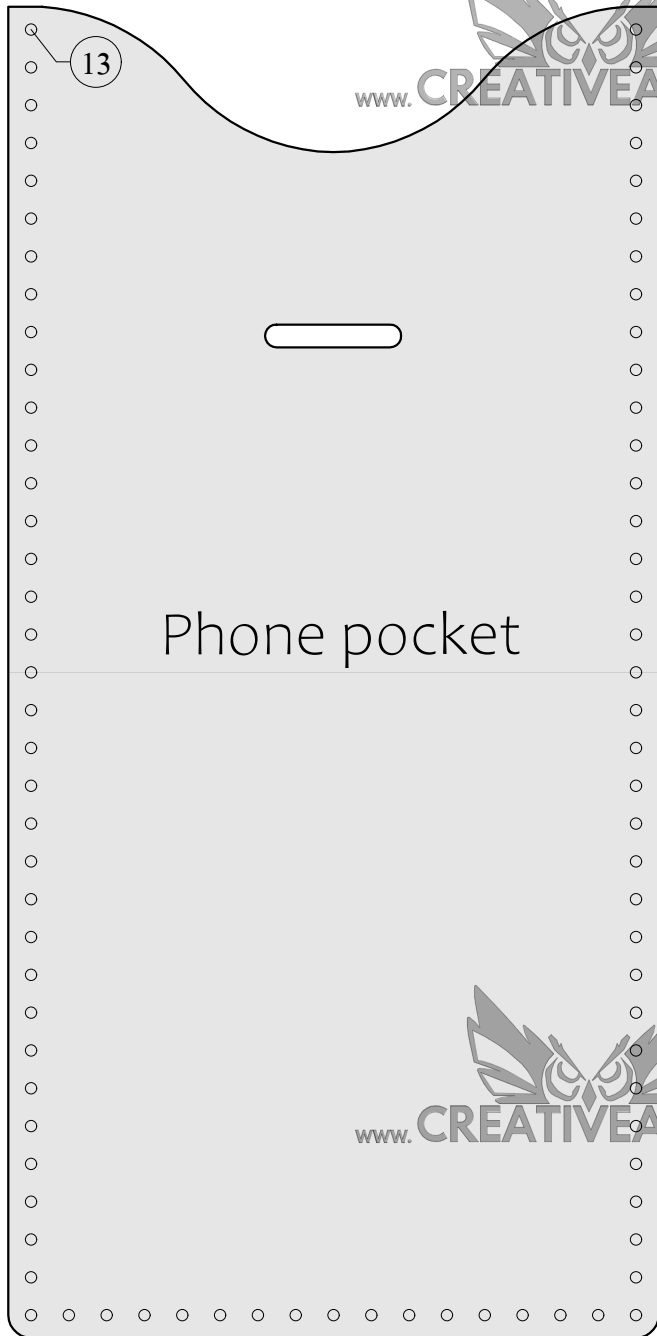

Arizona sachet