

CREATIVE AWL

leather patterns

X-DOPP KITBAG

PREPARED BY:

Patryk Ku,
www.CreativeAwl.com



**PLEASE
READ!**

If it wasn't for your support, this pattern wouldn't have come into being, thanks! If you already post pictures of your bag in the social media, I would be invariably glad if you would mention the author. I also encourage you to share your work on our facebook group.

All rights reserved. No content may be shared or reproduced. If you would like to share it, please recommend our facebook group or <https://www.creativeawl.com>

Thank you and have fun!

Patryk

LET'S GO:

PRINT THE PATTERN

01

- Open your pattern in Adobe Acrobat Reader. Set up options of your printer on A4 paper with 0 margins (if needed).
- Every page has a measure - check does it fit.
- Every printed page **MUST HAVE** a border around! If doesn't - move paper left/ right and print again and check the settings

02

VIDEO TUTORIAL:

<https://youtu.be/EfqK794OmFI>

(The duffle Bags are done the same way like a dopp kit)

Cutting patterns:

https://youtu.be/2TNUl_Tlk64

03

GIVE A SMILE TO OTHER PEOPLE!

Give a ready product to you family or freind. Give them a smile :)))

Also Check www.CreativeAwl.com for more patterns

04

JOIN OUR FB GROUP

Go there to share your work. Also get more DIY&ideas. We will support you & answer all questions.

<https://www.facebook.com/groups/CreativeAwlPatterns>

YOU NEED

TOOLS

- sharp knife
- 1-1,5 and 3, 4, 8, 10mm hole punchers
- hammer
- 2 needles
- paper tape
- a home printer

MATERIALS

- about 0,2 square meter of leather (4-6oz)
- 0,8mm waxed thread
- 2 zippers
- 1 button / fastener
- 4 rivets



SHARE YOUR WORK

<https://www.facebook.com/groups/CreativeAwlPatterns>

If you got ANY problem,- don't be shy to ask directly on
Etsy or facebook

X - dopp kit:

pages: 5 - 13

-The number in the circle shows which holes are to be connected. Example: ①

-Numbers 1, 2, 3 (...) without a circle indicate where the piece lies in the overview drawing.

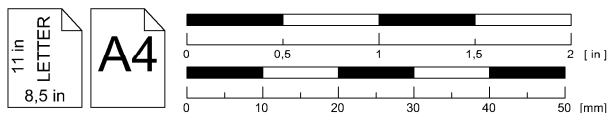
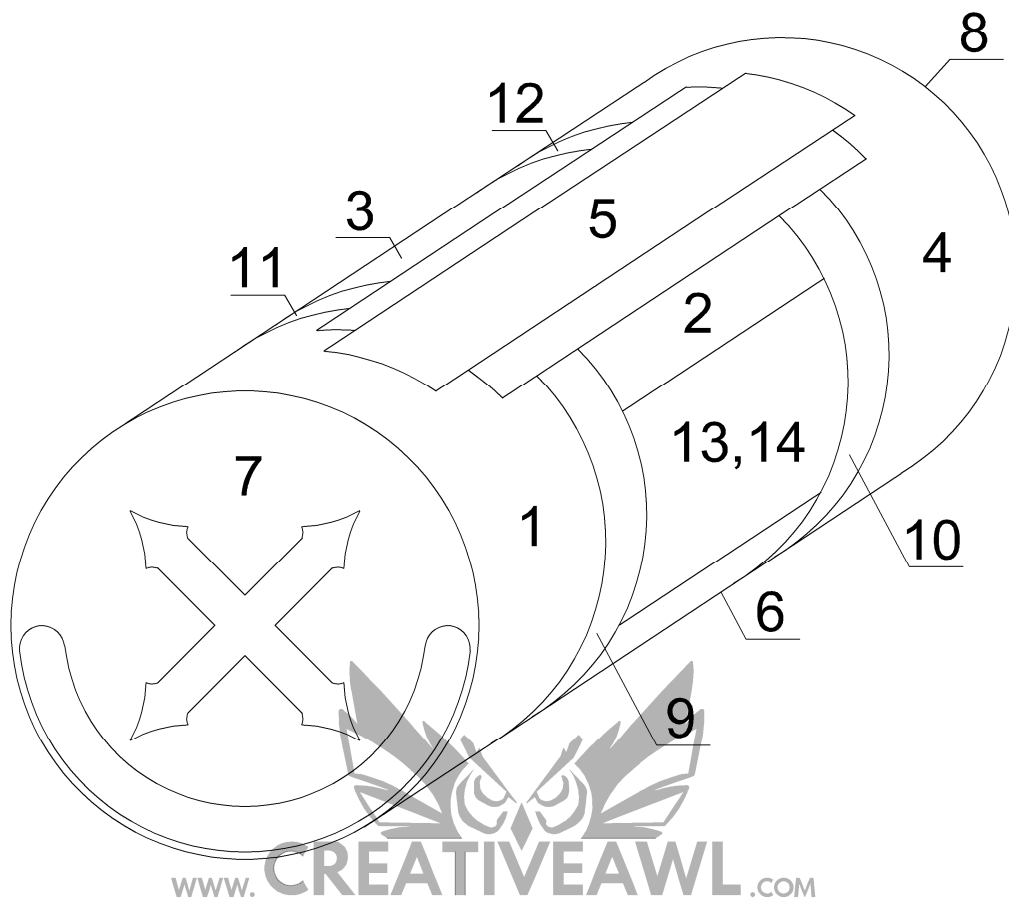

Sketch drawing

Leather needed for a X - dopp kit:
330 mm (13,2 in)

about 0,20 m2

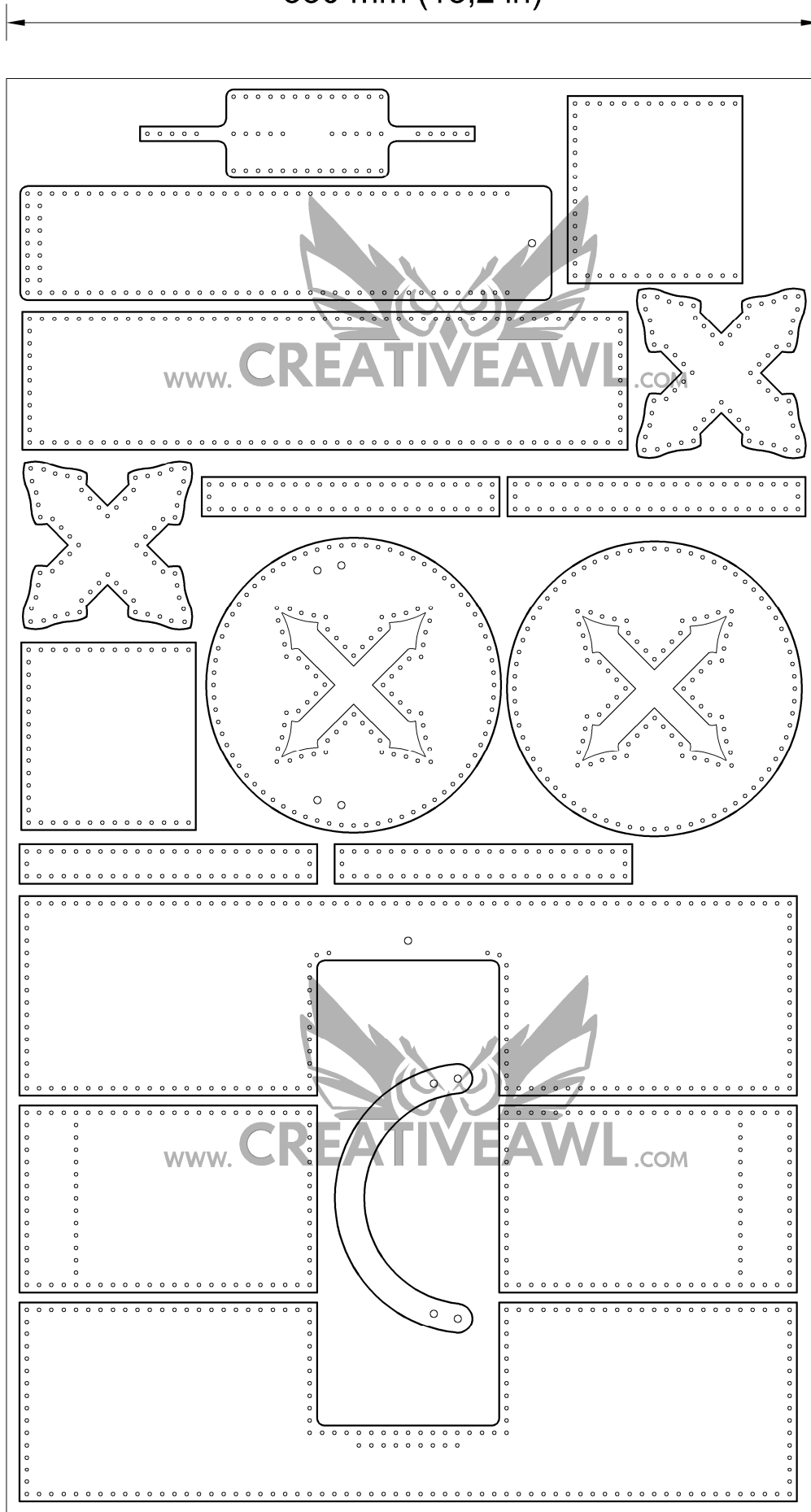

580 mm (23,2 in)

Sketch drawing
Bill of materials

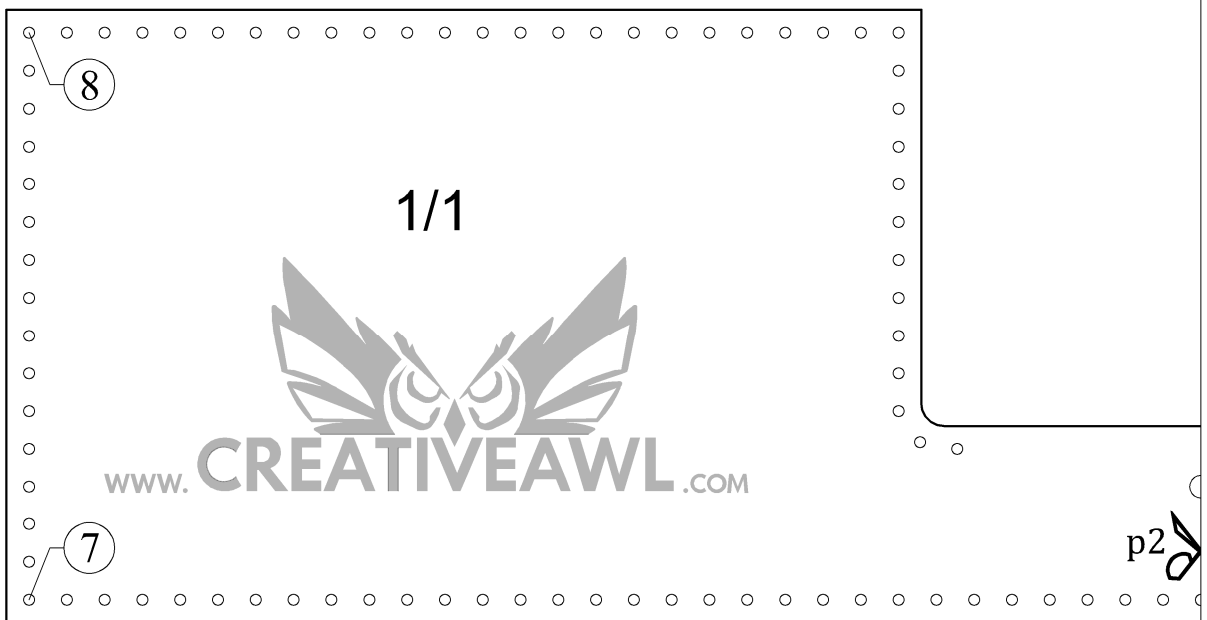

11 in
LETTER
8,5 in

A4

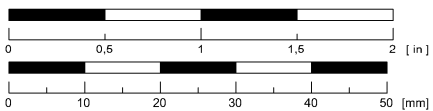

X - dopp kit

p1

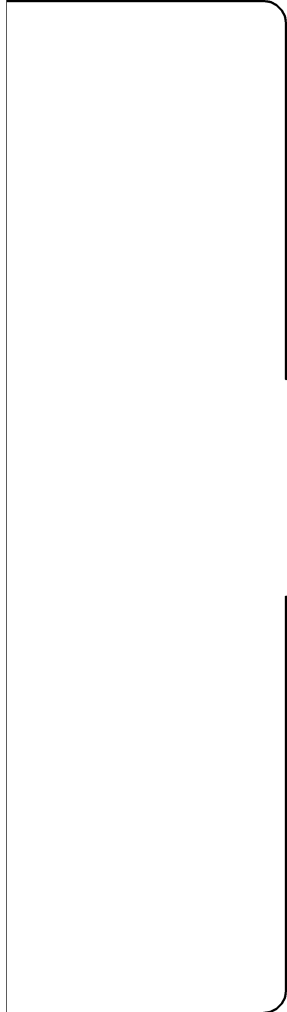
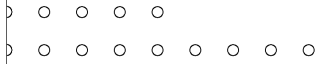

6

5

p2



2

1

11 in
LETTER
8,5 in

A4

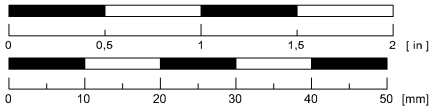

X - dopp kit



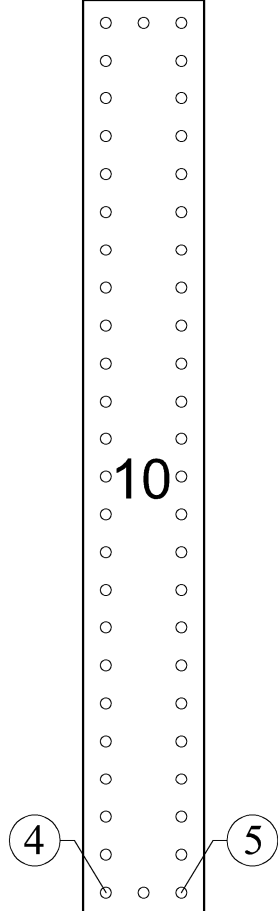
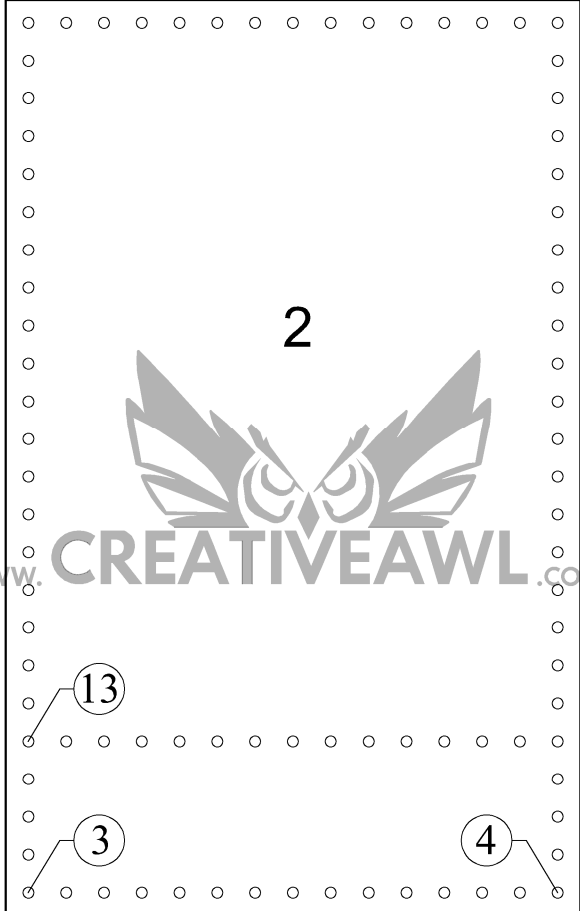
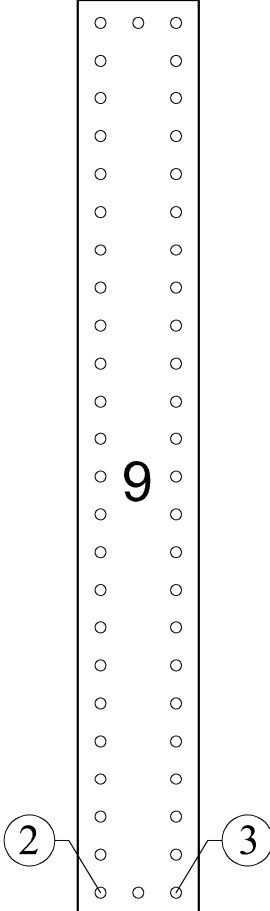
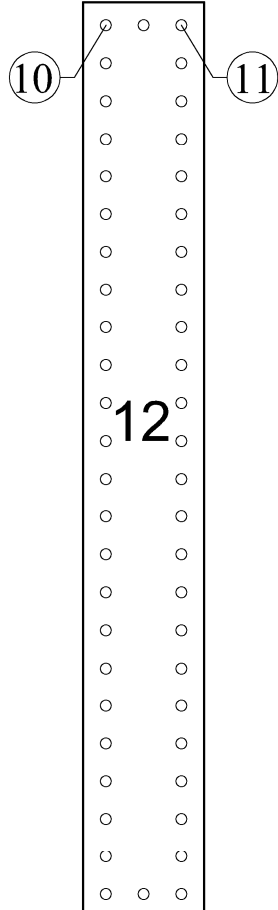
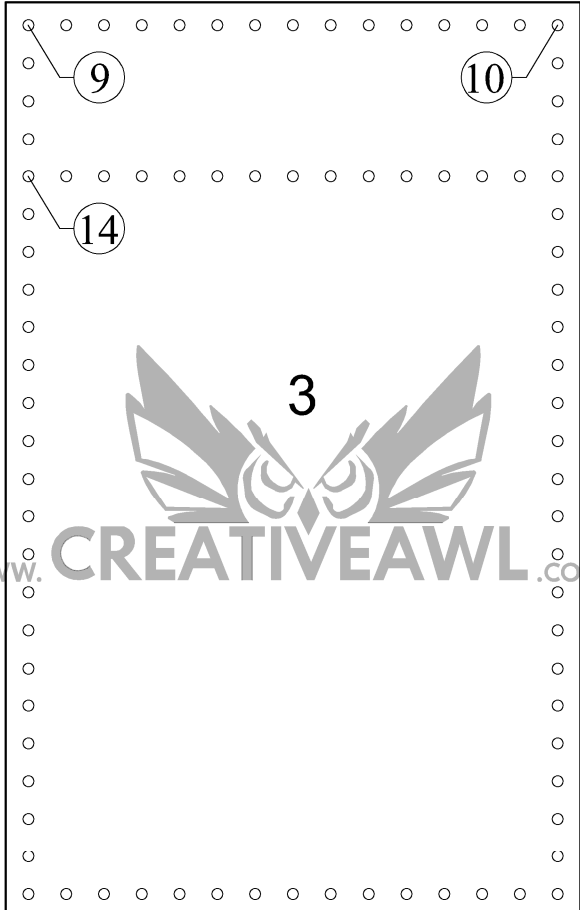
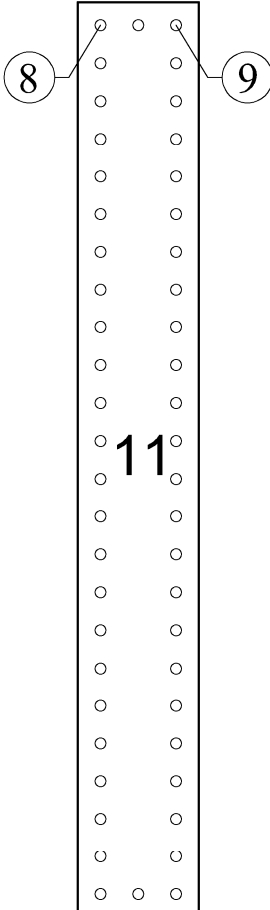

11 in
LETTER
8,5 in

A4

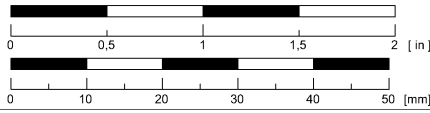

X - dopp kit

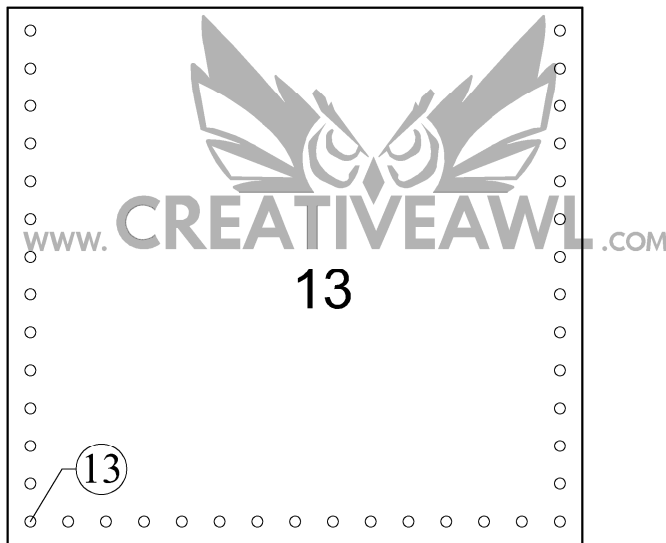
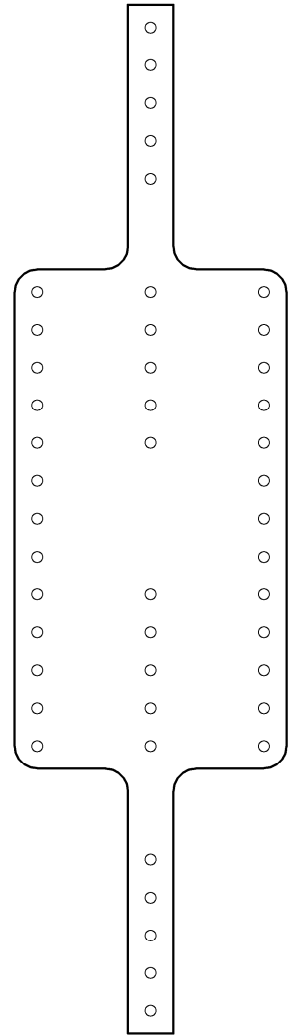
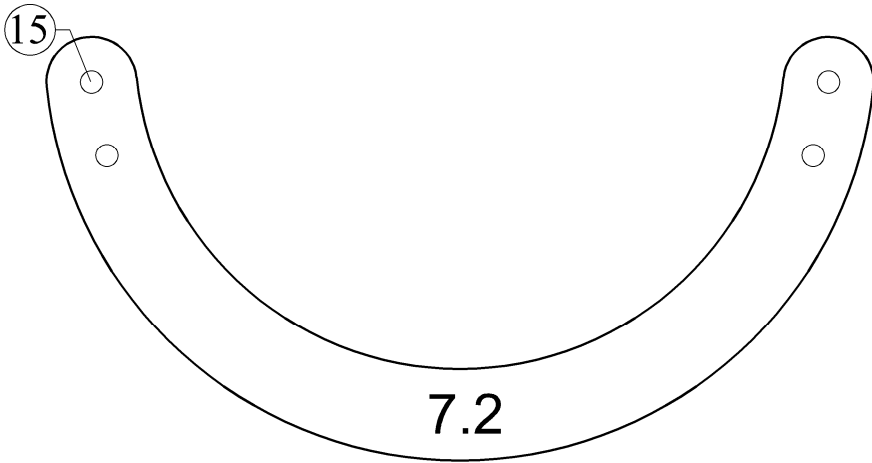
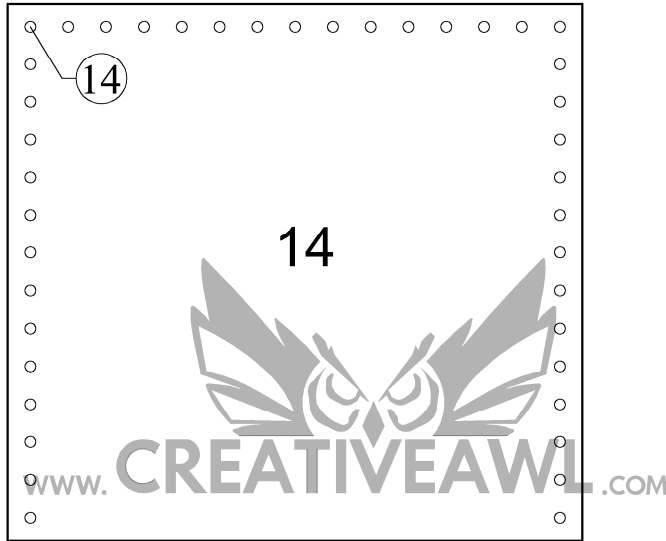

11 in
LETTER
8,5 in

A4

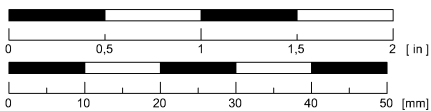

X - dopp kit

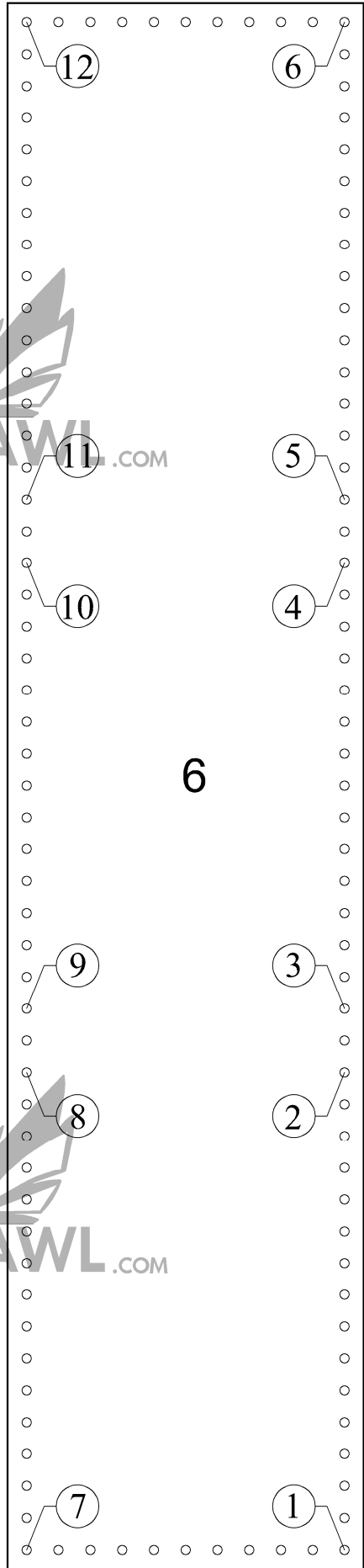
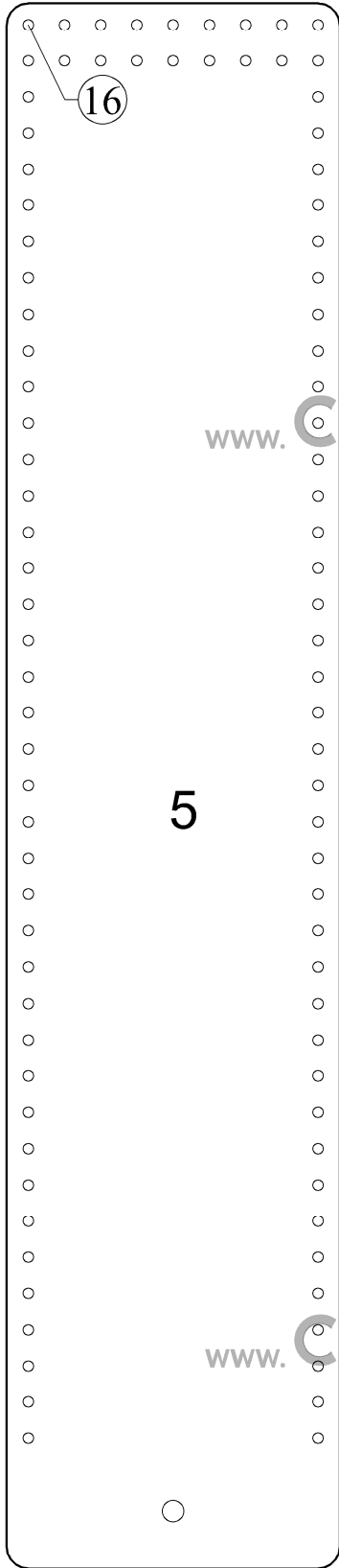

11 in
LETTER
8,5 in

A4

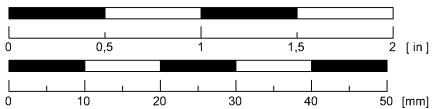

X - dopp kit

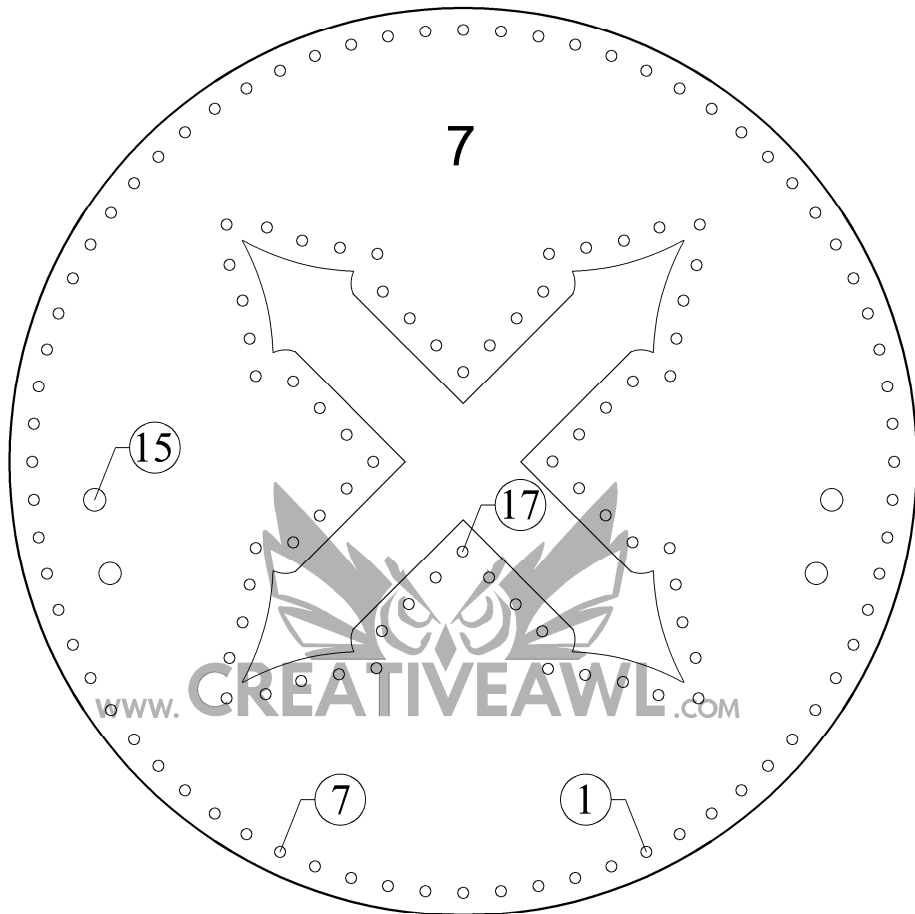
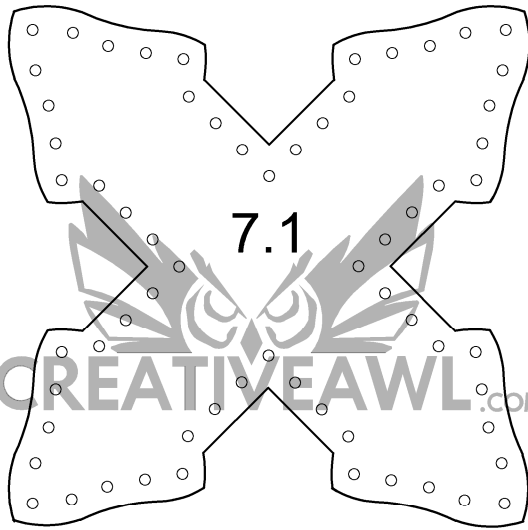

11 in
LETTER
8,5 in

A4

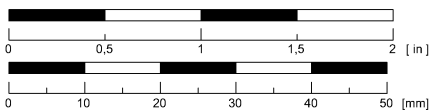

X - dopp kit

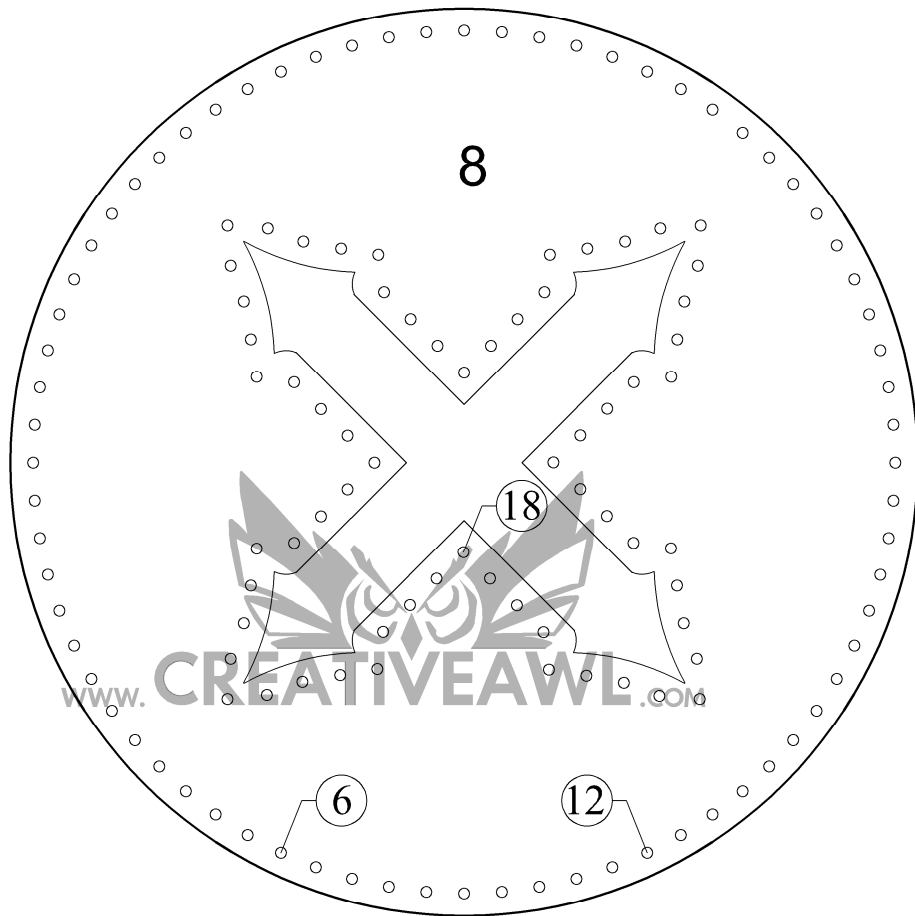
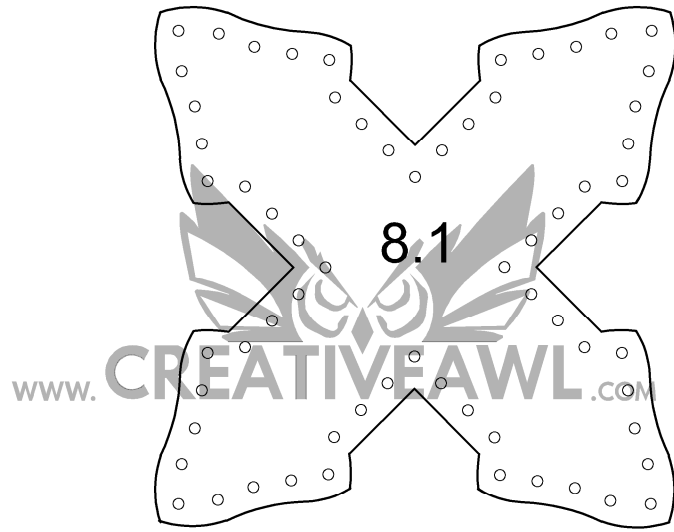

11 in
LETTER
8,5 in

A4

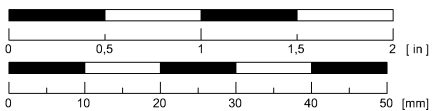

X - dopp kit