

Assembly instructions



Difficulty level: beginner
Completion Time 14-16 hours

Copyright Dieselpunk.ro 2019



NECESSARY TOOLS

B&W Printer

Copyright Dieselpunk.ro 2019



Scissors or a cutter



Hole Puncher (We recommend 1.5 mm sized holes for this build)

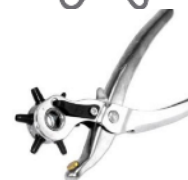

About 6 square feet of leather for the small one and 10 sq ft for the large bag. (We recommend a combination of 4-5 oz chrome tan and 7-8 oz veg tan leather for this build)



Thread and needles (We recommend 1 mm waxed thread for this build)



2 x 20 mm D-rings

Copyright Dieselpunk.ro 2019

You can get every piece of hardware you need for this bag and any of our other designs here:

<https://www.etsy.com/shop/TheLeatherRepublic>

Before you start working **please watch this short video** to see how to print and use your pattern correctly:

<https://youtu.be/-LfRFG5PtW0>

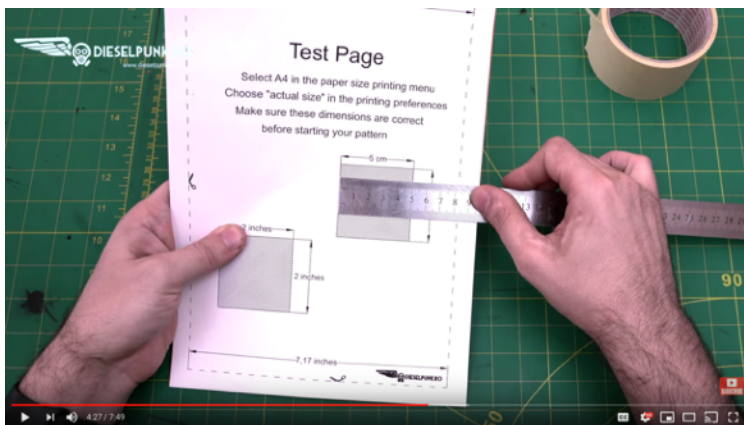

You will learn how to print at correct scale,

... how to assemble the large pieces of the pattern correctly ...

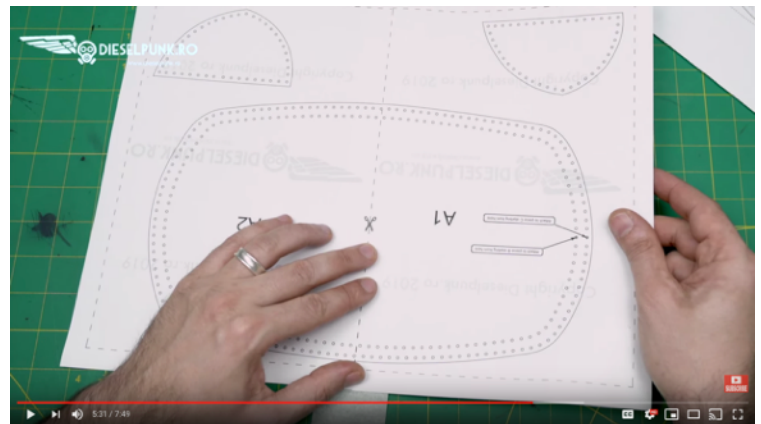

... and how to use the paper pattern to cut all the leather pieces you need for your design



PRINTING THE PATTERN

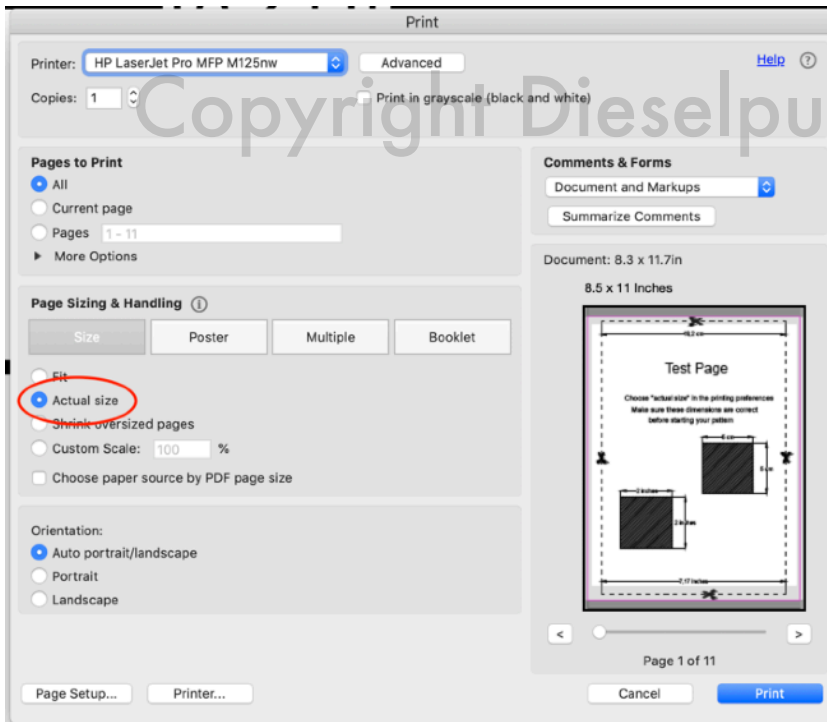

Set up your paper size to A4, Letter or Legal and **choose actual size** in the printer settings

Please access your instructional video here:

<https://youtu.be/w9IFFbcclrU>

Copyright Dieselpunk.ro 2019

Would love to see what you did, so please share or leave a review on



Stuck and need help? go ahead and send us a message
We are always happy to help

Thank you for constructing your bags with our patterns

To further help all our clients we created this FaceBook group for everyone to share ideas and stay up to date with the latest patterns available. (mention the order number to be approved immediately)

Please follow the link below to join.

<https://www.facebook.com/groups/1434028716724087/>



Best Regards
Tony

Copyright Dieselpunk.ro 2019

18,2 cm

Test Page

Choose "actual size" in the printing preferences
Make sure these dimensions are correct
before starting your pattern

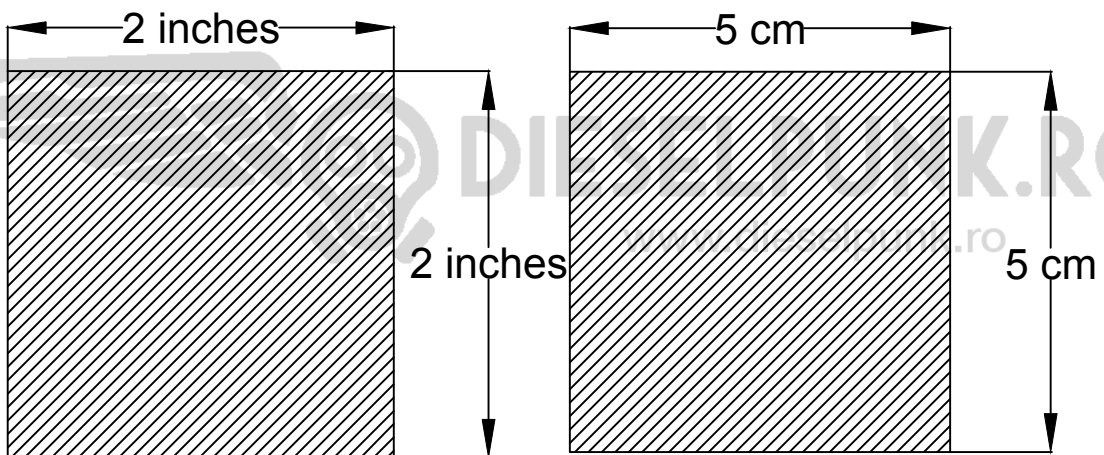

Copyright Dieselpunk.ro 2019

7,17 inches

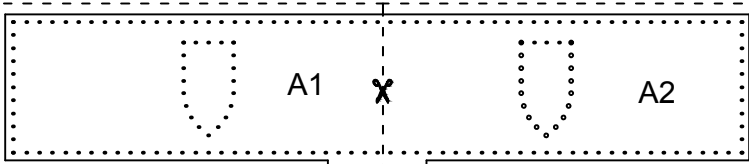

DESIGNED BY DIESELPUNK.RO

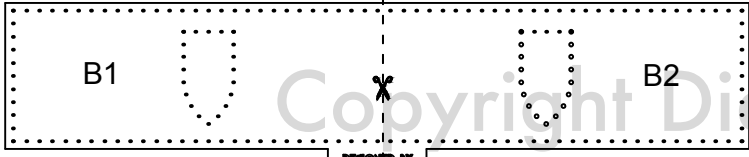

DESIGNED BY DIESELPUNK.RO

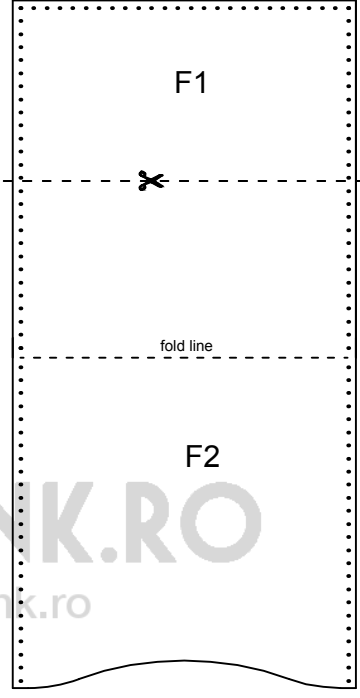
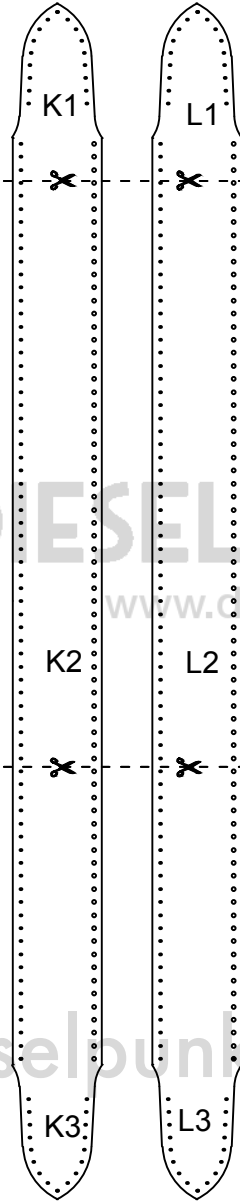
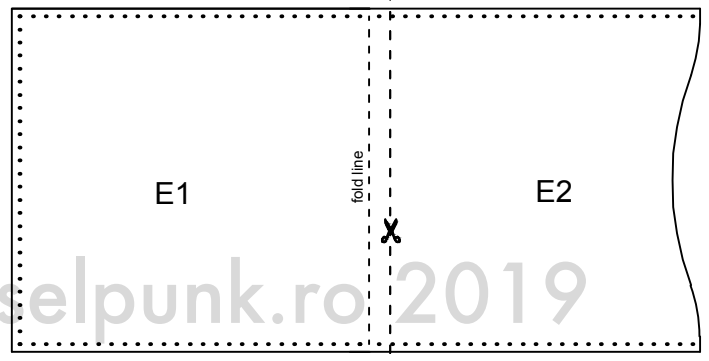
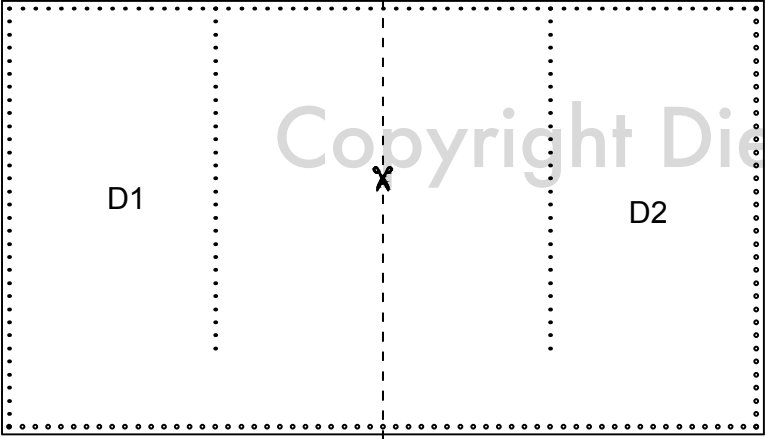
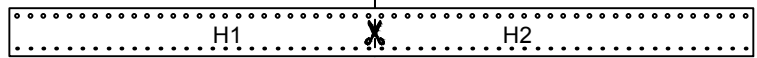
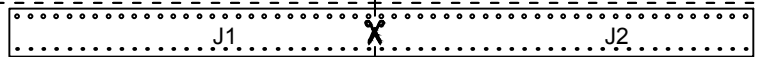
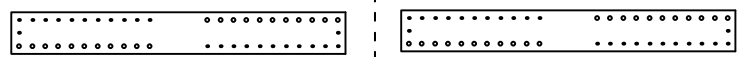
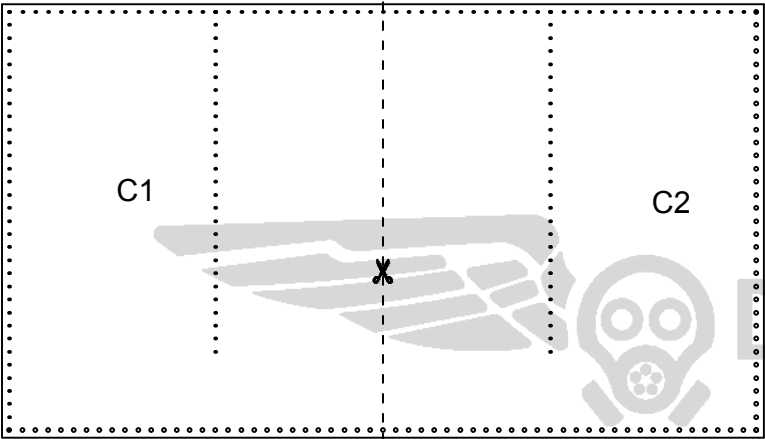
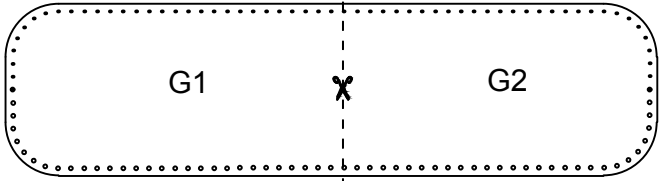

Copyright Dieselpunk.ro 2019

DIESELPUNK.RO
www.dieselpunk.ro

Copyright Dieselpunk.ro 2019

Small Size

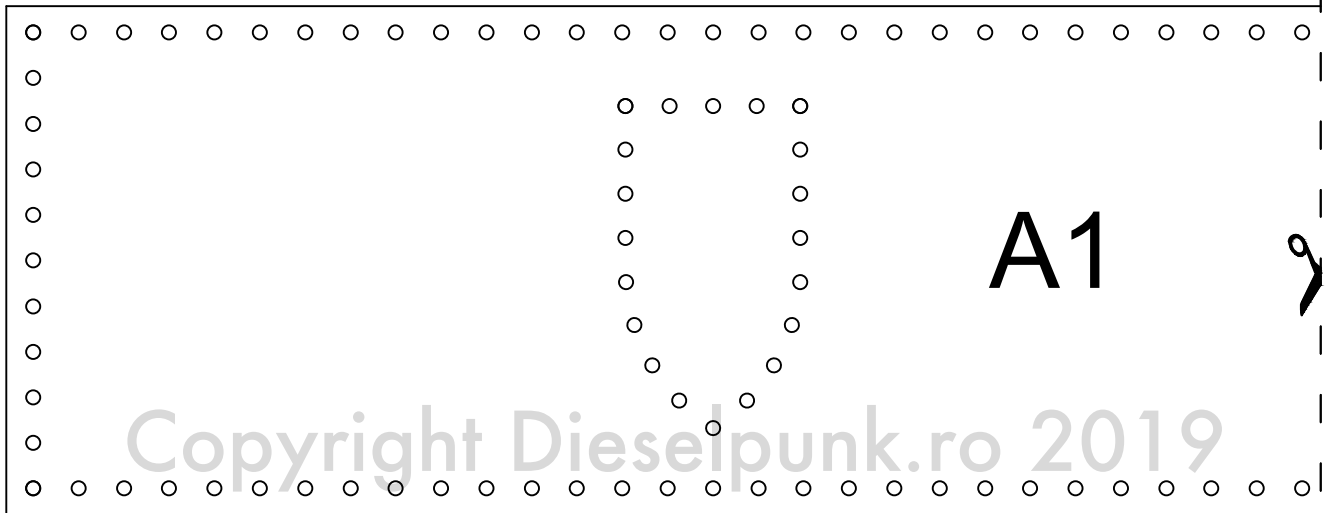

DESIGN
DIESELPUNK

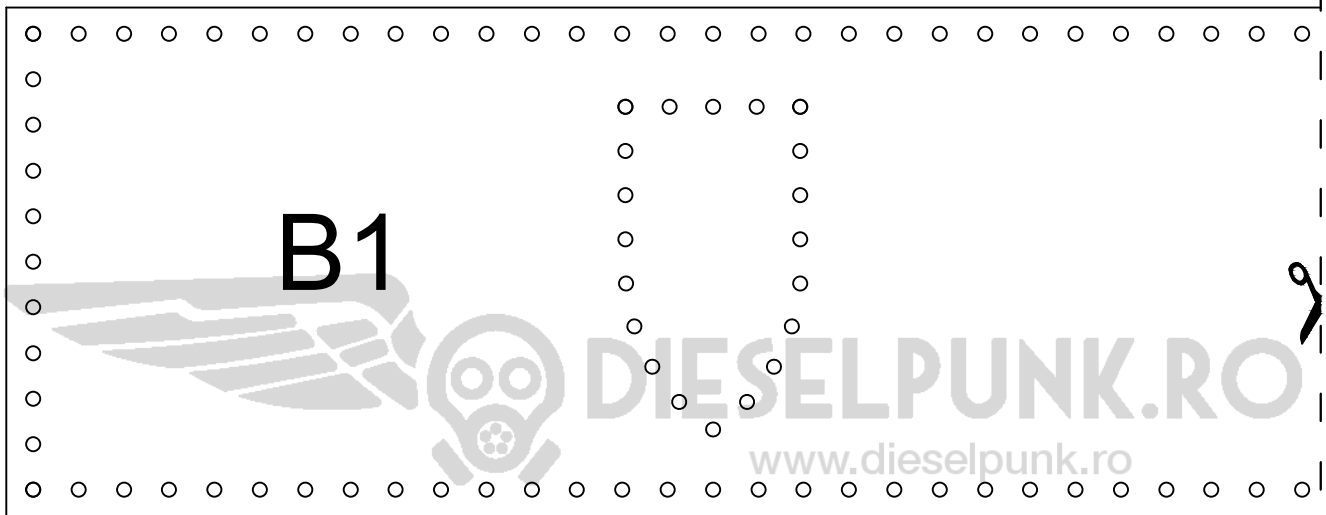

DESIGN
DIESELPUNK

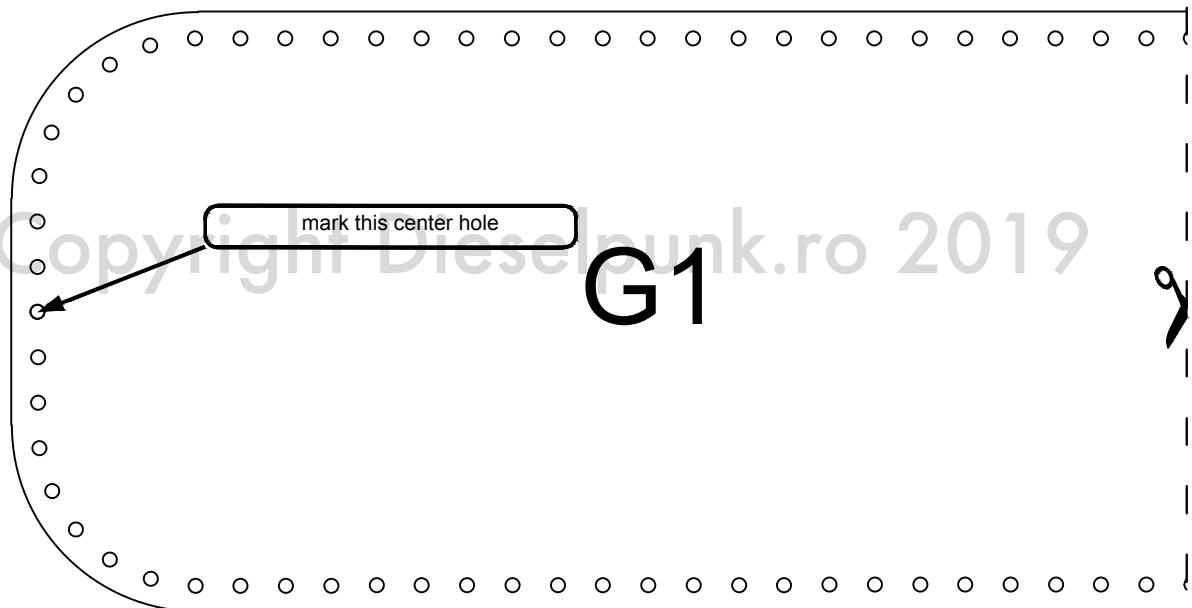

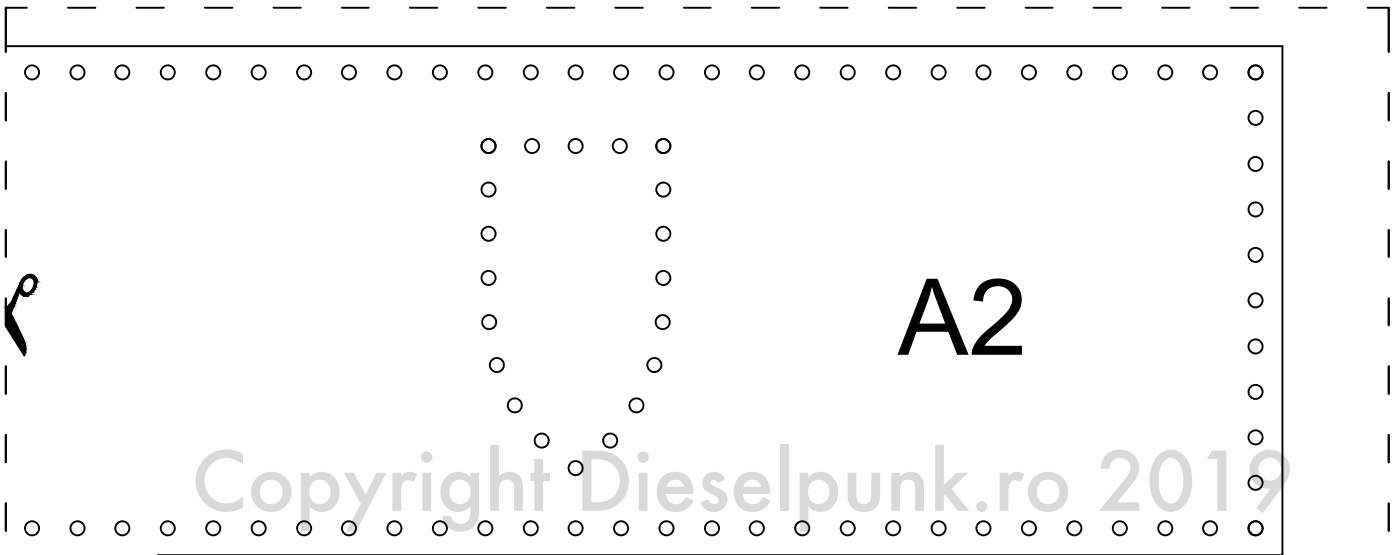

Copyright Dieselpunk.ro 2019

ED BY
INK.RO

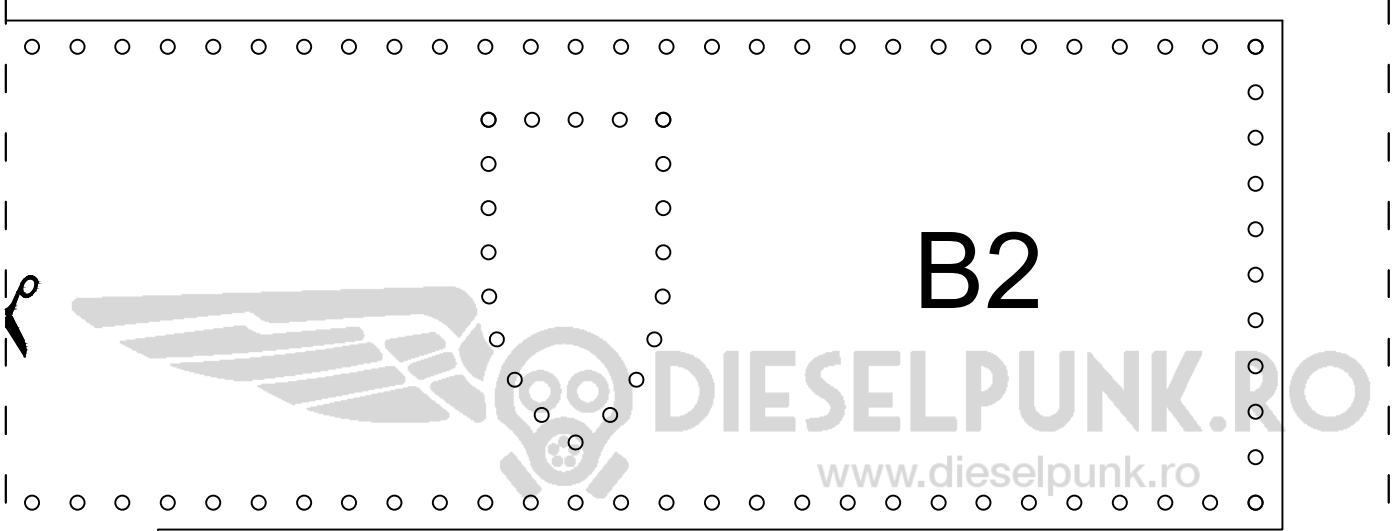

ED BY
INK.RO

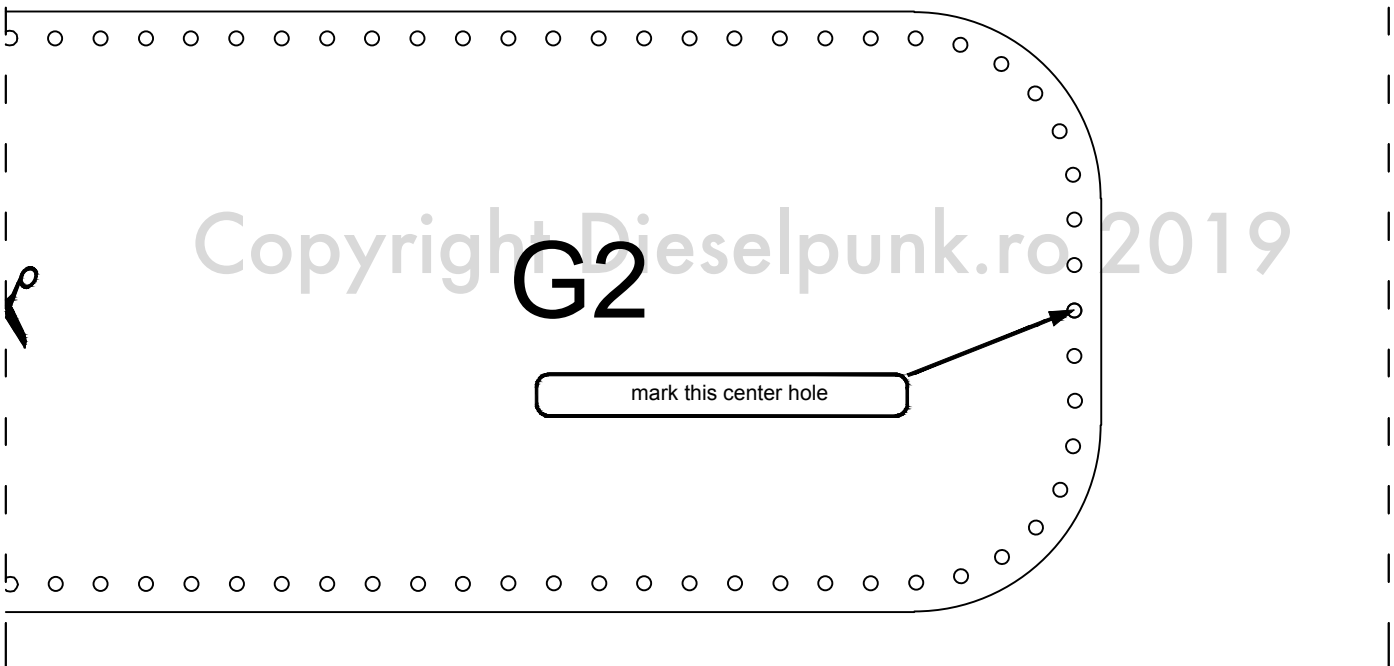

Copyright Dieselpunk.ro 2019

mark this center hole

Copyright Dieselpunk.ro 2019

E1

fold line



Copyright Dieselpunk.ro 2019

K1

L1

Copyright Dieselpunk.ro 2019

E2



DIESELPUNK.RO

www.dieselpunk.ro

Copyright Dieselpunk.ro 2019

F1



Copyright Dieselpunk.ro 2019

C1



DIESELPUNK.RO

www.dieselpunk.ro

Copyright Dieselpunk.ro 2019



Copyright Dieselpunk.ro 2019

C2



DIESELPUNK.RO

www.dieselpunk.ro

Copyright Dieselpunk.ro 2019



Copyright Dieselpunk.ro 2019

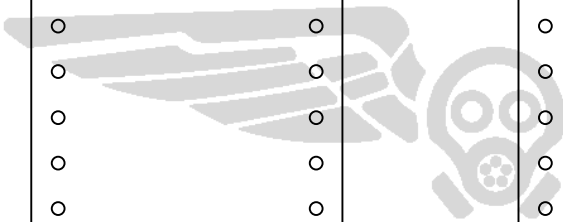

DIESELPUNK.RO

www.dieselpunk.ro

Copyright Dieselpunk.ro 2019

K2

L2

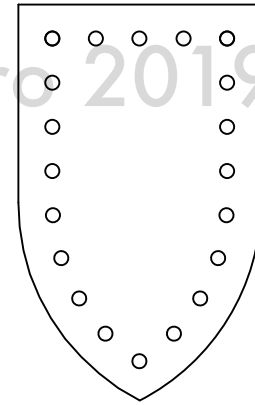
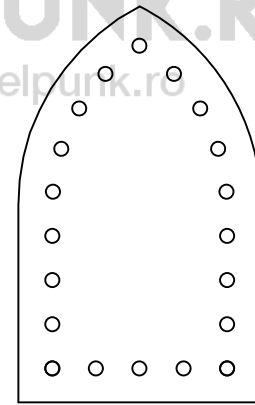
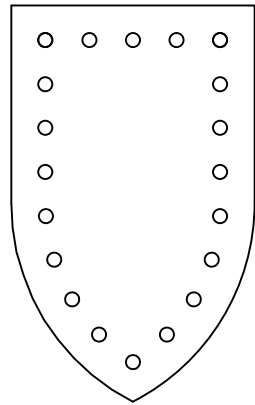
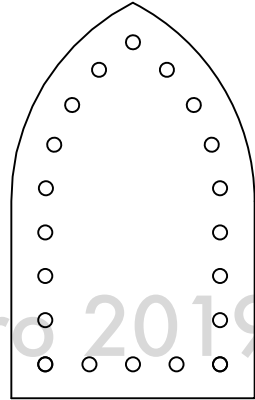



Copyright Dieselpunk.ro 2019

fold line

F2



DIESELPUNK.RO

www.dieselpunk.ro

Copyright Dieselpunk.ro 2019

J1

H1

Copyright Dieselpunk.ro 2019



DIESELPUNK.RO

www.dieselpunk.ro

Copyright Dieselpunk.ro 2019

J2

H2

Copyright Dieselpunk.ro 2019



DIESELPUNK.RO

www.dieselpunk.ro

D2

Copyright Dieselpunk.ro 2019

Copyright Dieselpunk.ro 2019



K3

L3



DIESELPUNK.RO

www.dieselpunk.ro

Copyright Dieselpunk.ro 2019

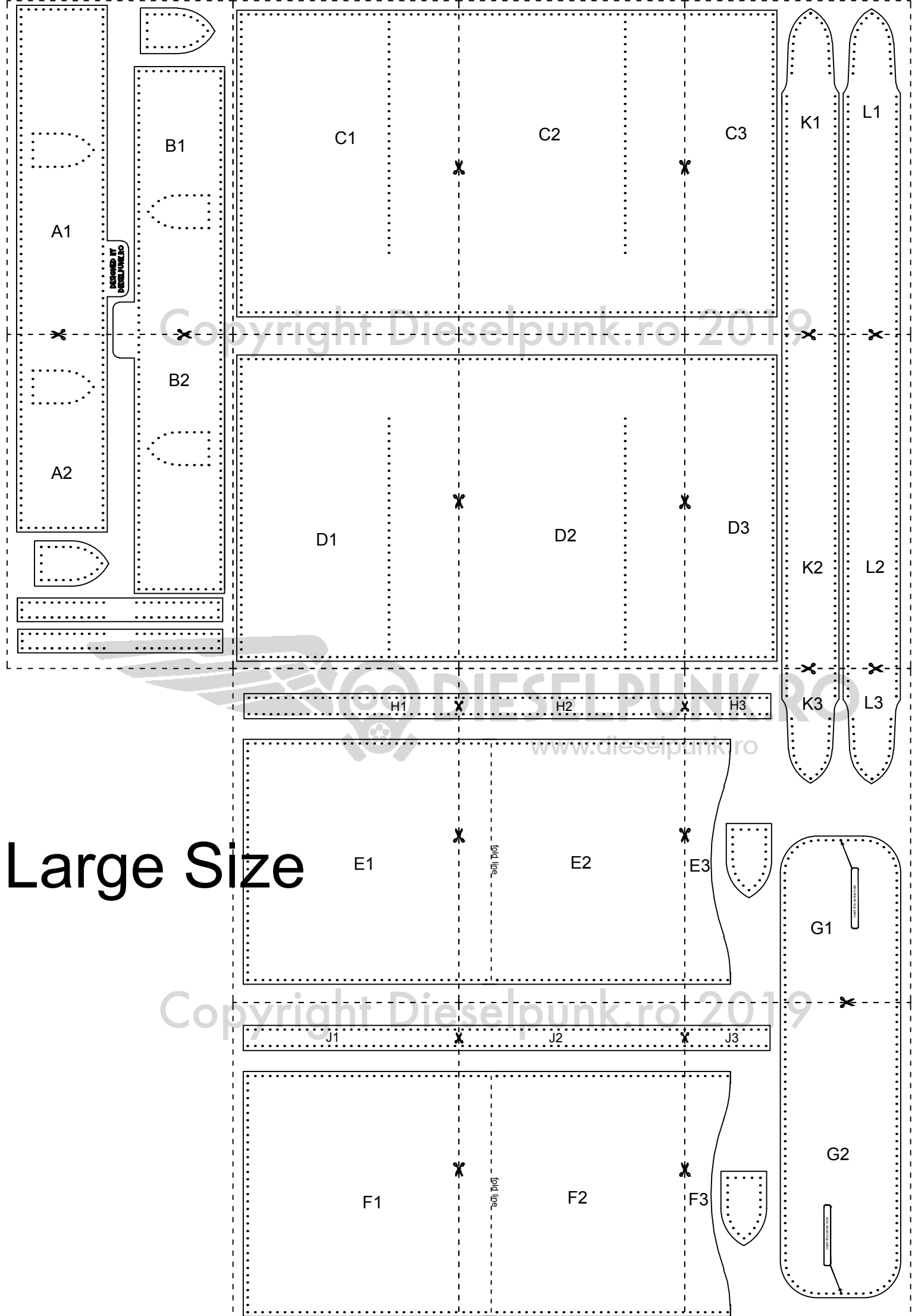

ascundeți
pesele

Large Size

Copyright Dieselpunk.ro 2019

Copyright Dieselpunk.ro 2019

www.dieselpunk.ro

fold line

fold line

fold line

fold line

Copyright Dieselpunk.ro 2019

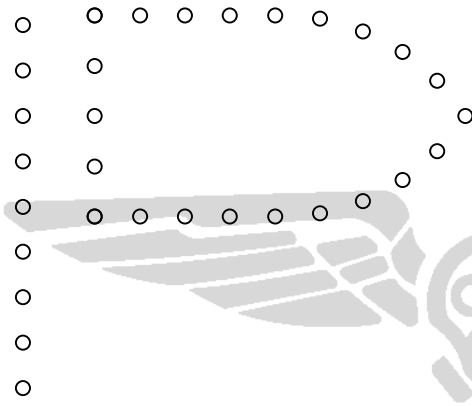
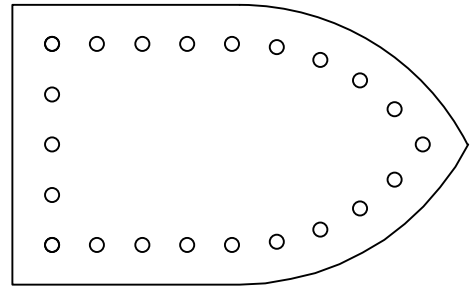

A1

B1

DESIGNED BY
DIESELPUNK.RO

Copyright Dieselpunk.ro 2019

www.dieselpunk.ro

DIESELPUNK.RO



Copyright Dieselpunk.ro 2019

C1



DIESELPUNK.RO

www.dieselpunk.ro

Copyright Dieselpunk.ro 2019

Copyright Dieselpunk.ro 2019

C2



DIESELPUNK.RO

www.dieselpunk.ro

Copyright Dieselpunk.ro 2019

Copyright Dieselpunk.ro 2019

C3

K1

L1

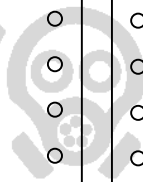

DIESELPUNK.RO

www.dieselpunk.ro

Copyright Dieselpunk.ro 2019

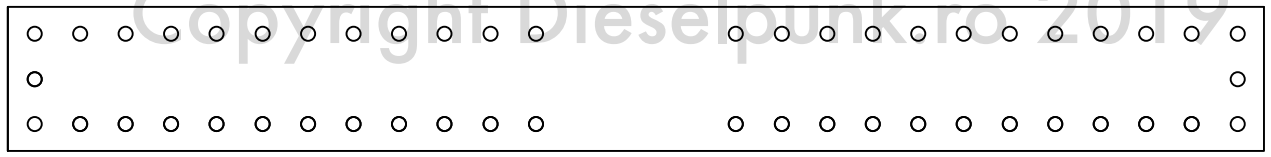
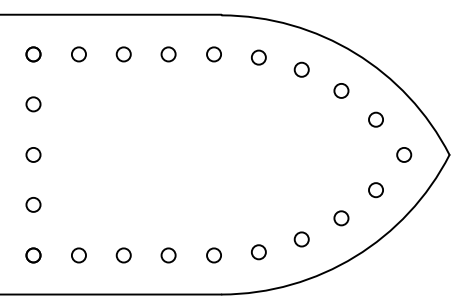
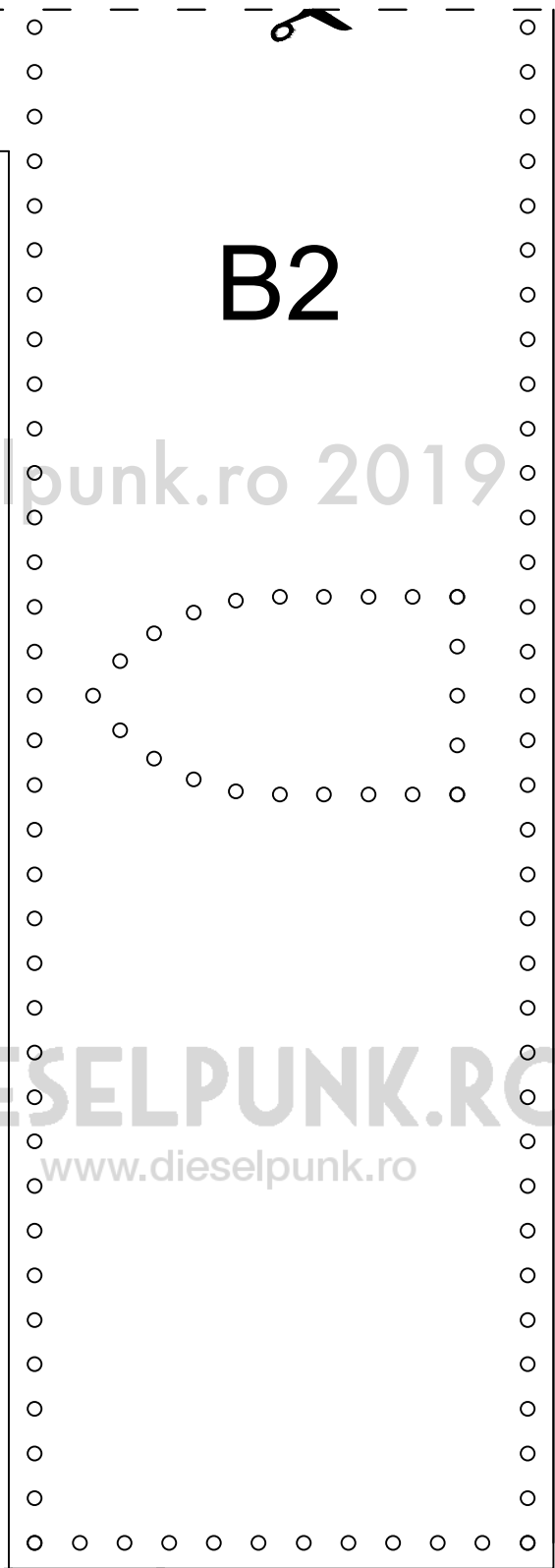
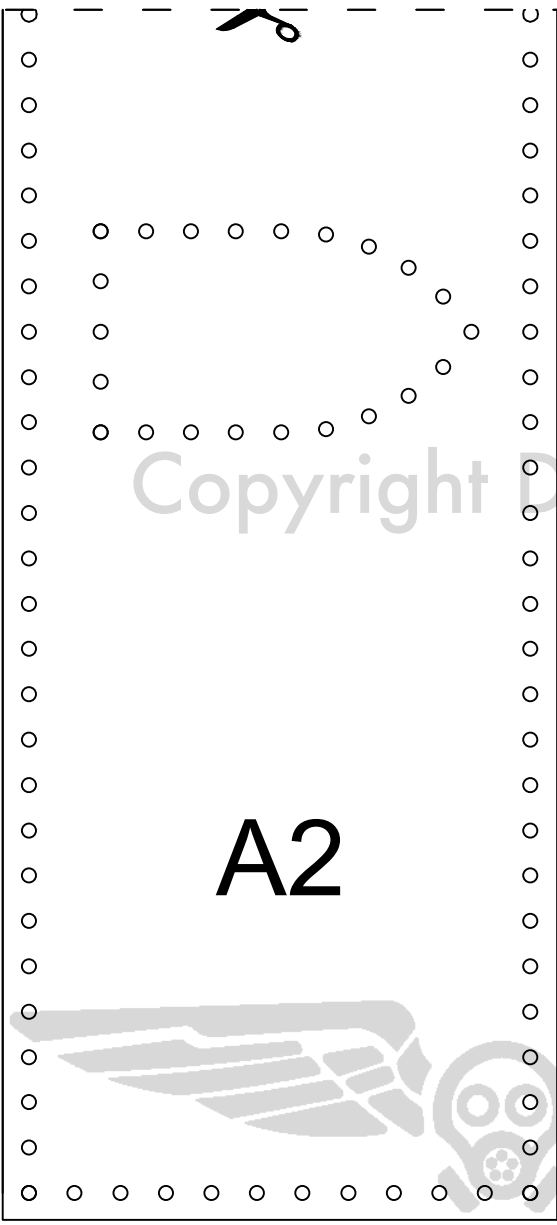

Copyright Dieselpunk.ro 2019

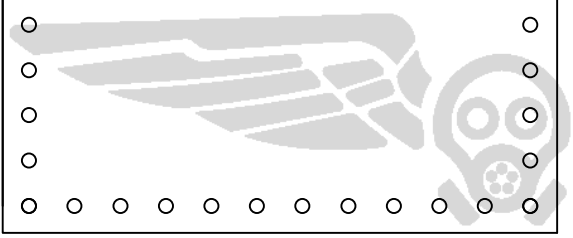

DIESELPUNK.RO
www.dieselpunk.ro

Copyright Dieselpunk.ro 2019



DIESELPUNK.RO

www.dieselpunk.ro

Copyright Dieselpunk.ro 2019



Copyright Dieselpunk.ro 2019



Copyright Dieselpunk.ro 2019

Copyright Dieselpunk.ro 2019



D3

K2

L2

Copyright Dieselpunk.ro 2019

H1



Copyright Dieselpunk.ro 2019



DIESELPUNK.RO

E1 www.dieselpunk.ro



Copyright Dieselpunk.ro 2019

H2

Copyright Dieselpunk.ro 2019

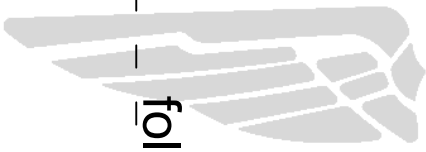

fold line



DIESELPUNK.RO

E2 www.dieselpunk.ro

Copyright Dieselpunk.ro 2019

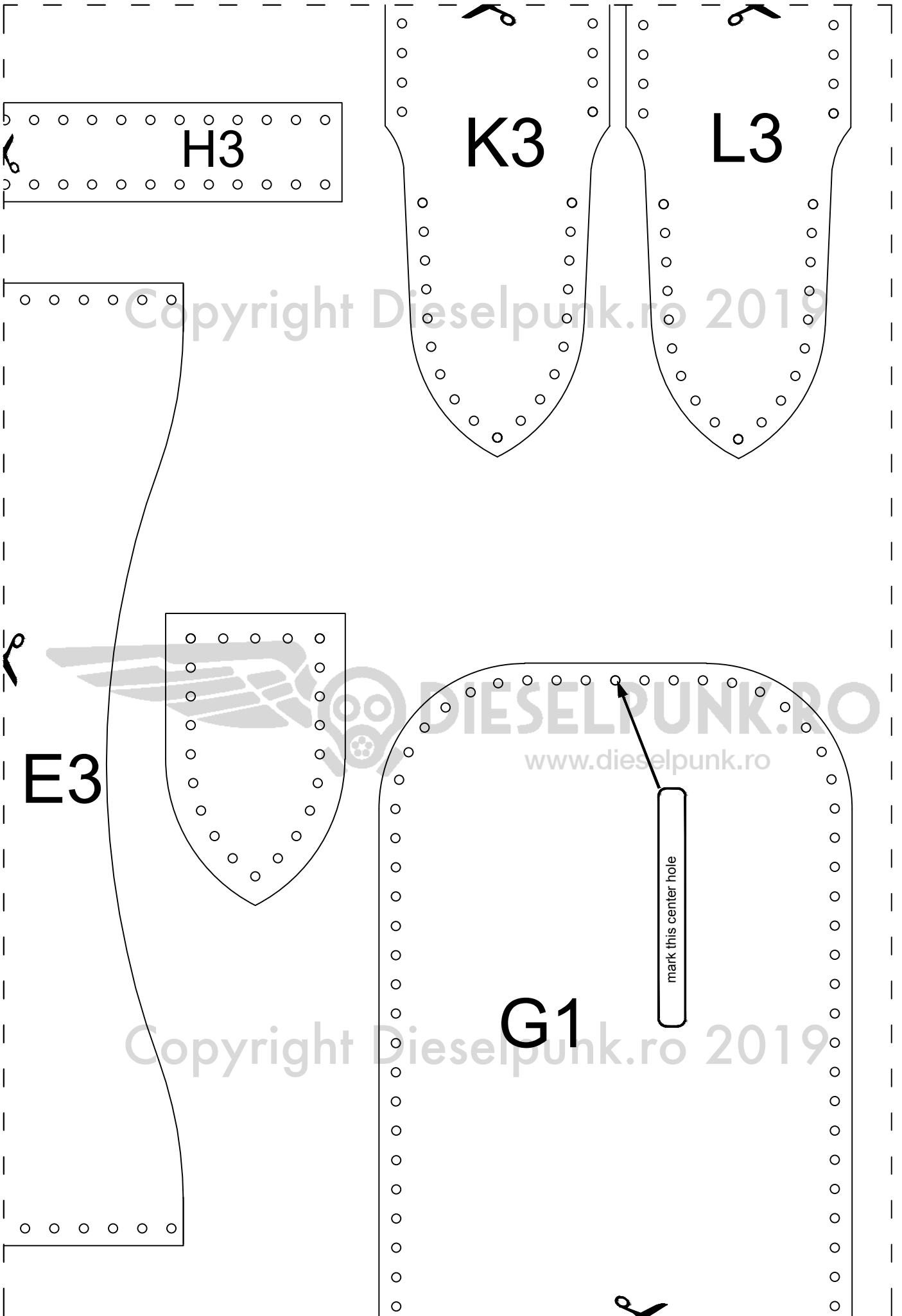

J1

Copyright Dieselpunk.ro 2019



DIESELPUNK.RO

www.dieselpunk.ro

F1

Copyright Dieselpunk.ro 2019

J2

Copyright Dieselpunk.ro 2019



fold line



DIESELPUNK.RO

F2

www.dieselpunk.ro

Copyright Dieselpunk.ro 2019

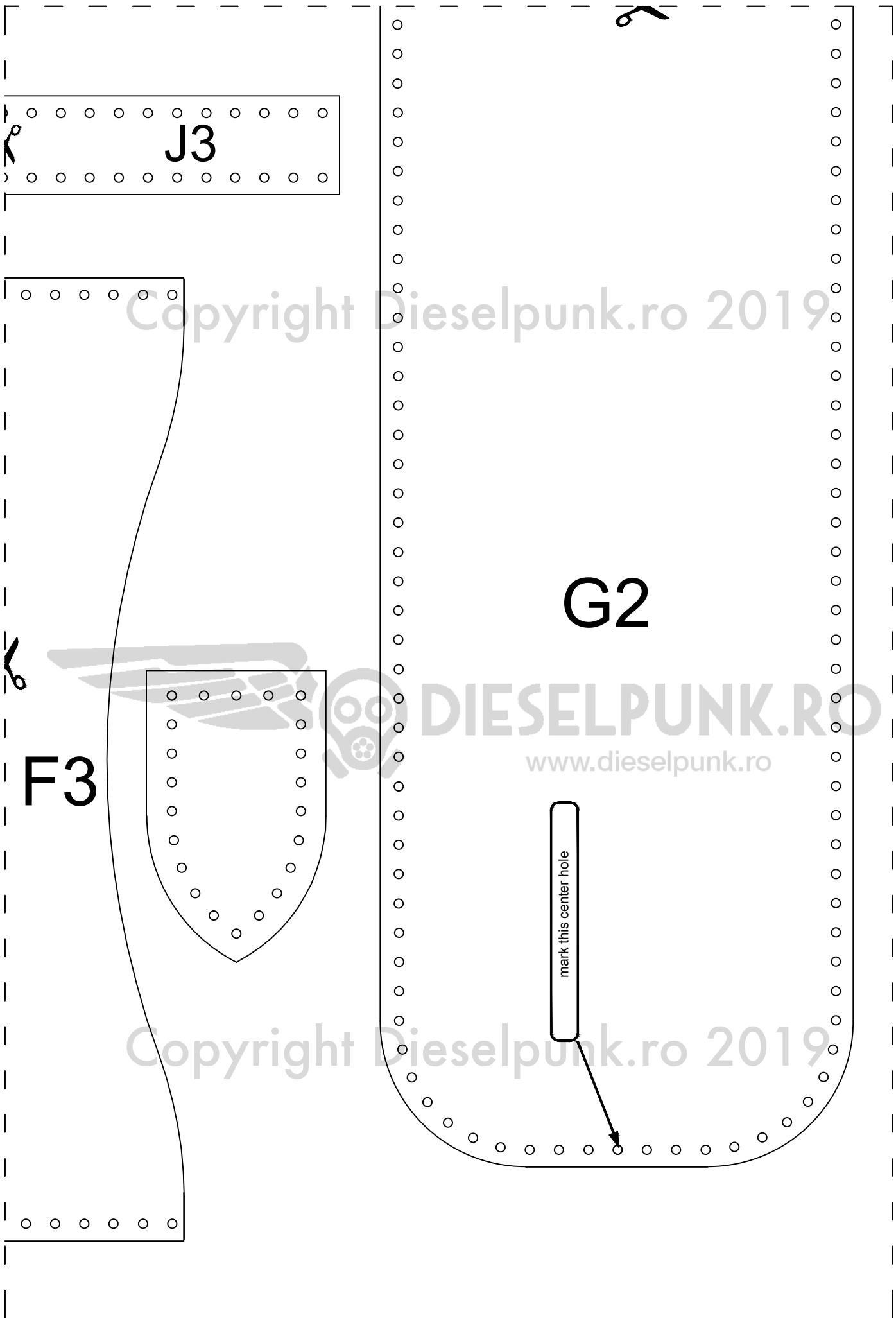

J3

G2

F3

DIESELPUNK.RO

www.dieselpunk.ro

mark this center hole

Copyright Dieselpunk.ro 2019

Copyright Dieselpunk.ro 2019

Copyright Advisory

Copyright Dieselpunk.ro 2019

YOU CAN SELL any items made with my patterns on your own web site or in a brick and mortar shop, at conventions, fairs and so forth without any problem as long as you don't sell more than 10 of each design each year.

If you want to sell them on Etsy.com I will require you buy my pattern again each time you make a sale to cover my designer rights*

*Note that I do not police this rules and I only rely on the honor system to get the due credit.

www.dieselpunk.ro

However if I feel these rules are abused I may choose to take further action within the copyright and the DMCA international law

Copyright Dieselpunk.ro 2019

THESE PATTERNS ARE NOT TO BE
RESOLD OR SHARED FOR FREE
UNDER ANY CIRCUMSTANCES.