THE "DOKTOR" BAGS

Difficulty level: intermediate

Completion time : 12-18 hours



MATERIALS LIST - METAL FRAME DESIGN

- **Approx 4 square feet of 4-6 oz chrome tan leather**
- **Approx 4 square feet of 6-8 oz vegetable tanned leather**
- **1 mm waxed thread and needles**
- **6 bottom studs or tiny metal feet (9 mm rapid rivets can also work)**
- **2 x 41 cm or 16.5 inches long pieces of rope (9 mm thick)**
- **18 x 30 cm or 7.1 x 11.8 inches metal frame closure (9 mm thick)**

MATERIALS LIST - ZIPPER DESIGN

- **Approx 4 square feet of 4-6 oz chrome tan leather**
- **Approx 4 square feet of 6-8 oz vegetable tanned leather**
- **1 mm waxed thread and needles**
- **6 bottom studs or tiny metal feet (9 mm rapid rivets can also work)**
- **2 x 41 cm or 16.5 inches long pieces of rope (9 mm thick)**
- **40 cm or 15.75 inches long nr. 5 zipper**
- **8 x 9 mm rapid rivets**
- **2 x 20 mm buckles**

MATERIALS LIST - INSIDE DIVIDER

- **Approx 3.5 square feet of 6-8 oz vegetable tanned leather**

PRINTING THE PATTERN

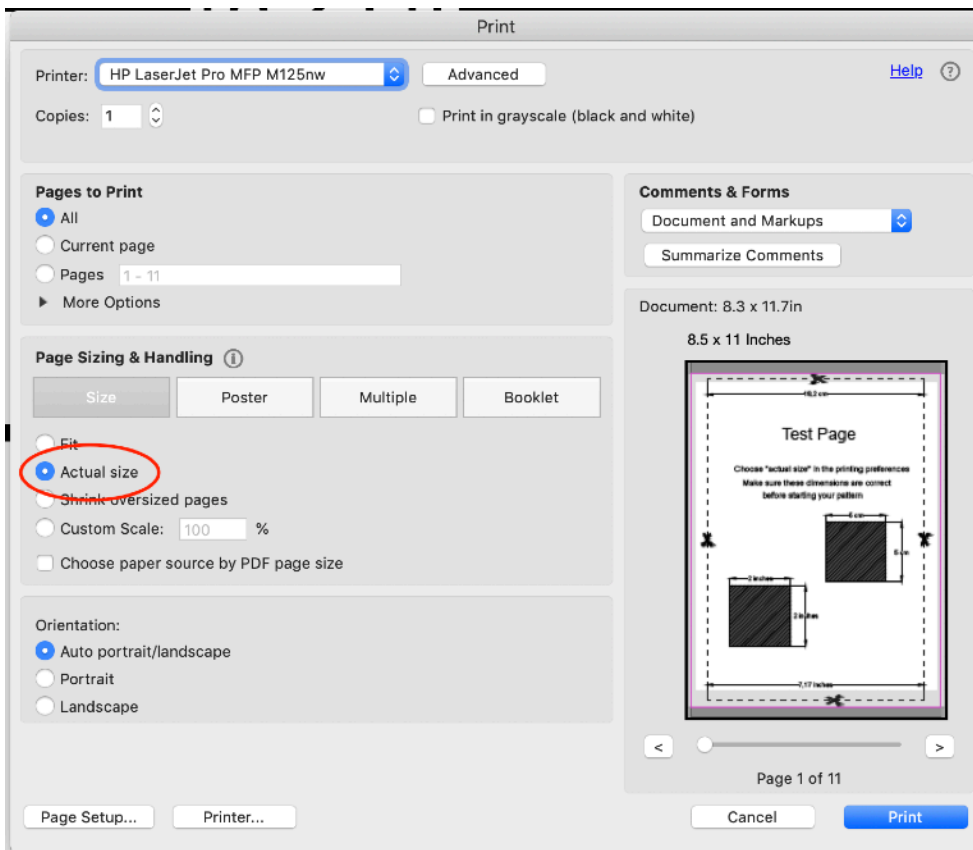

Set up your paper size to A4, Letter or Legal and **choose actual size** in the printer settings

More info on how to download, print and assemble our patterns correctly here ==> <https://youtu.be/-LrFG5PtW0>

We made a step by step tutorial of the entire build process for these bags and you should definitely watch it before you start your build.

access your instructional video here:



<https://youtu.be/4cq-IYGoutM>



Stuck and need help? go ahead and send us a message
We are always happy to help

To further help all our clients we created this FaceBook group for everyone to share ideas and stay up to date with the latest patterns available. (mention the order number to be approved immediately)

Please follow the link below to join.

<https://www.facebook.com/groups/1434028716724087/>



18,2 cm

Test Page

Select A4, letter or legal in the paper size printing menu
Choose "actual size" in the printing preferences

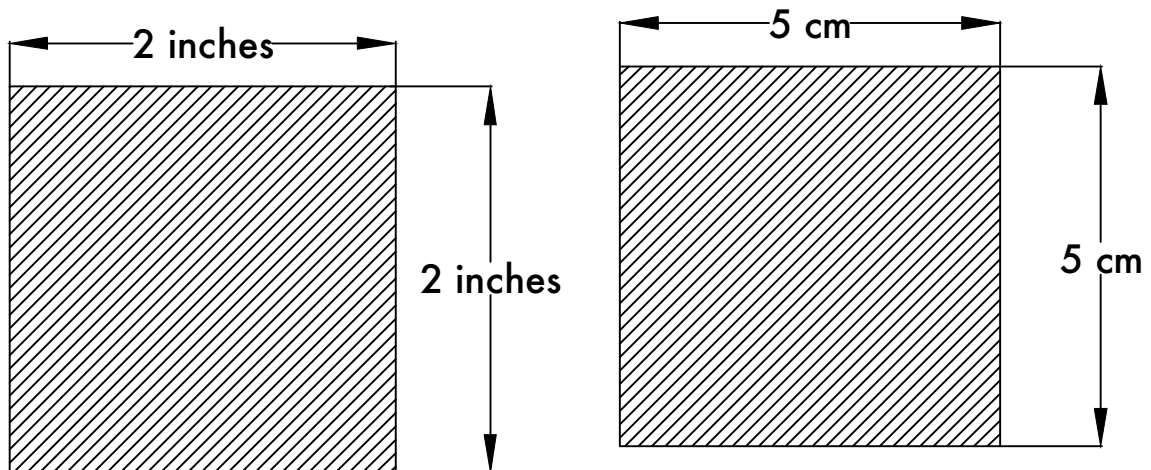

Copyright Advisory

This design is the property of Dieselpunk.ro and can be used under the terms stated below:

YOU CAN SELL any items made with this pattern on your own web site or in a brick and mortar shop, at conventions, fairs and so forth as long as you don't sell more than 10 of each design each year.

THESE PATTERNS ARE NOT TO BE RESOLD OR SHARED FOR FREE UNDER ANY CIRCUMSTANCES.

© 2022 Dieselpunk.ro All Rights Reserved

7,17 inches

The "Doktor" metal frame design



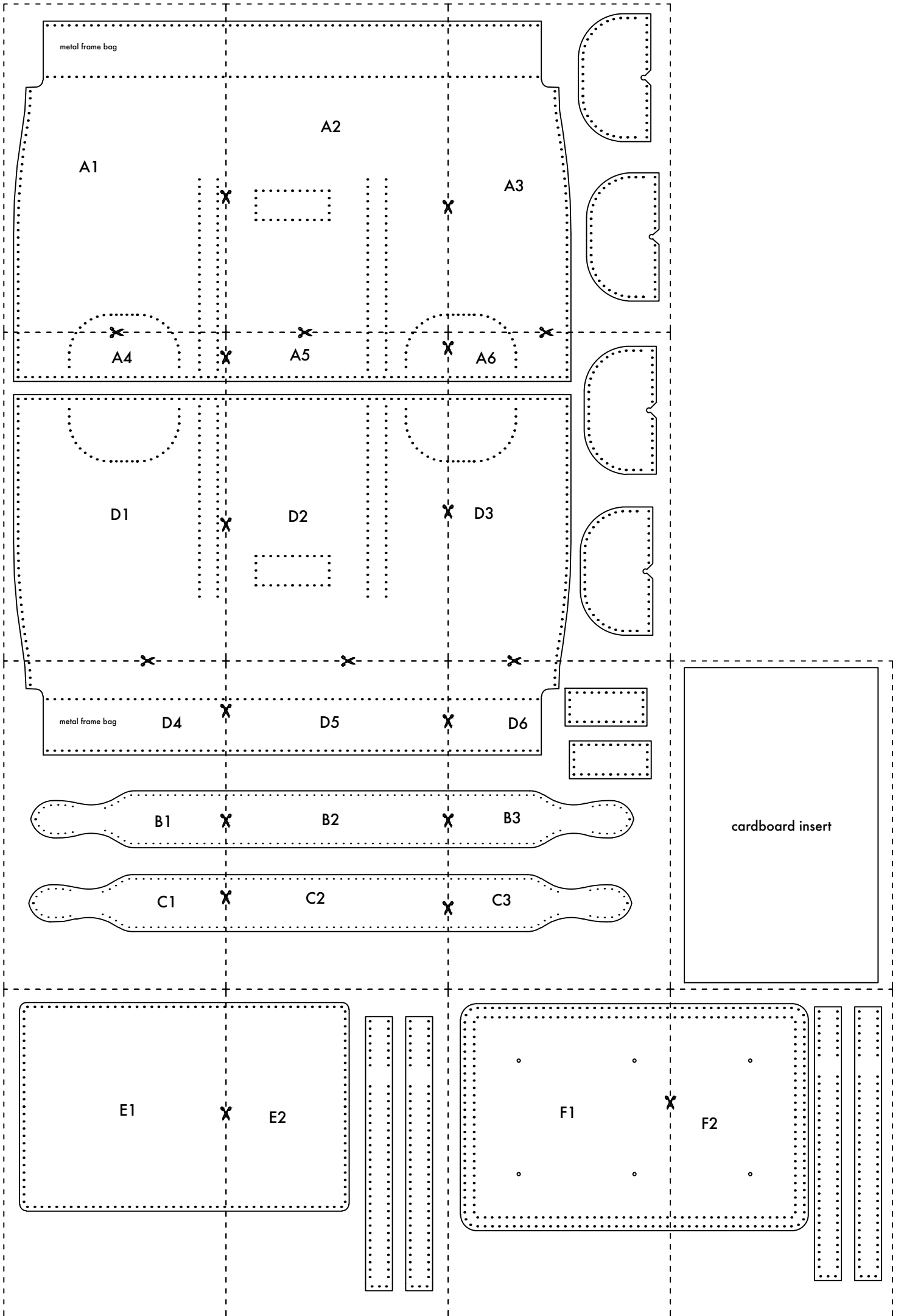

metal frame bag

A1



A2

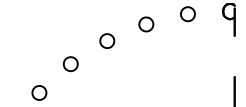
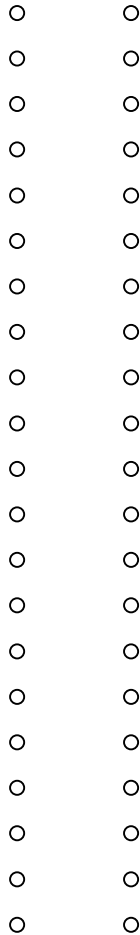
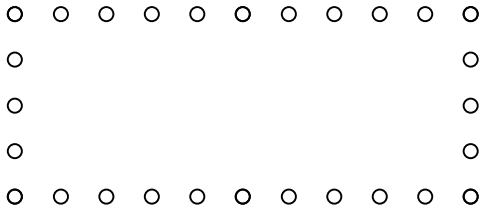

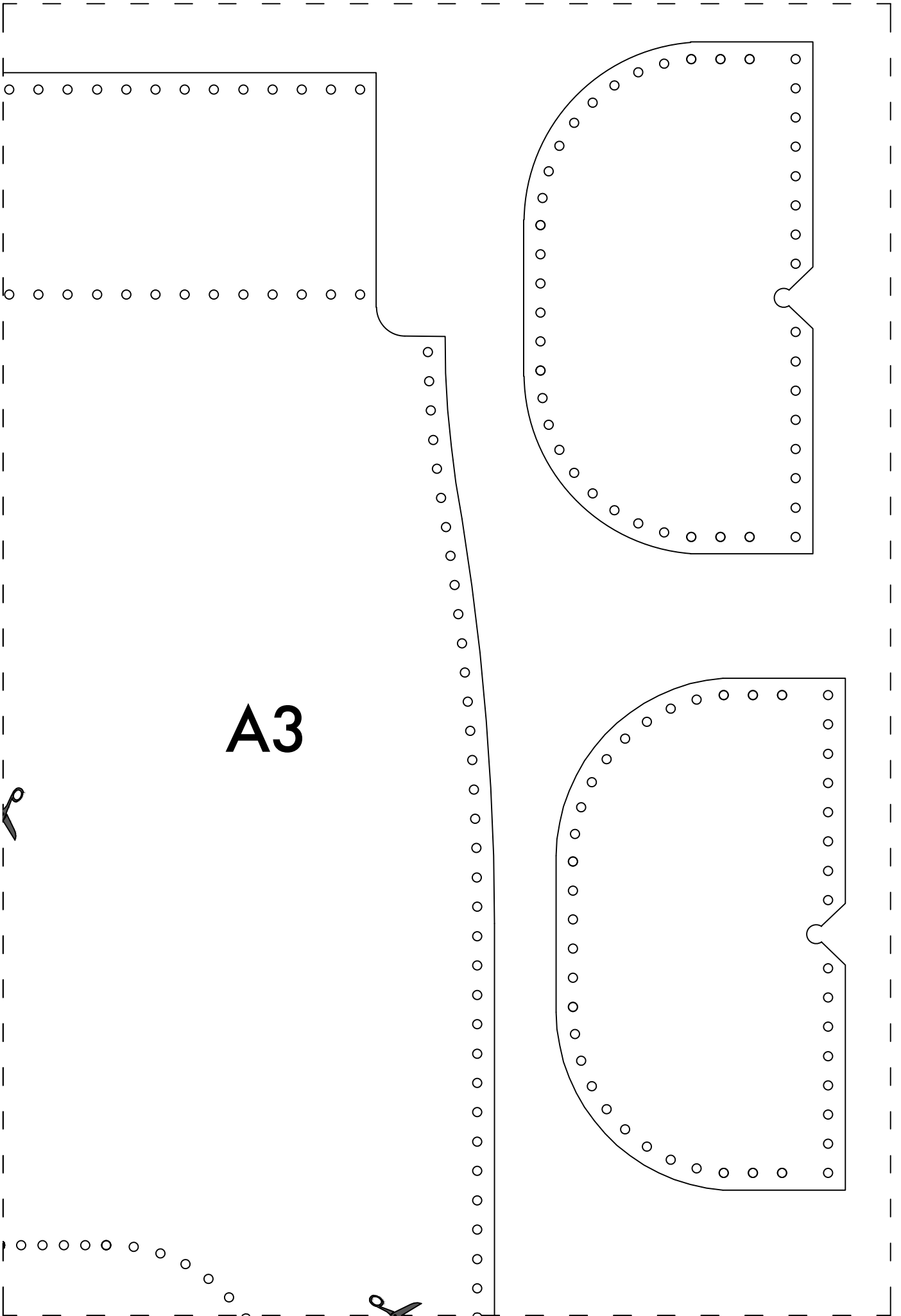

A3

A4



D1



A5

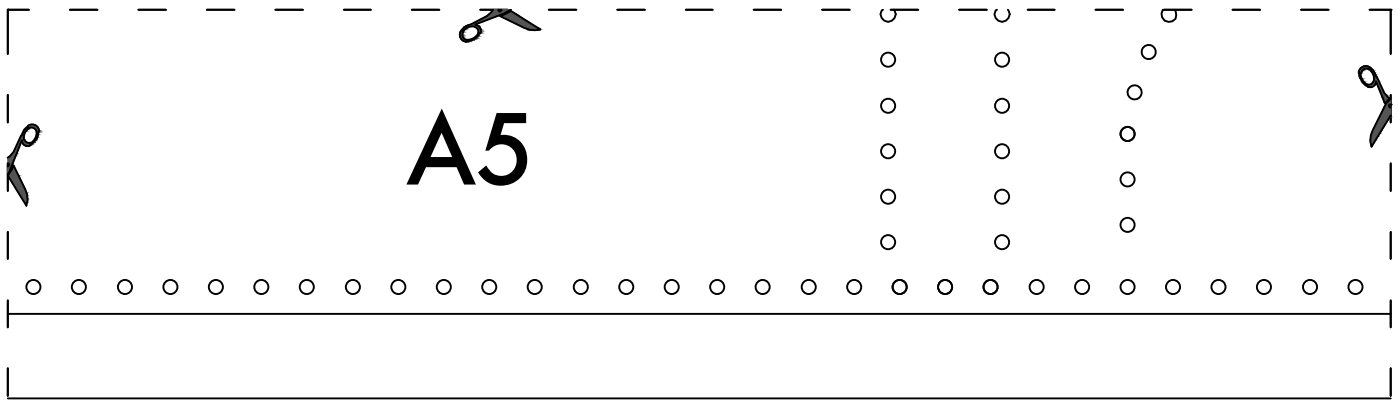

D2

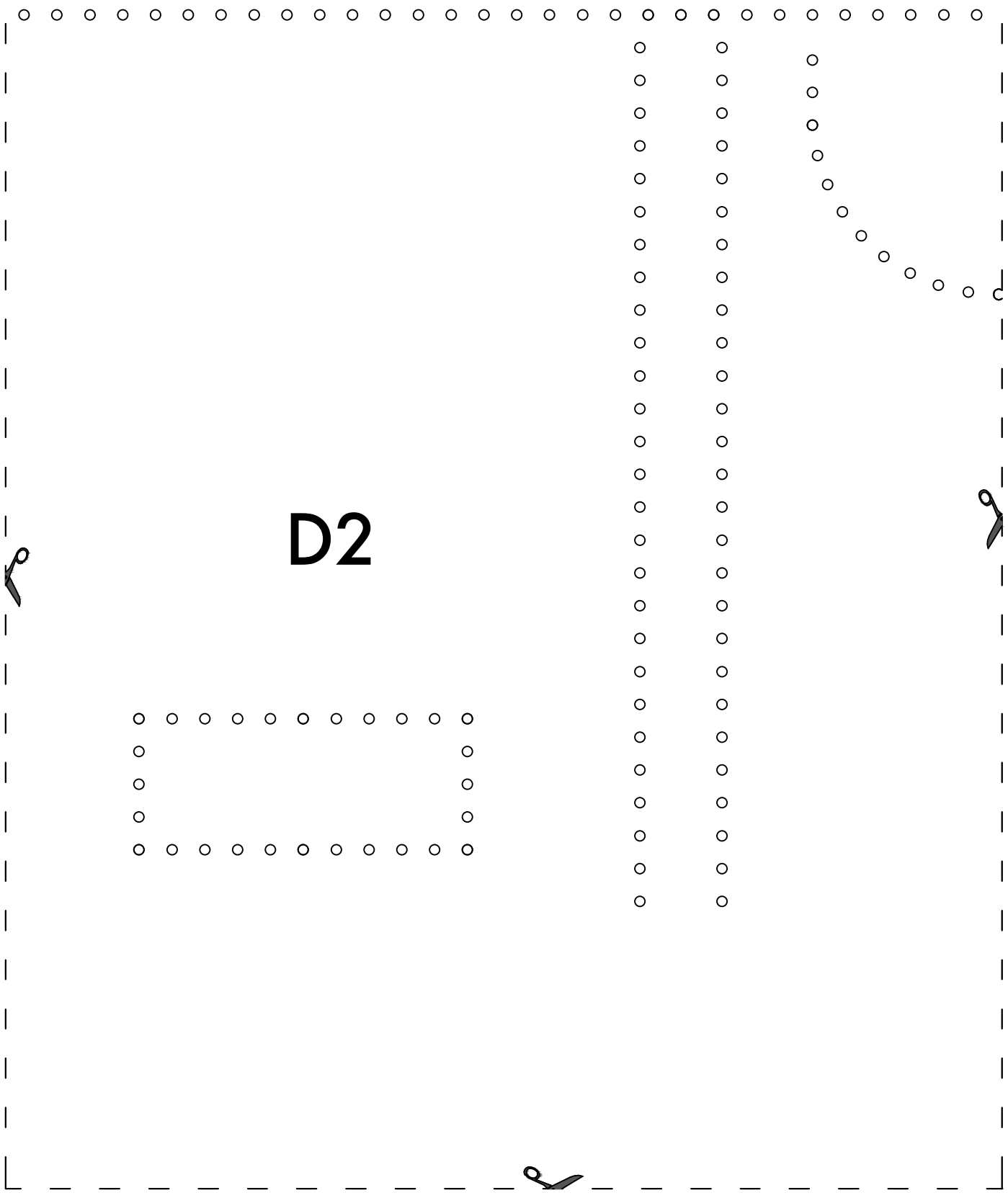

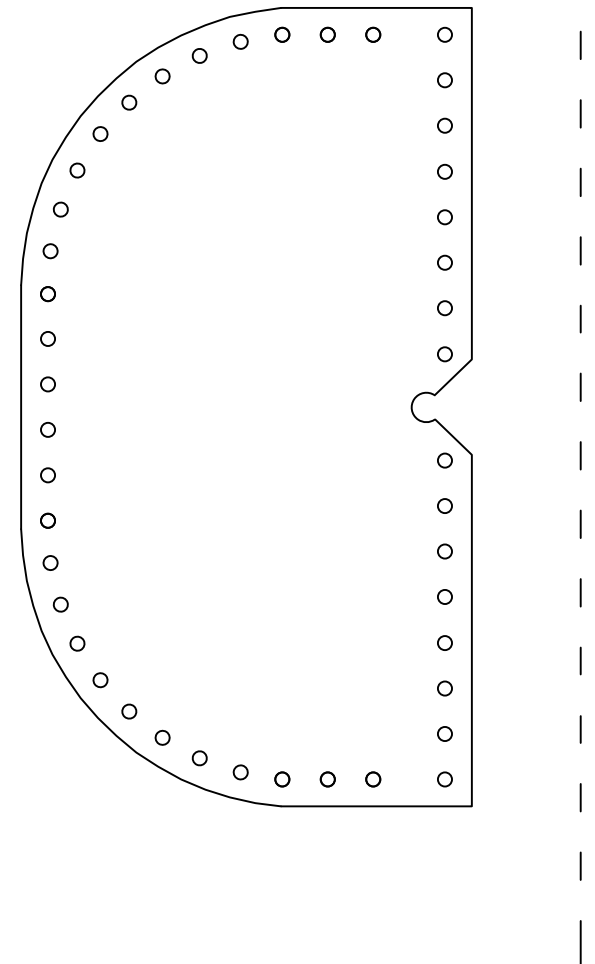
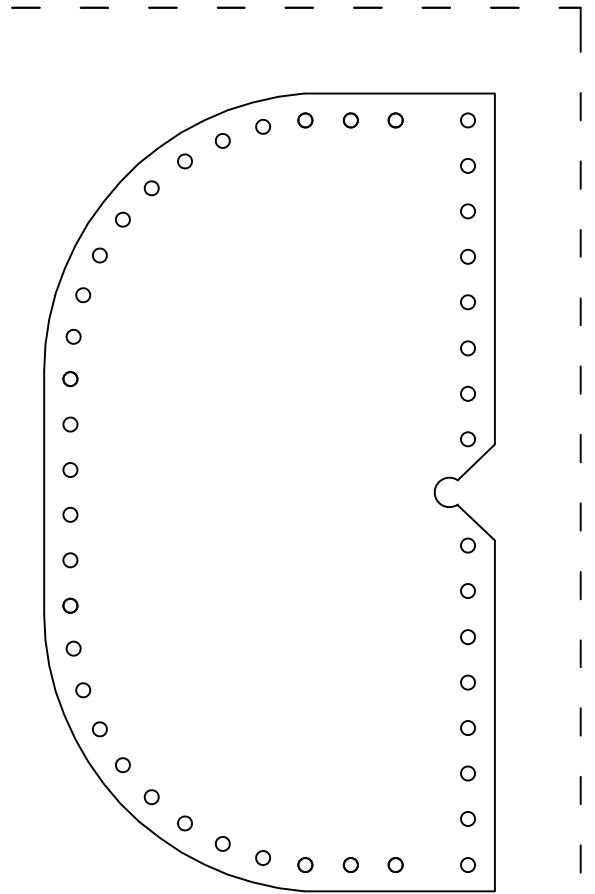
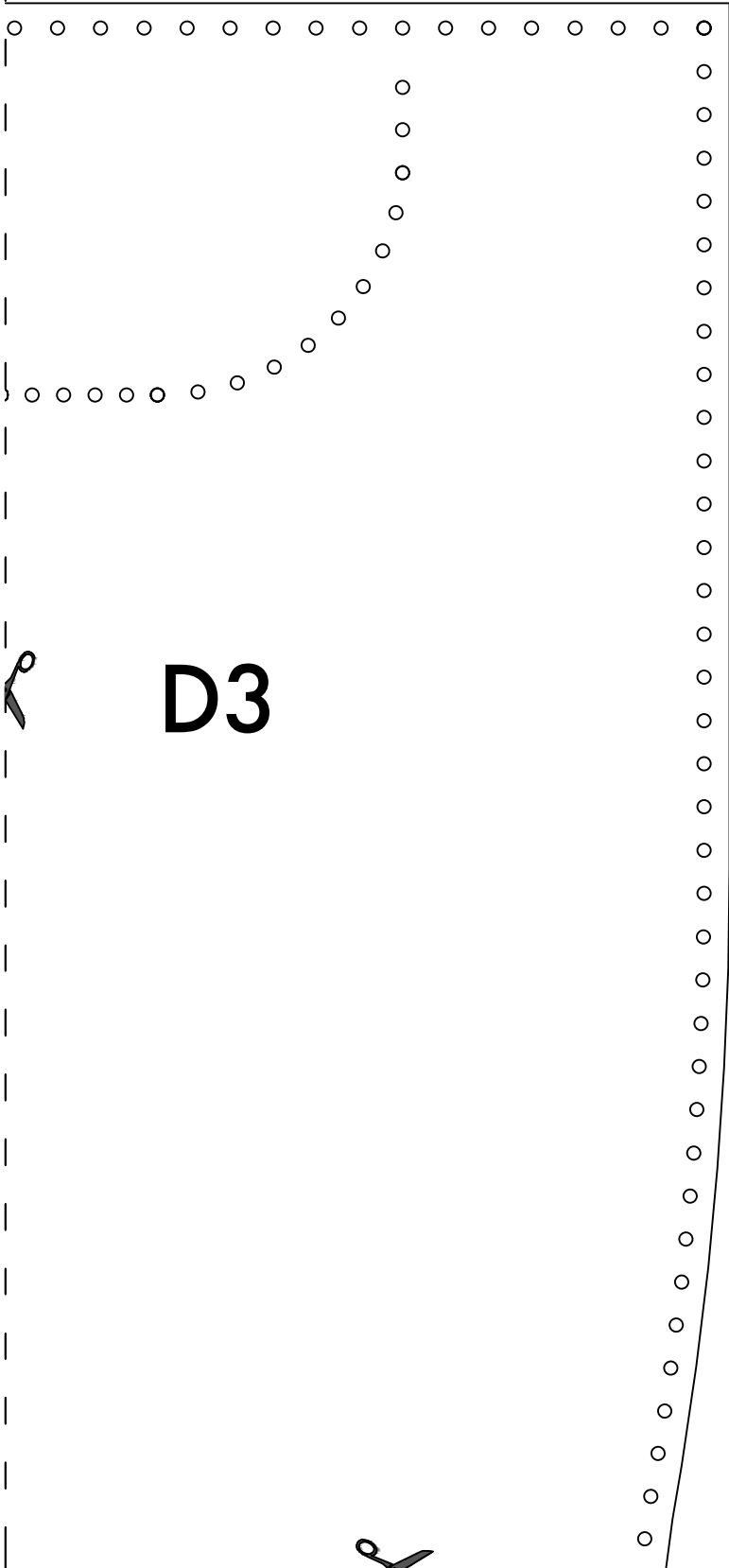
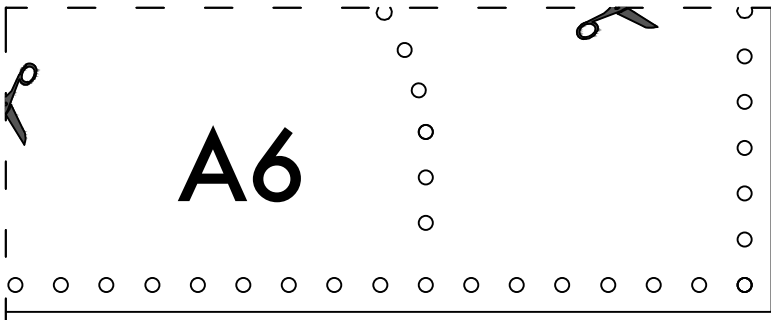

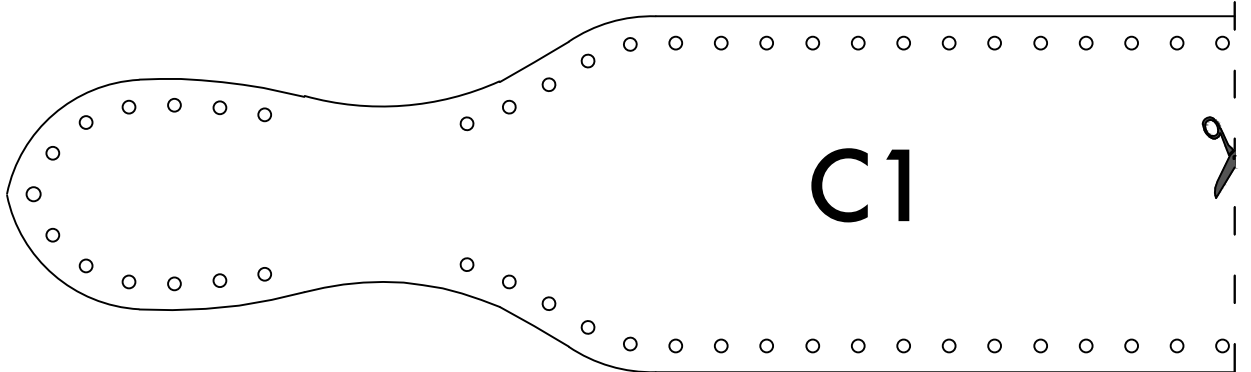
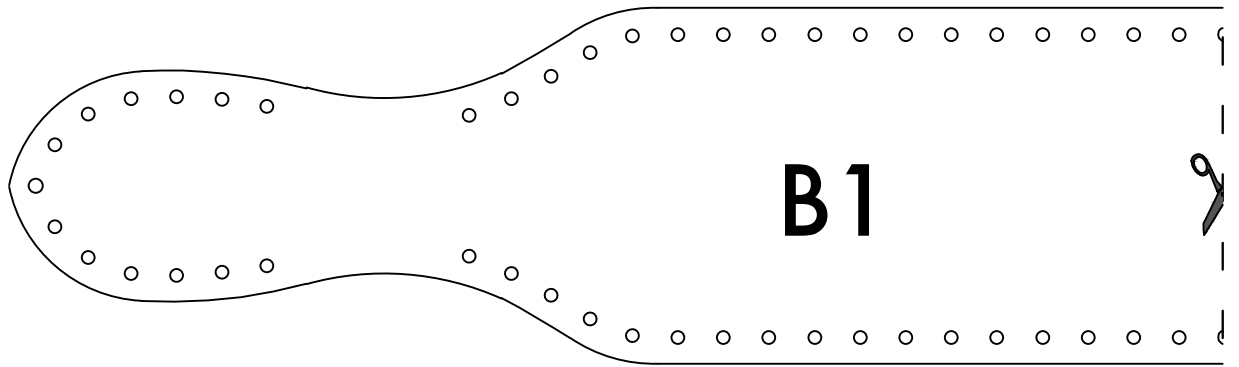
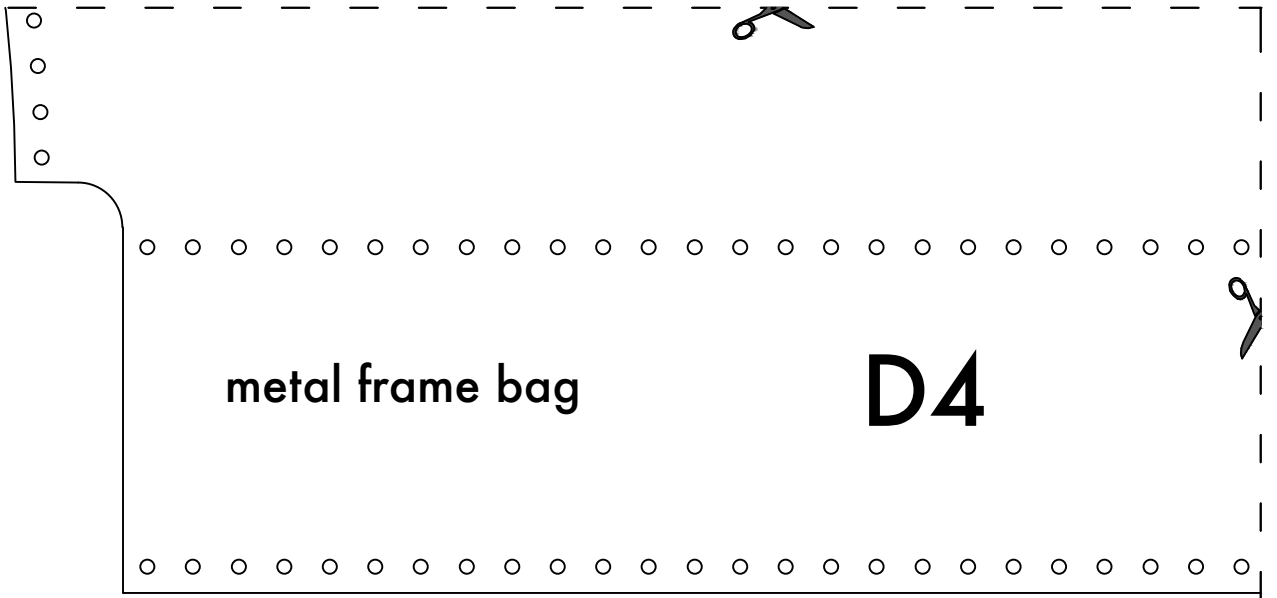



D5

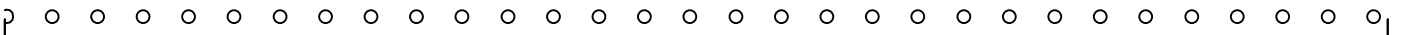
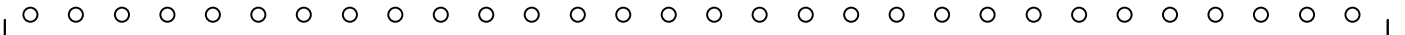

B2

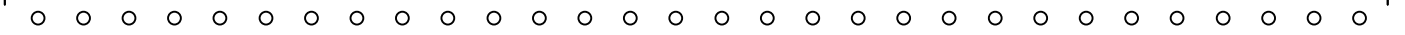
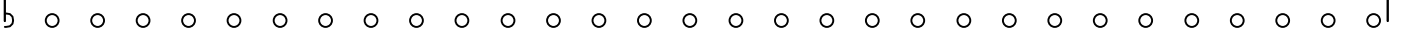

C2

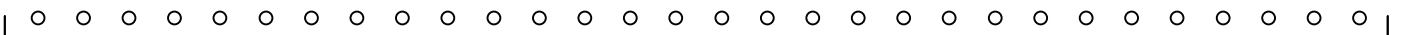

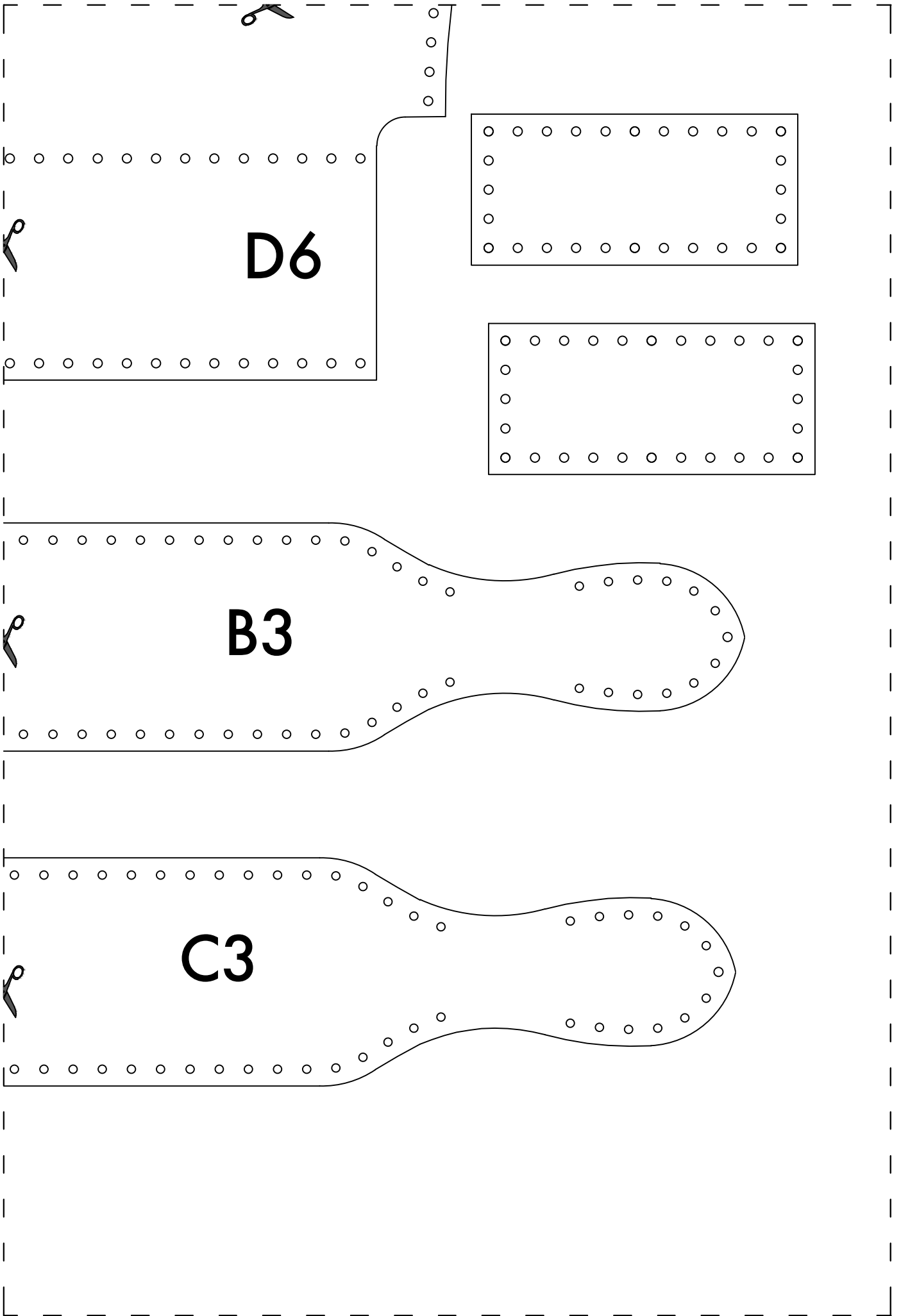

D6

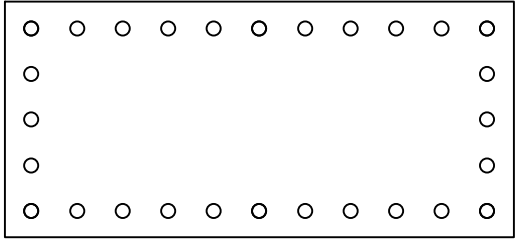
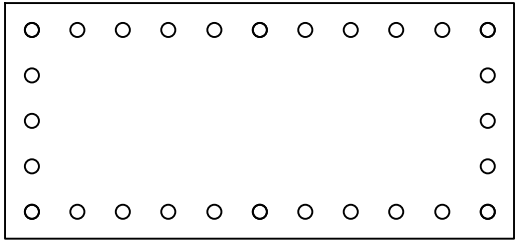

B3

C3

cardboard insert

E1



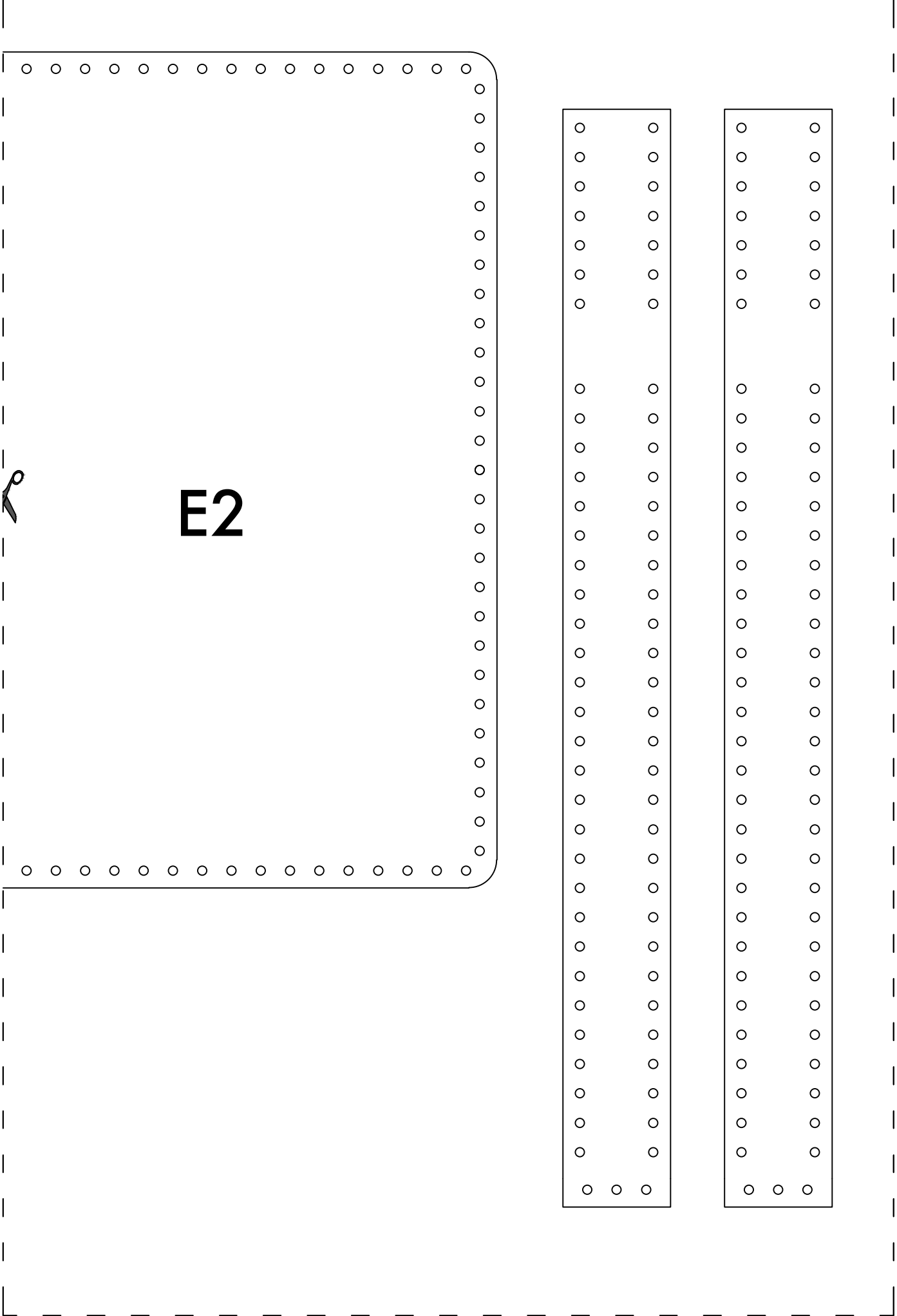

E2

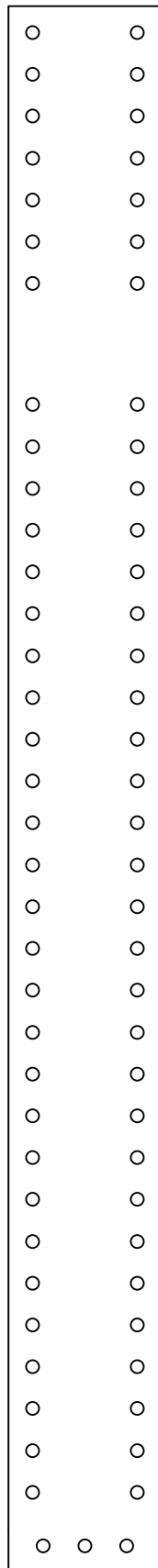
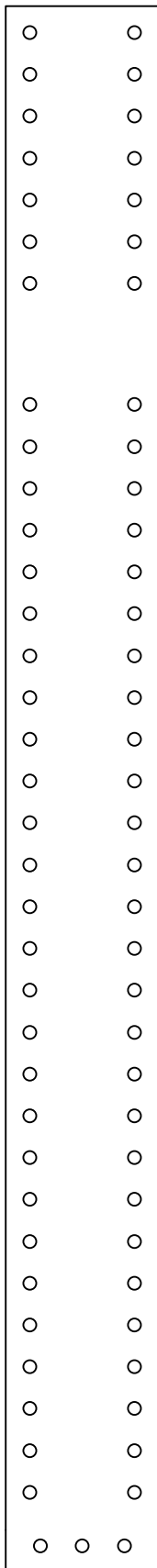

F1



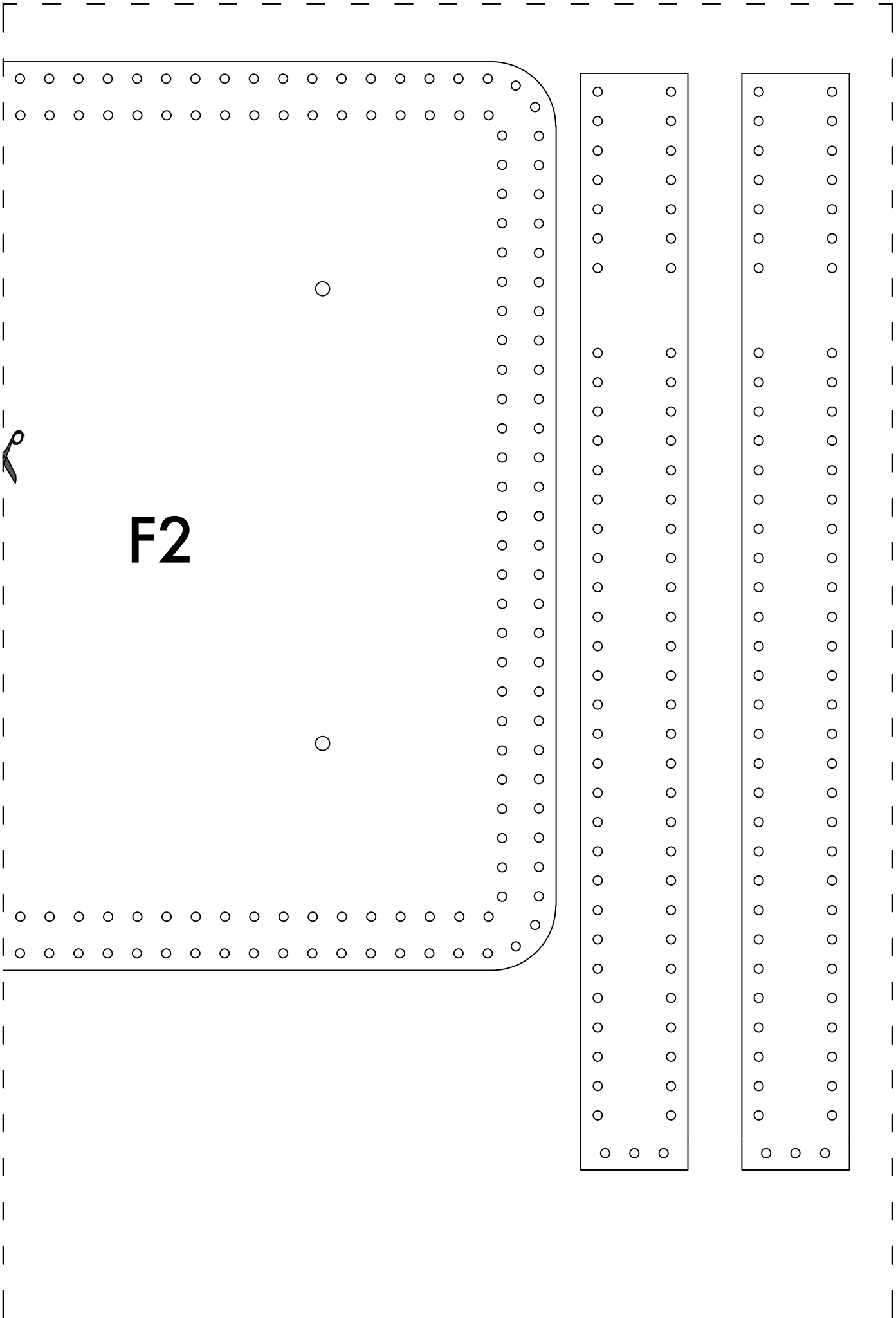

F2



The "Doktor" zipper design



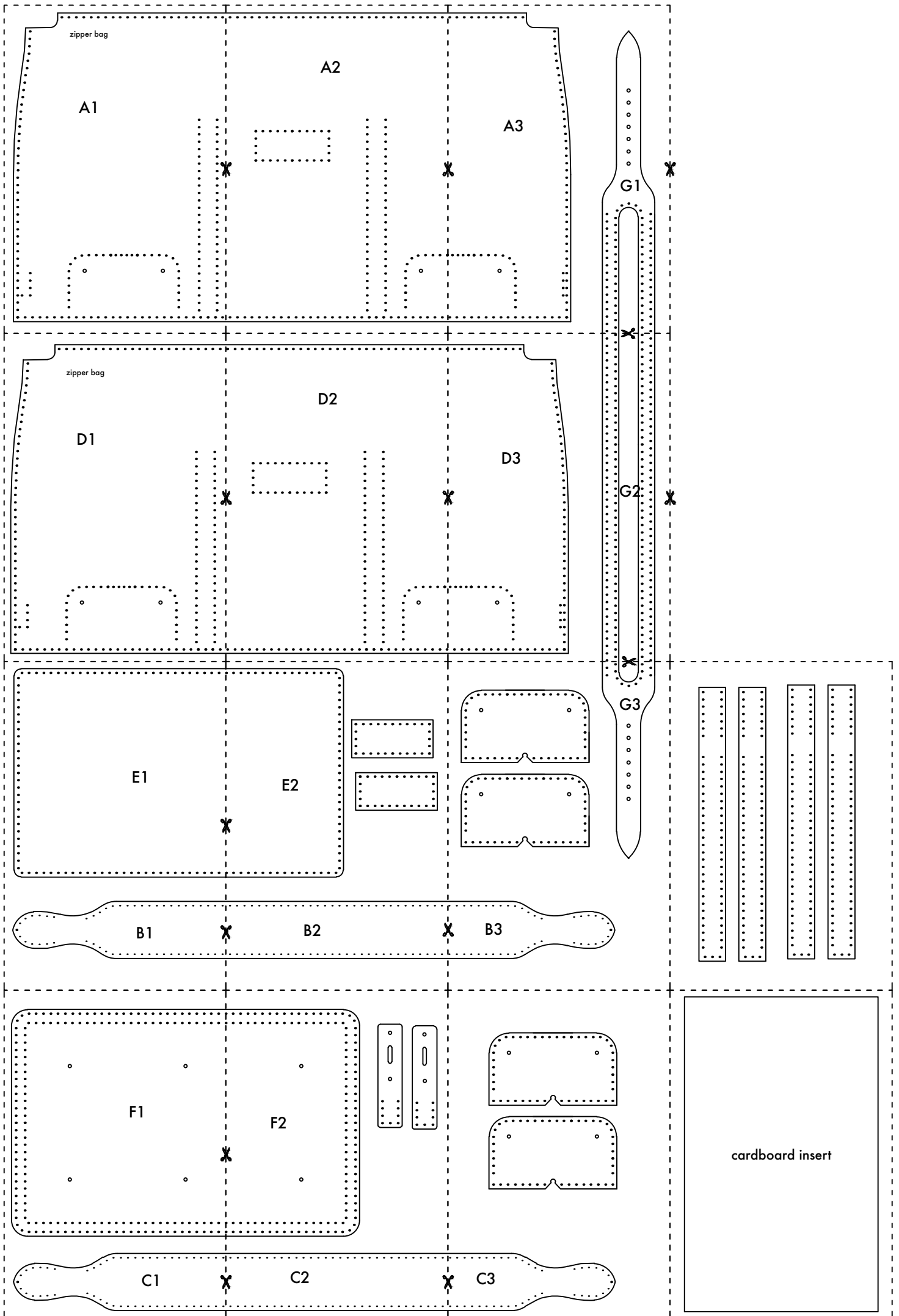

zipper bag

A1



A2

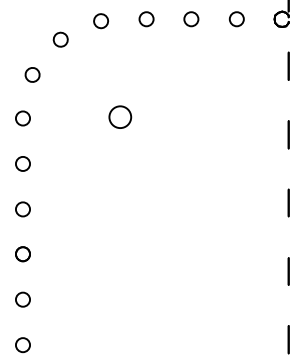
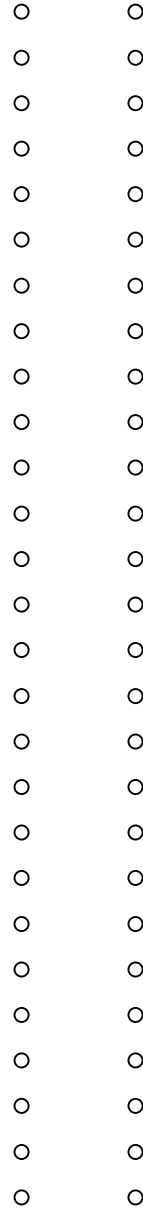
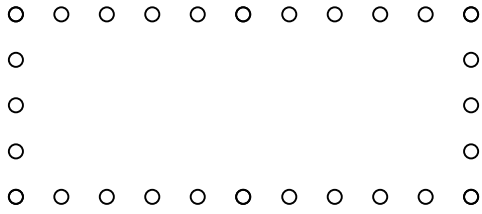

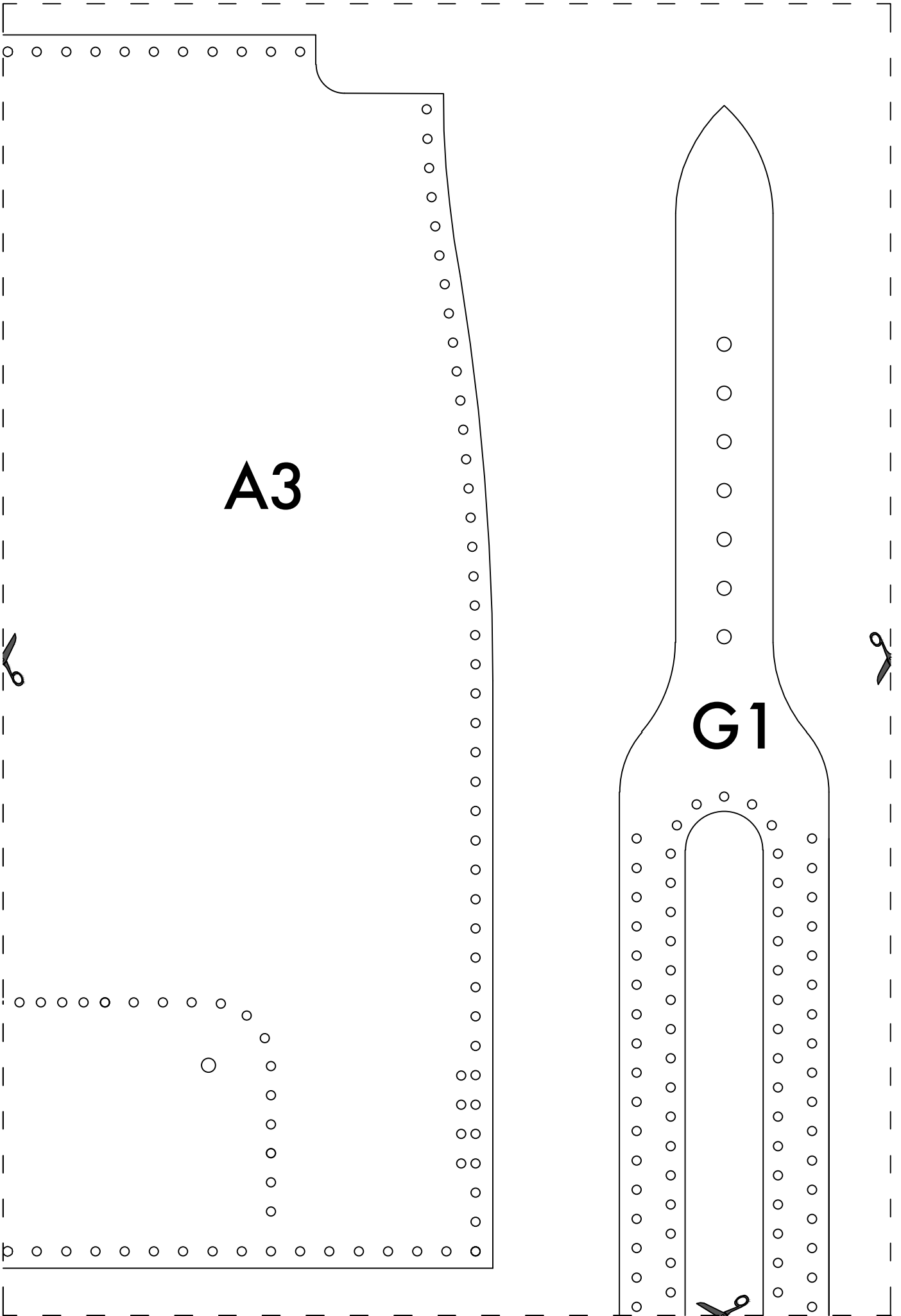

A3

G1

zipper bag

D1



D2

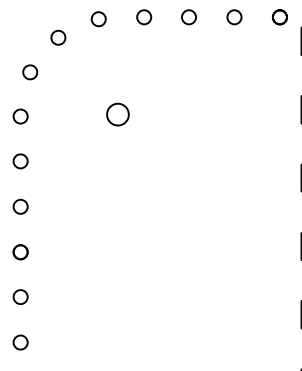
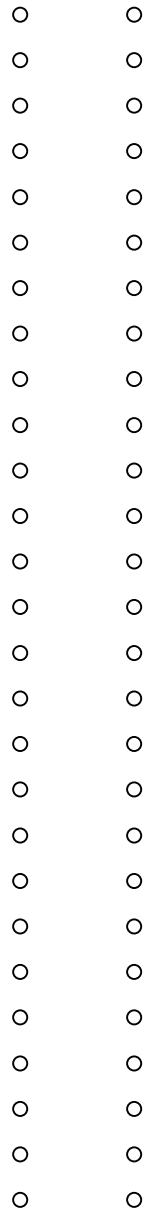
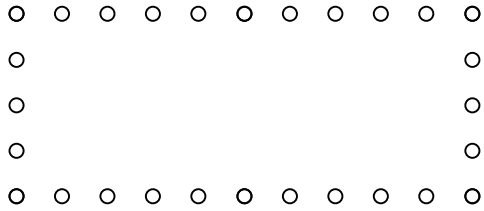

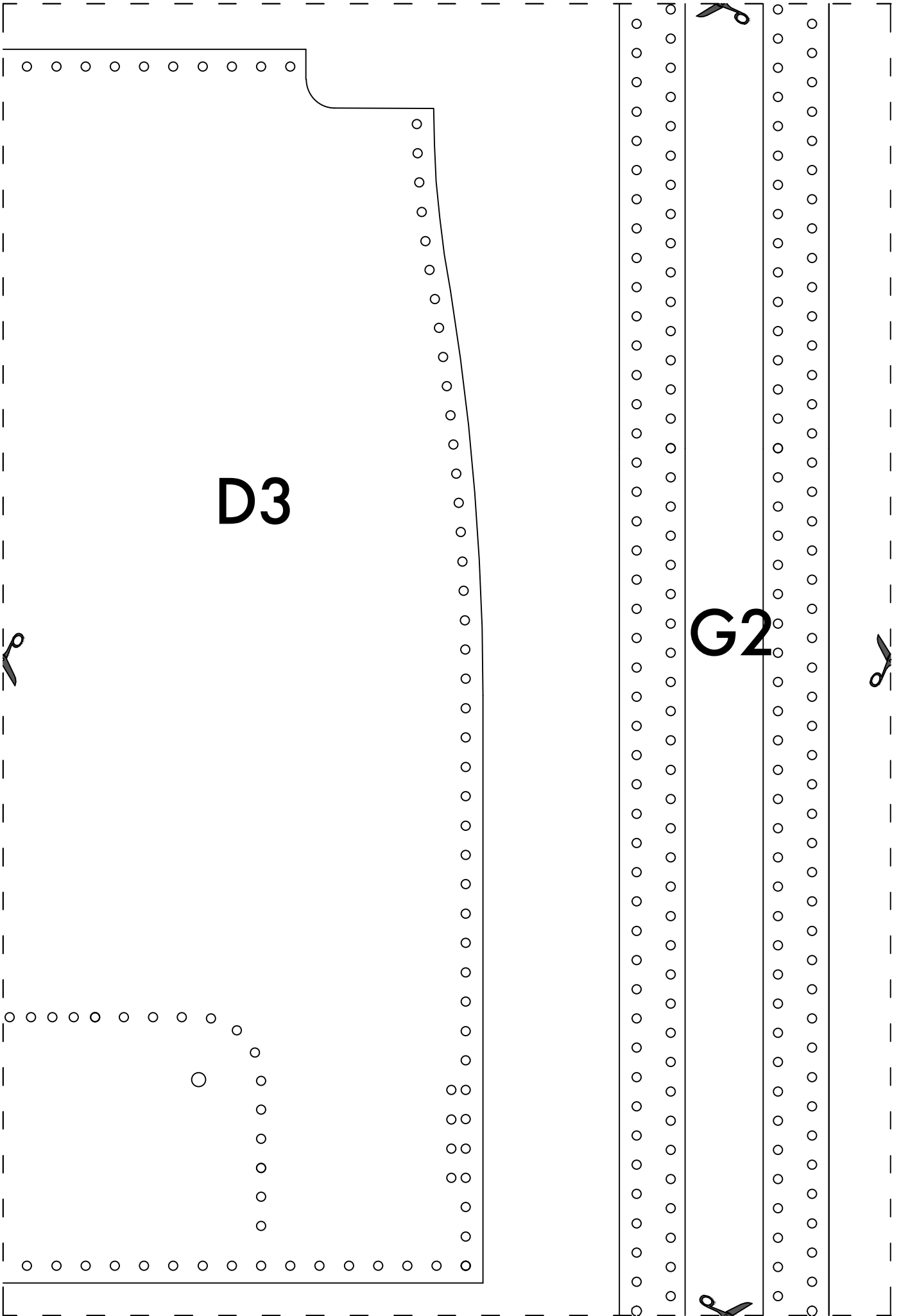

D3

G2

E1



B1



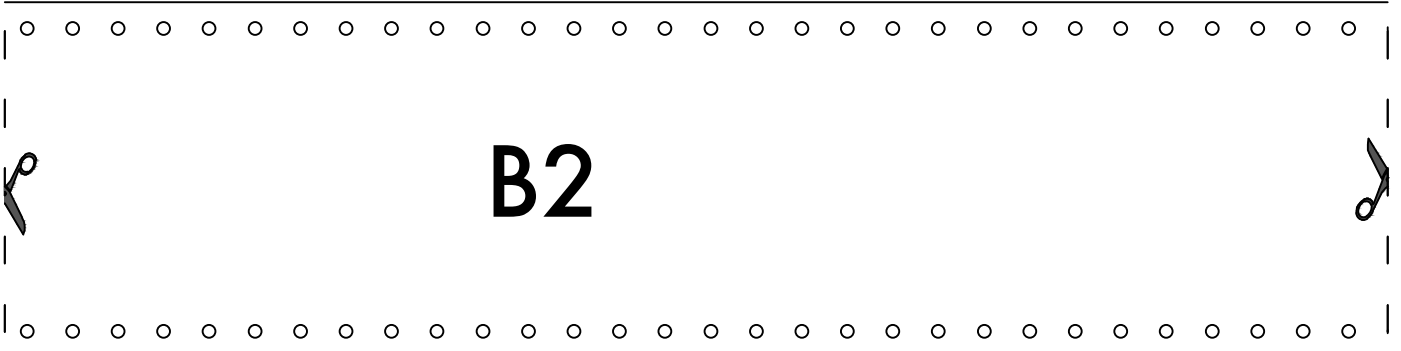
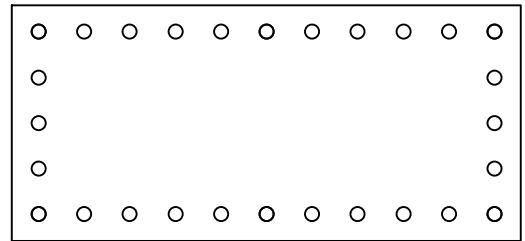
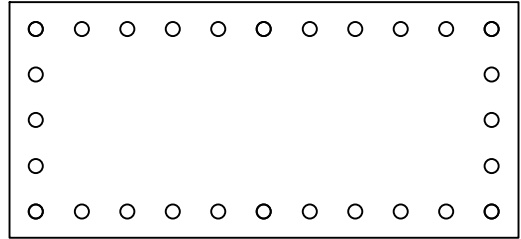
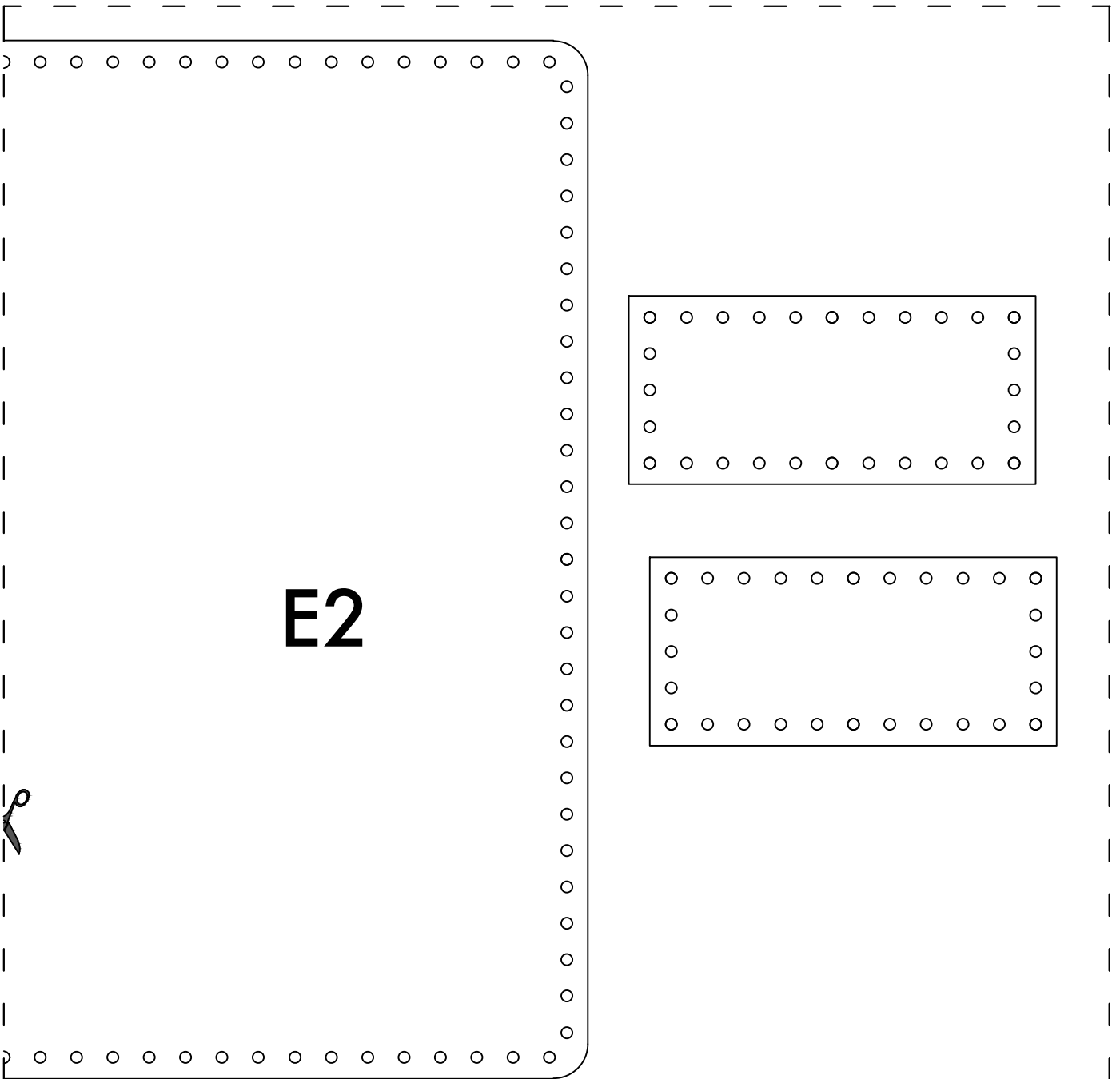

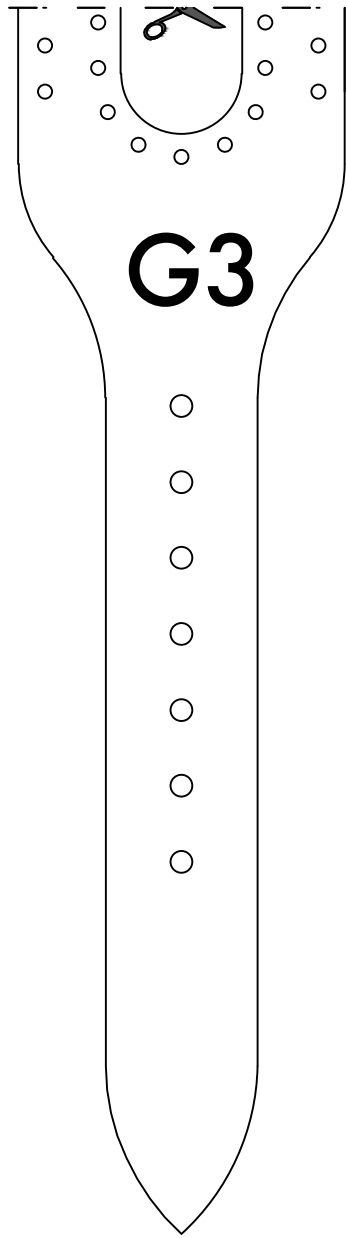
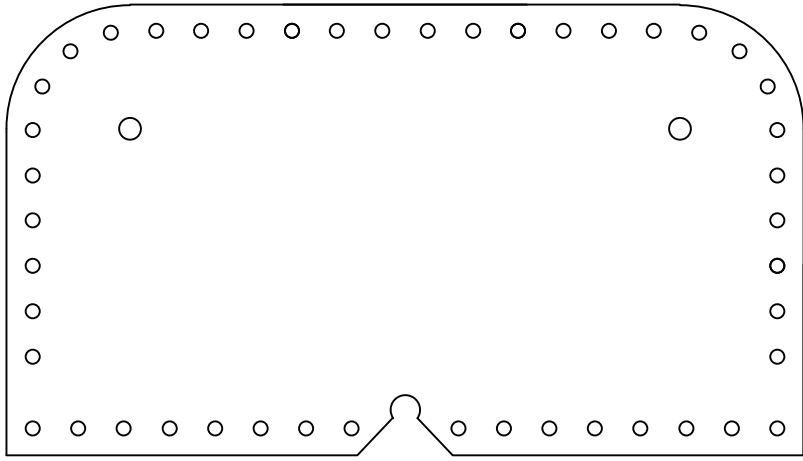
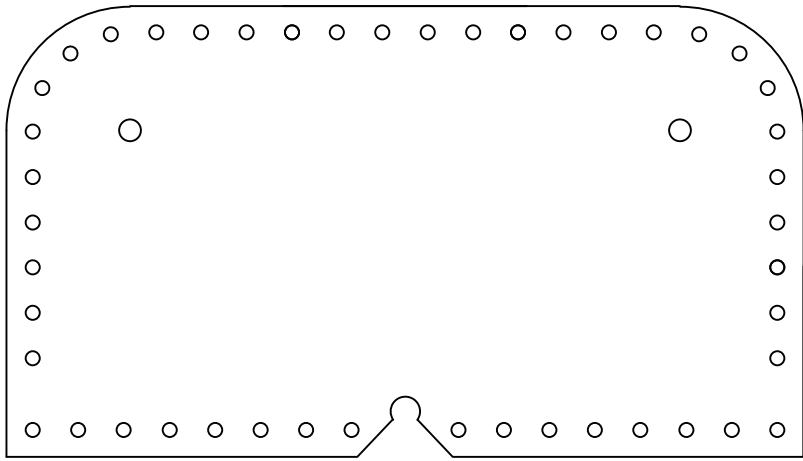

G3

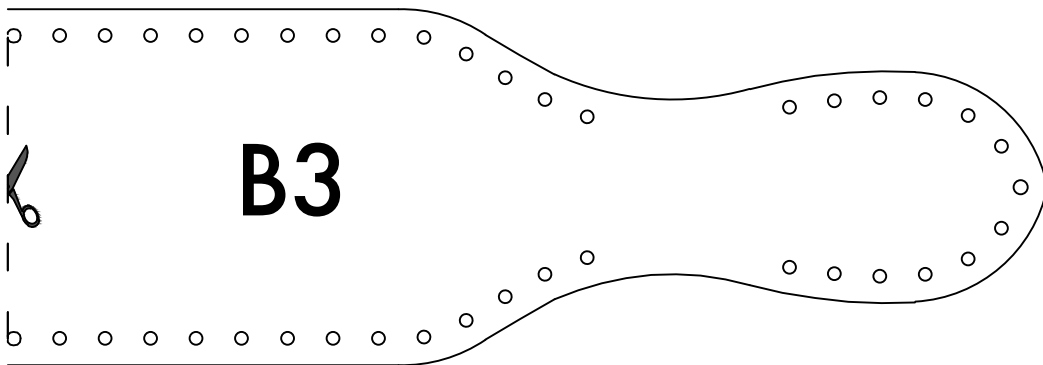

B3

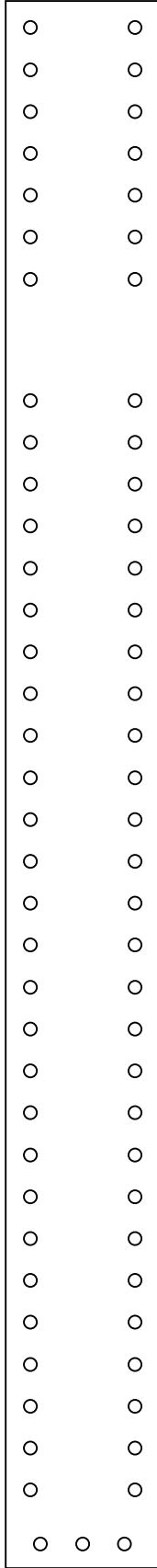
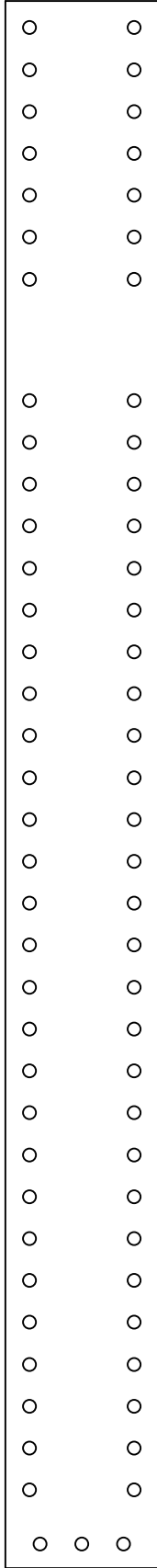
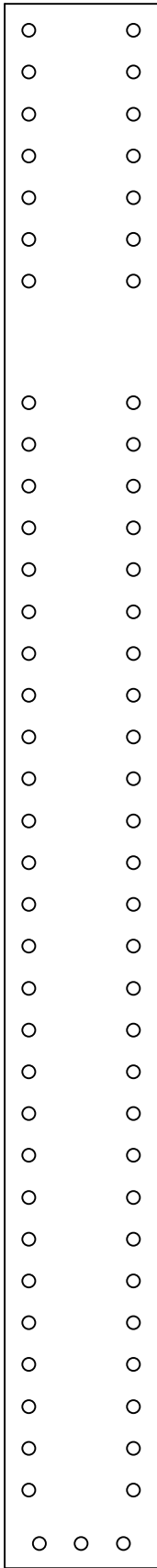
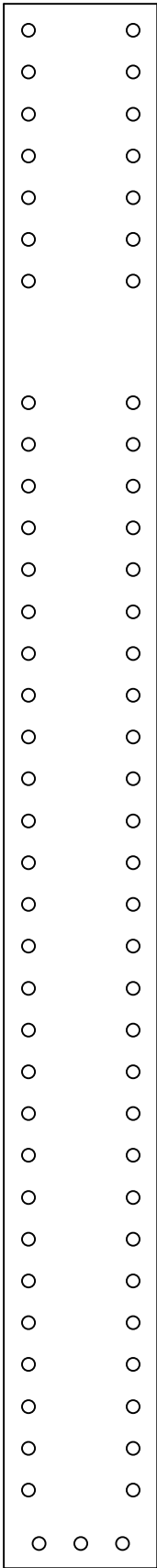

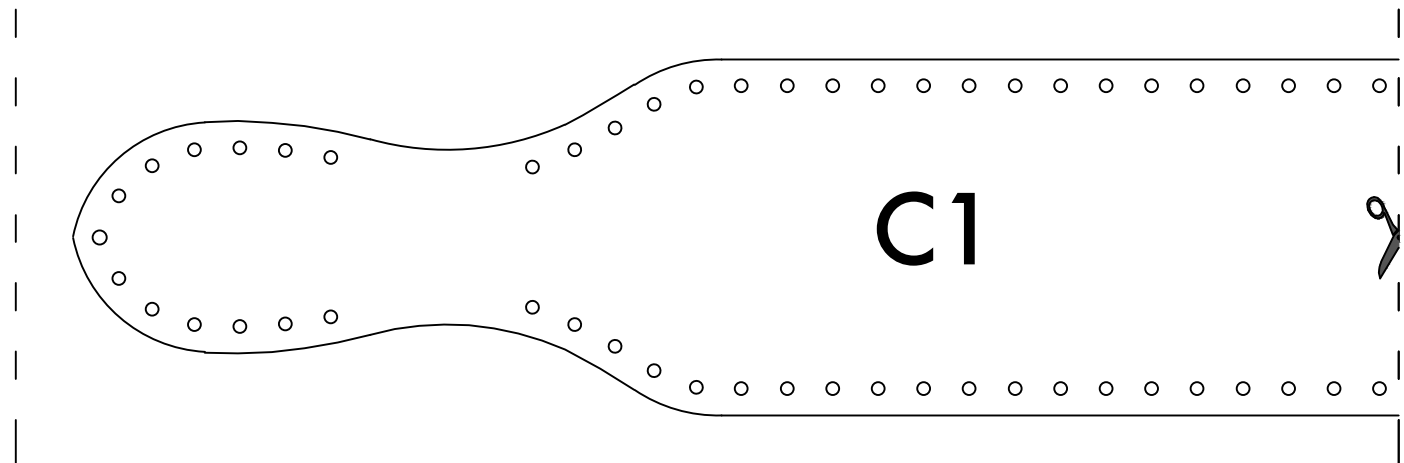
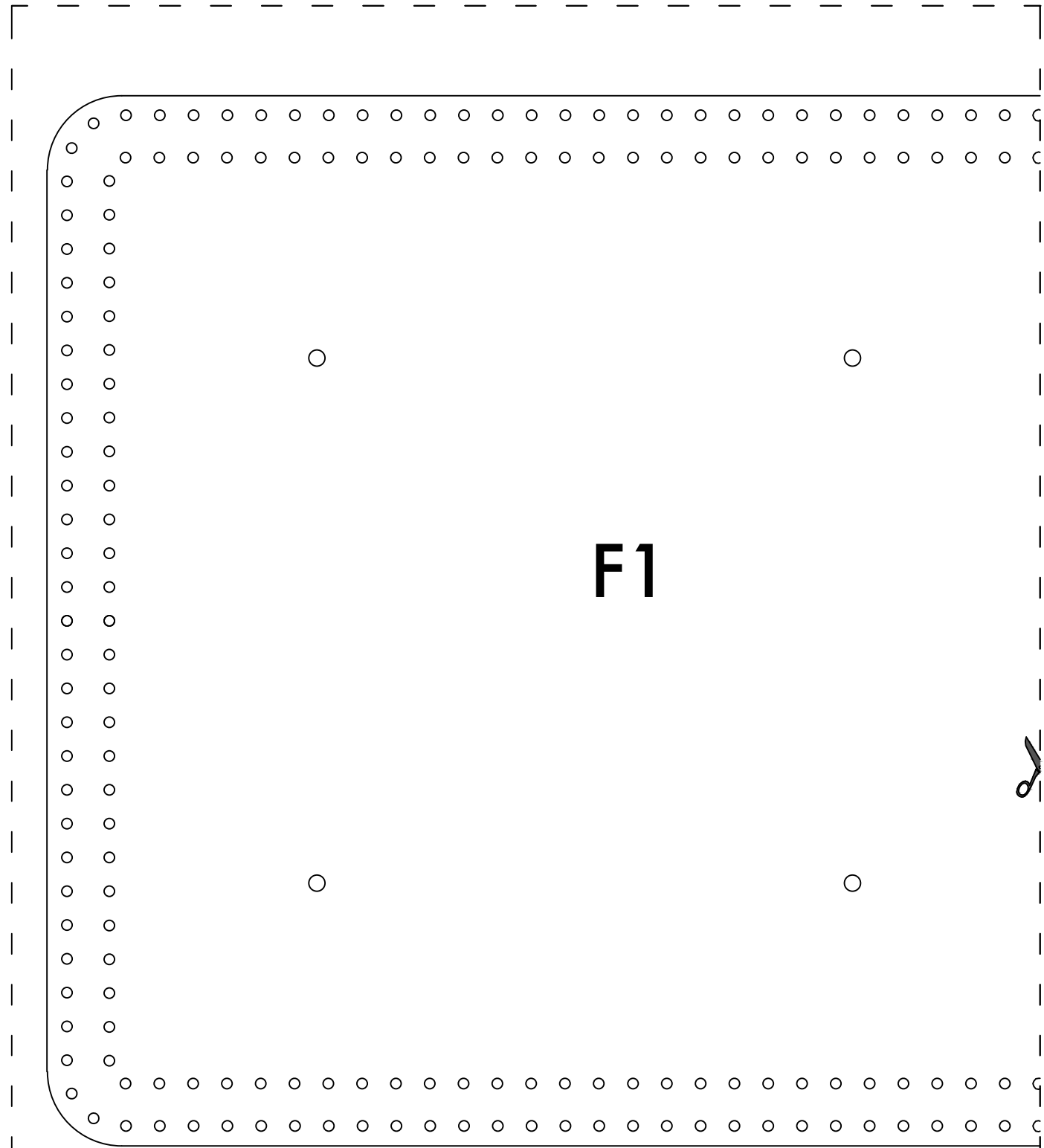

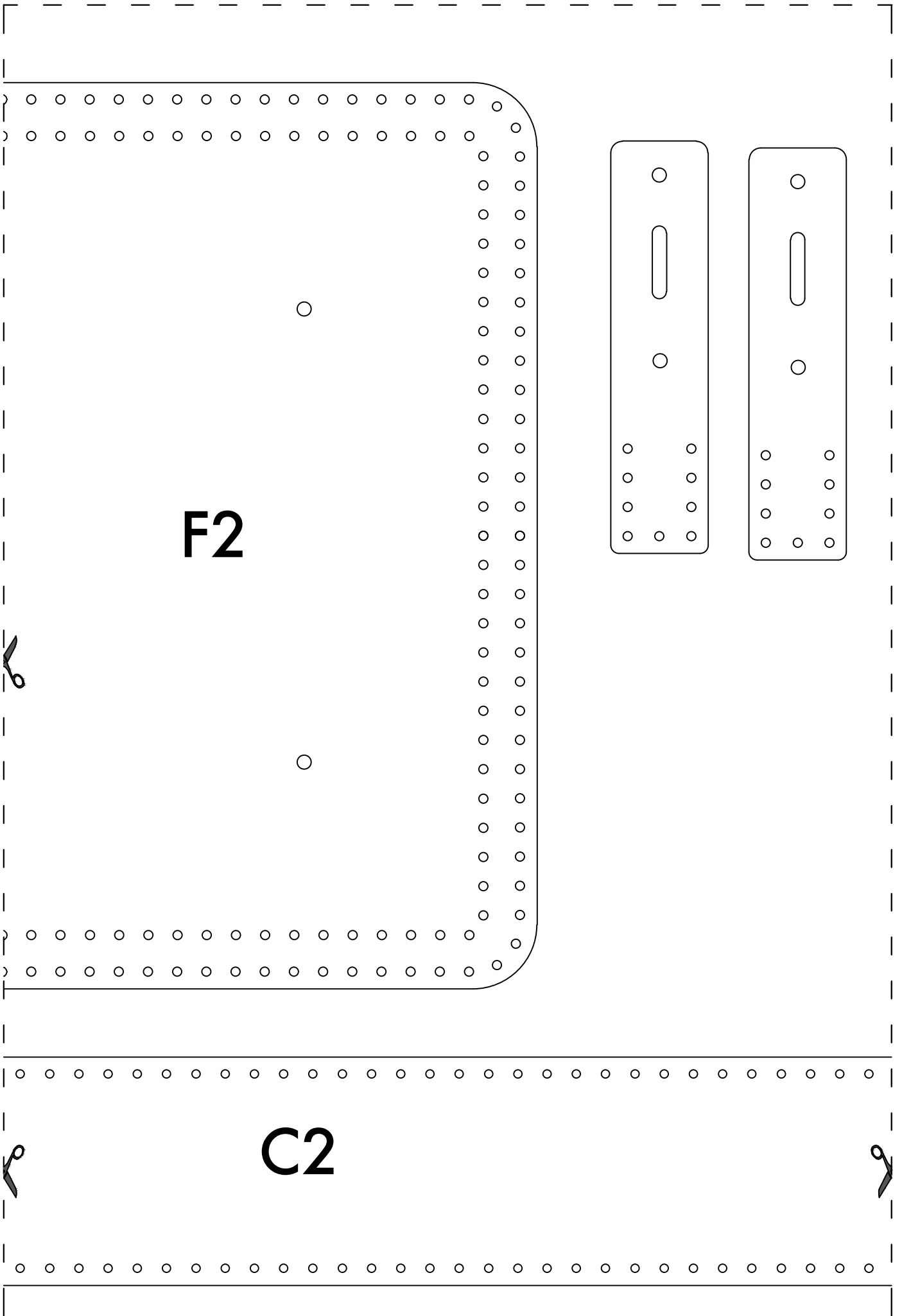

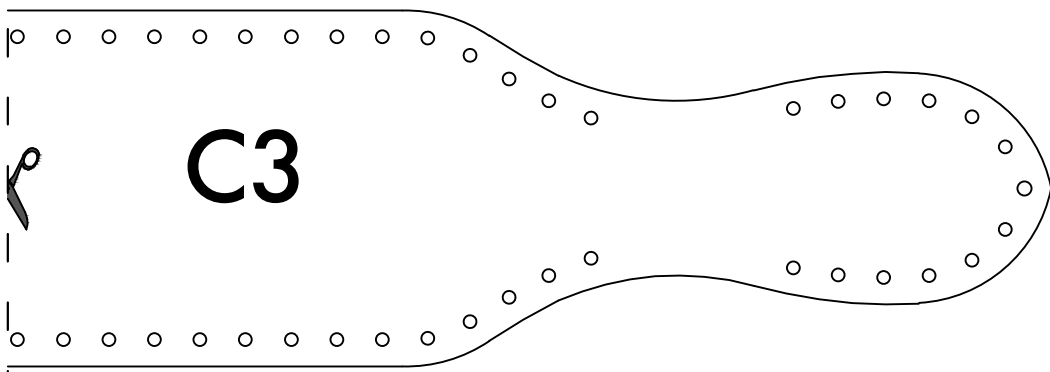
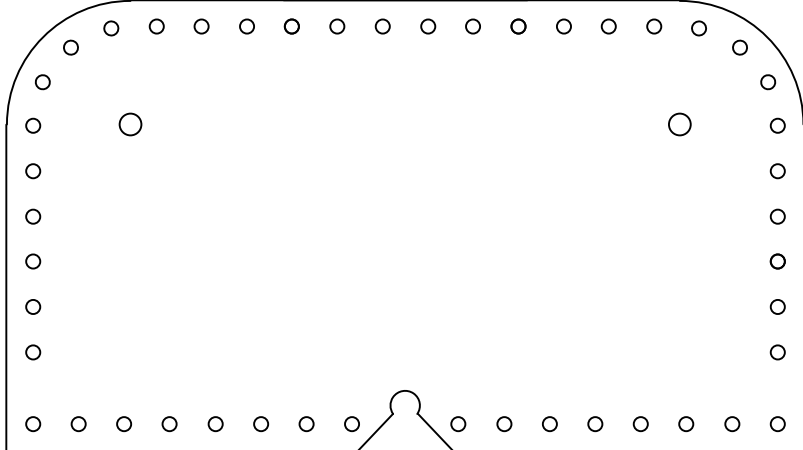
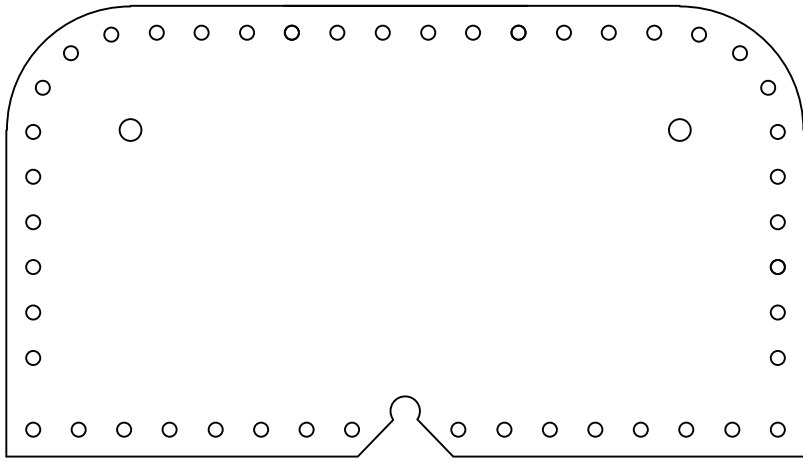

C3

bag divider



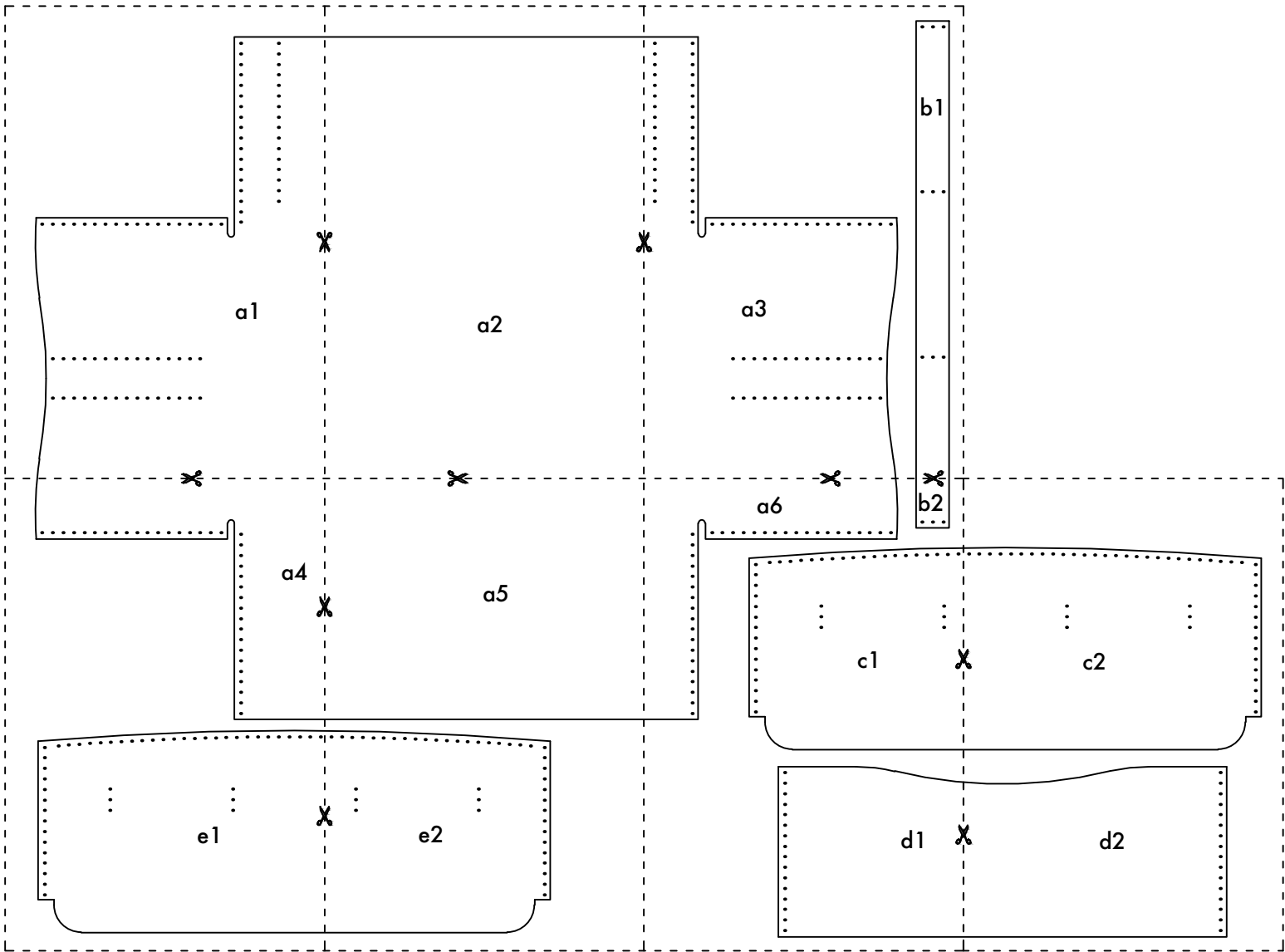

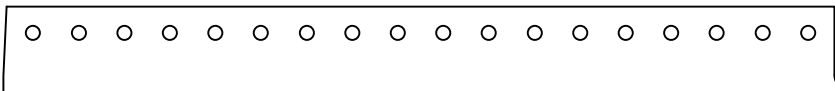
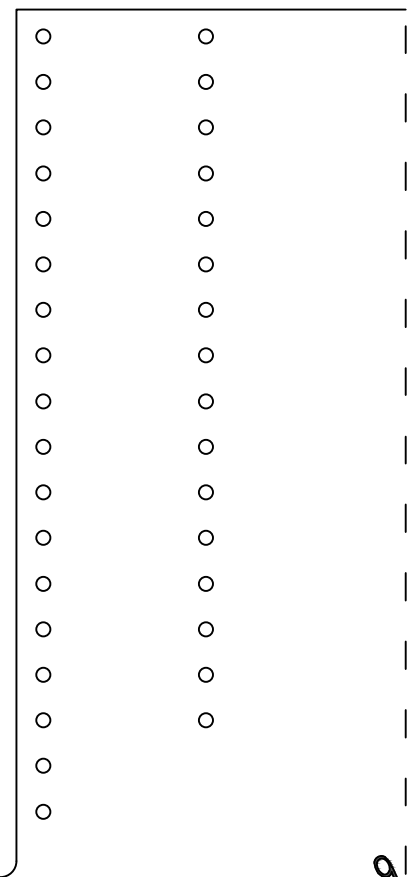
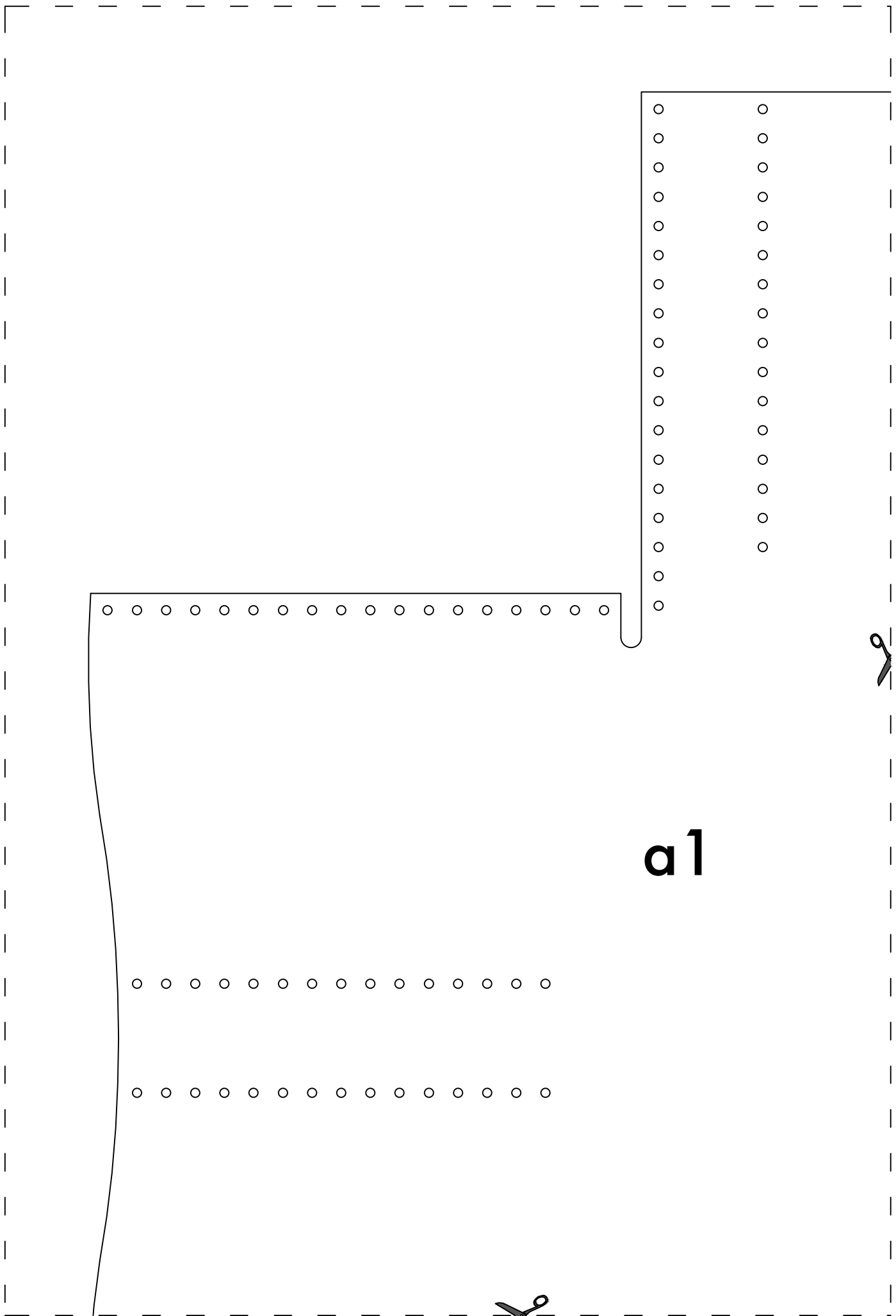

a1



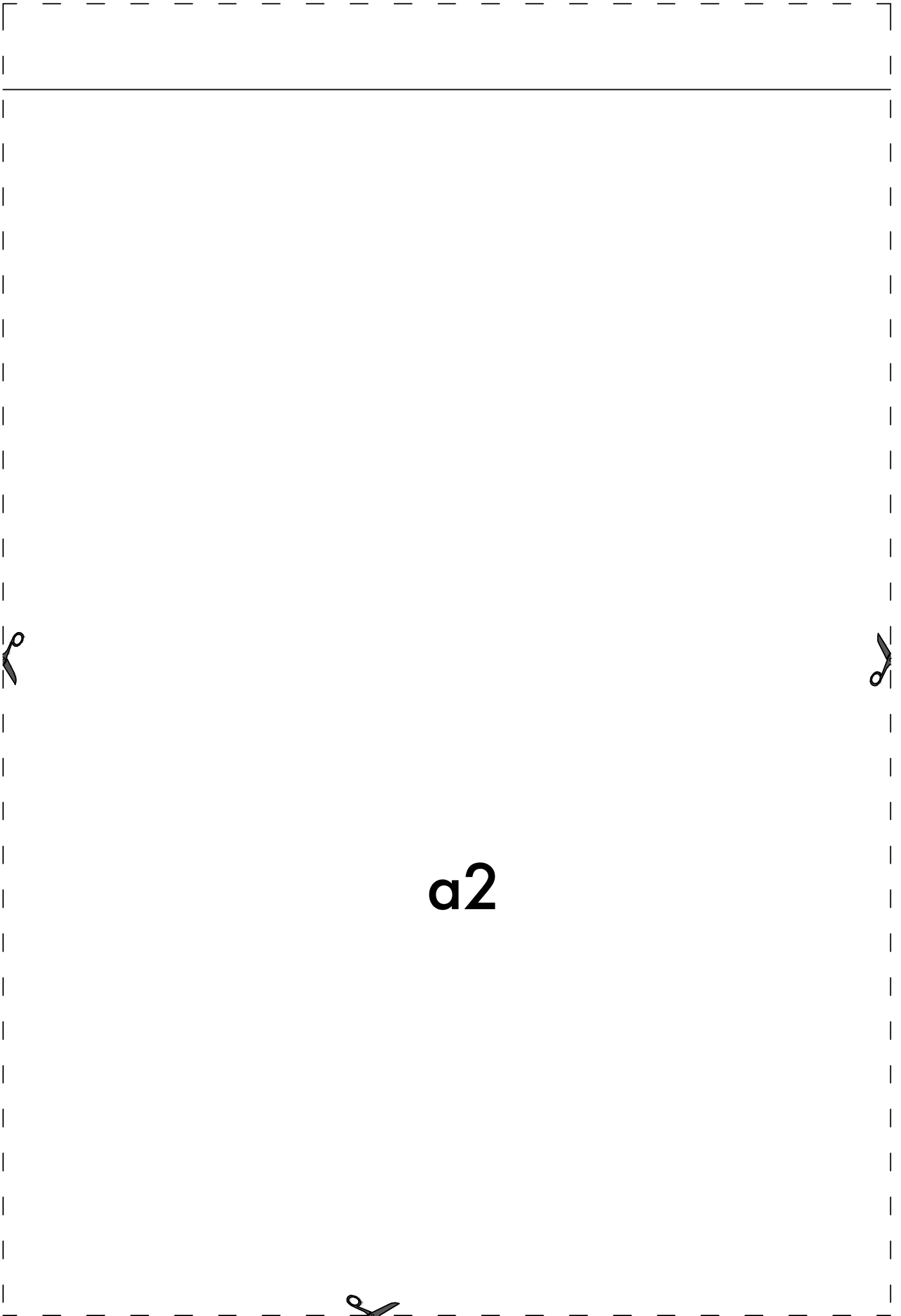

a2



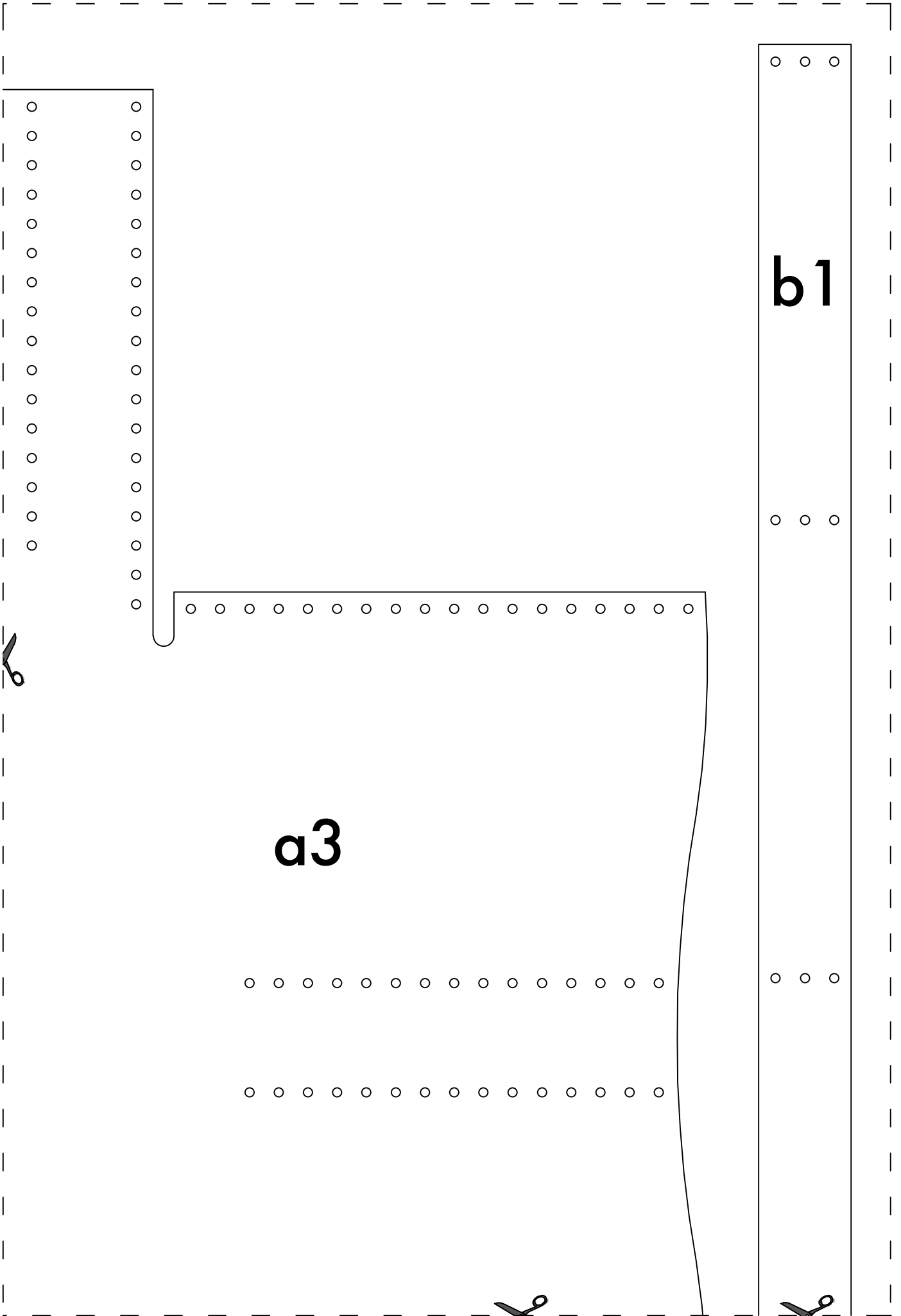

b1

a3

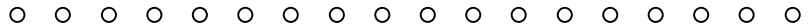
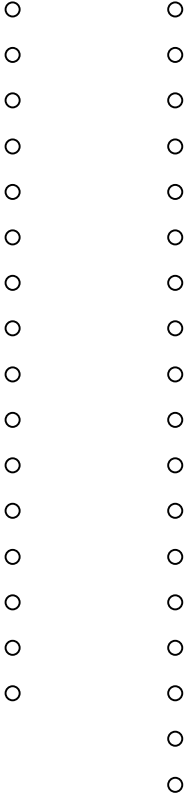

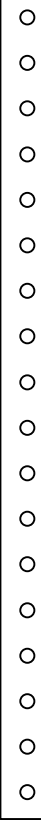
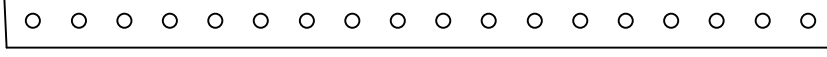

a4

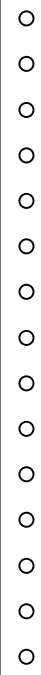
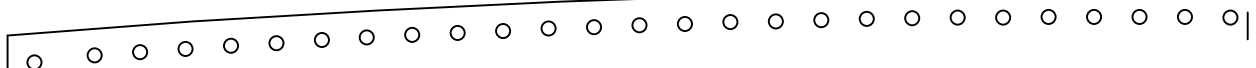

e1





a5

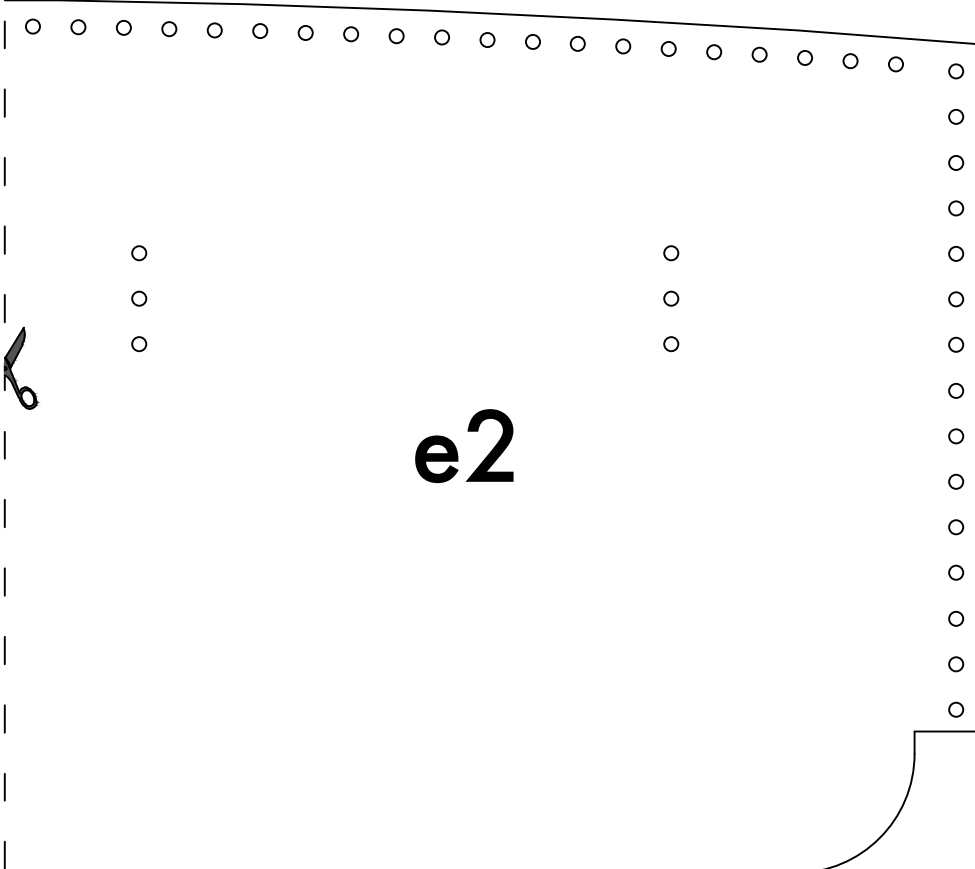

e2



a6

b2

c1

d1

