

Rhombus Bag

©2022 by Eleana Workshop

5cm / 2in.

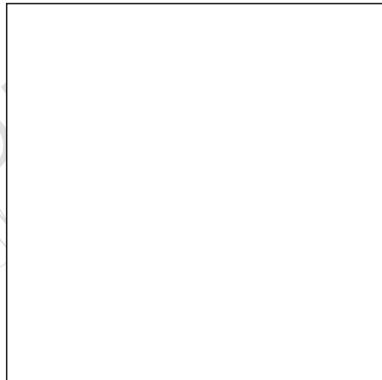

5cm / 2in.

- The pattern is designed for A4 size paper.
Print 1:1, Actual size
- The PDF file contains contains real size patterns and work scheme
- Recommened to use leather in a thickness of 1.8mm
- Pattern comes with 5mm stitch line and 1mm hole punch.
- Thread 0,6 mm

VIDEO TUTORIAL: <https://youtu.be/69qwdUeEivY>



Rhombus Bag

©2022 by Eleana Workshop

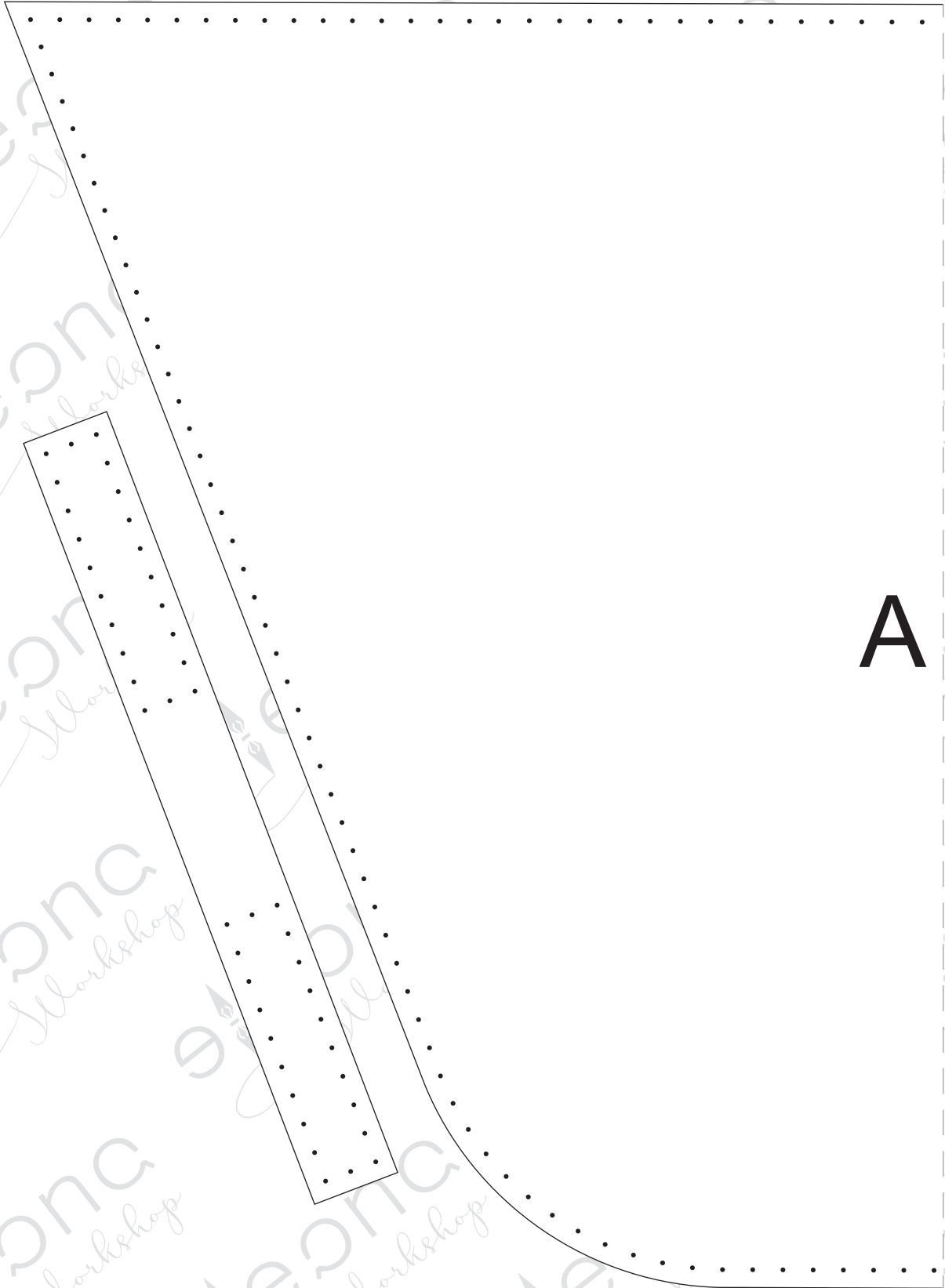

Rhombus Bag

©2022 by Eleana Workshop

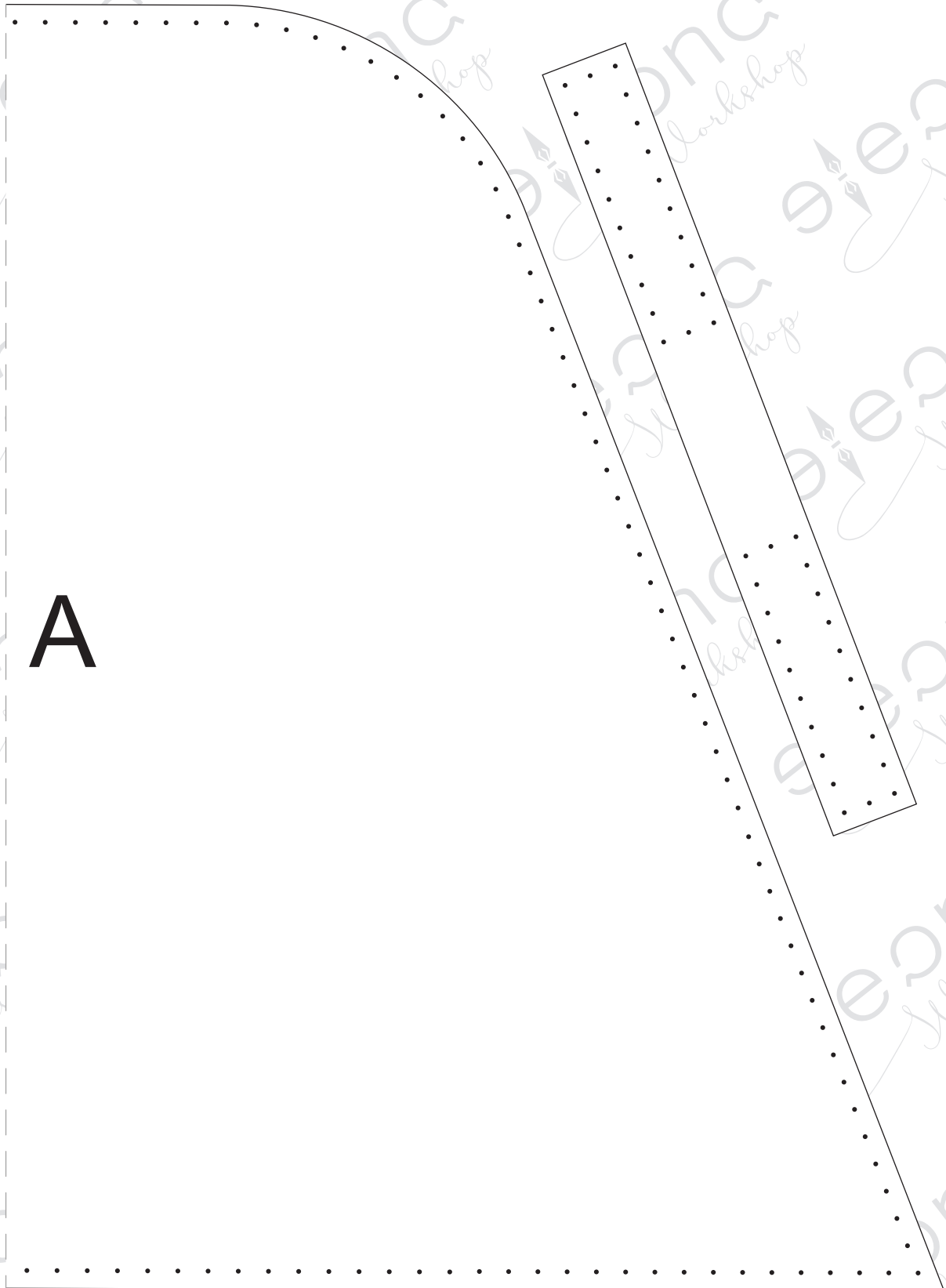

Rhombus Bag

©2022 by Eleana Workshop

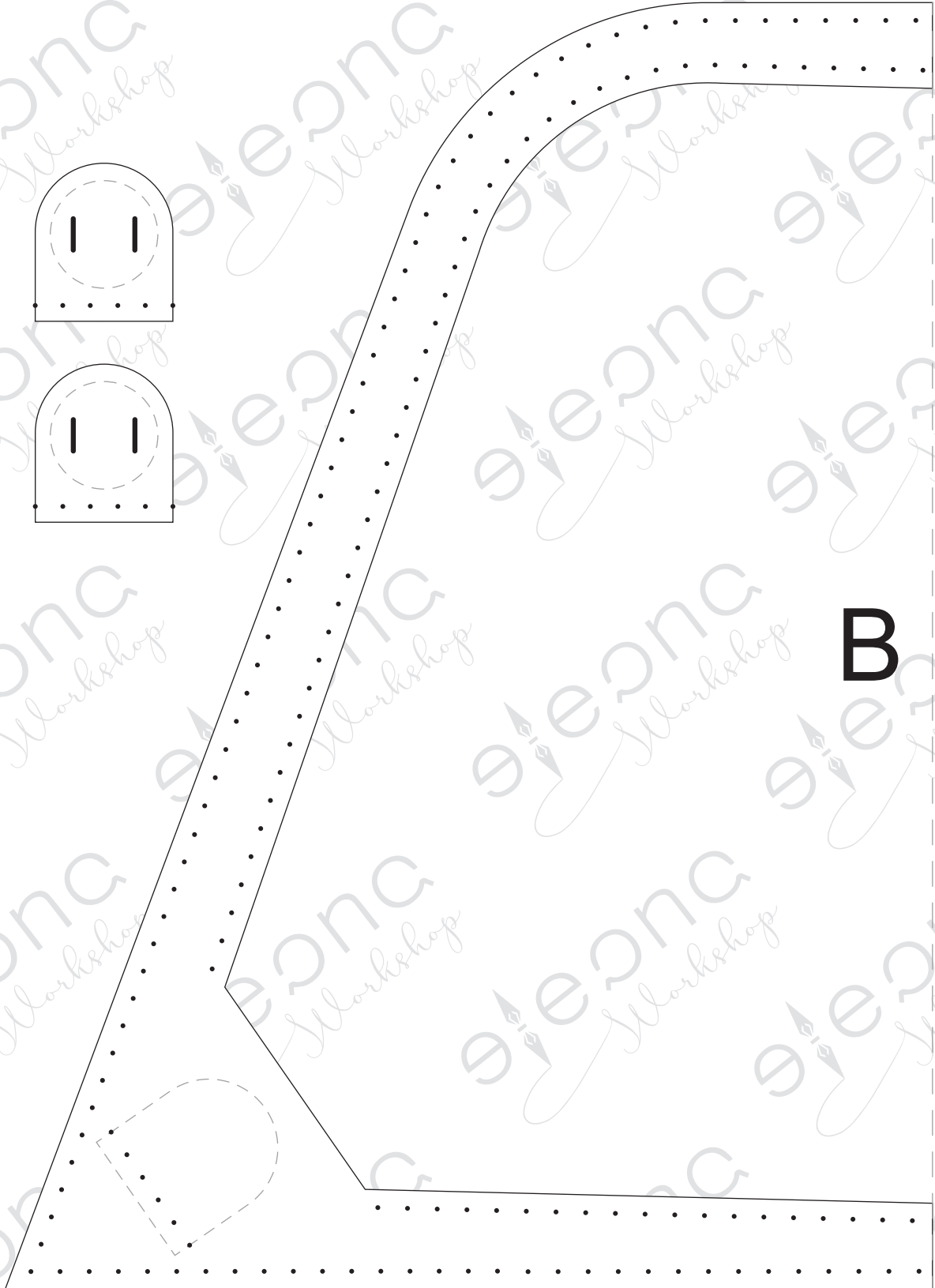
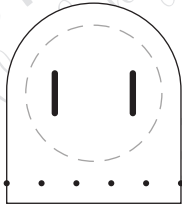
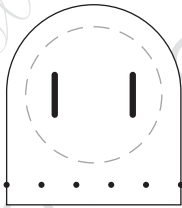

Rhombus Bag

©2022 by Eleana Workshop

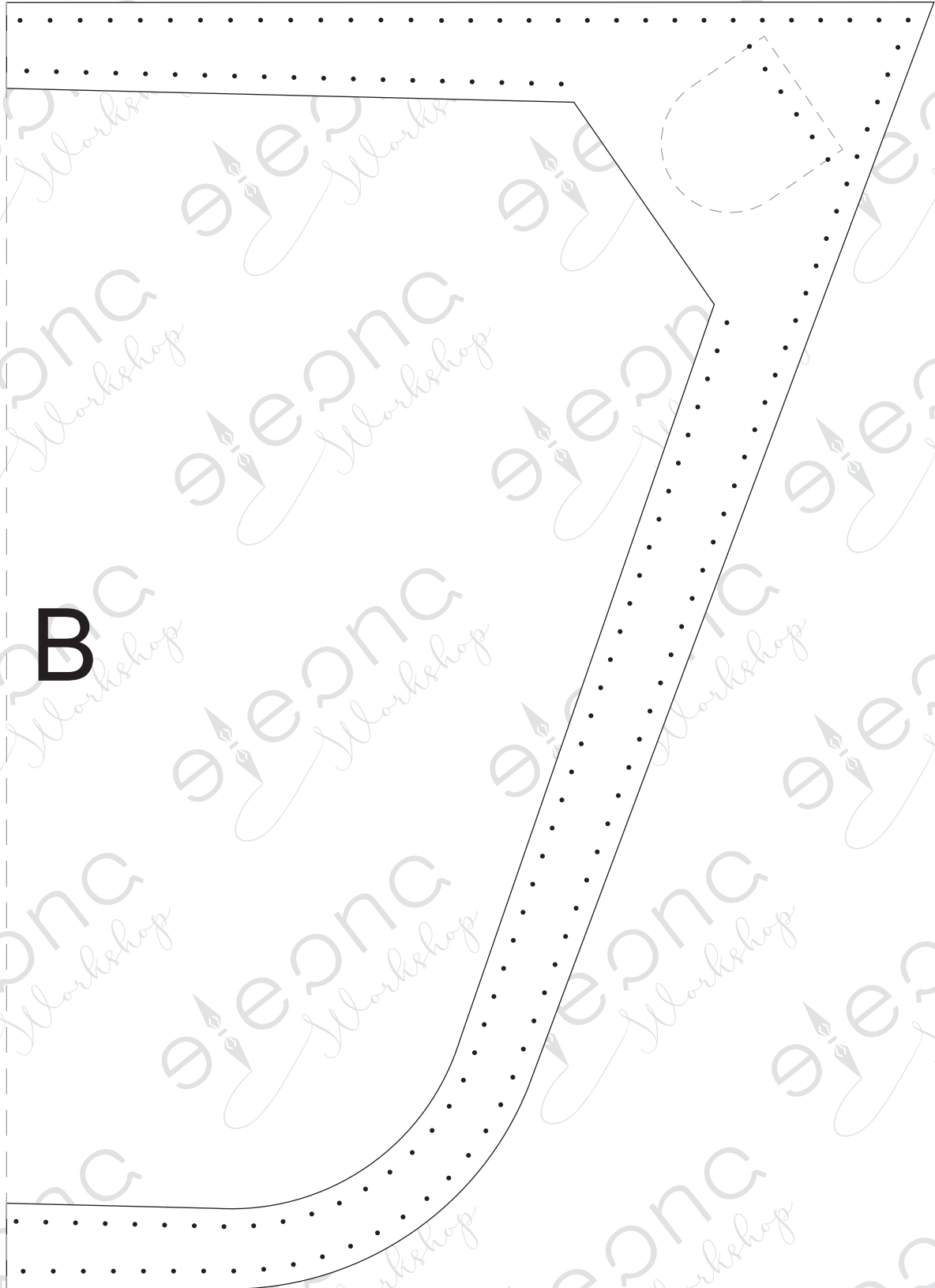

B

Rhombus Bag

©2022 by Eleana Workshop

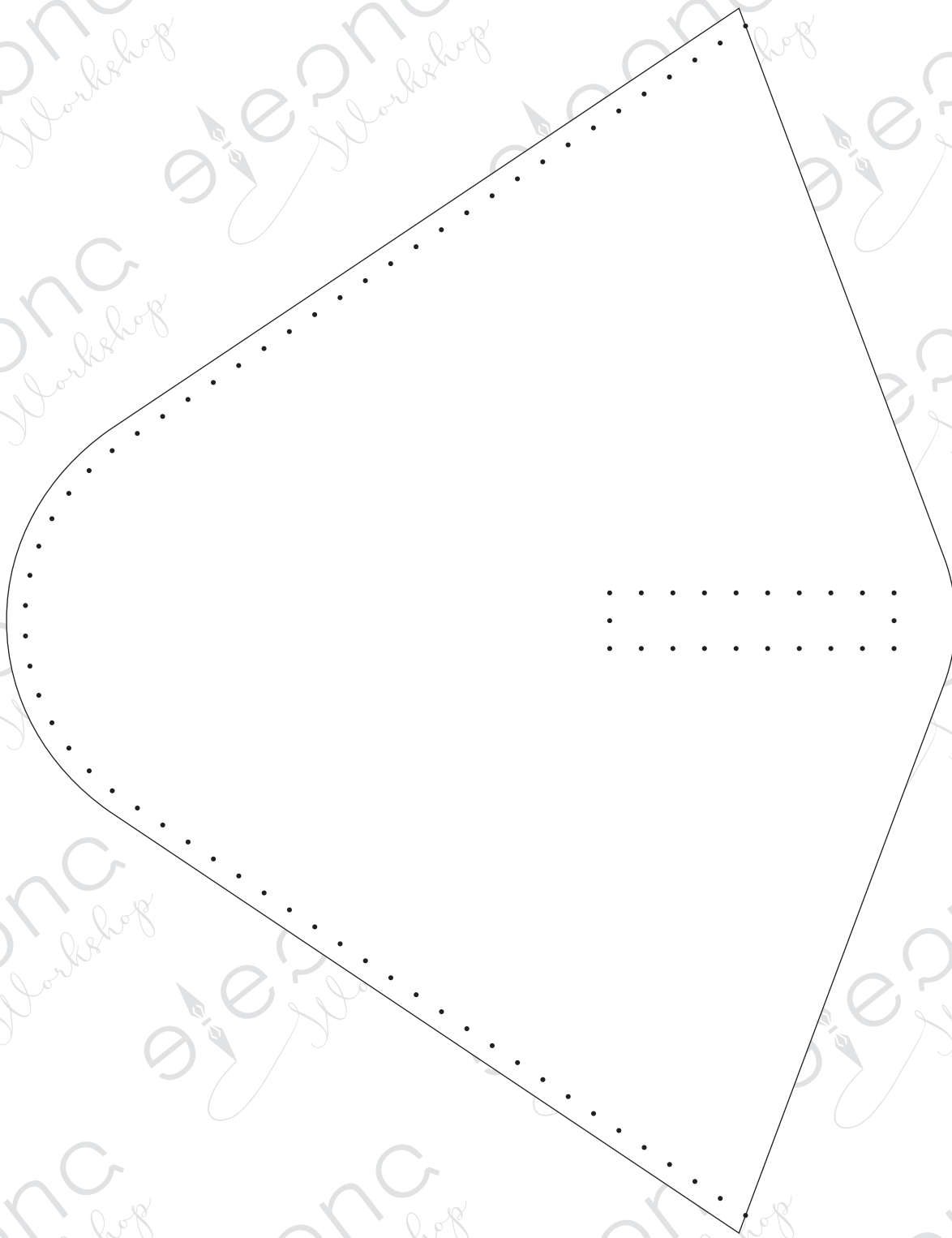

Rhombus Bag

©2022 by Eleana Workshop

