

# TEST PAGE

Select A4 in the paper size printing menu

Choose "actual size 100%" in the printing preferences

Make sure that sizes answer those that indicated below

Good luck!

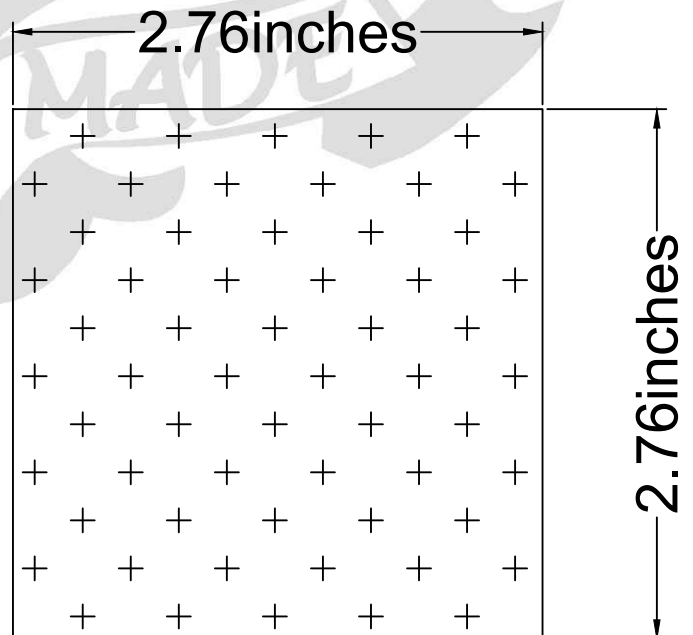
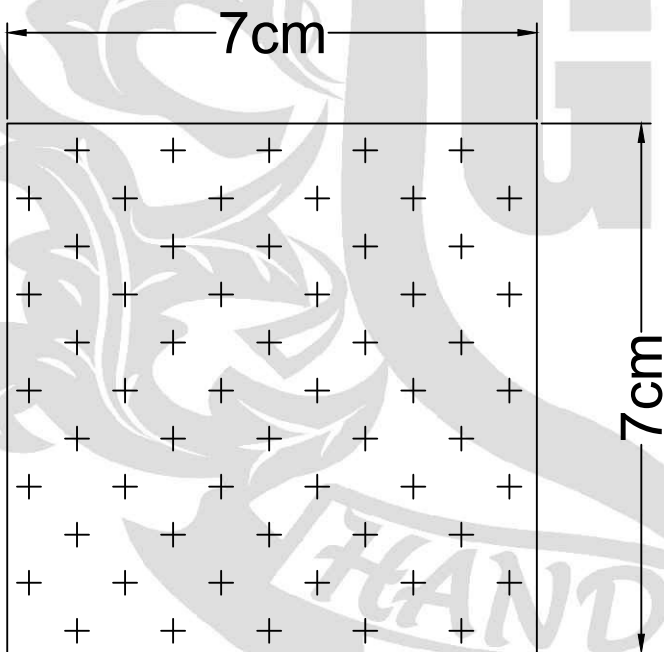

Leather bag PDF  
Recommended  
Leather:  
2mm 5oz

Materials you  
need:  
zipper 50 cm x  
19.68 in  
2 x 30mm D rings  
2x 30mm swivel  
hook snaps  
2 x 30mm buckles  
Waxed thread  
0.55mm and  
1mm 80 meters

I will be  
grateful for  
subscribing to  
my YouTube  
channel thank  
you..

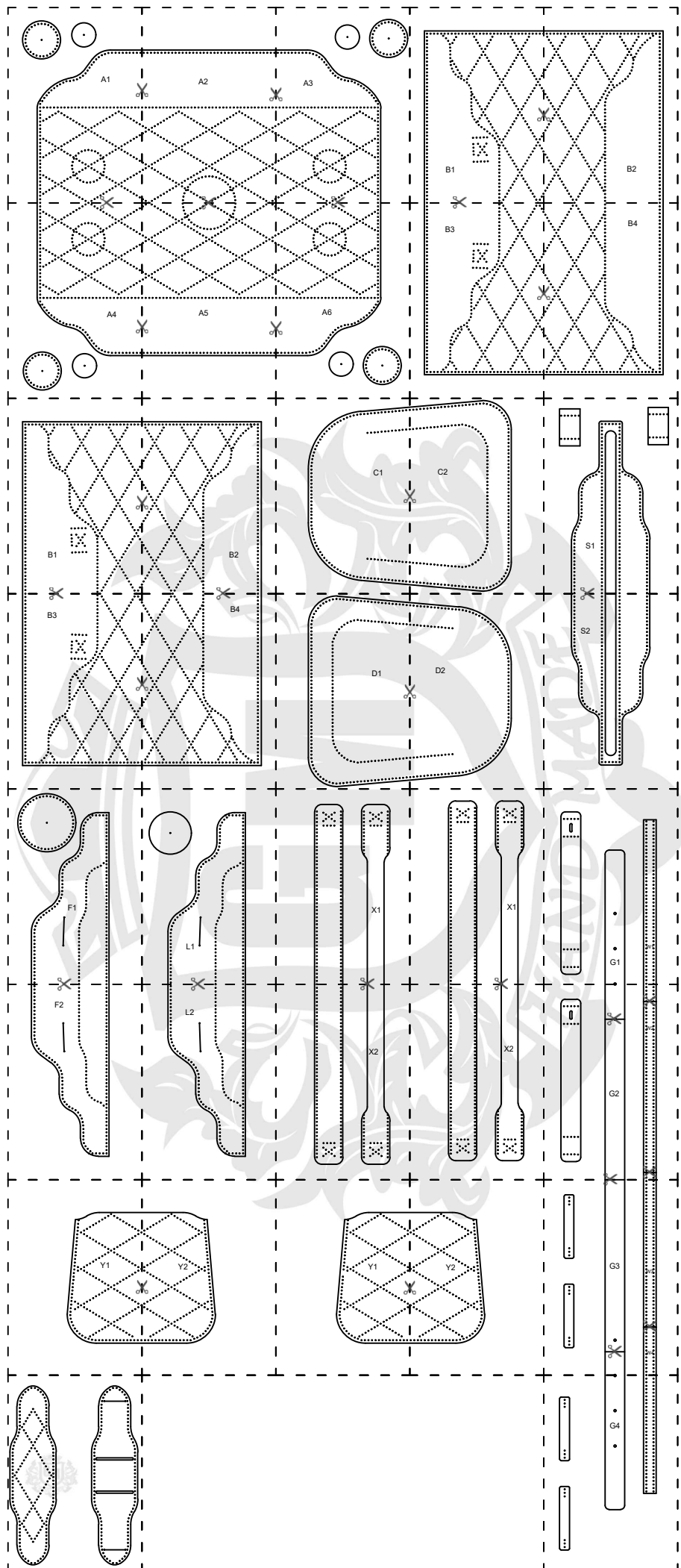

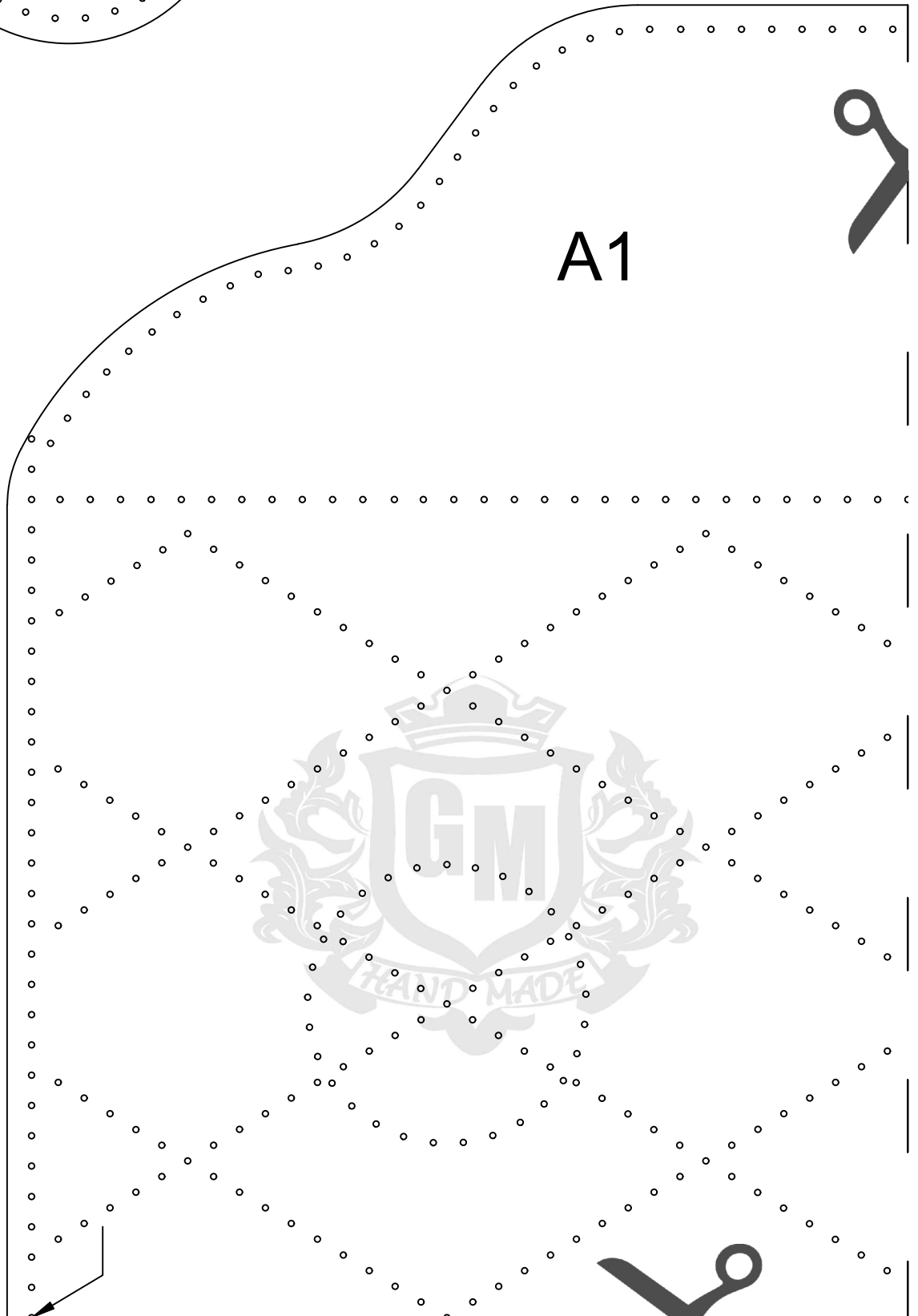
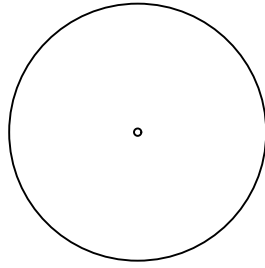
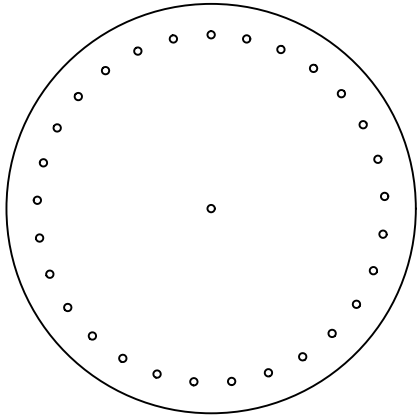

A1

A2



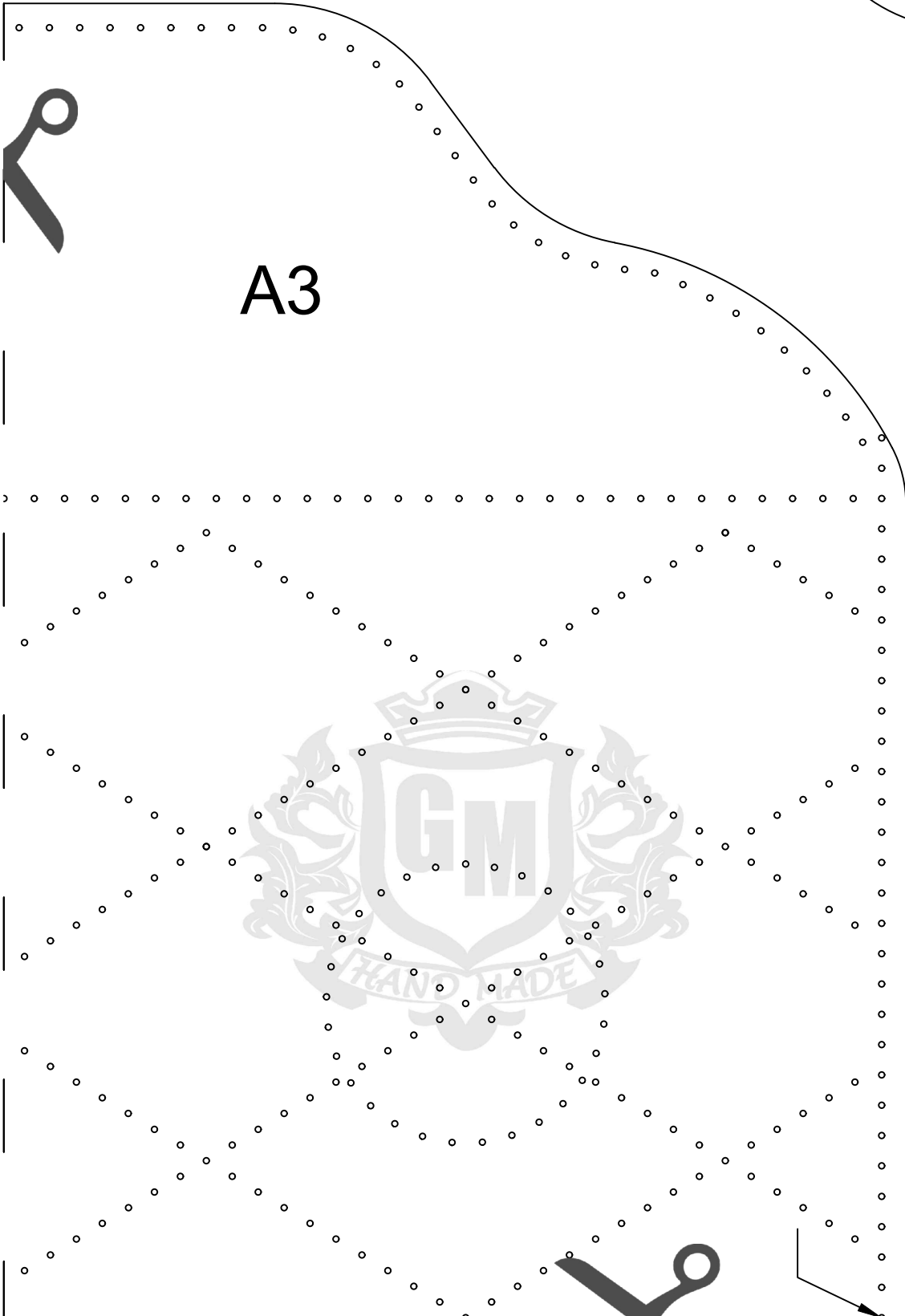
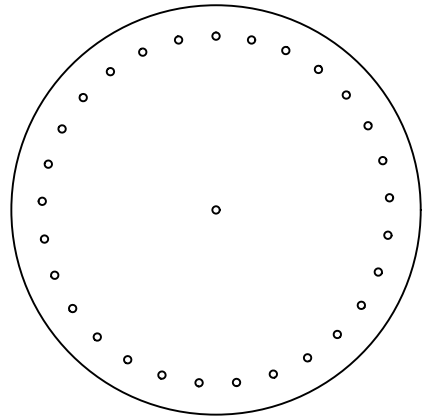
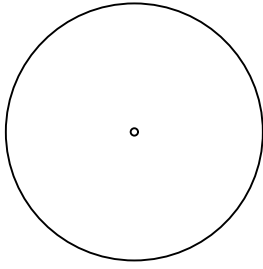

A3

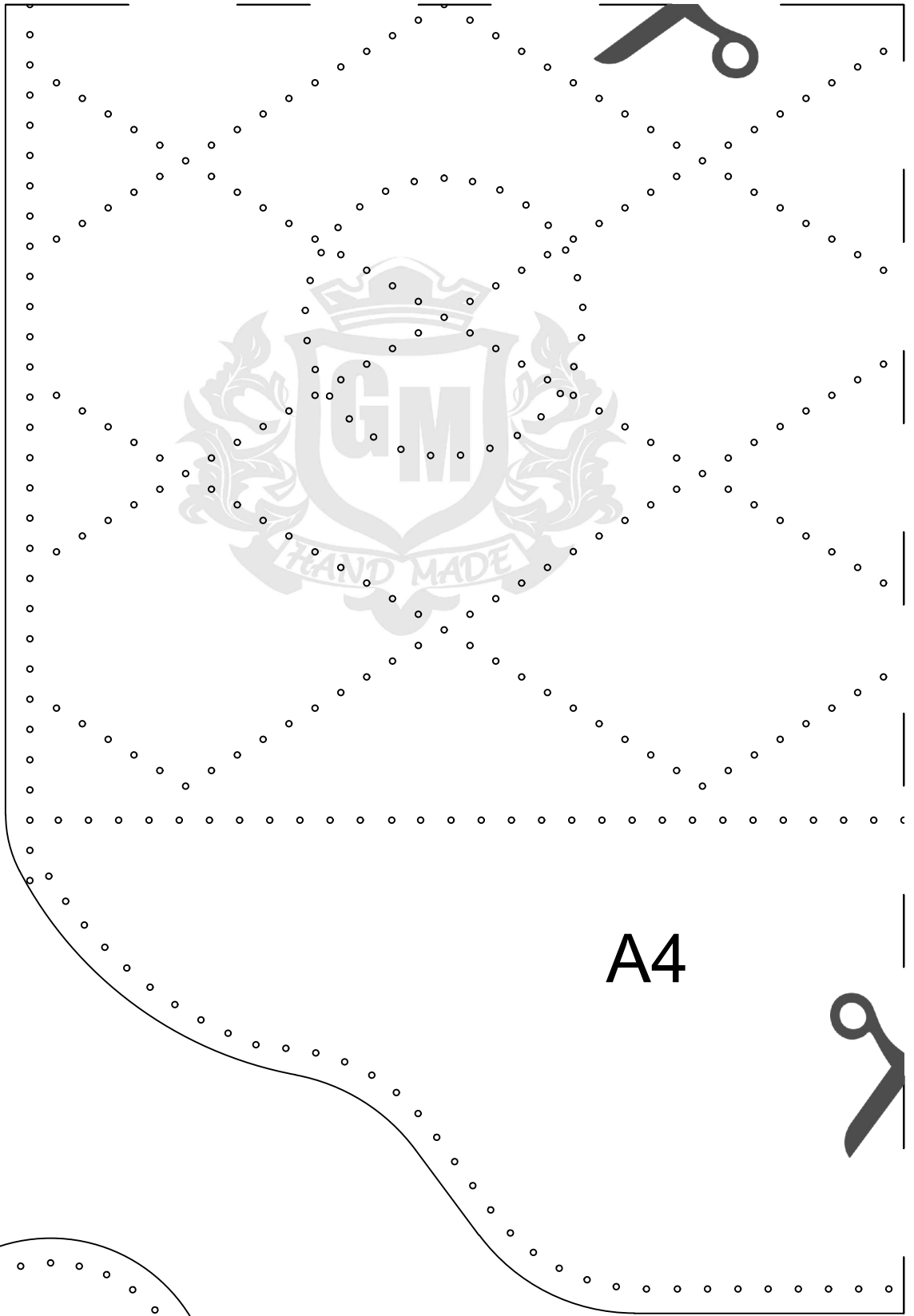

A4

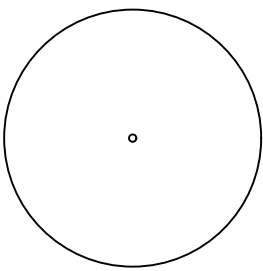
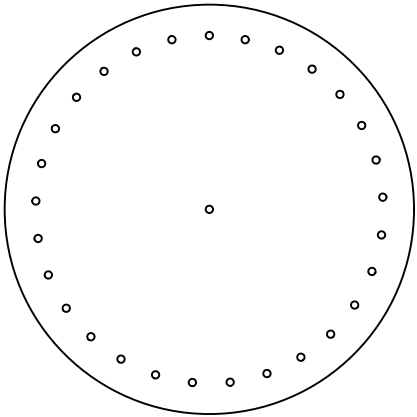

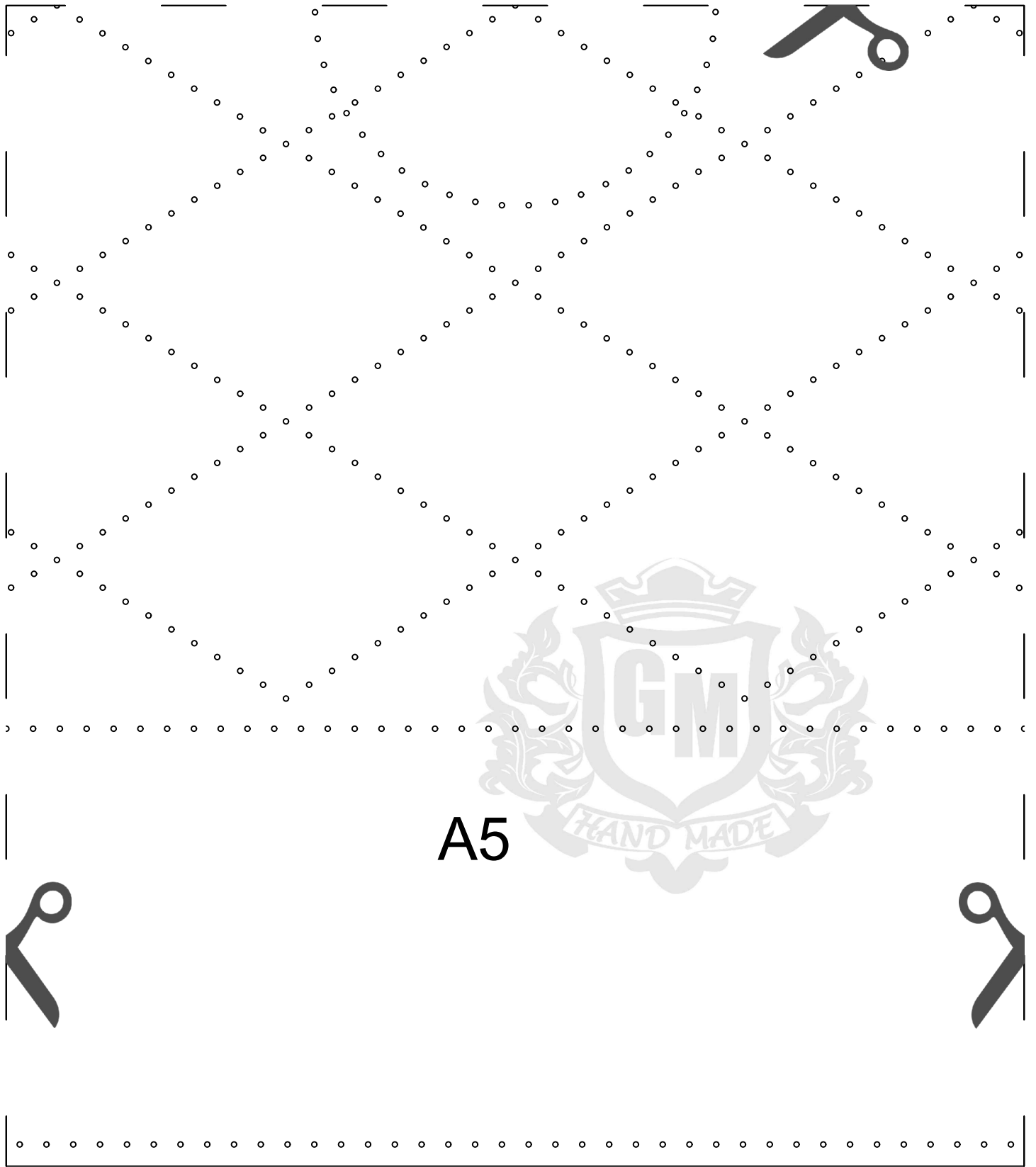

A5

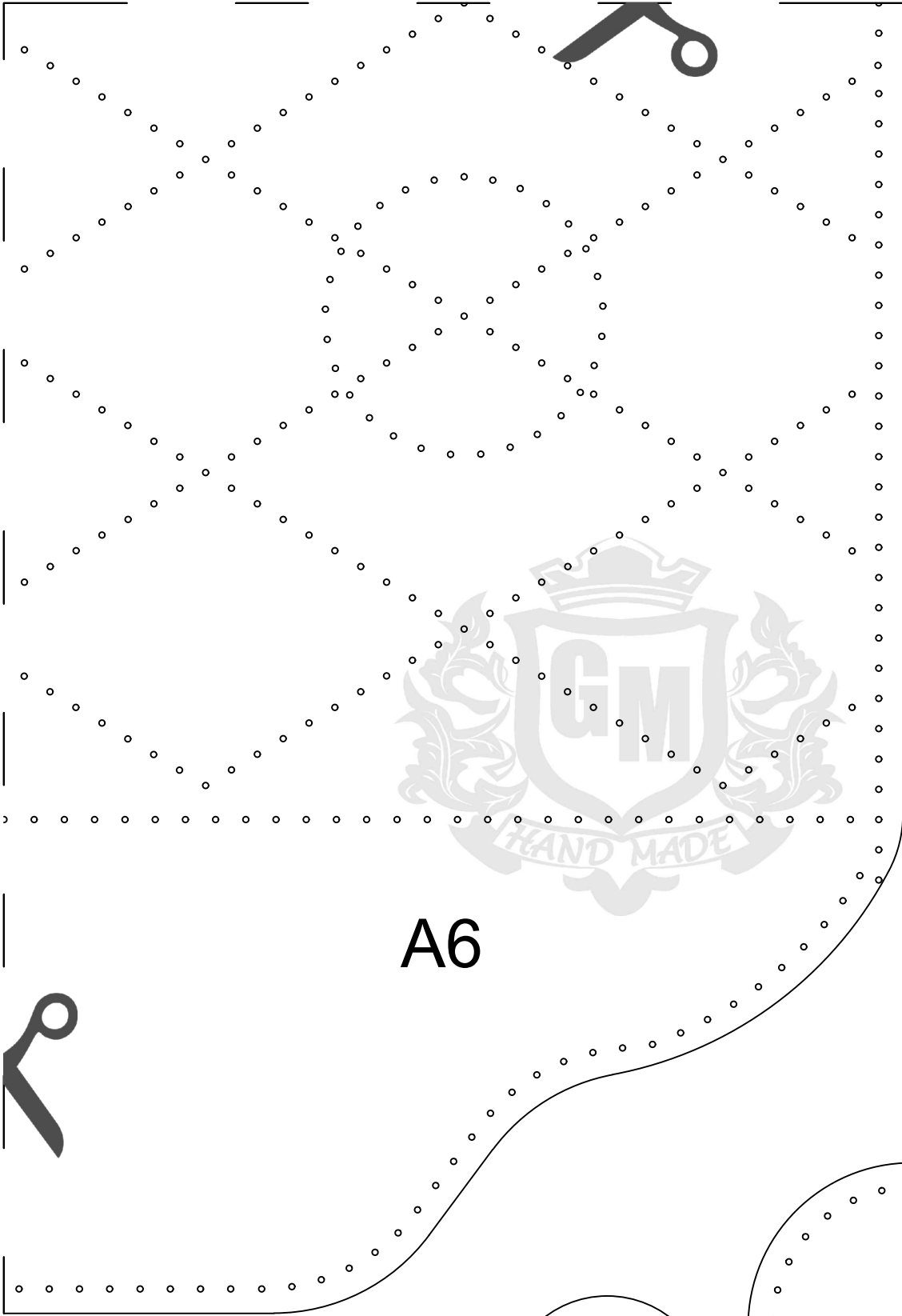

A6

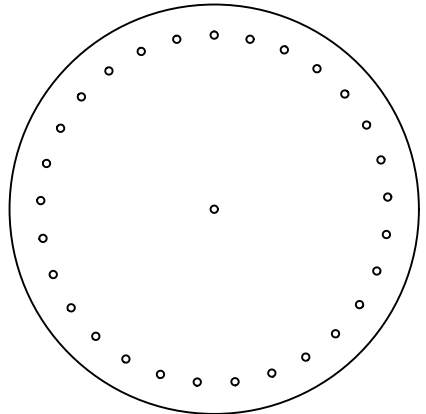
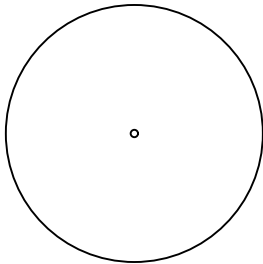



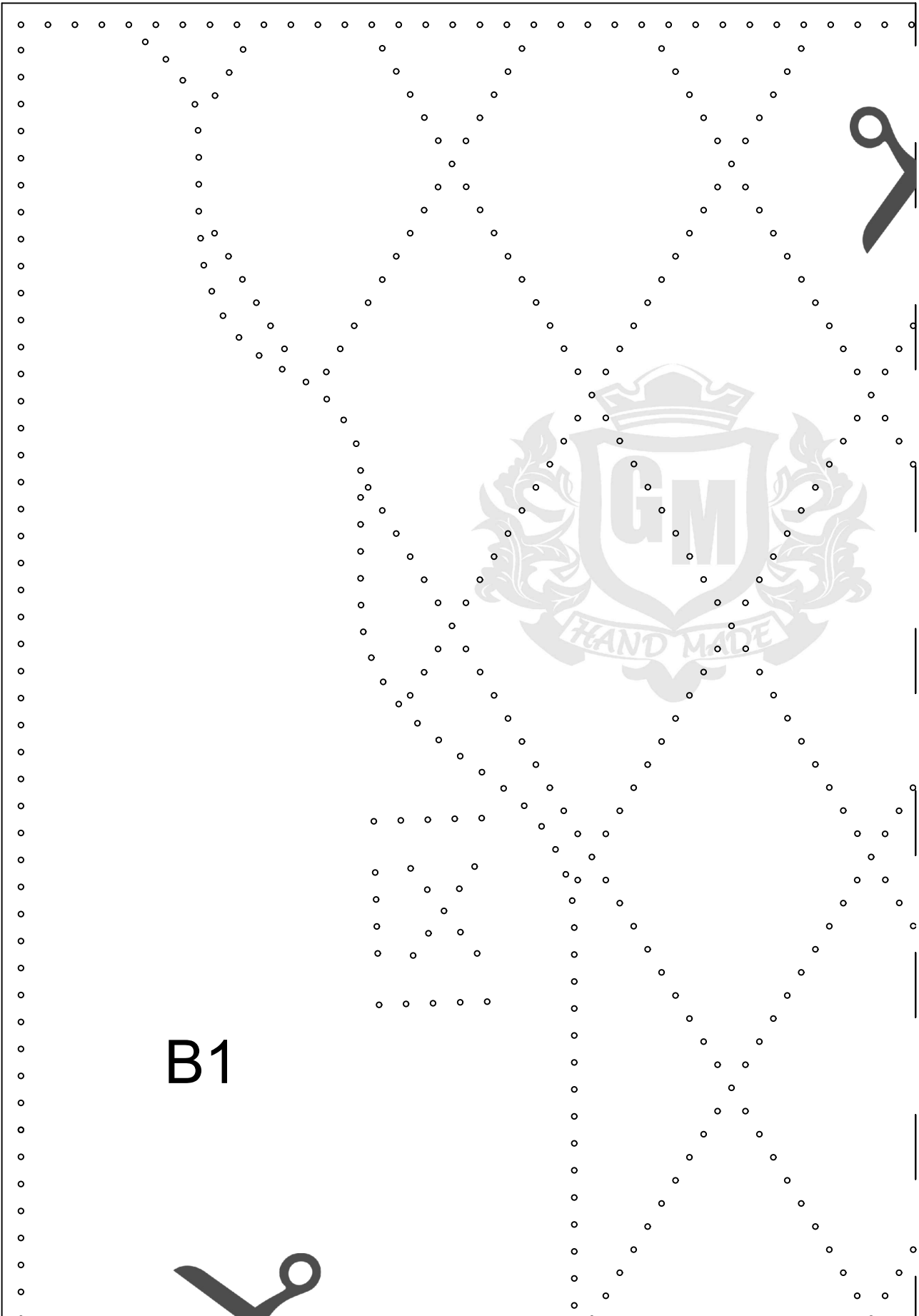

B1



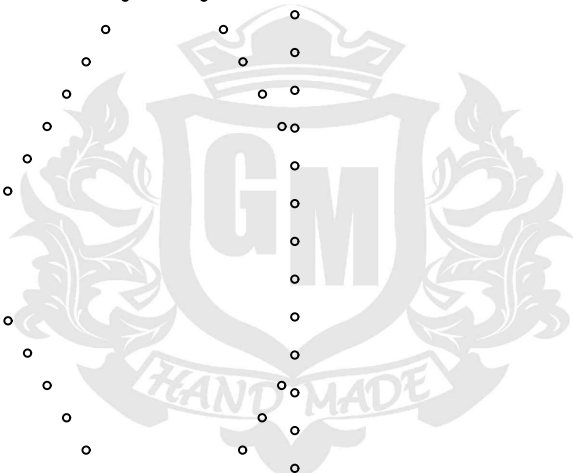
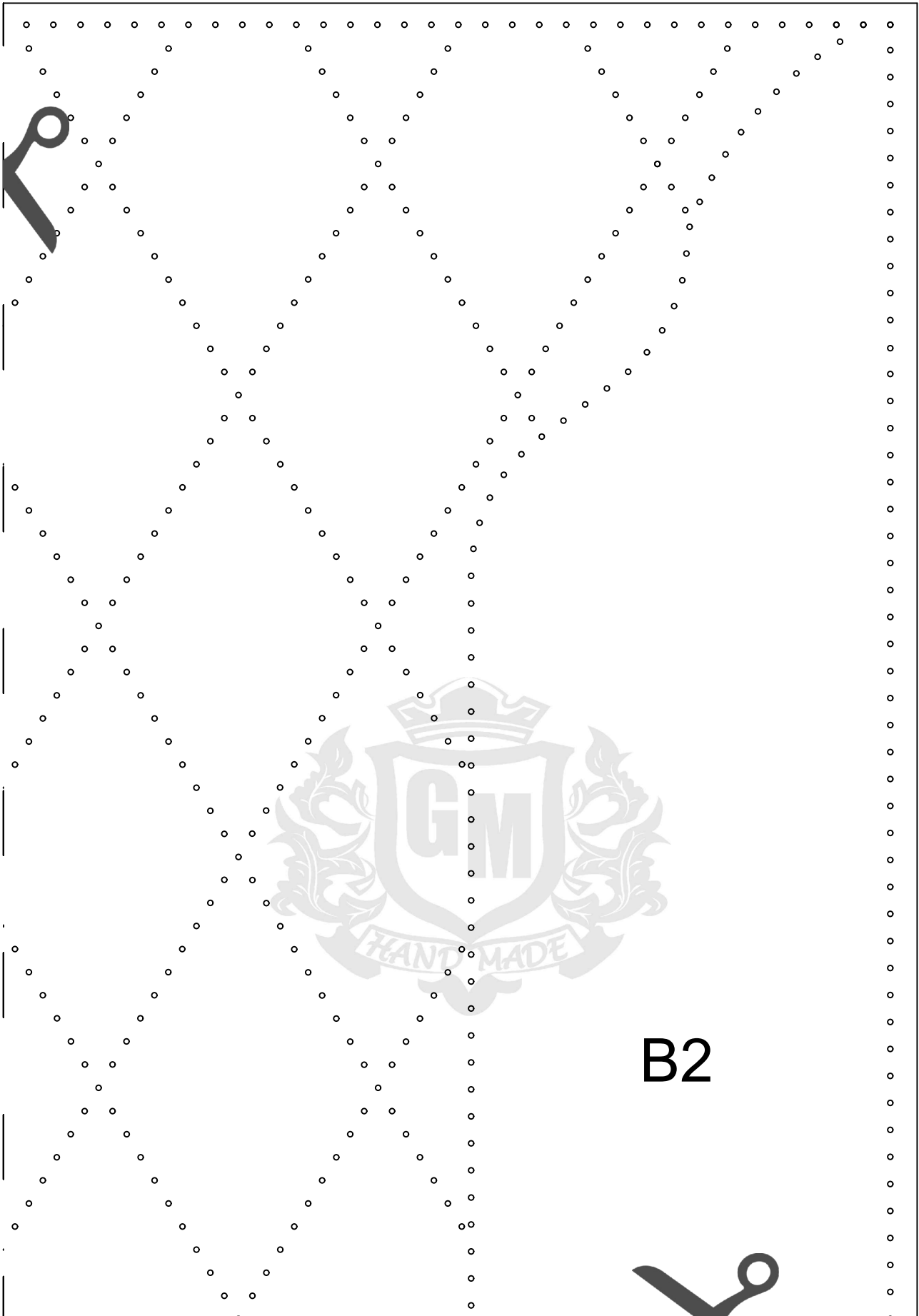

B2



B3

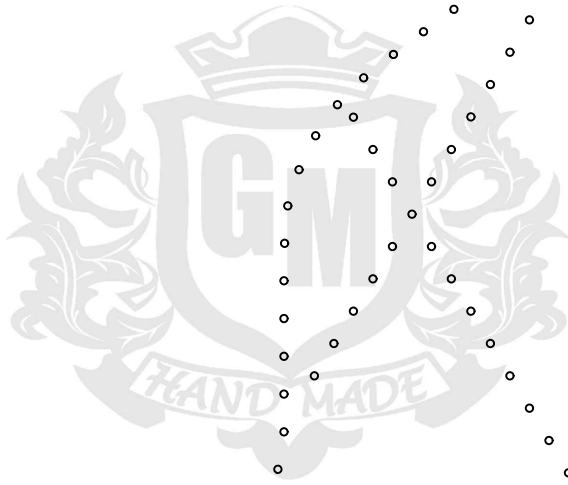

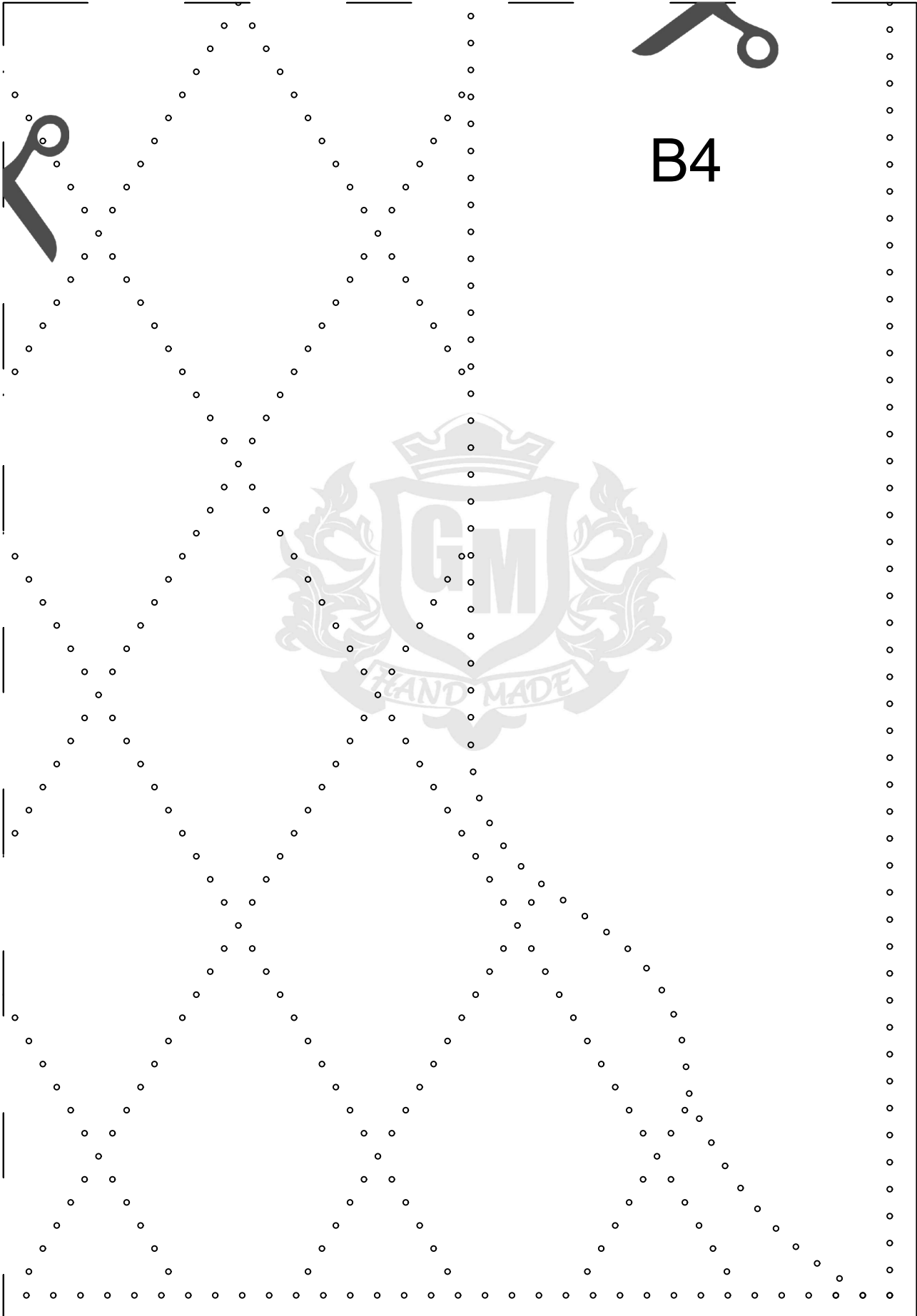

B4

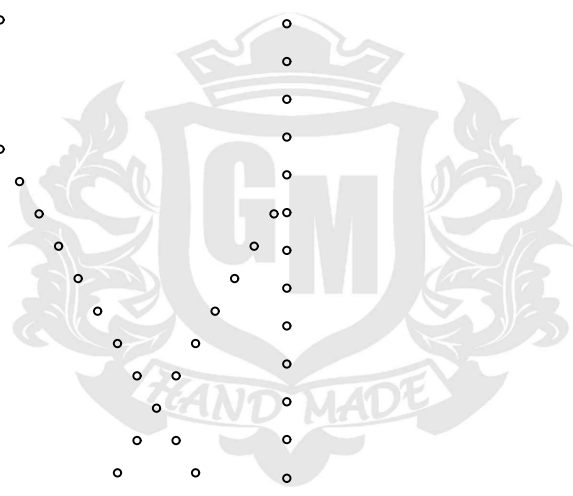

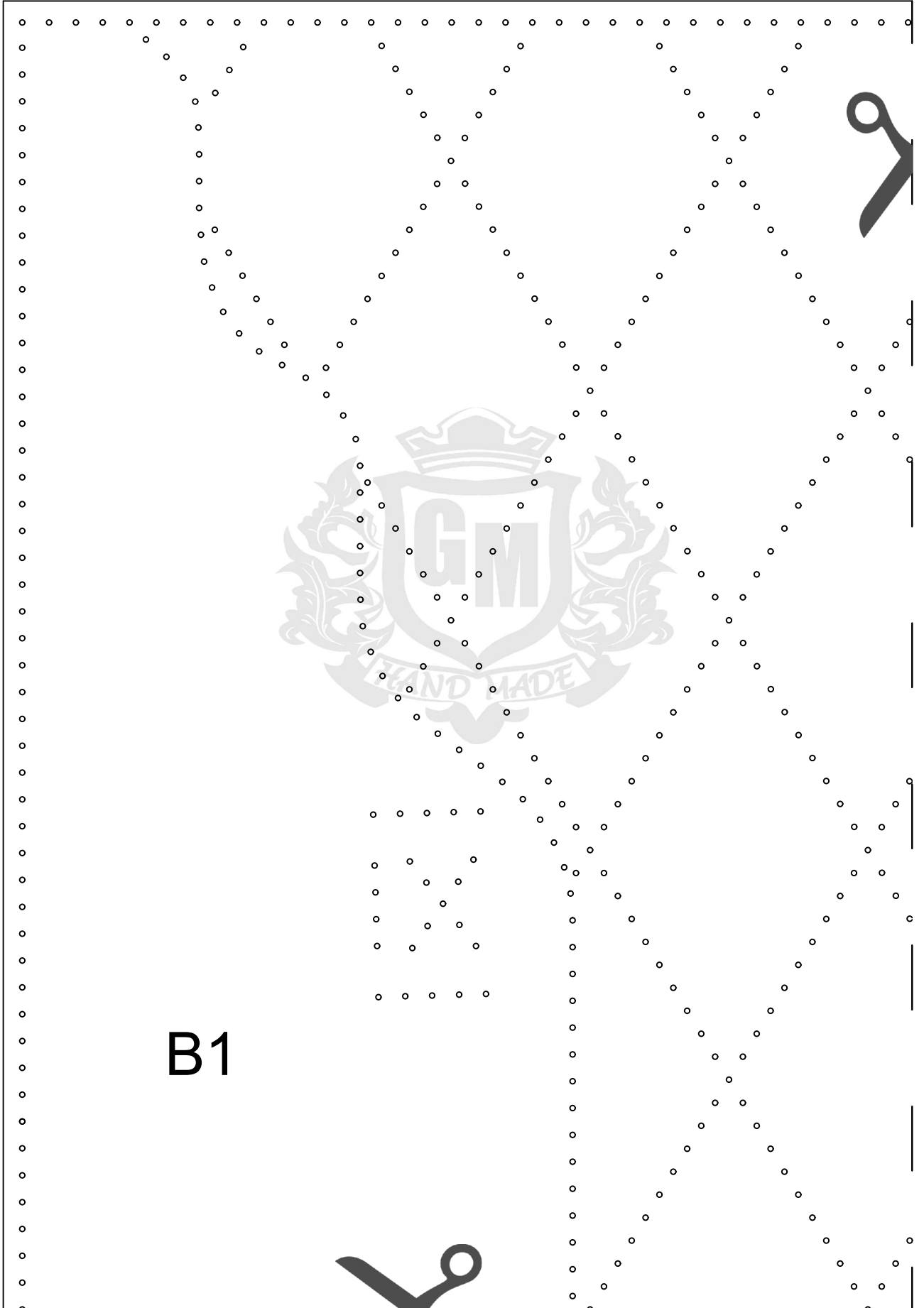

B1

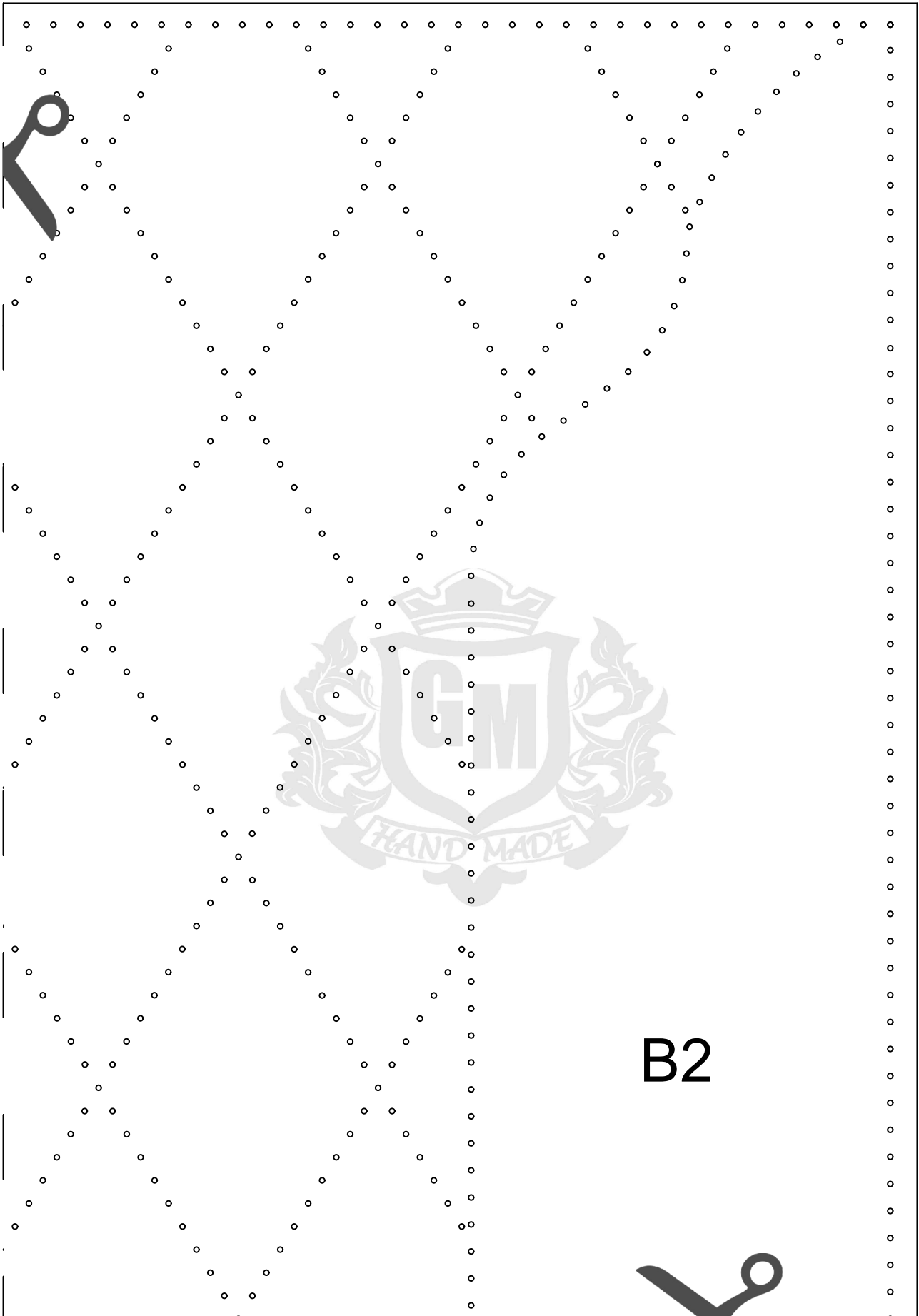

B2





B3

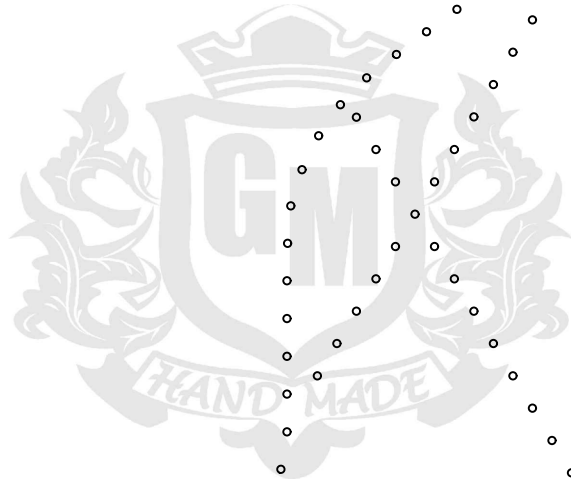



B4

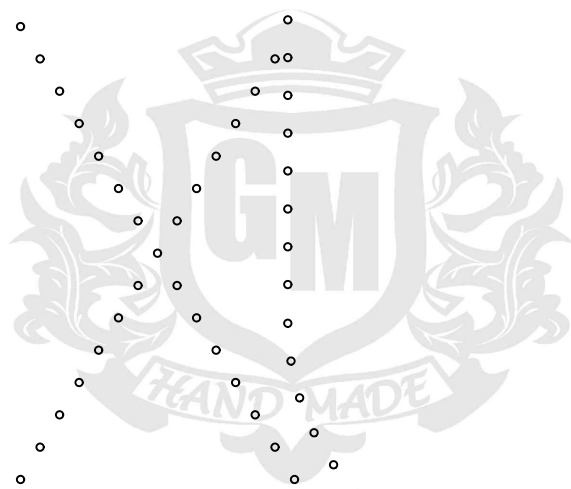



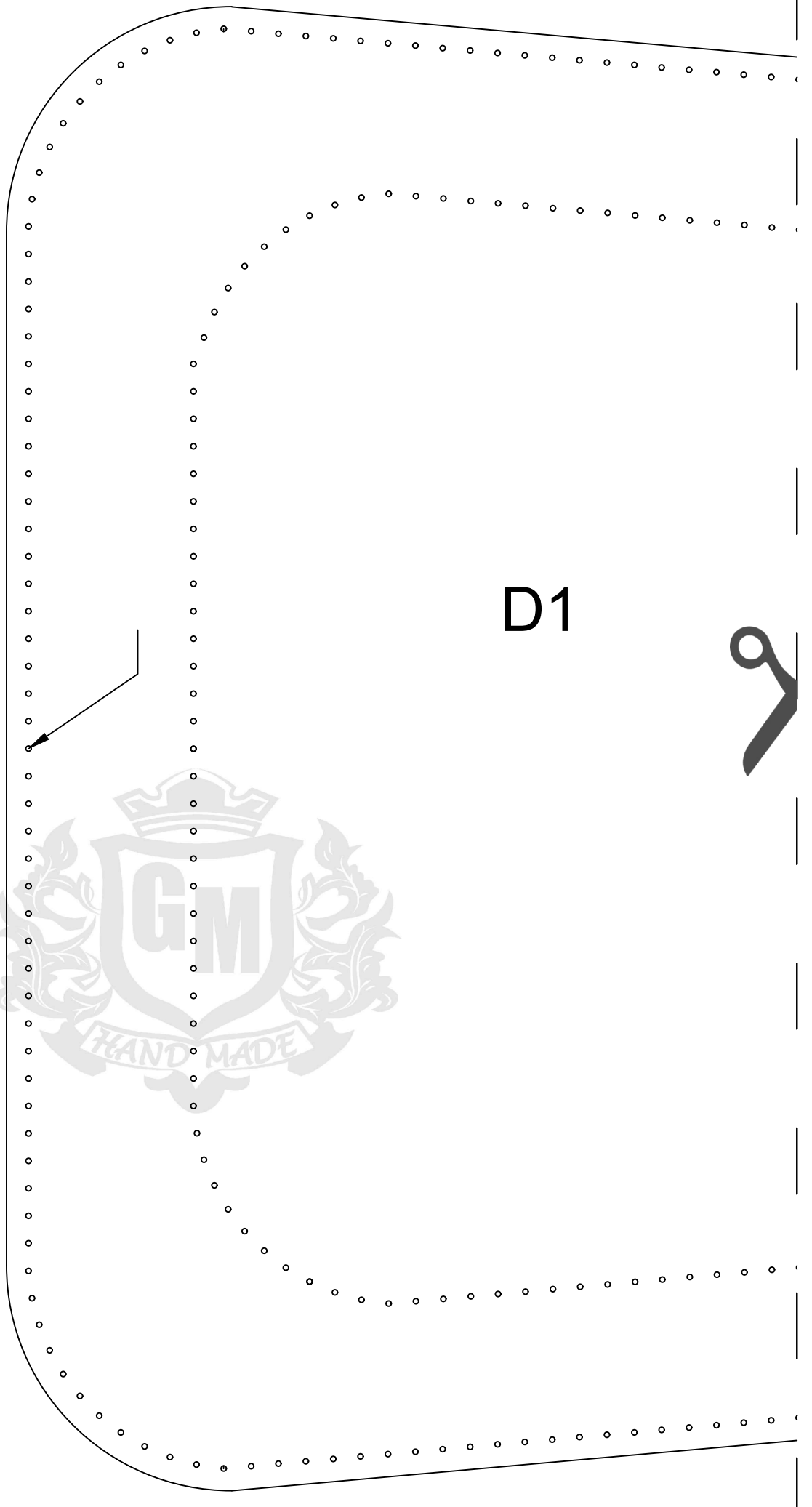

D1

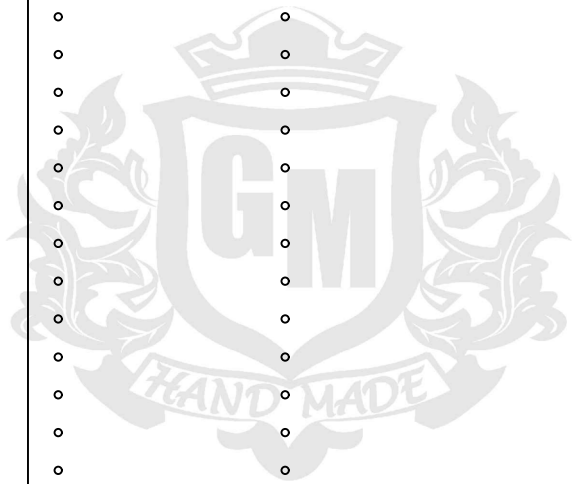



D2



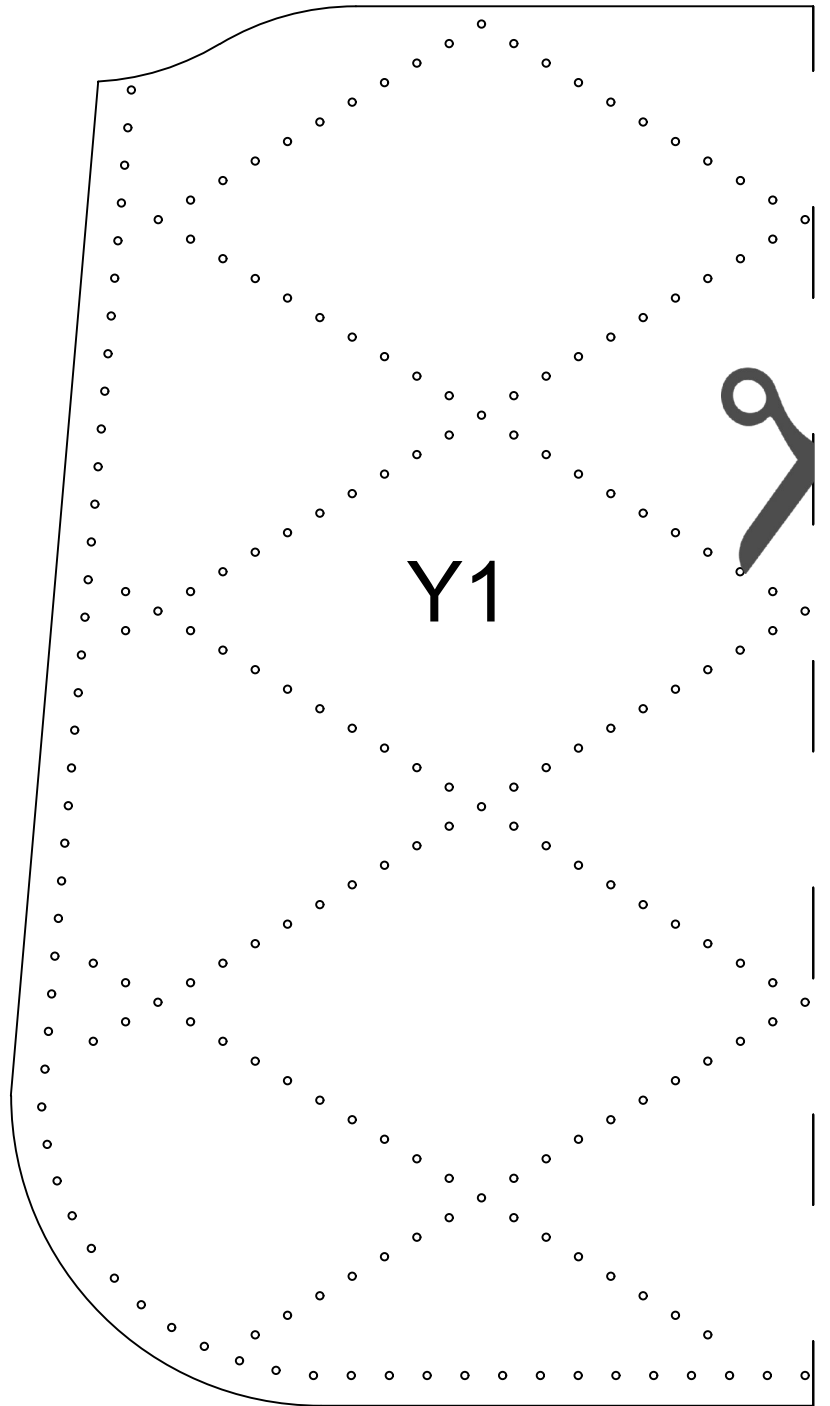

Y1

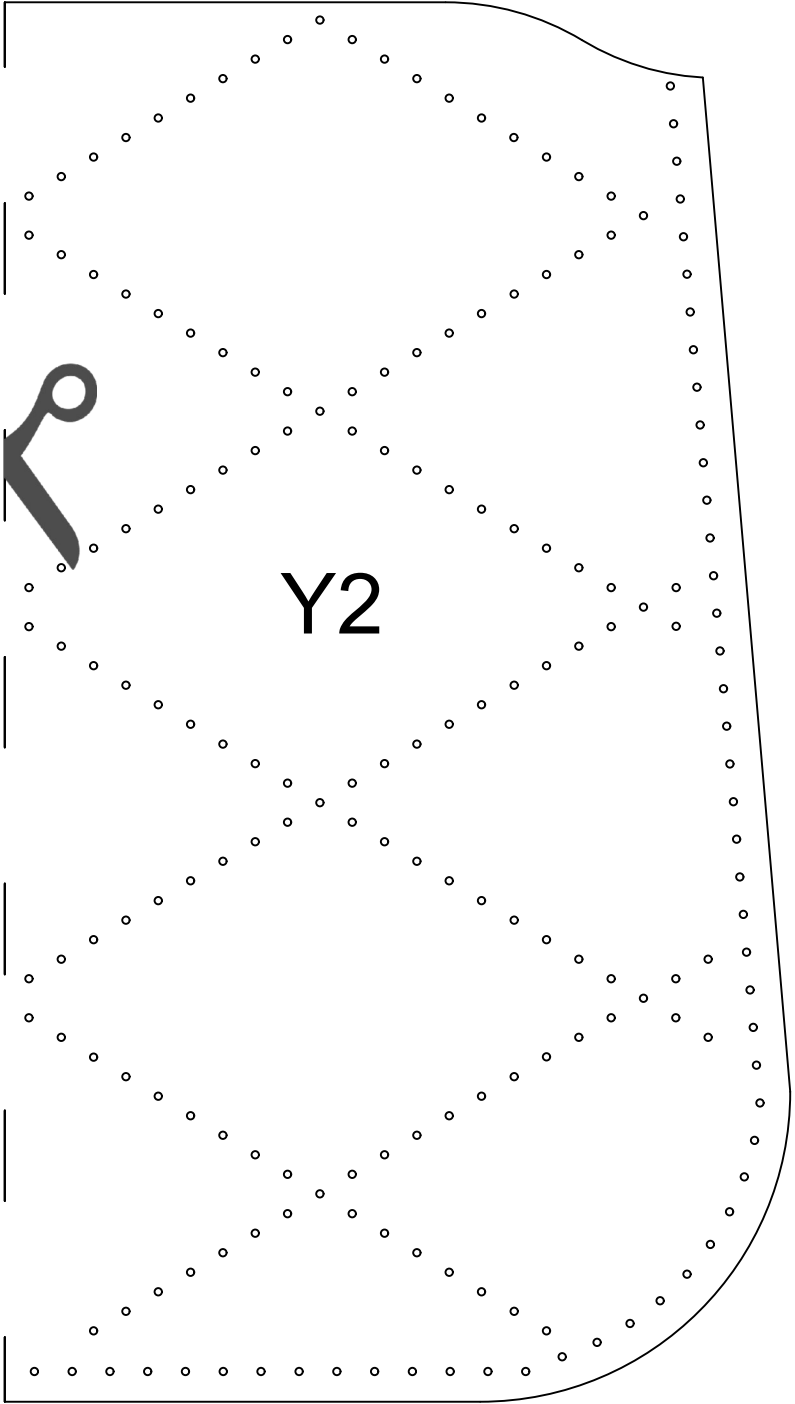

Y2

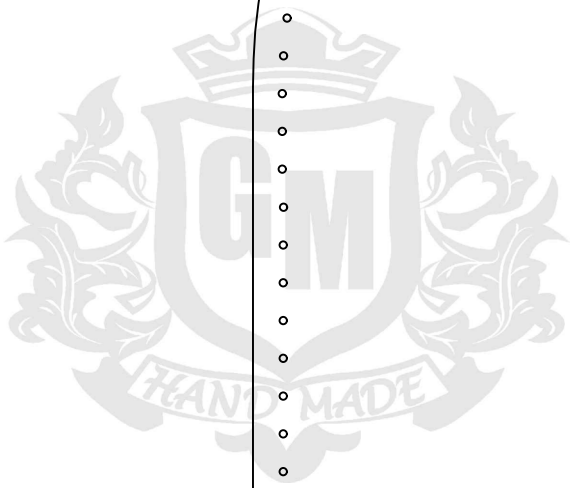

C1



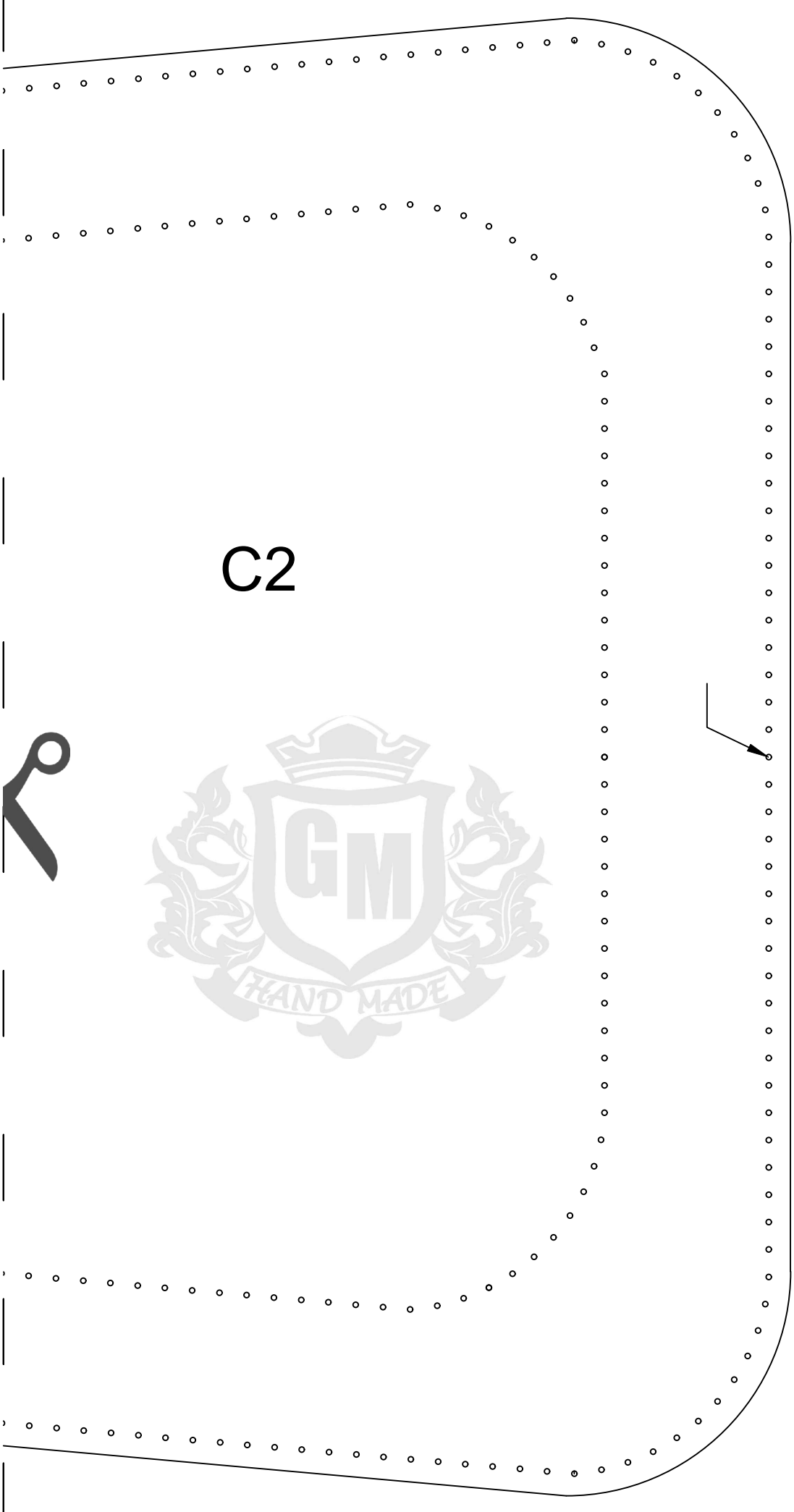

C2

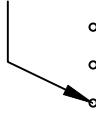

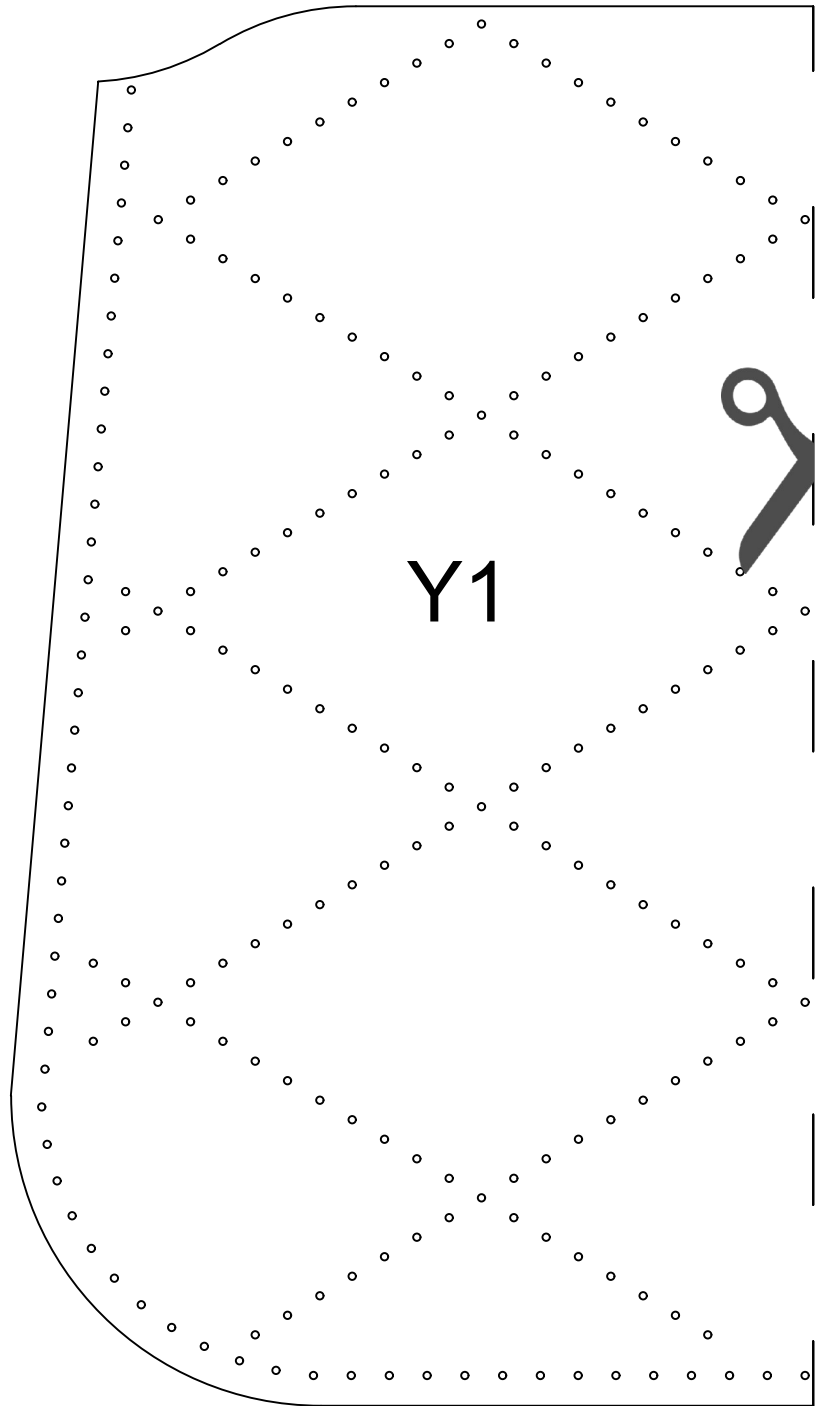

Y1

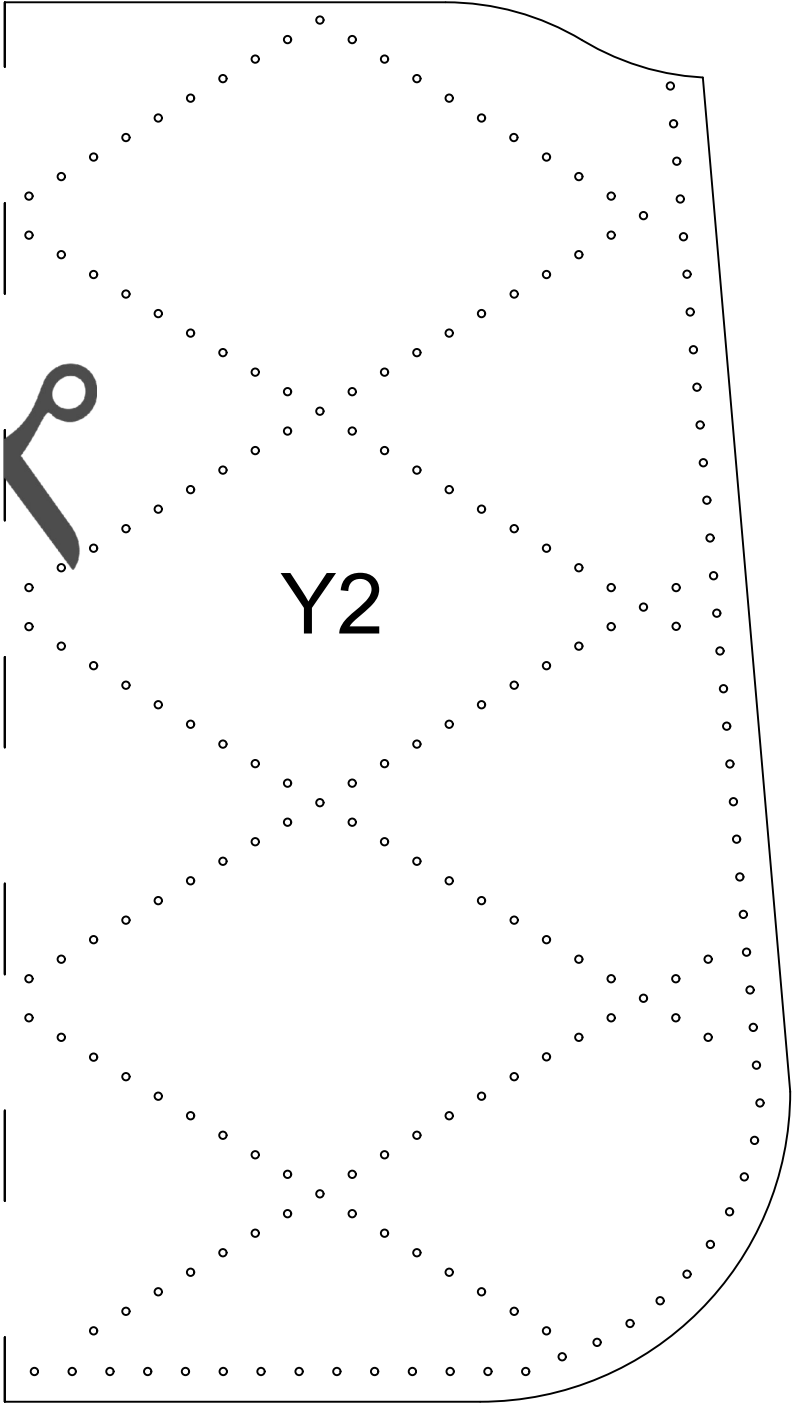

Y2



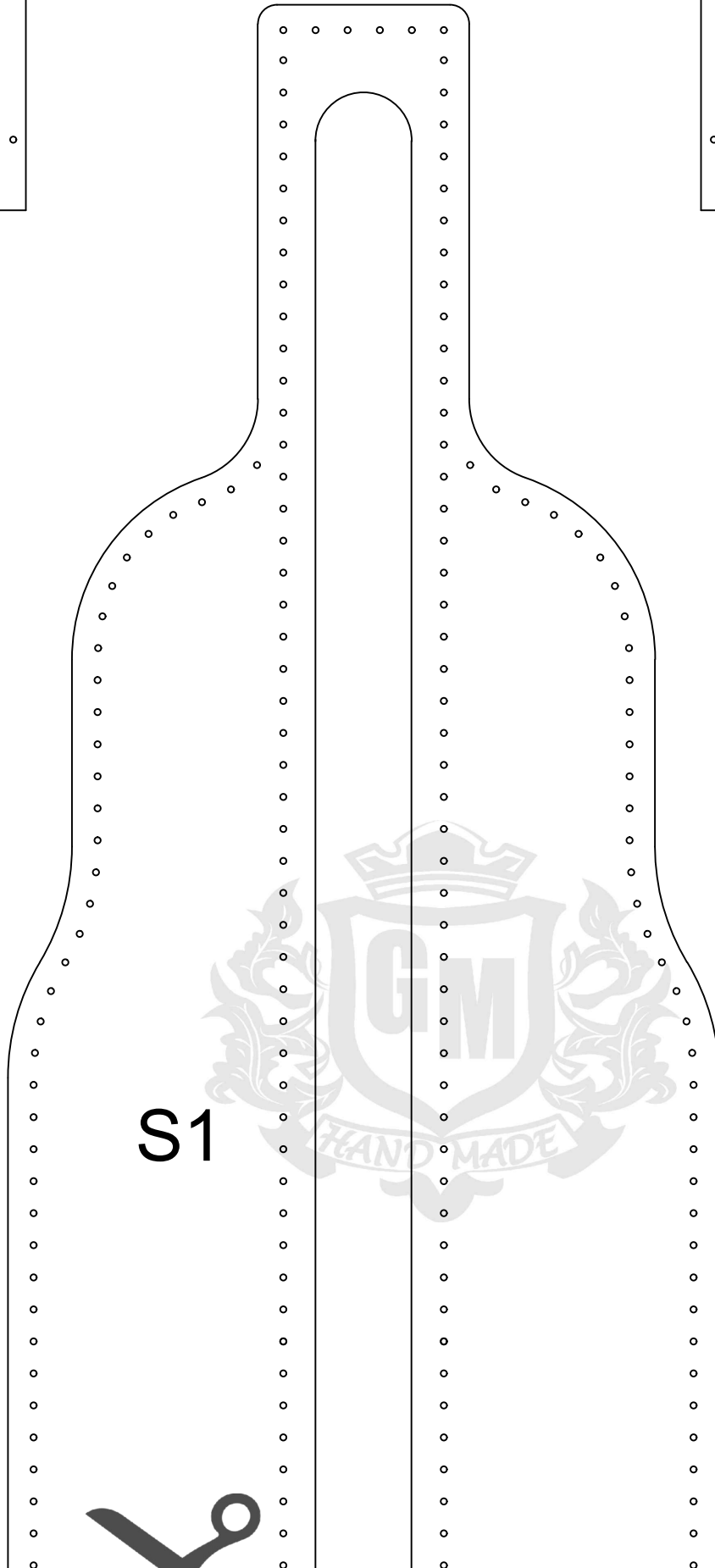
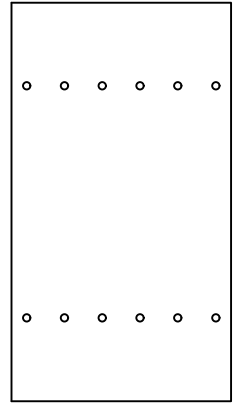
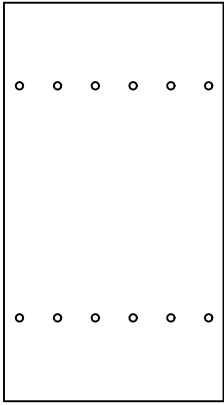

S1

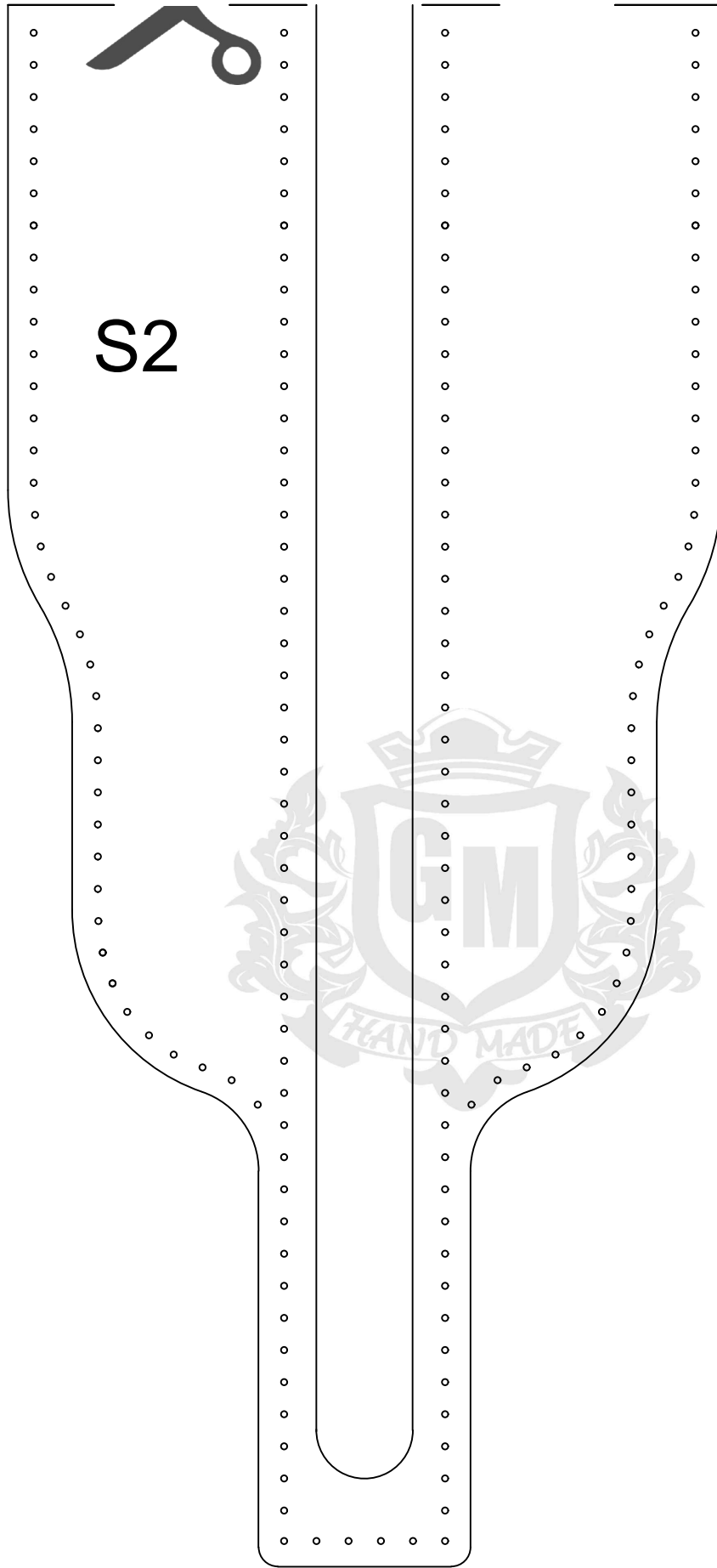

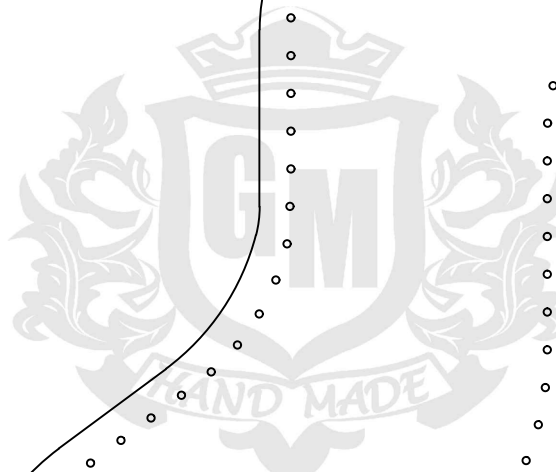
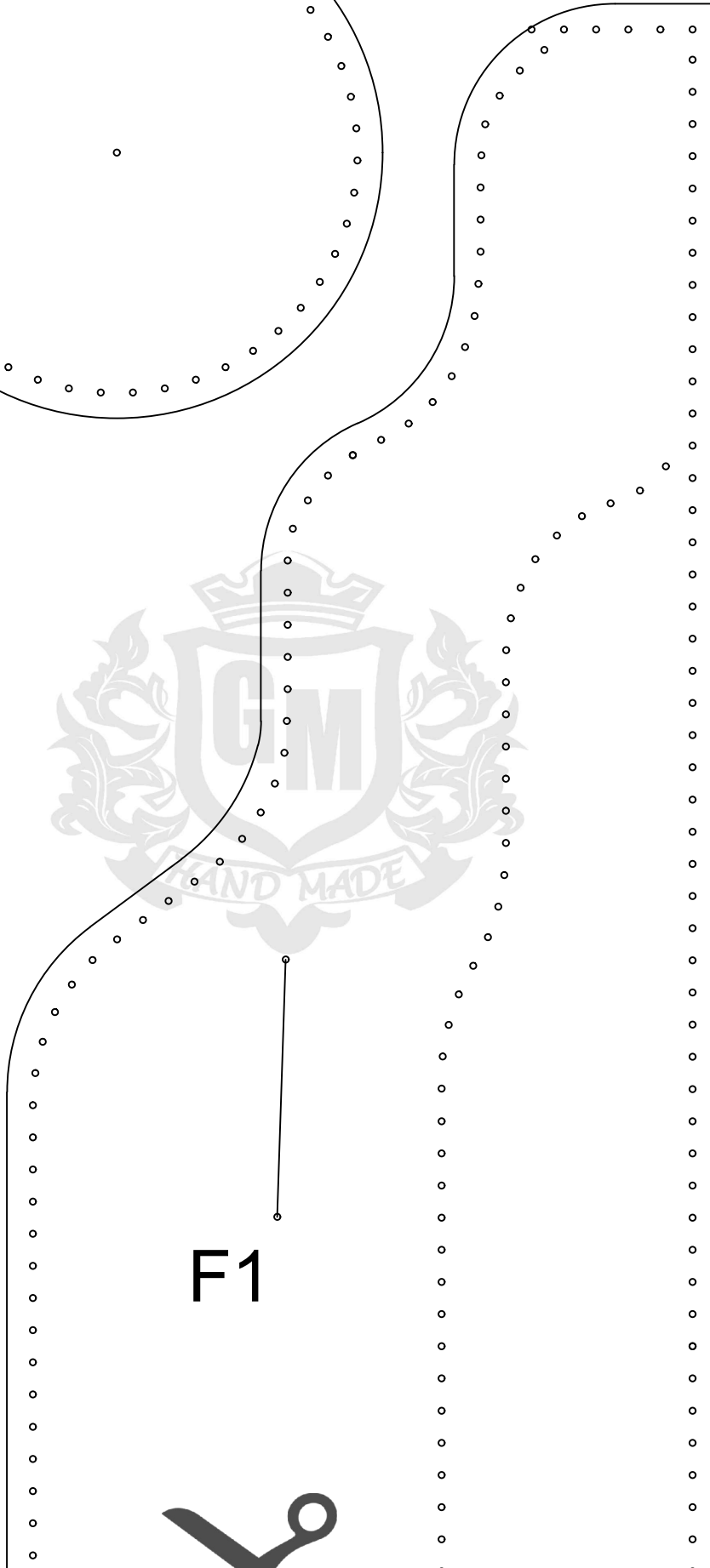
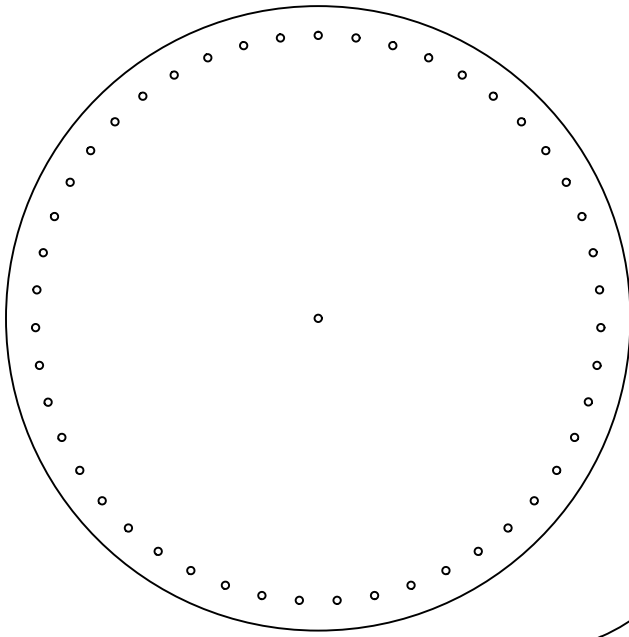

F1





F2

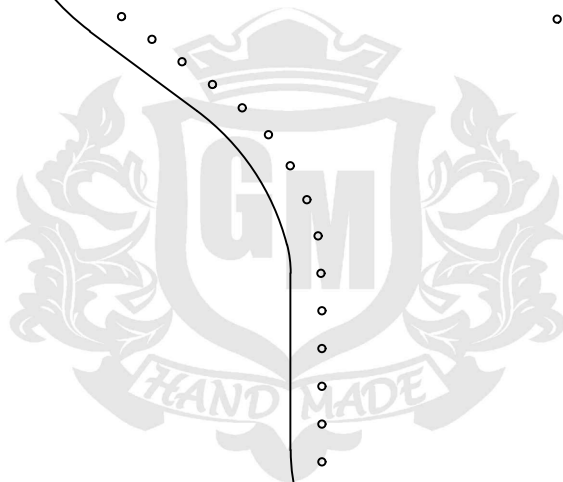
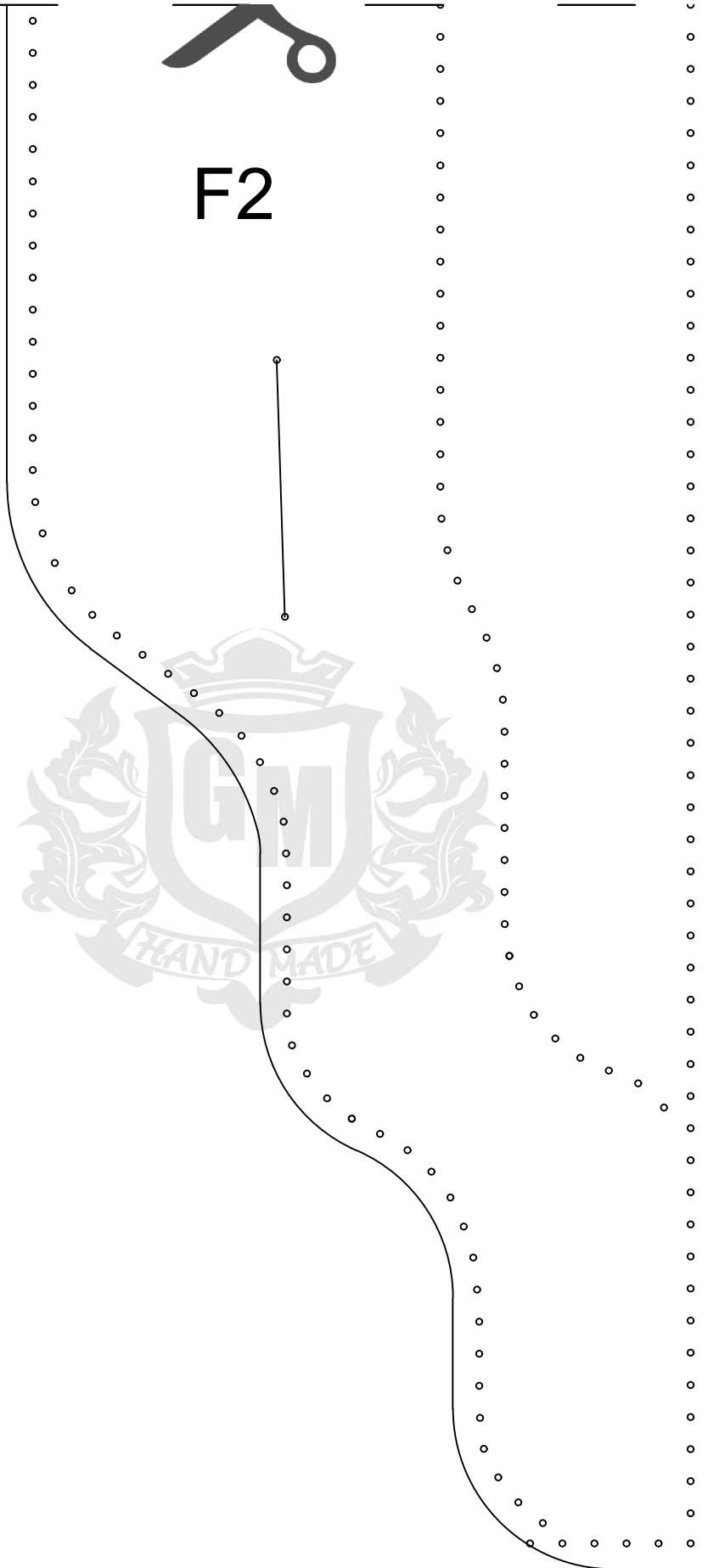

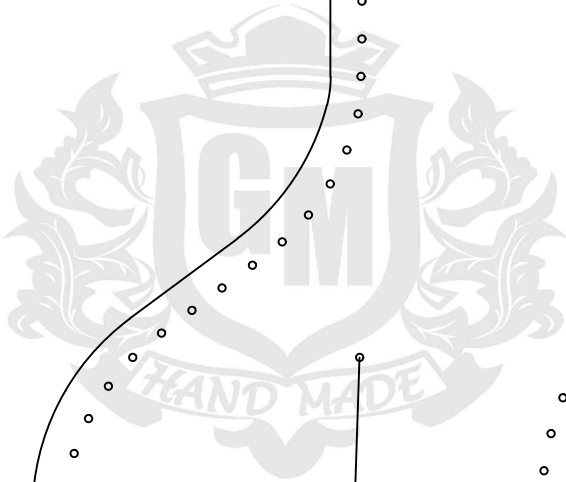
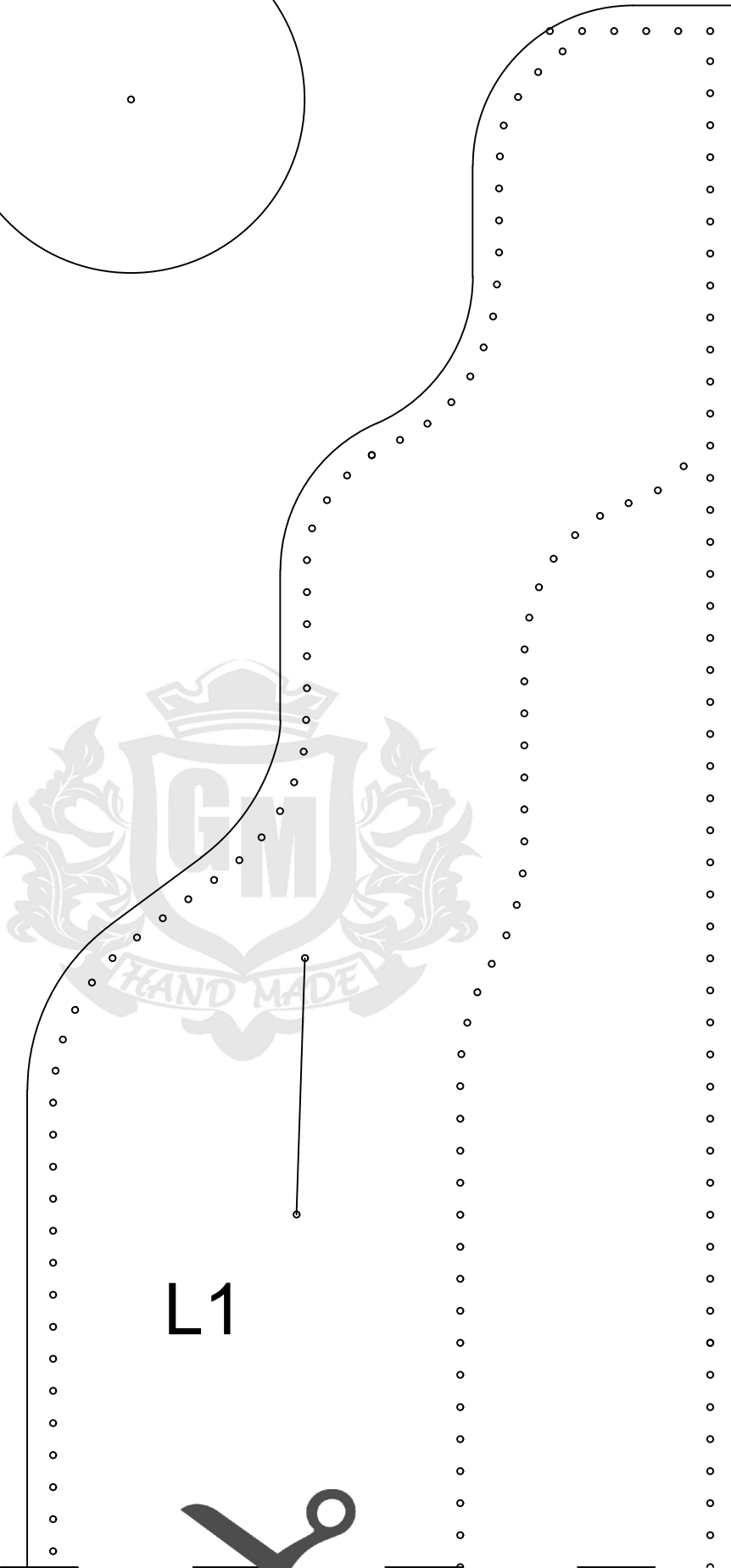
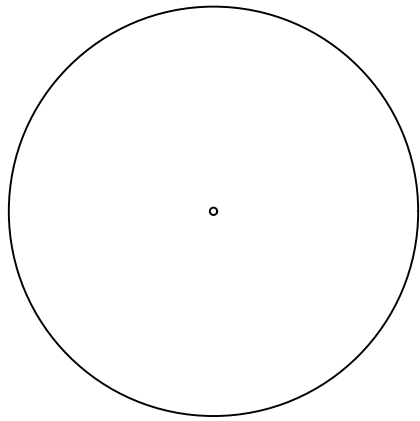

L1





L2

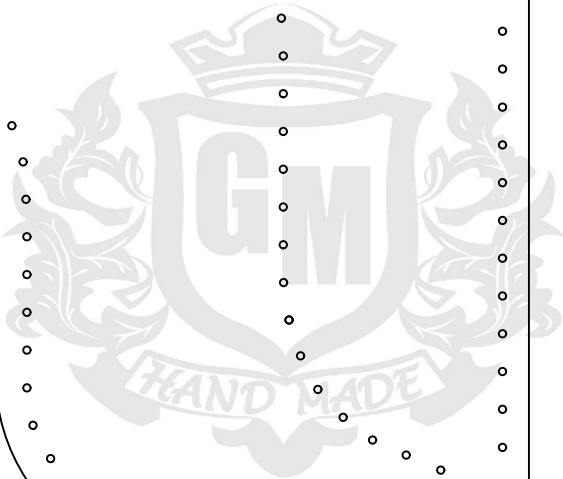

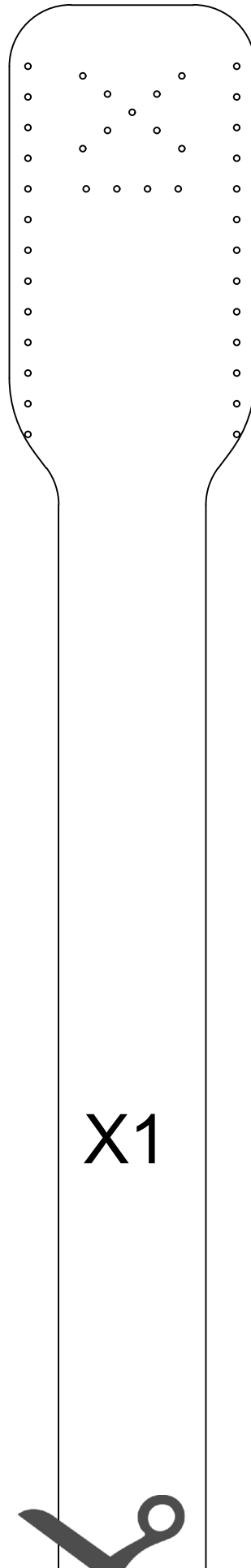
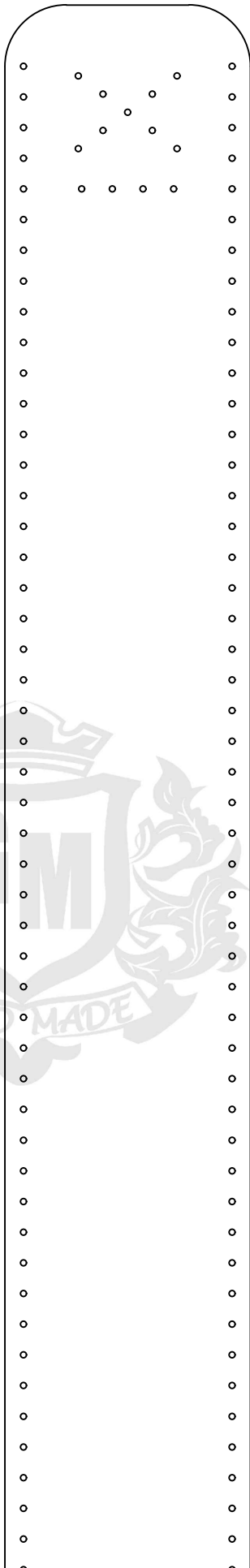

X1

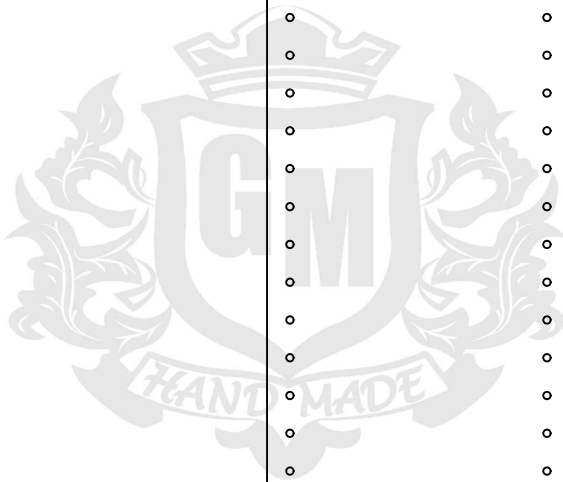

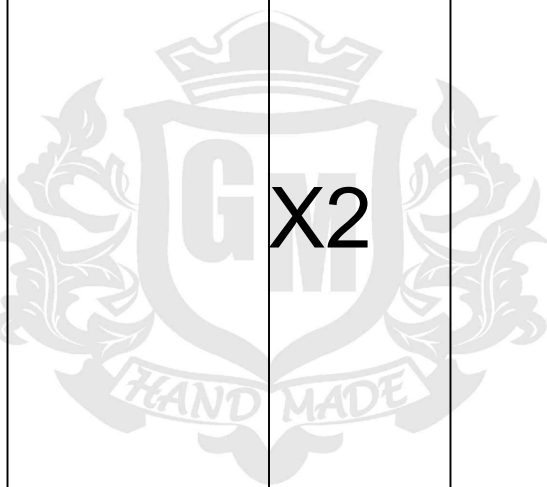
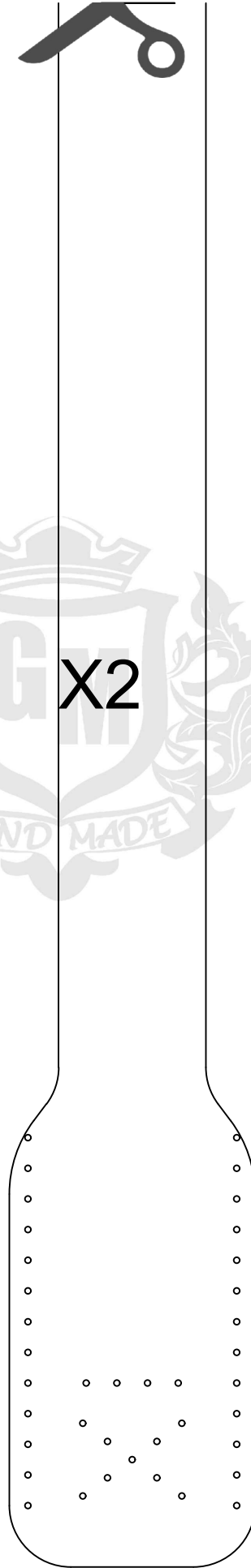
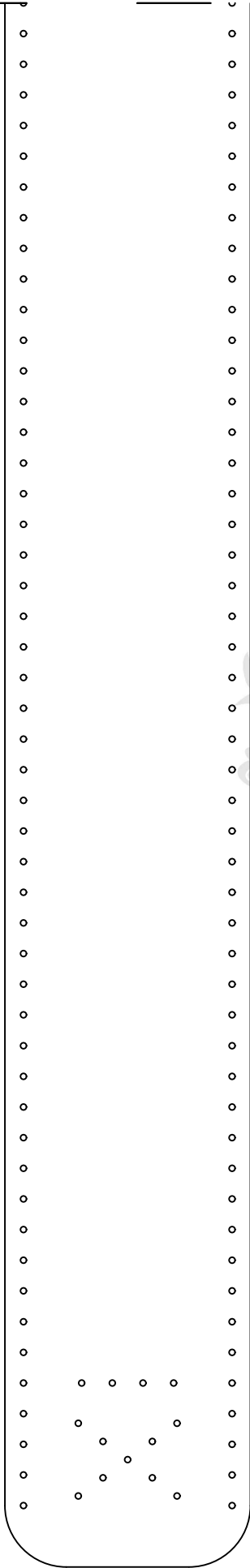



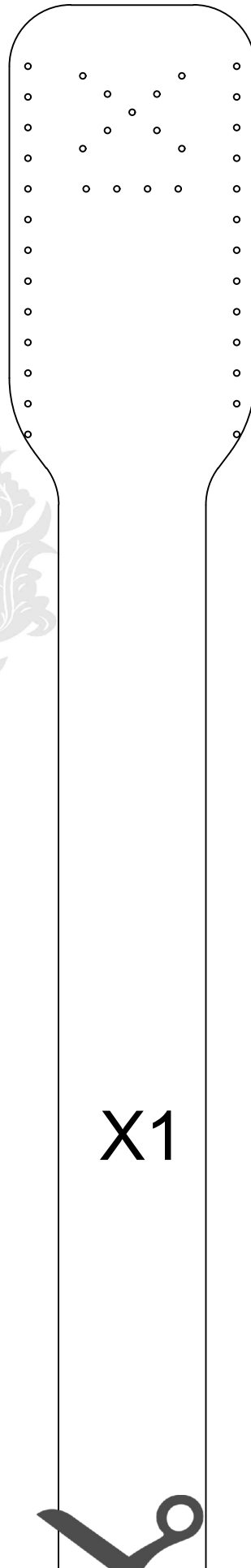
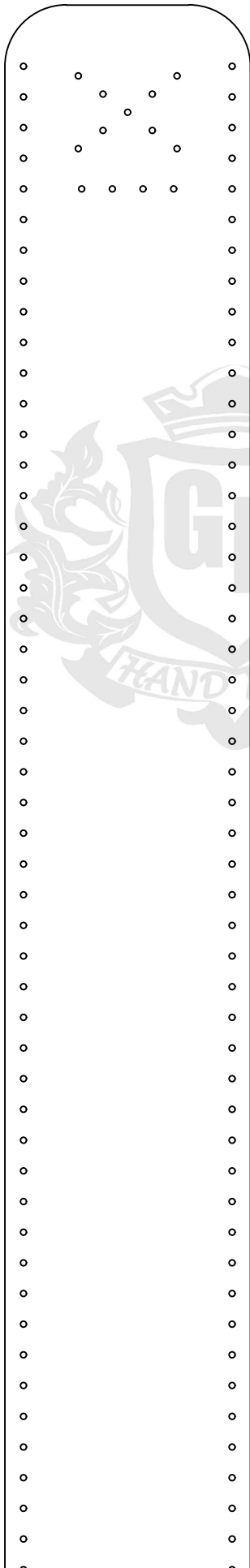

X1



