

CUL 17 T f b - | k d e k i b ^ e b > 3

B | 5

O) - b f - b s - ^ j | k d e b - f b b a b

CUL 17 C b - B > 2

D 19

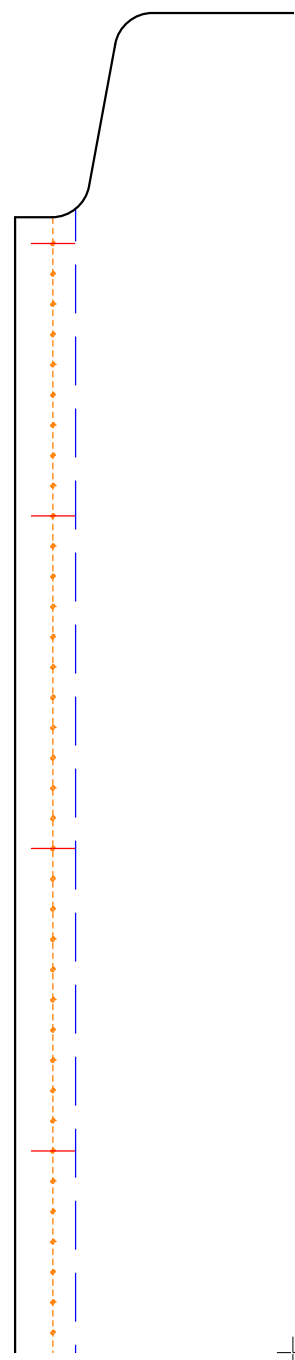
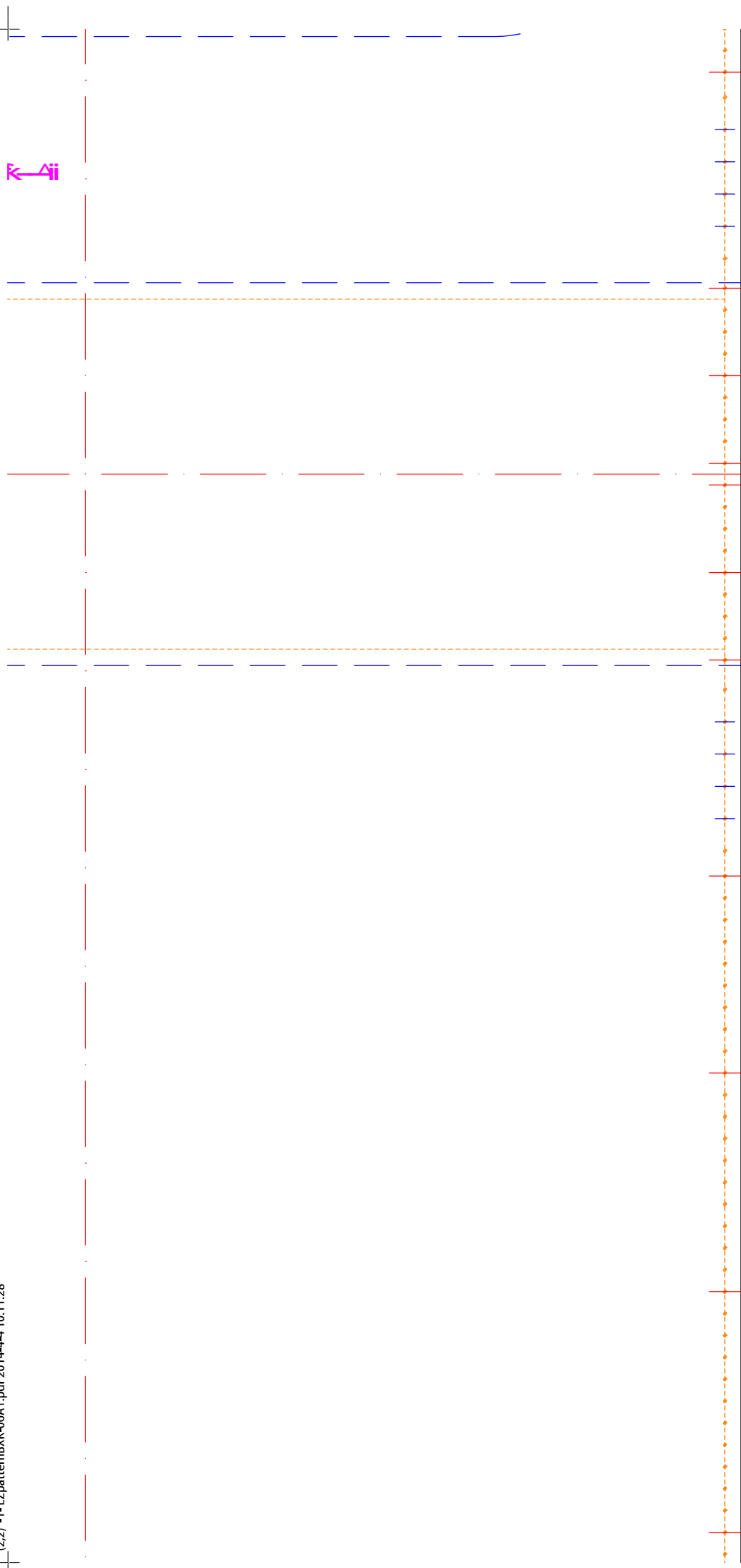

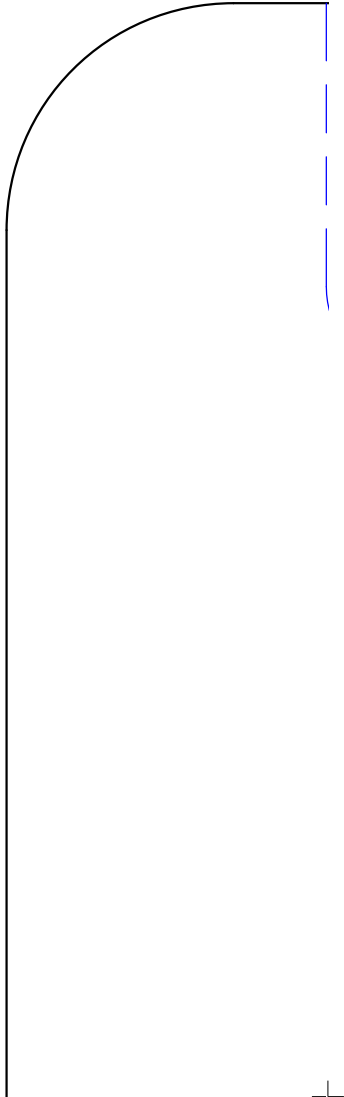
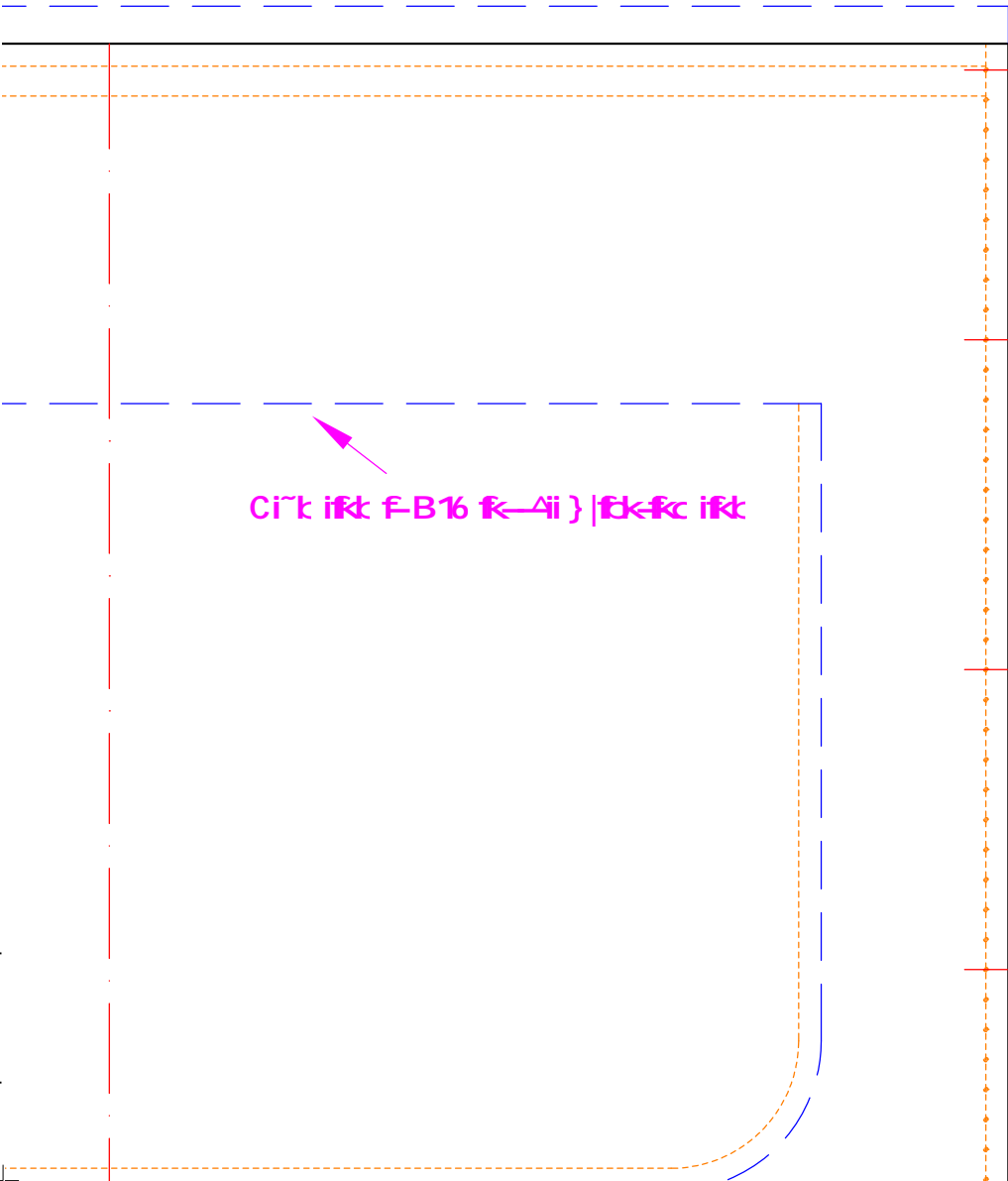

Cirk ikt f-B16 f←Ai } fck-fc ikt

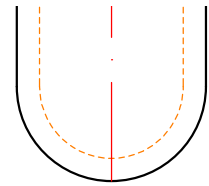
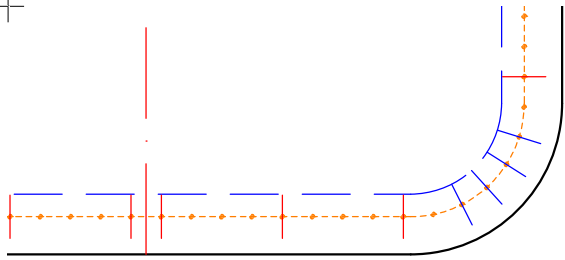

BXK-06 Strap X 2
C02

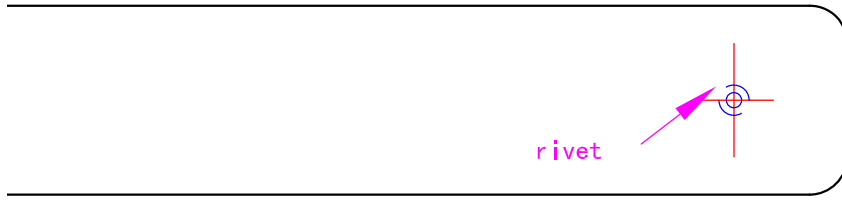
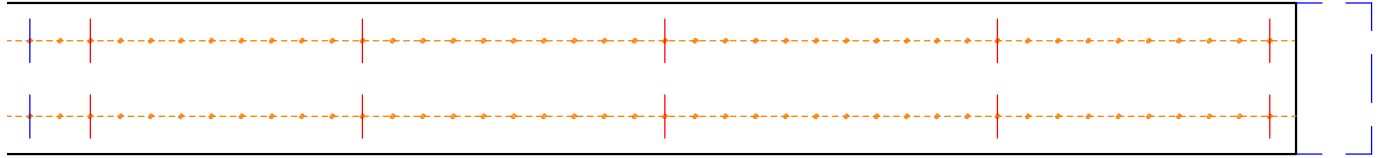

CUL 17C

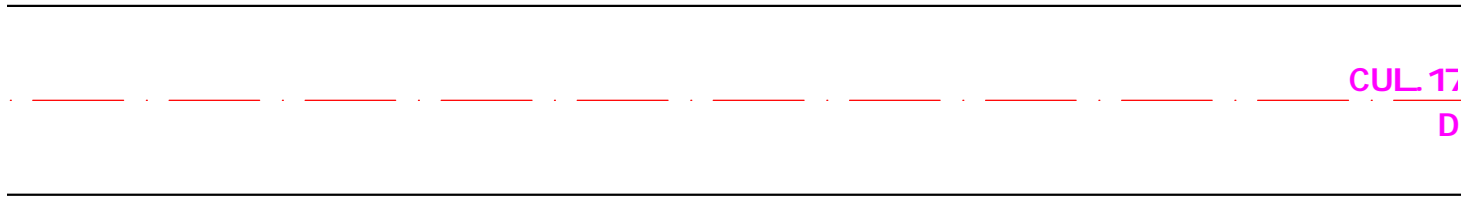

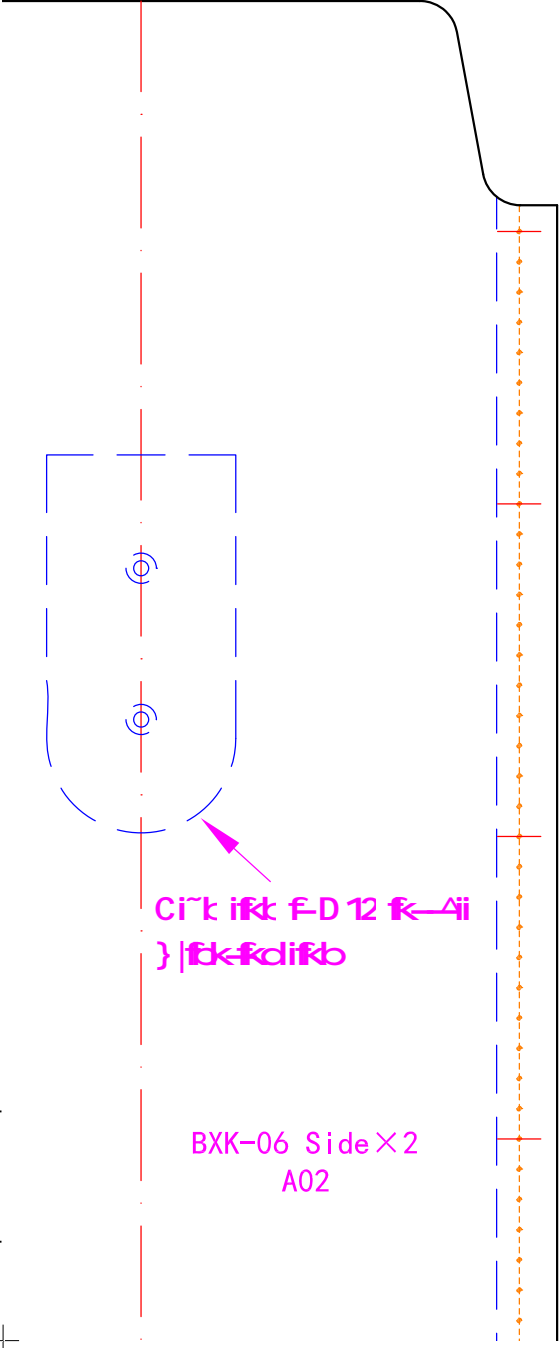
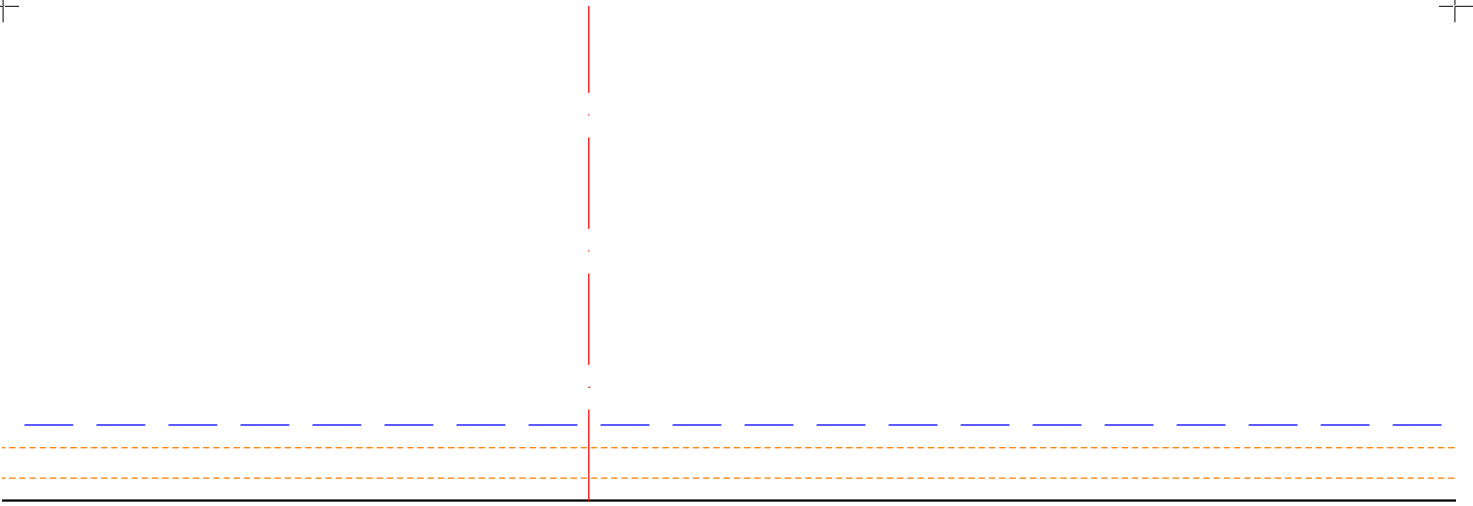

Cirk ikt f-D 12 f-Aii
} | f d i f b

BXK-06 Side X 2
A02

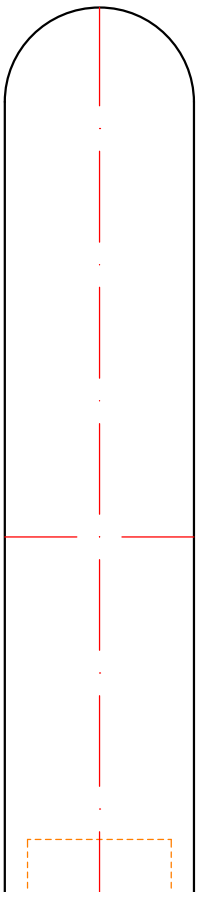
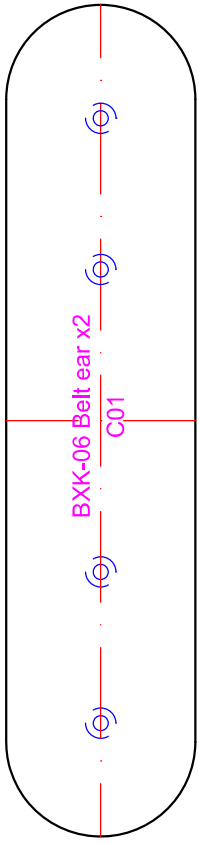

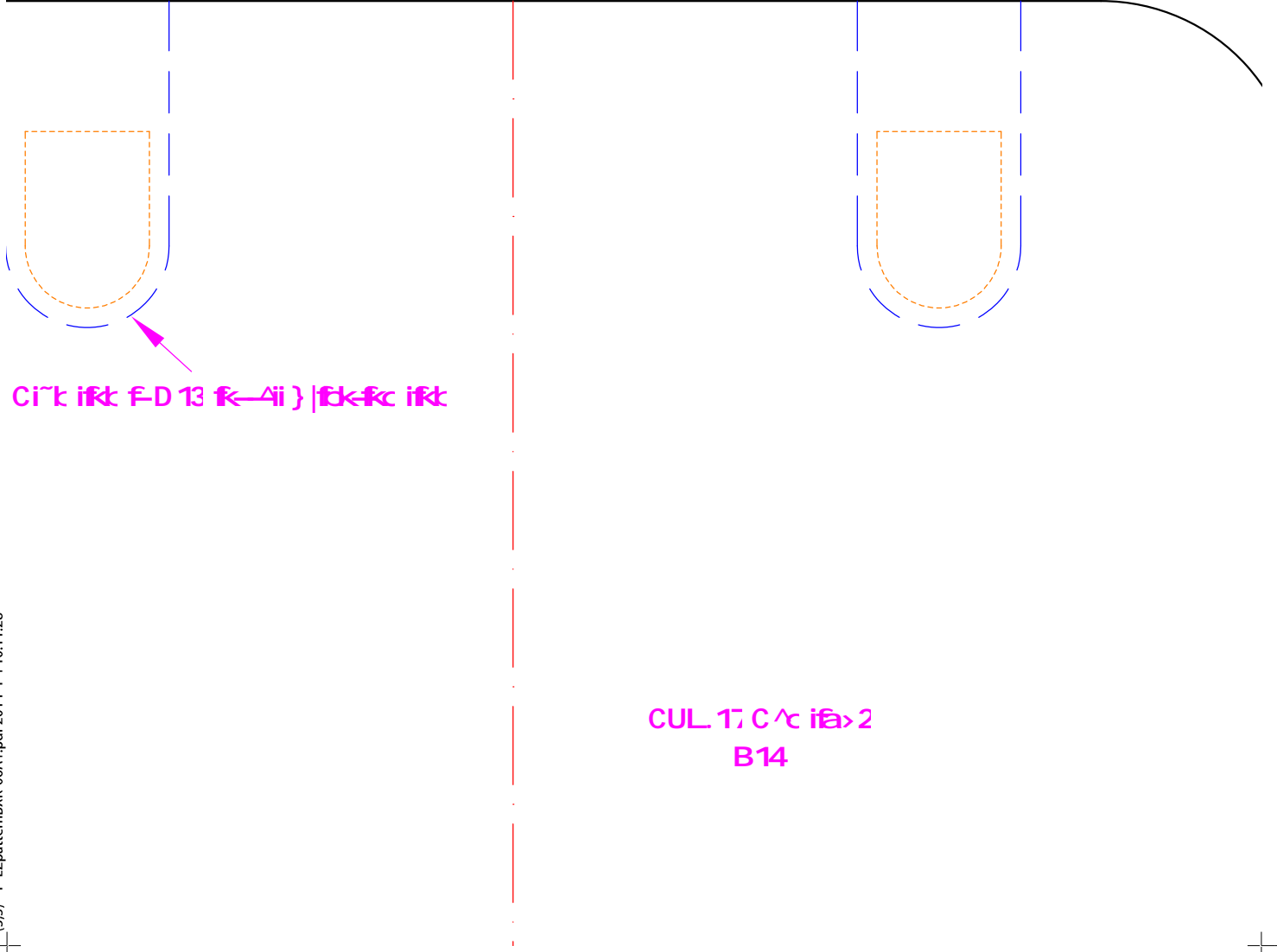

CUL 17 C ^c i f a > 2
B14

CUL 17 C ^c i f a > 2
B14





BXK-06 connection leather X2
C03

0}~} D 14 f` }kkb`bašfe i}`Hb}



Cl

3}bi-|fcd>2 }|>3
D 1:

Clbi-C > 2
1E

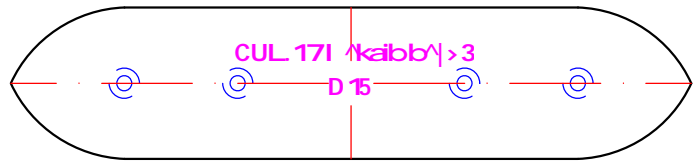
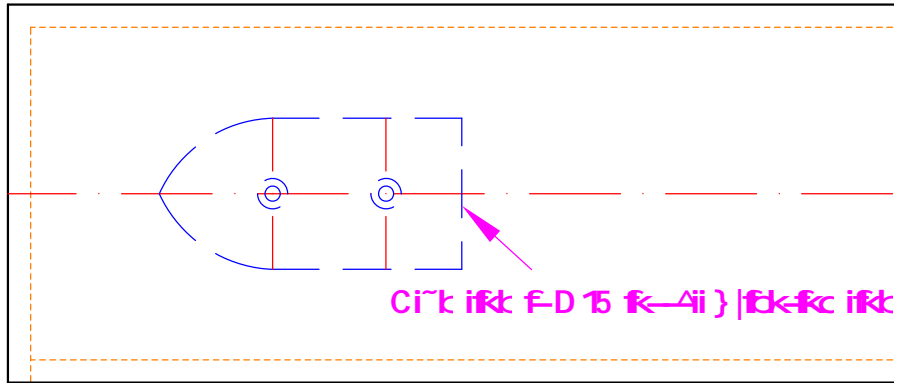
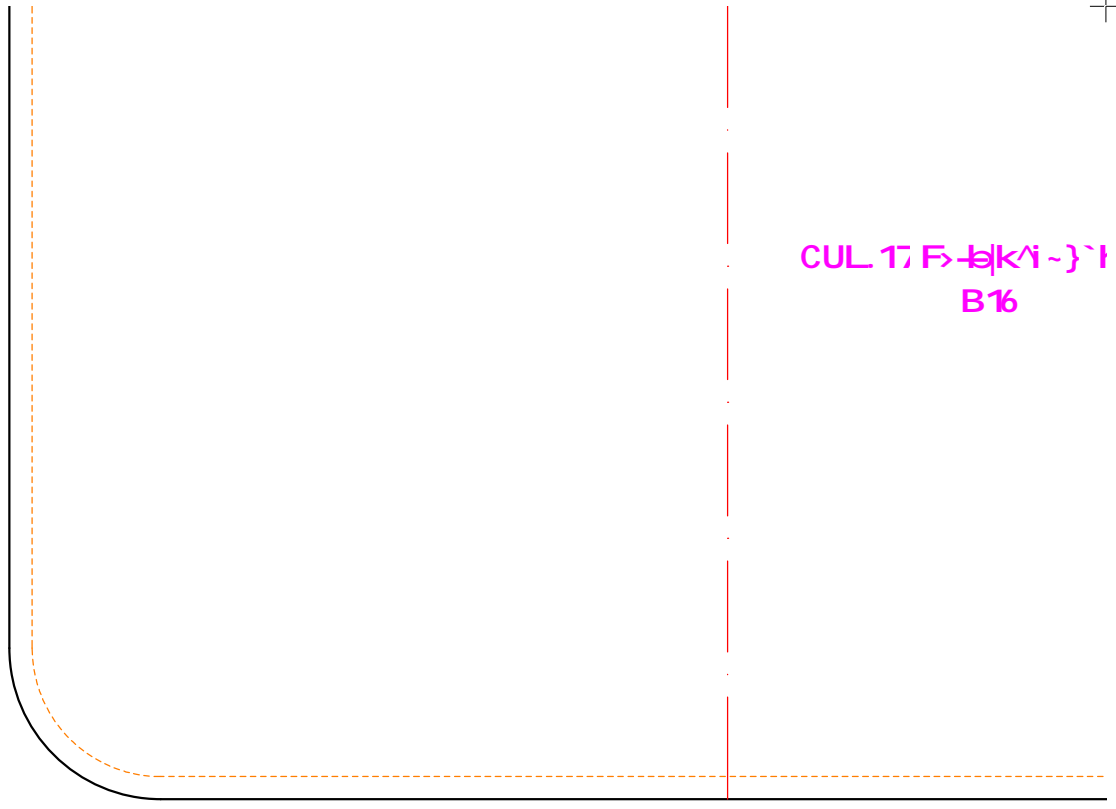
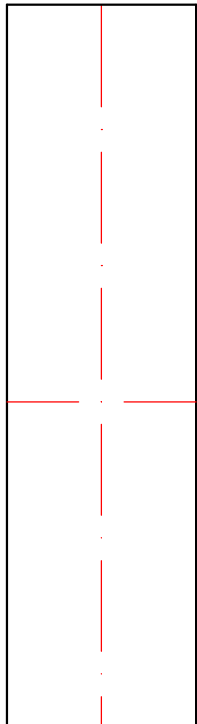

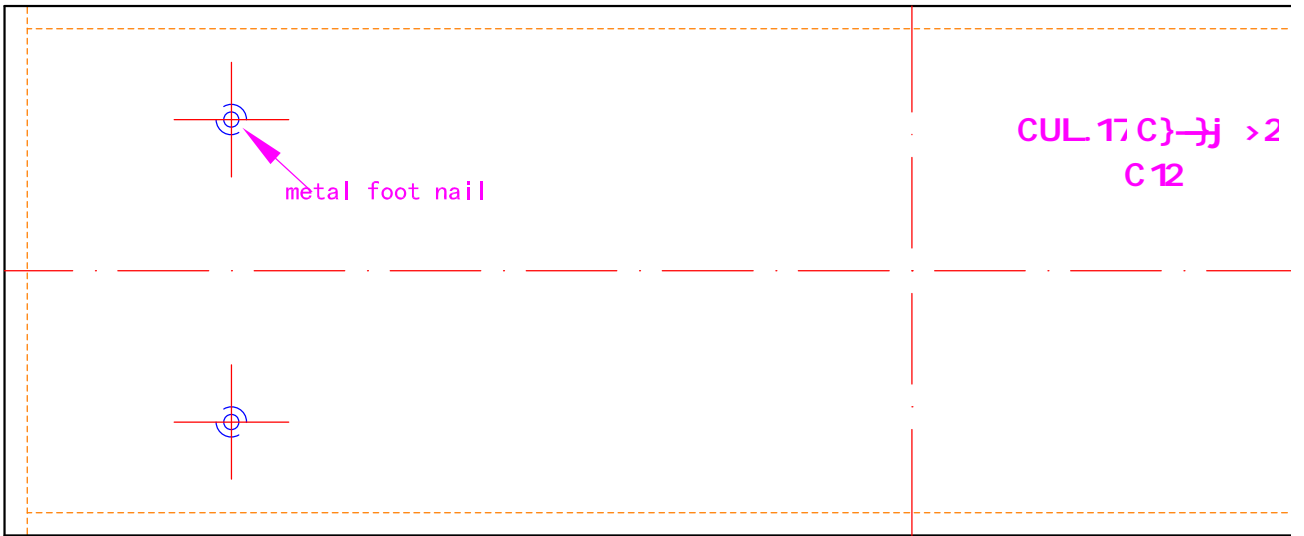

UL 171 $\sqrt{kak} > 2$
D 16

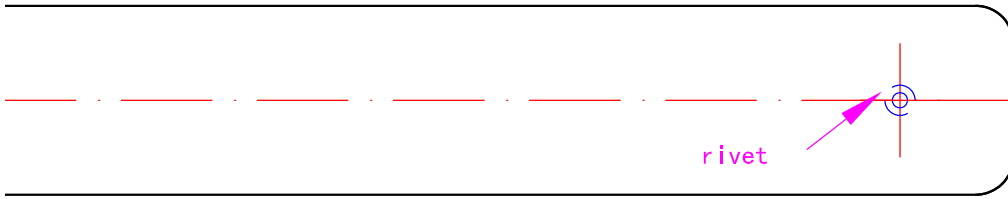

hb>2

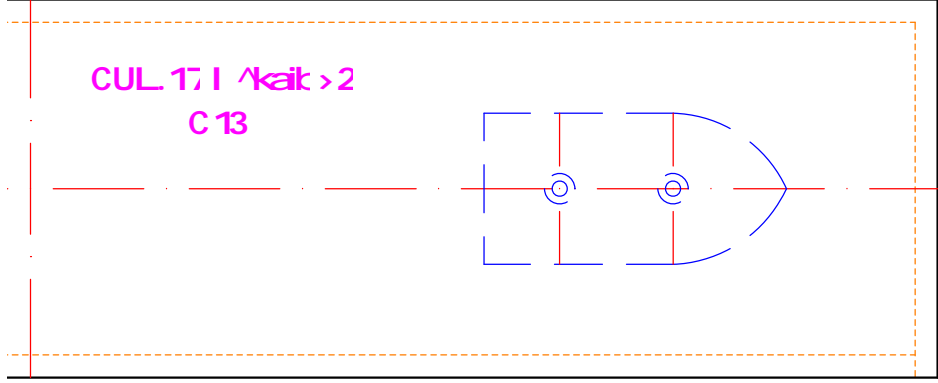
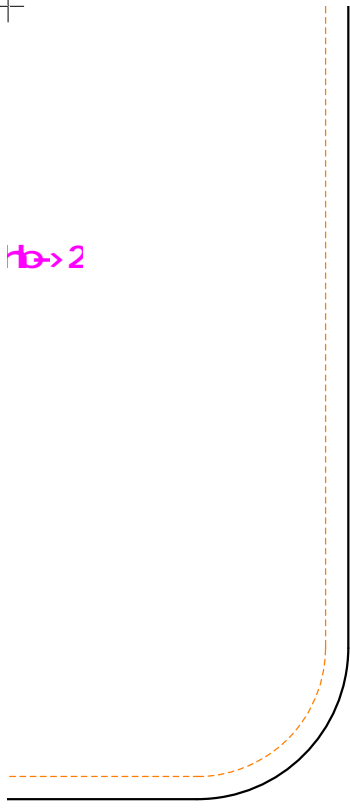

BXK-06

print1:1 A1

