

Заказать выкройку по эскизу или фото
готовые выкройки рюкзаков, сумок, портфелей и т. д.

https://vk.com/mark_nikolai_leather

https://boosty.to/mark_nikolai

а 1.1

задняя стенка

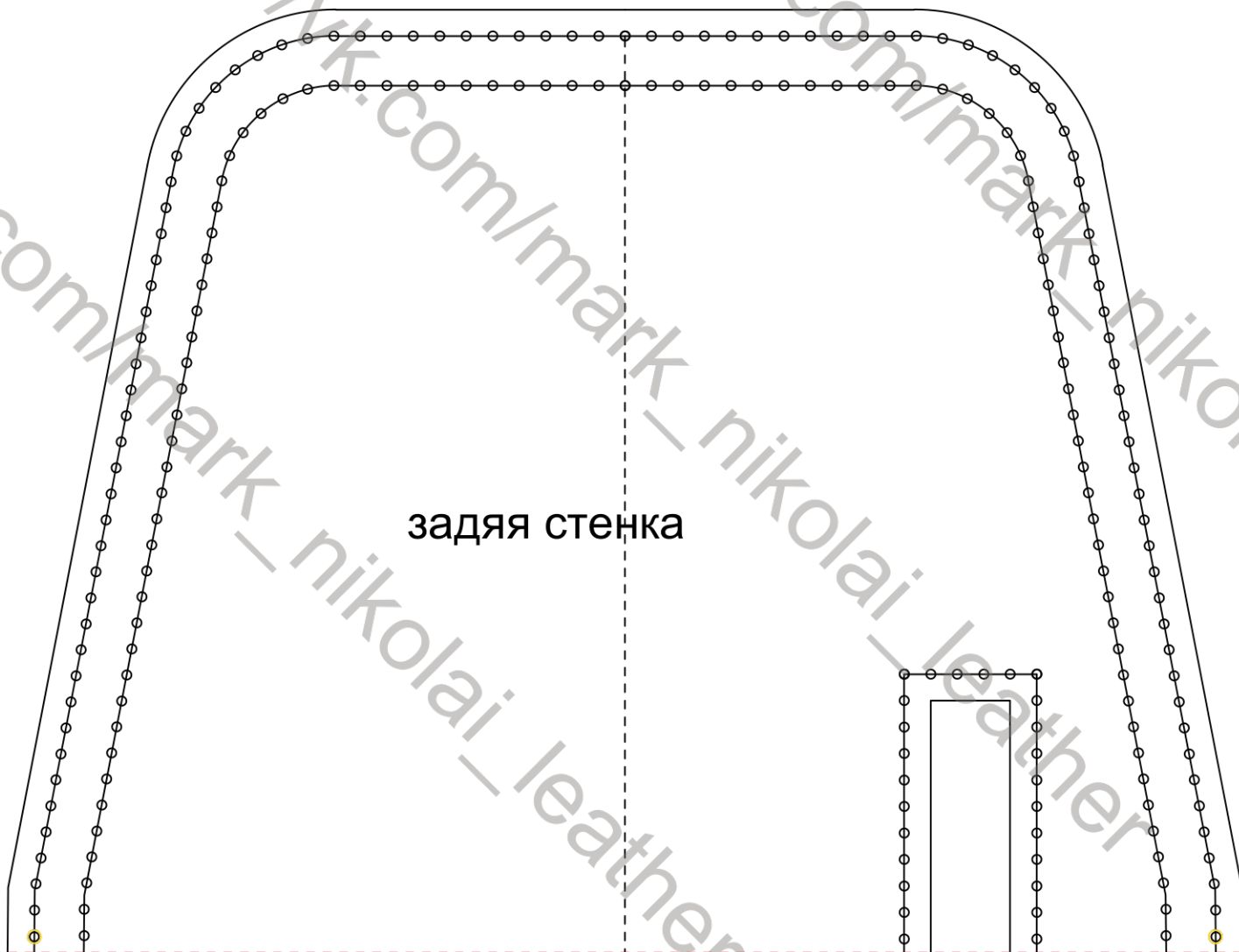

a 2.1

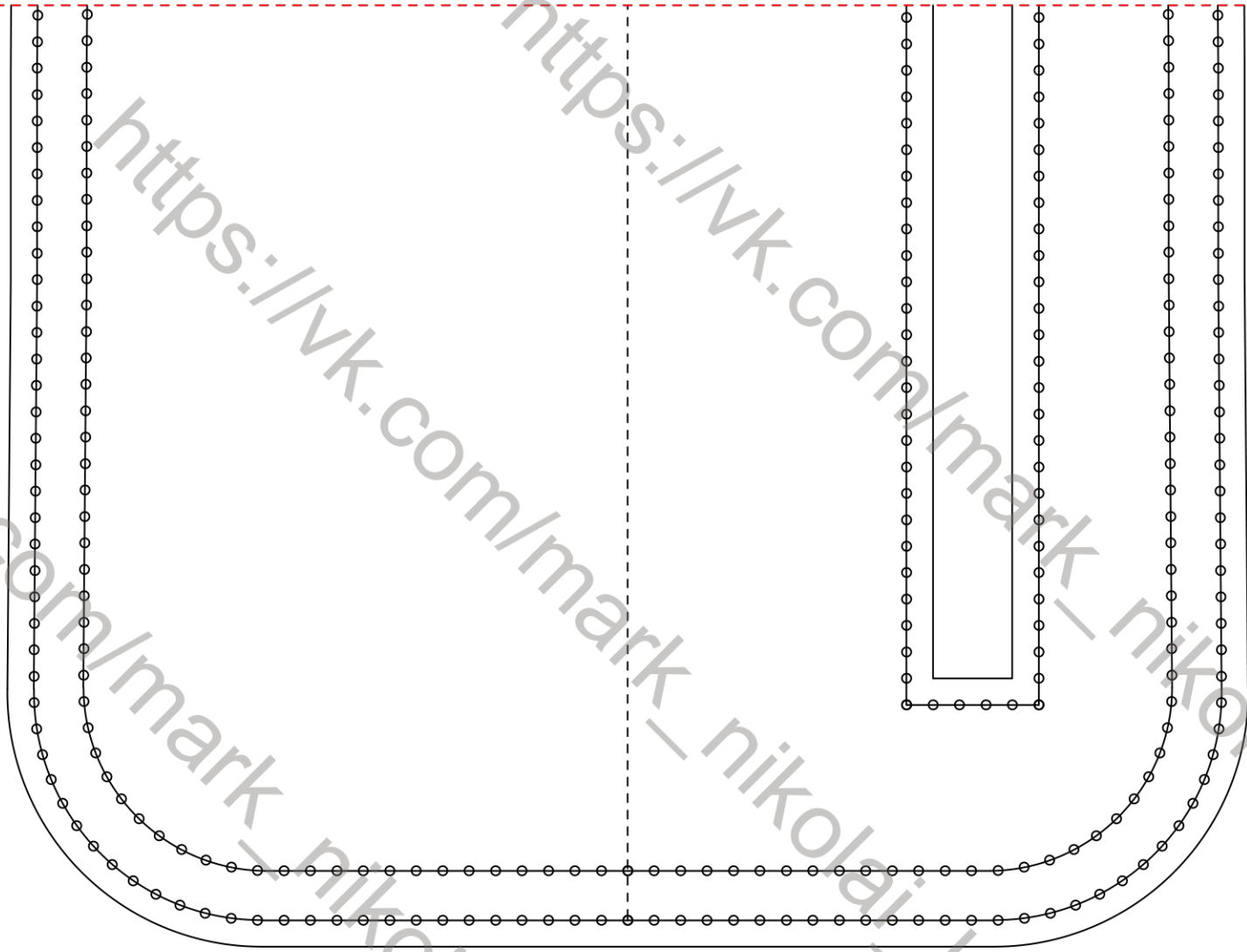

https://vk.com/mark_nikolai_leather

б

усилитель на заднюю стенку



b1

передняя стенка

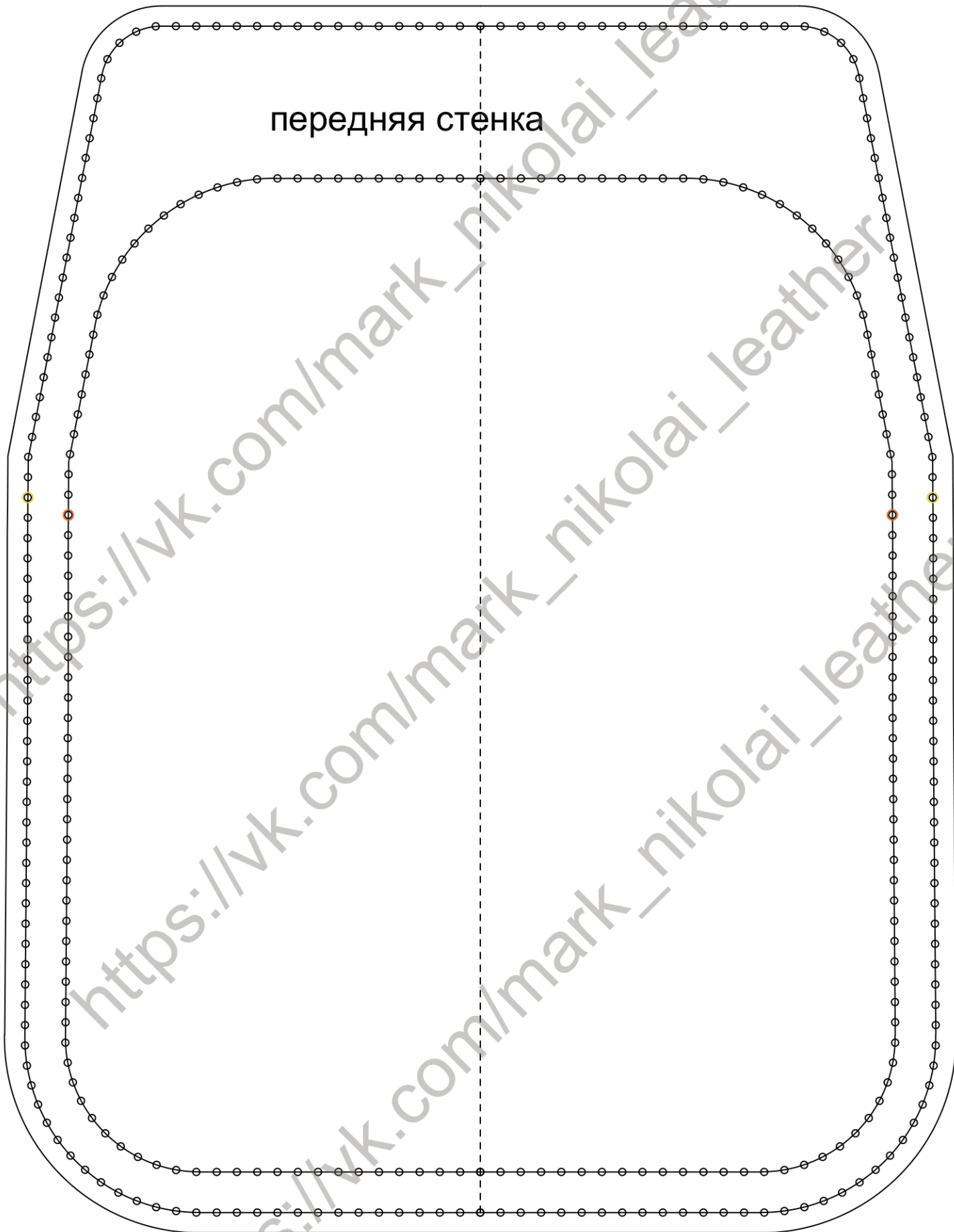

b2



b3

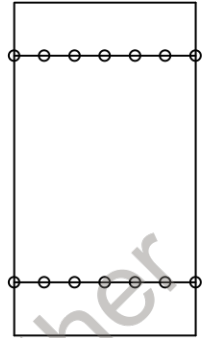
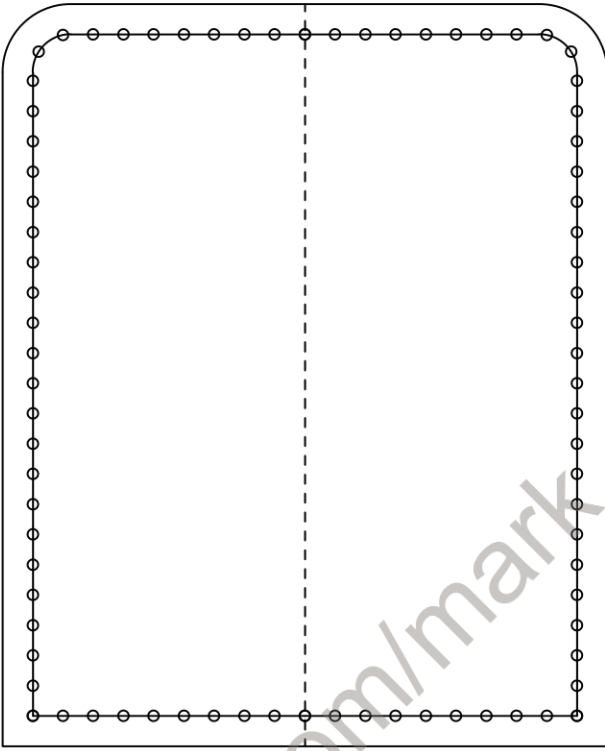

карман на стенку переднего отдела

b4

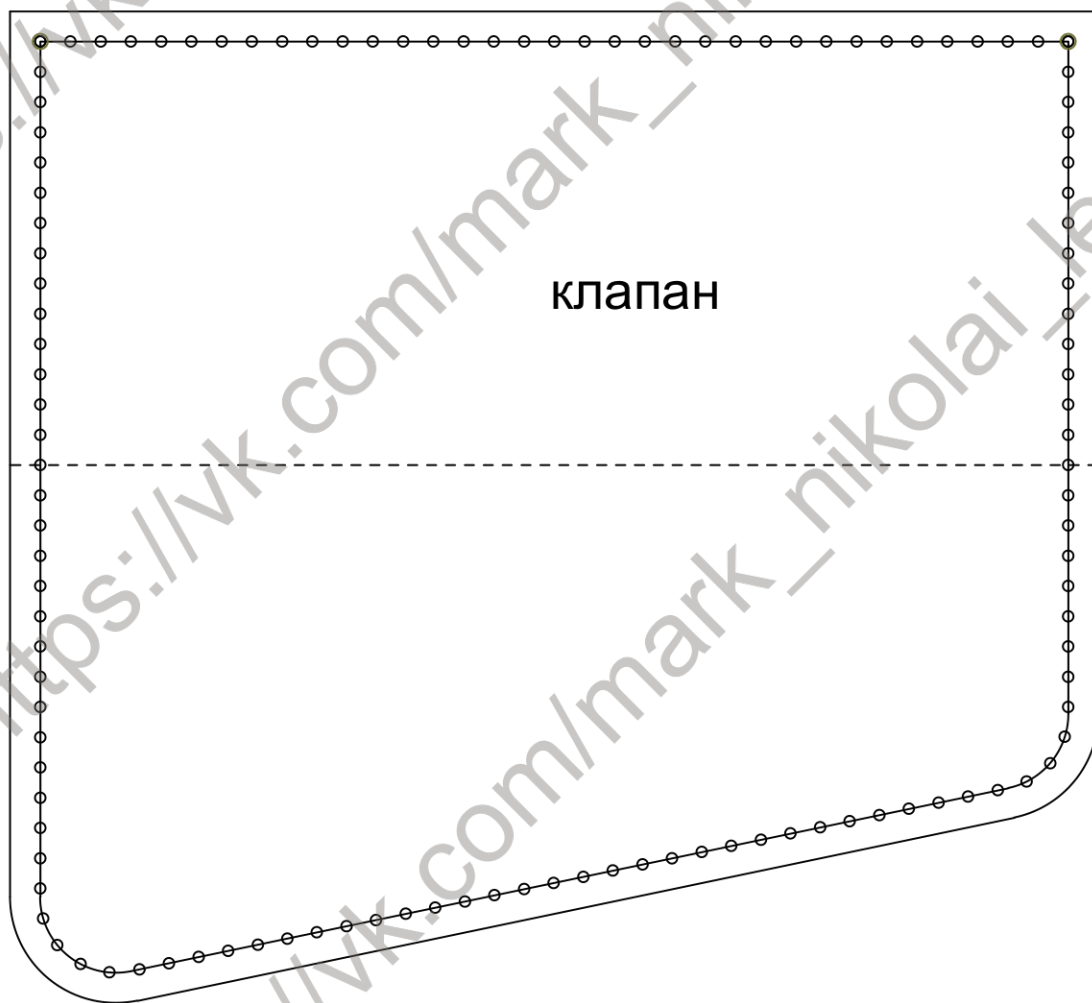
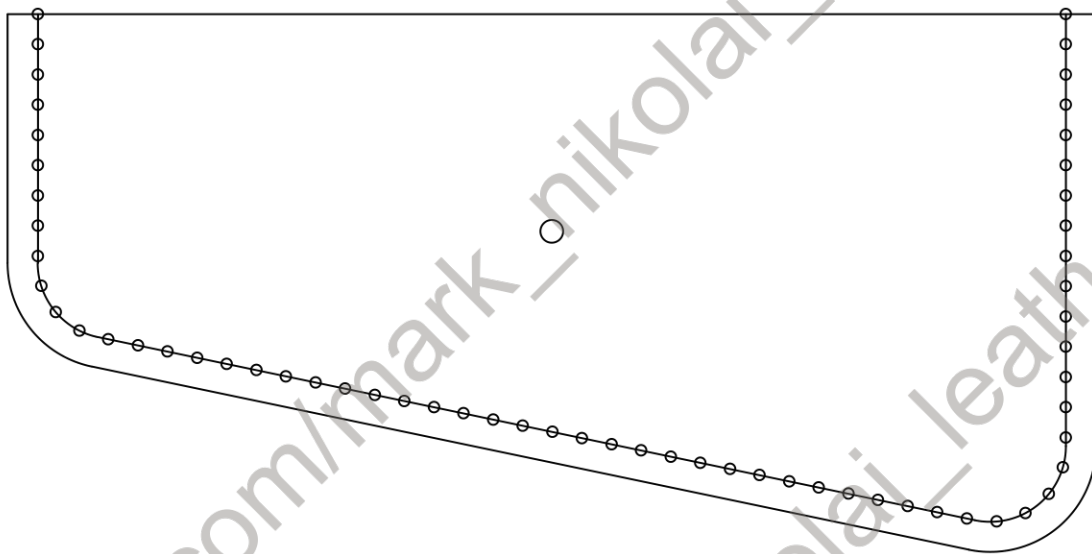

с 1.1

ботан верх

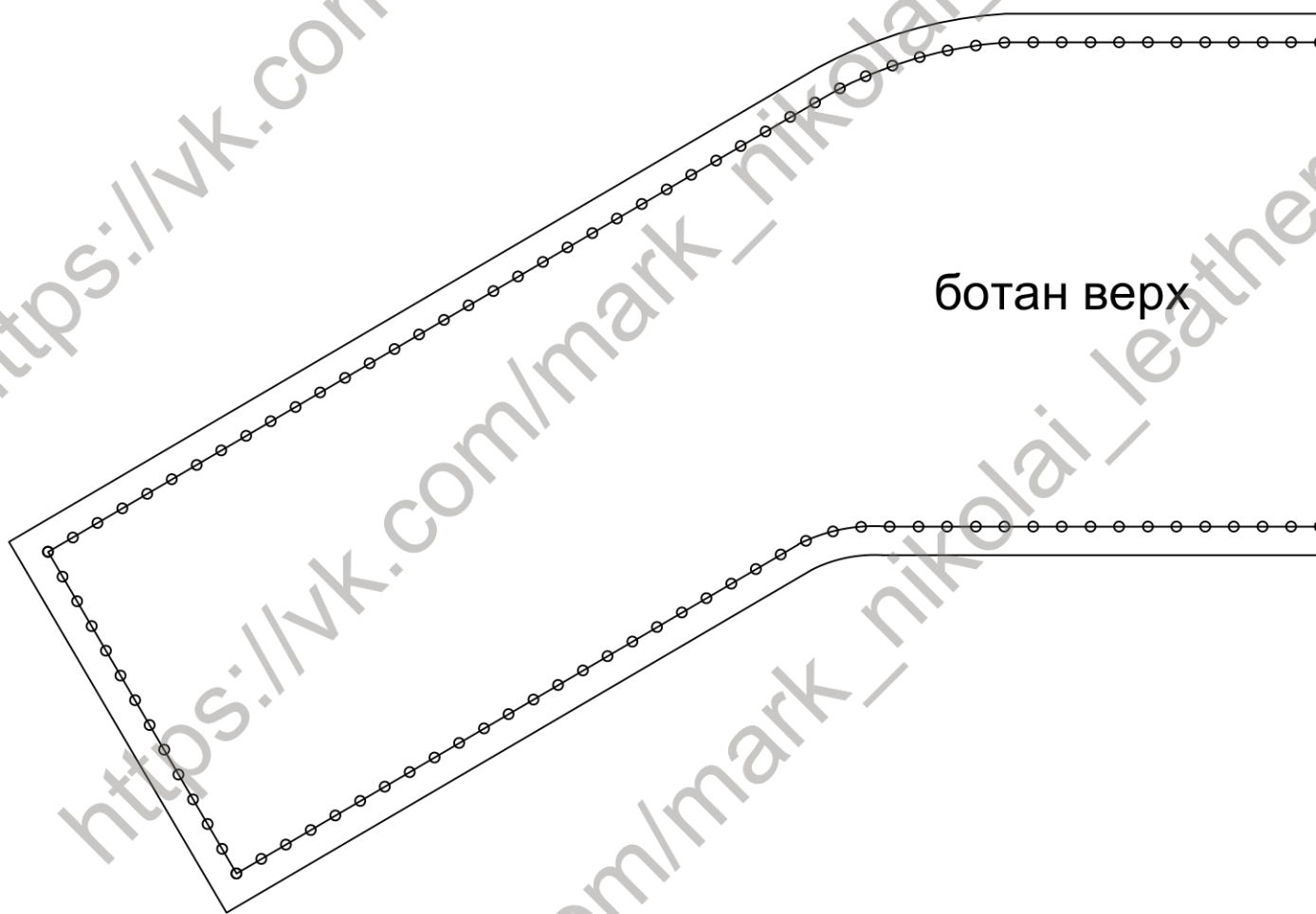

c 1.2

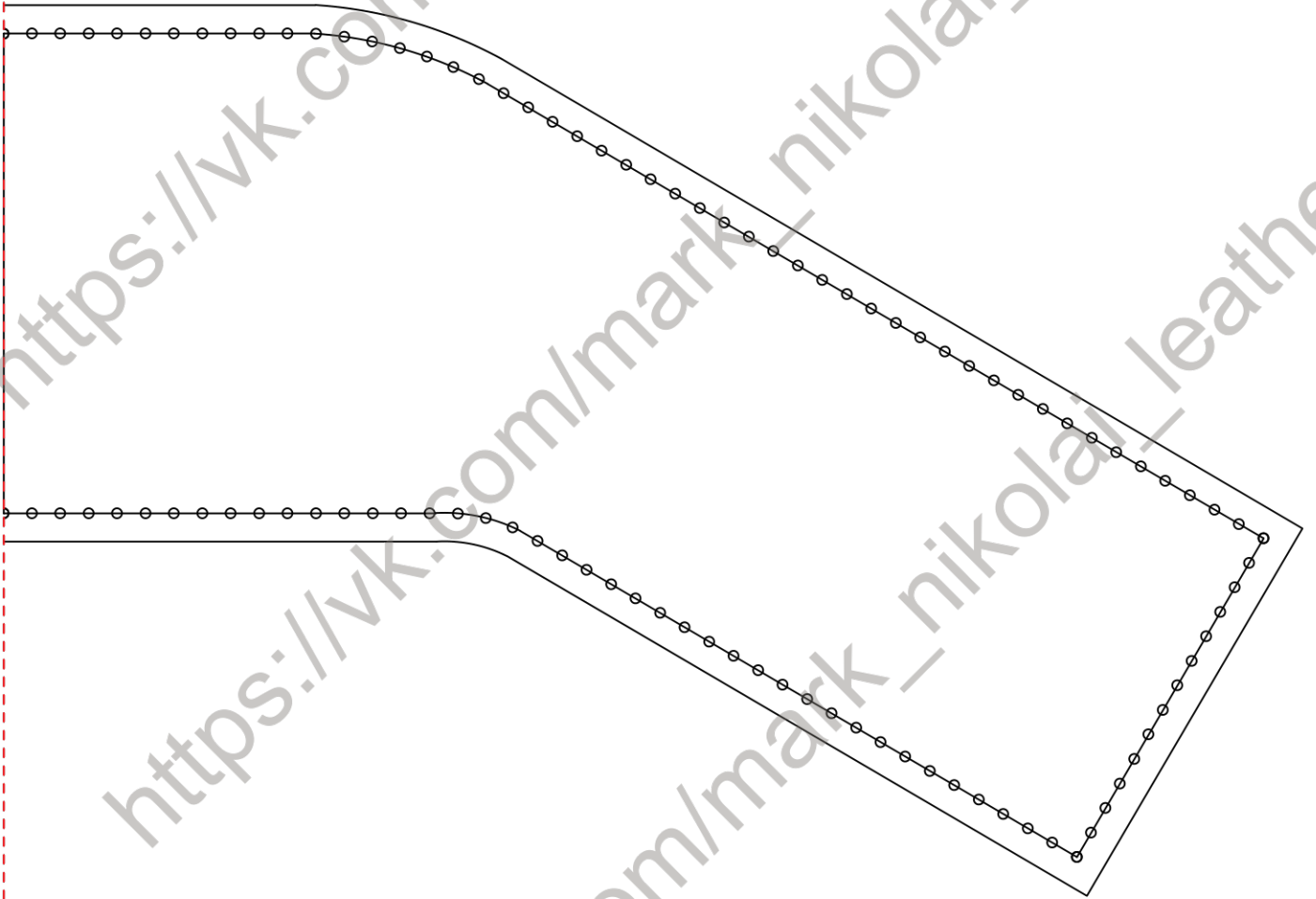

d 1.1

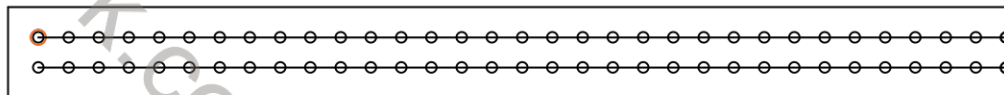

d 1.2

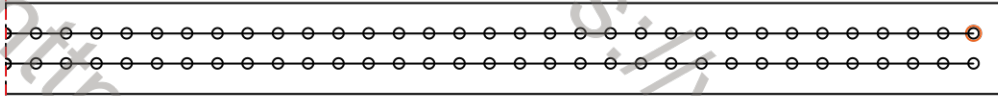

ботан малого отдела

