

Фурнитура:  
две пряжки 38 мм.  
Молния пятерка по размеру.

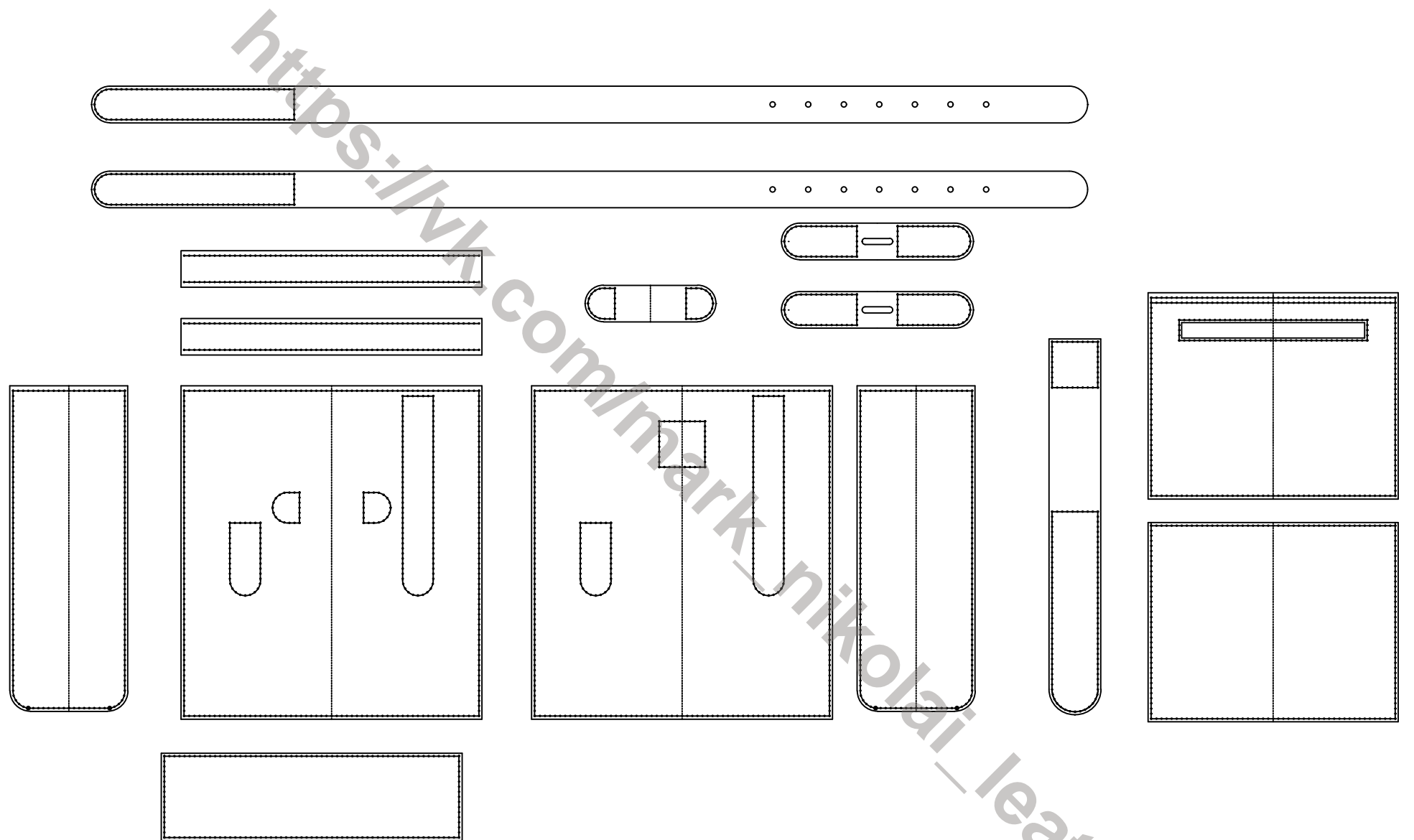

[https://vk.com/mark\\_nikolai\\_leather](https://vk.com/mark_nikolai_leather)

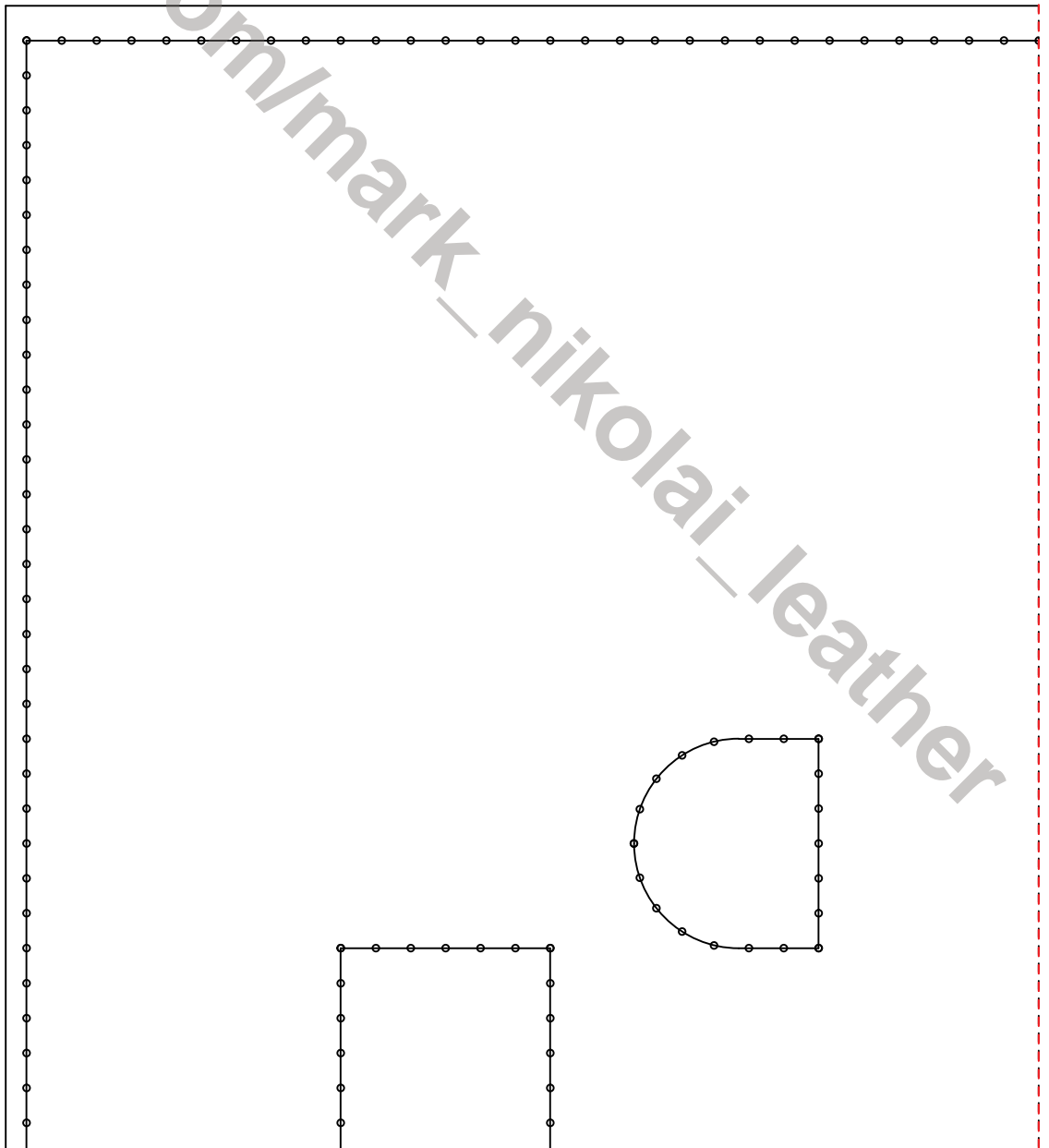

[https://vk.com/mark\\_nikolai\\_leather](https://vk.com/mark_nikolai_leather)

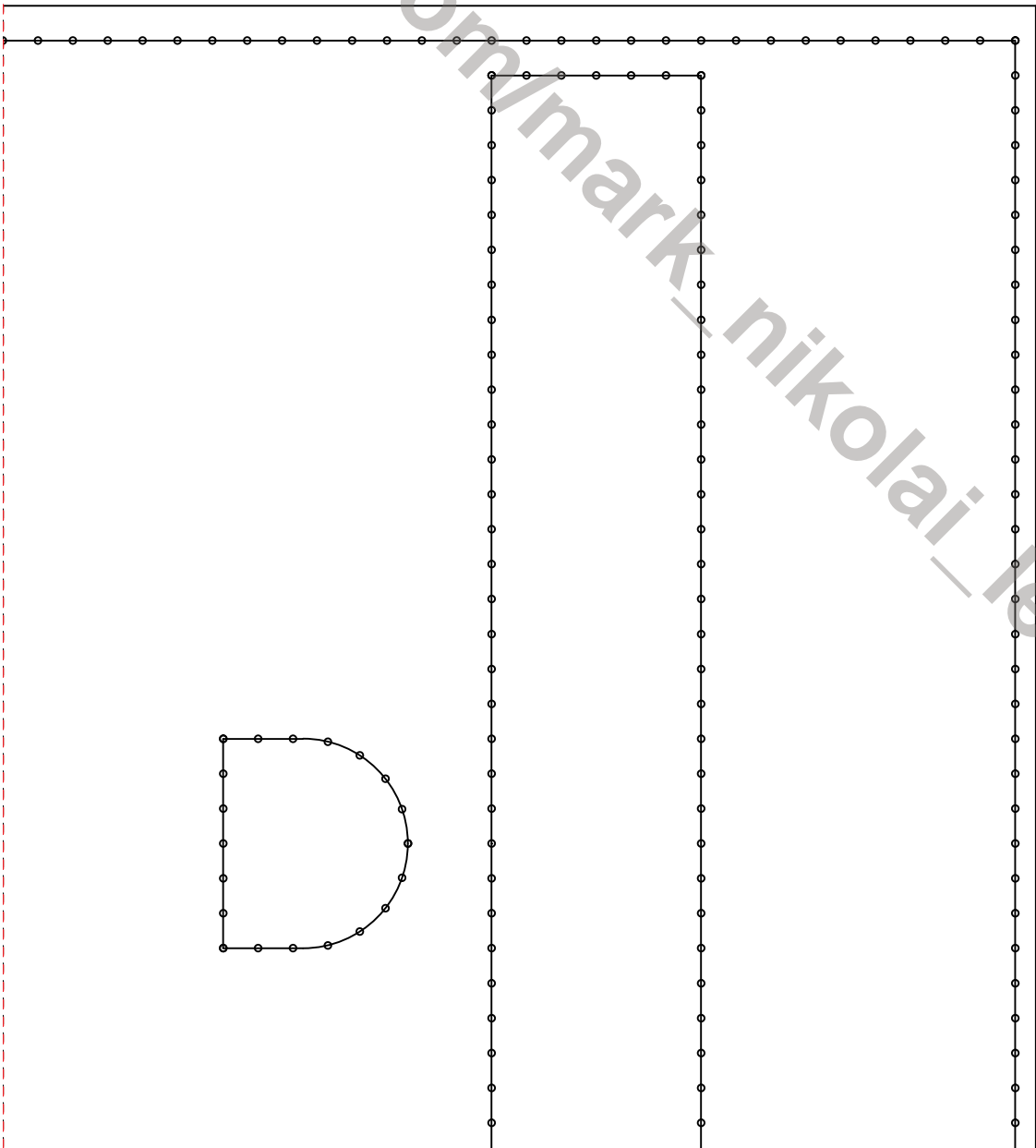

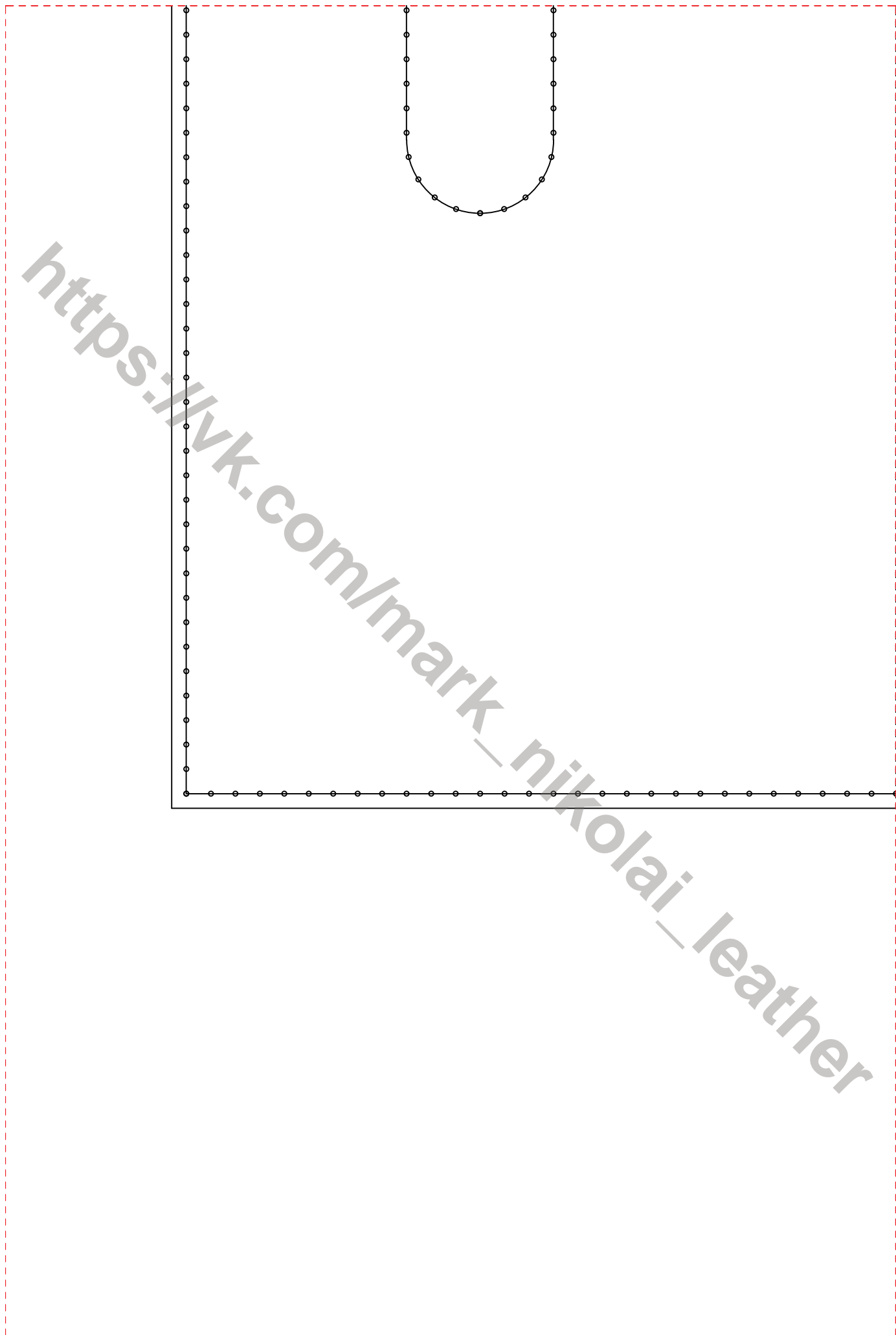

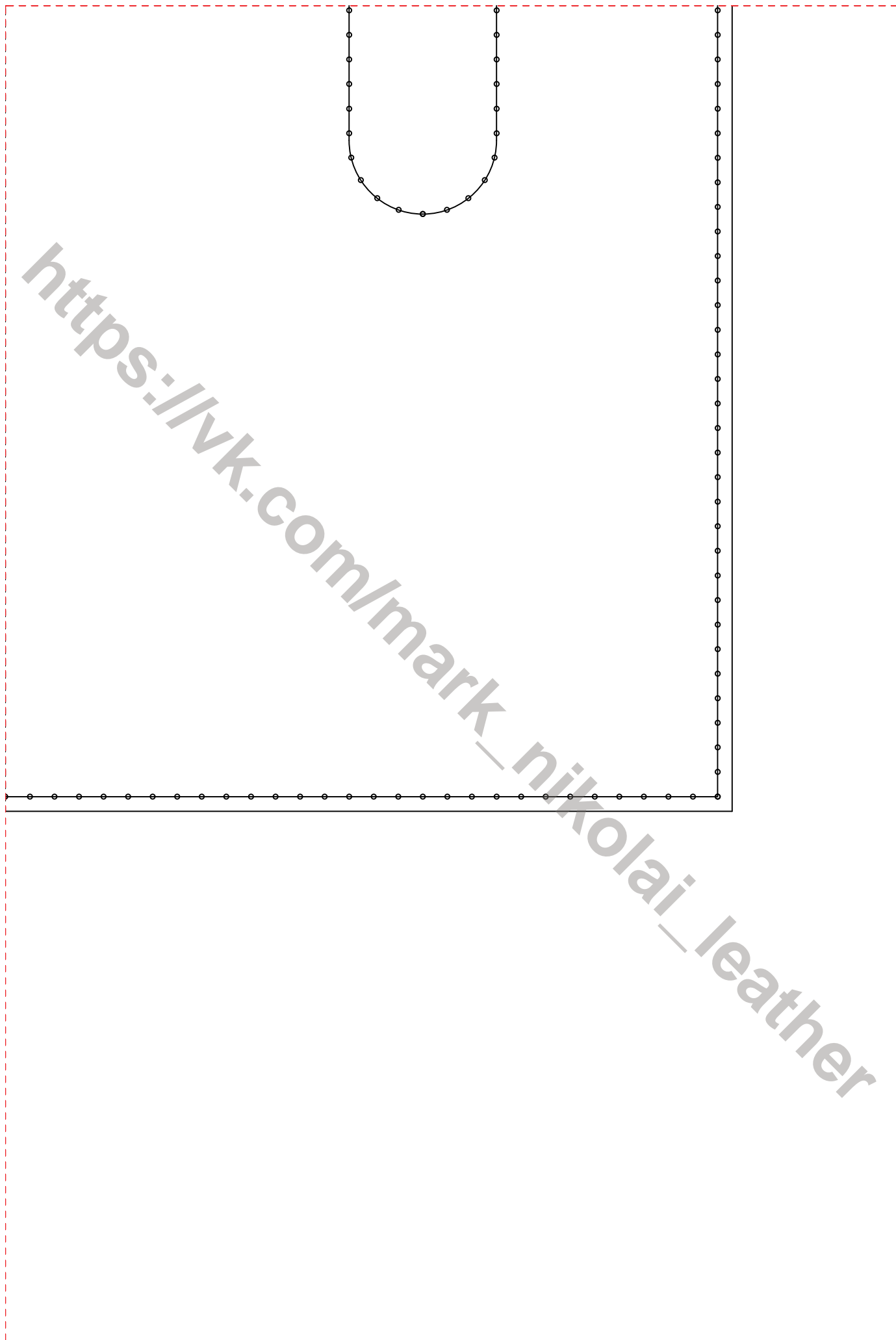

[https://vk.com/mark\\_nikolai\\_leather](https://vk.com/mark_nikolai_leather)

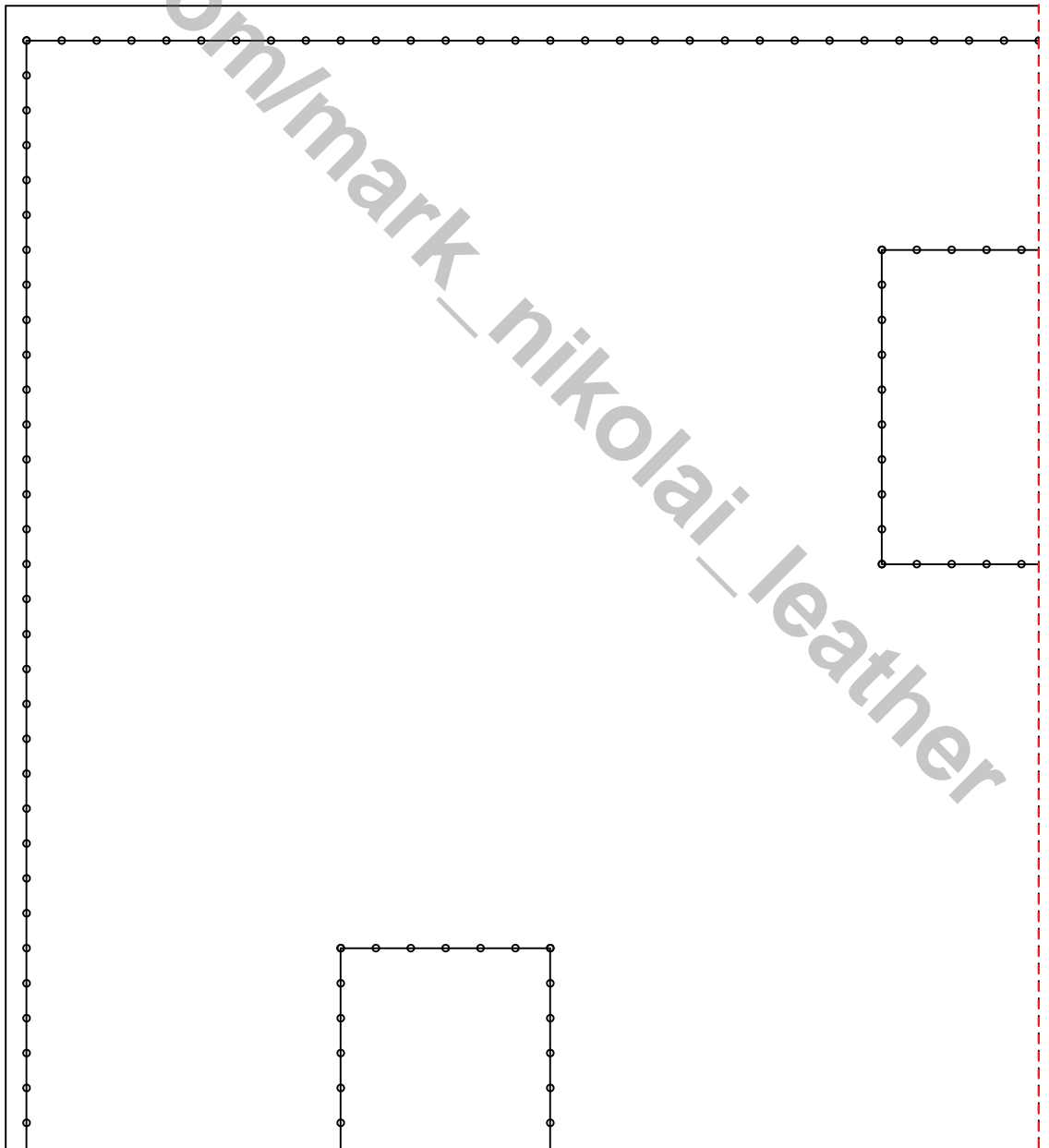

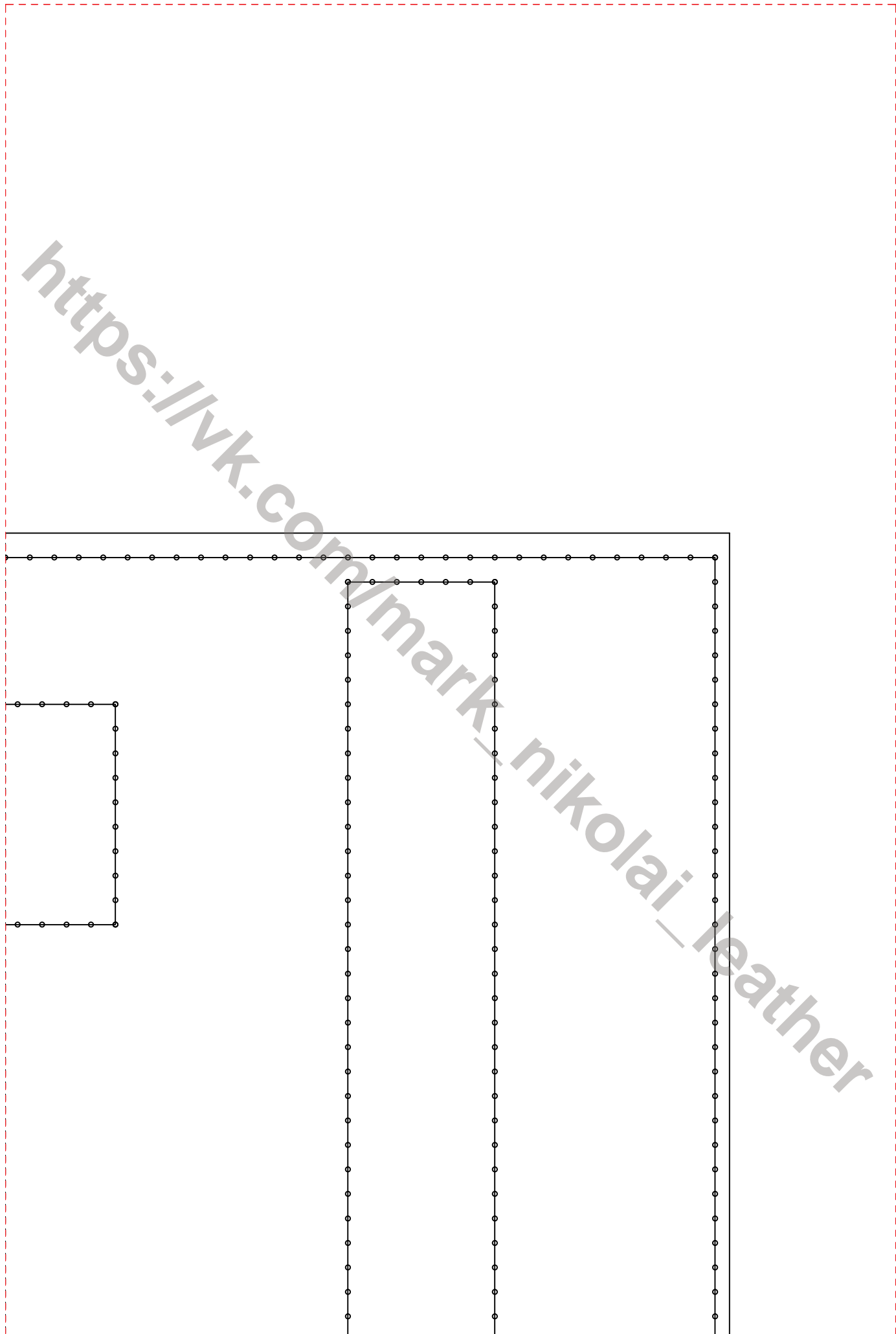



[https://vk.com/mark\\_nikolai\\_leather](https://vk.com/mark_nikolai_leather)

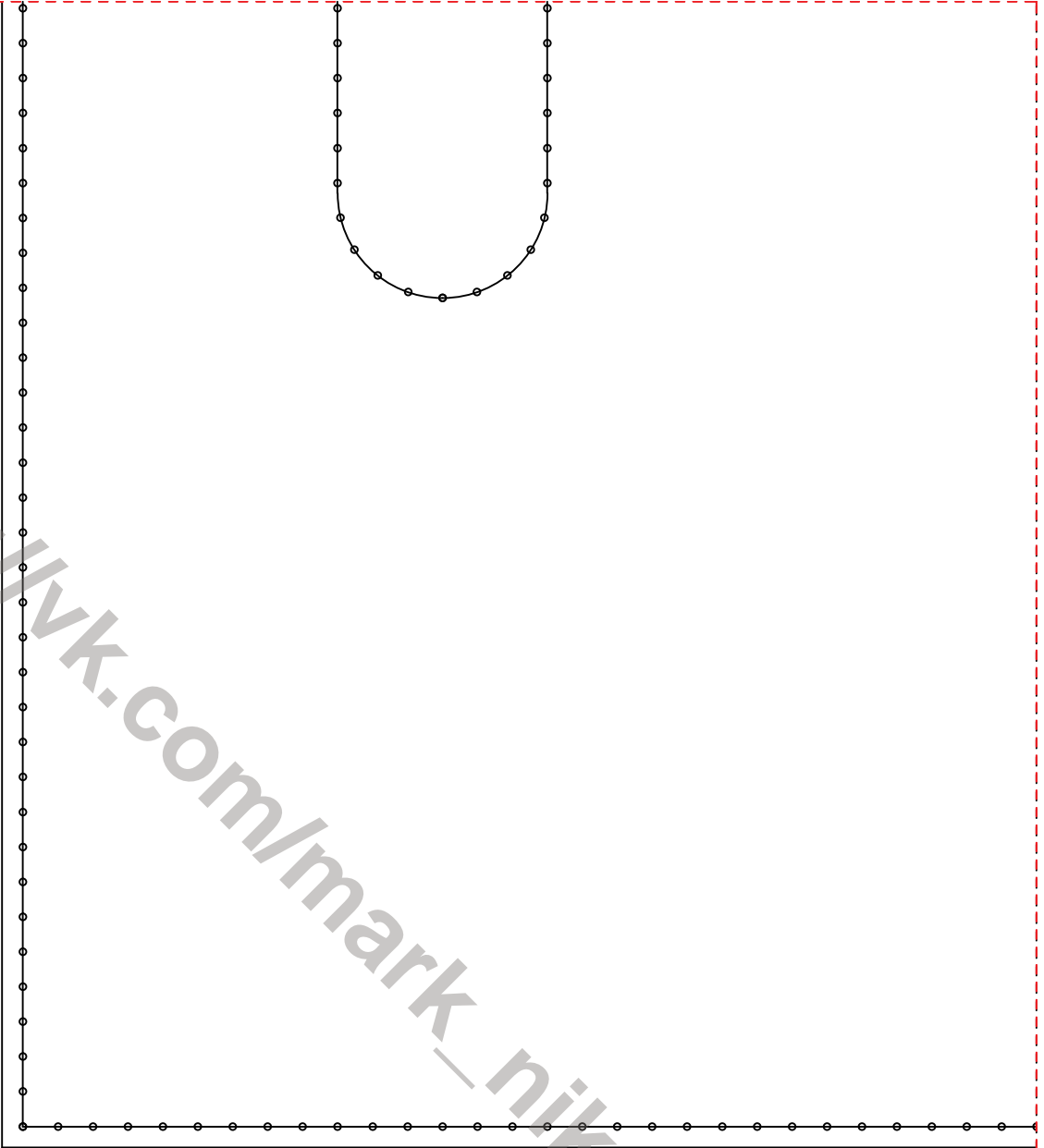

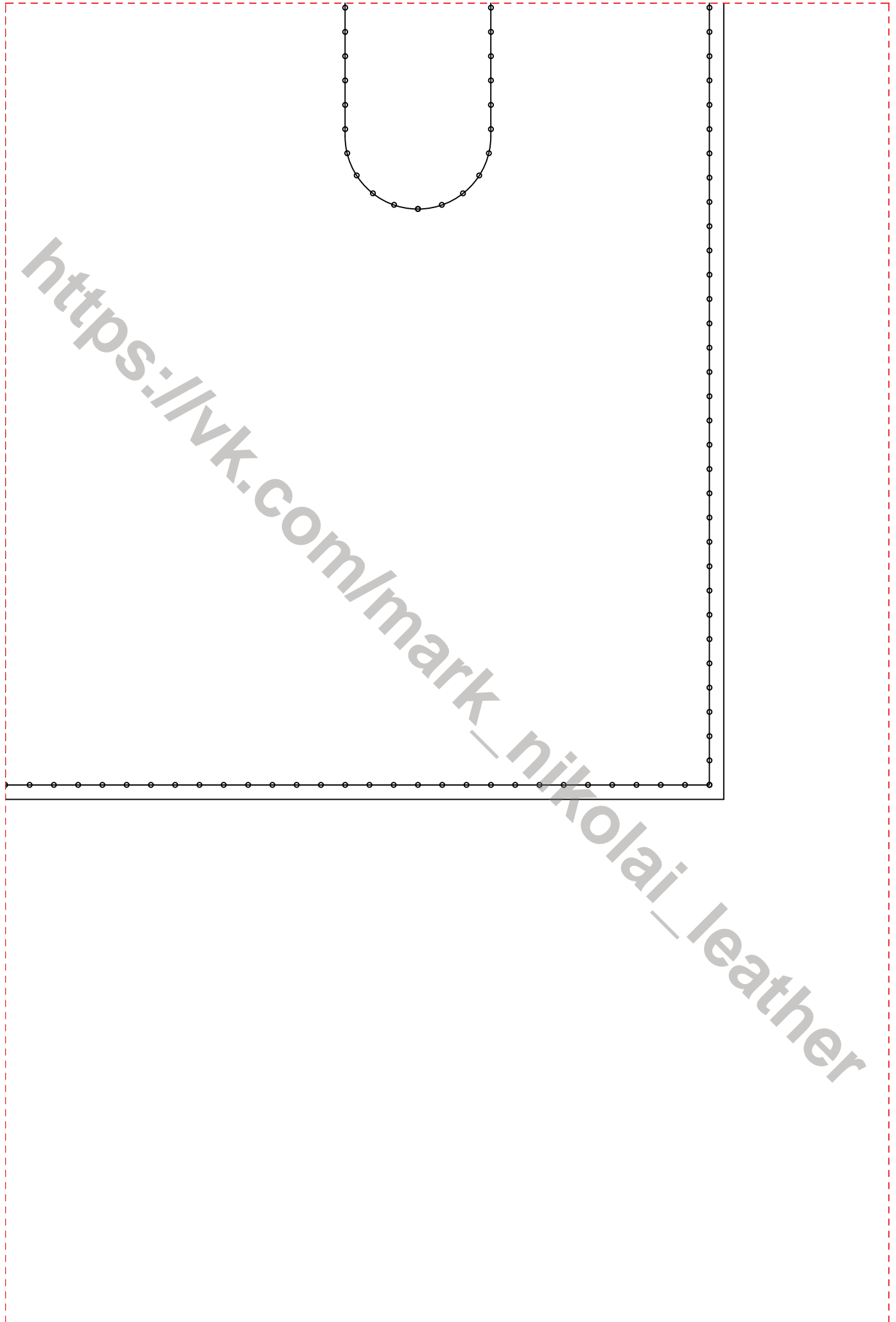

[https://vk.com/mark\\_nikolai\\_leather](https://vk.com/mark_nikolai_leather)

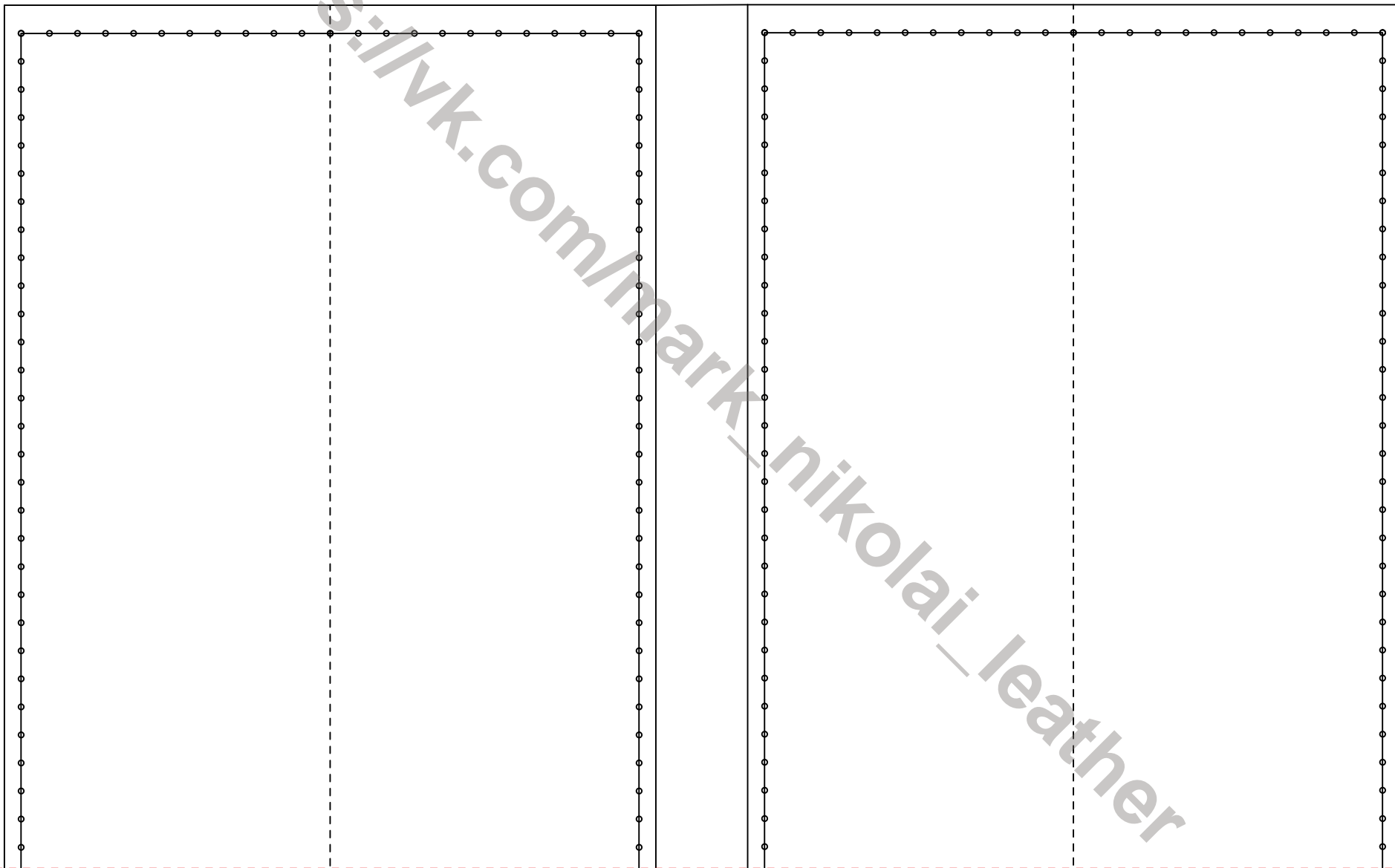

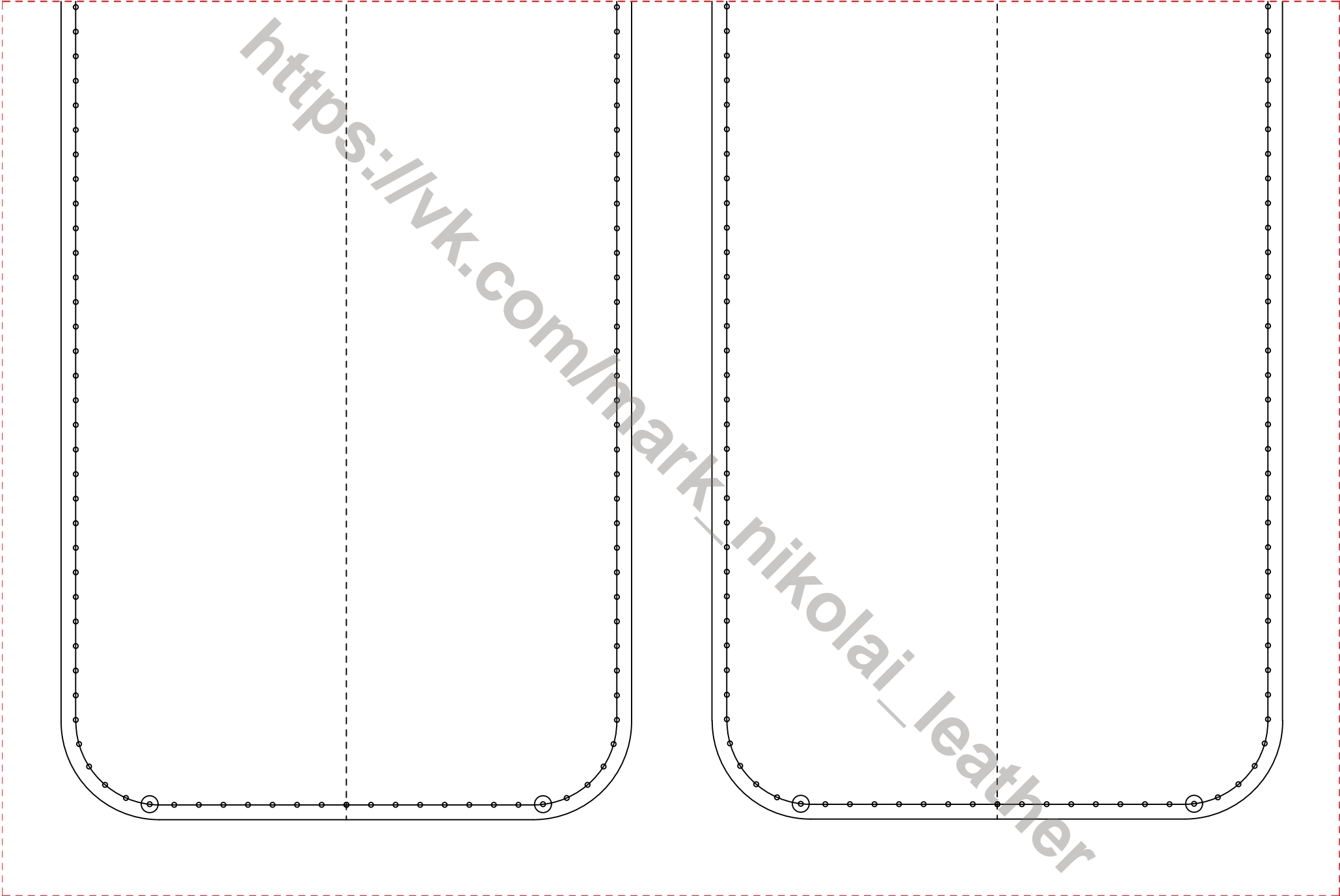

[https://vk.com/mark\\_nikolai\\_leather](https://vk.com/mark_nikolai_leather)

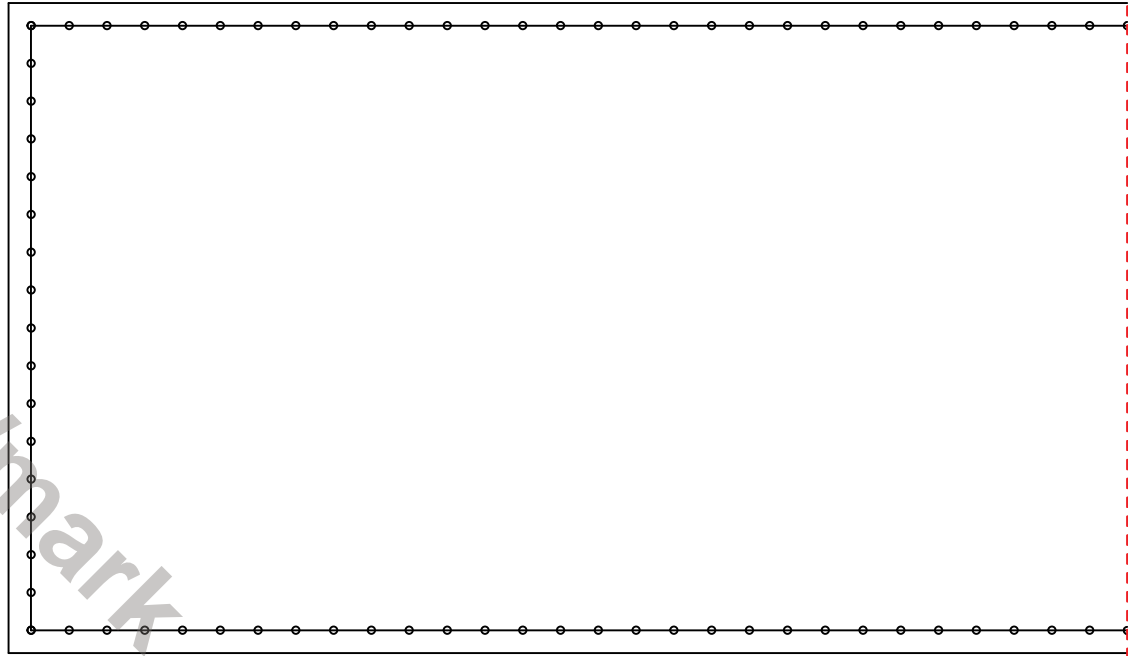
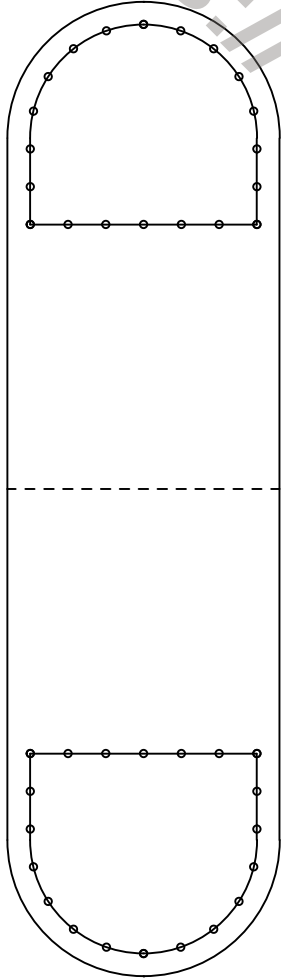

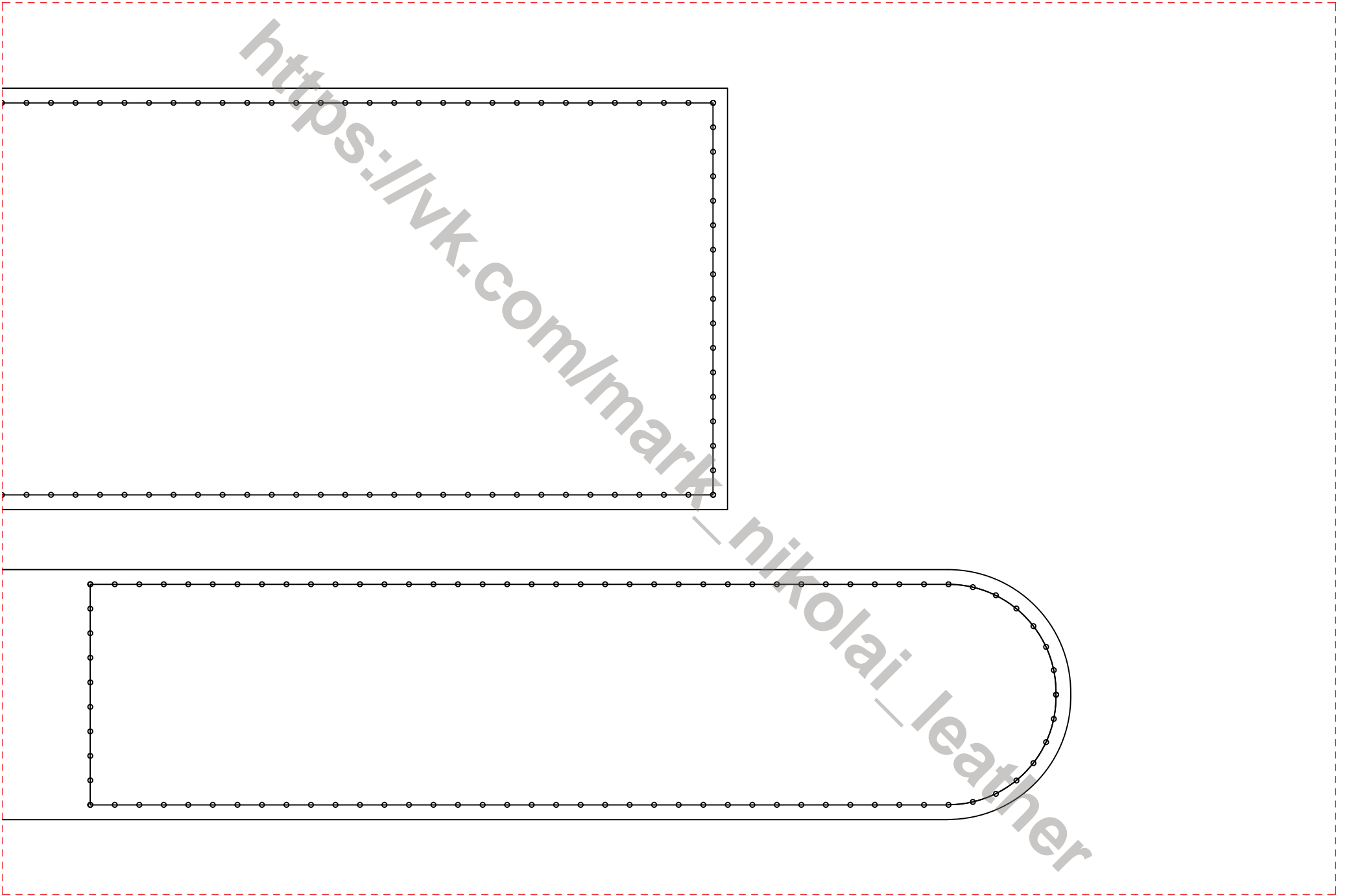

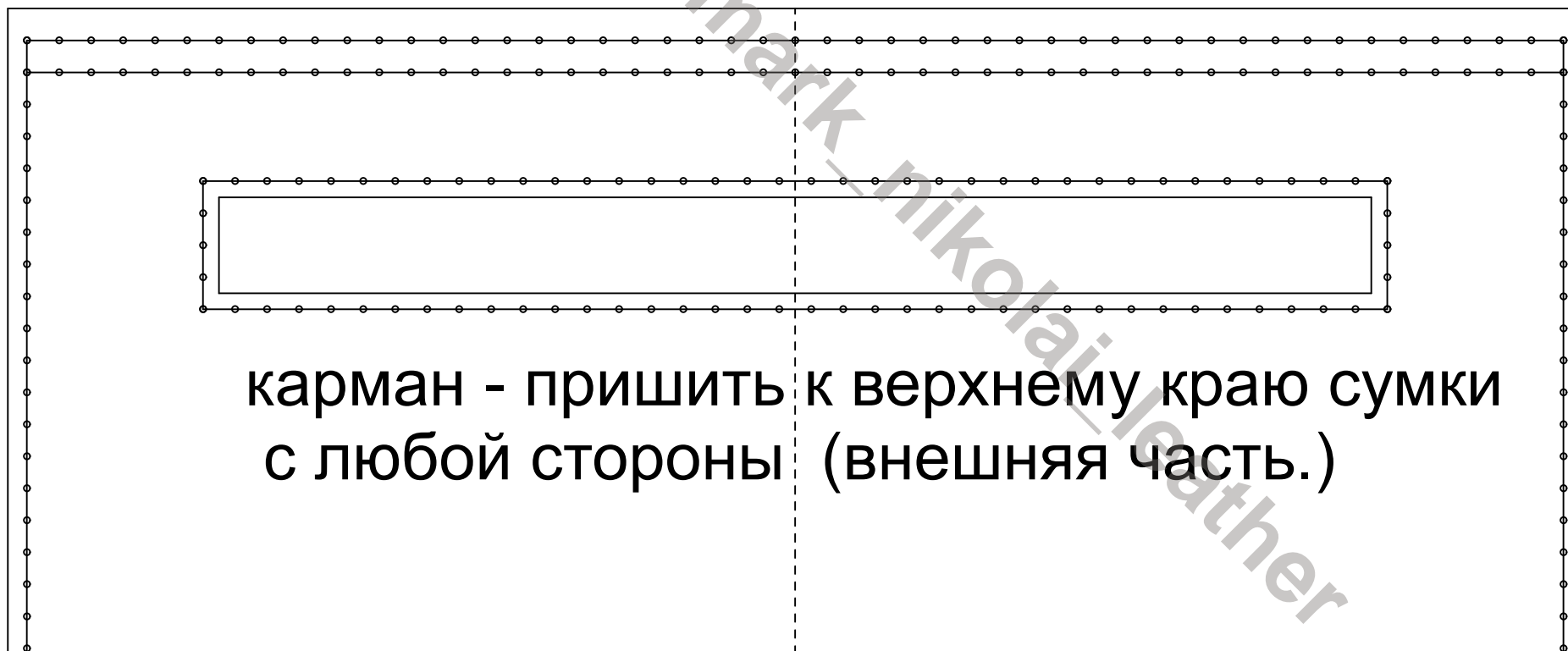
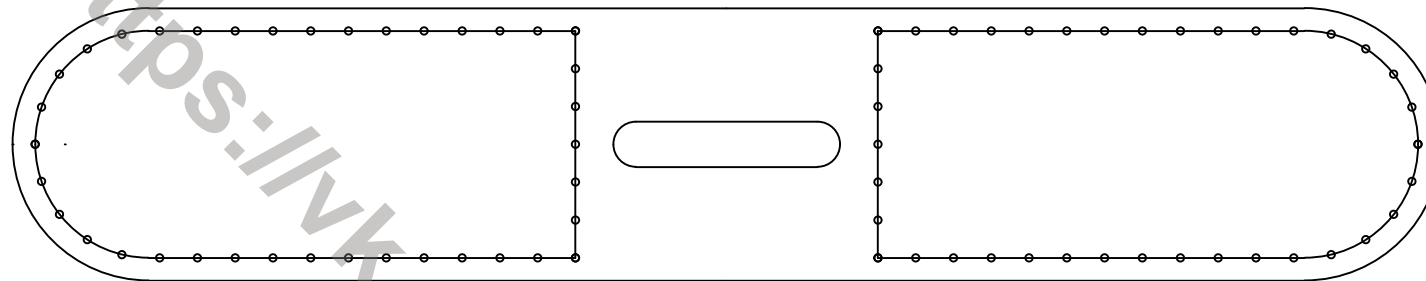

карман - пришить к верхнему краю сумки  
с любой стороны (внешняя часть.)

[https://vk.com/mark\\_nikolai\\_leather](https://vk.com/mark_nikolai_leather)



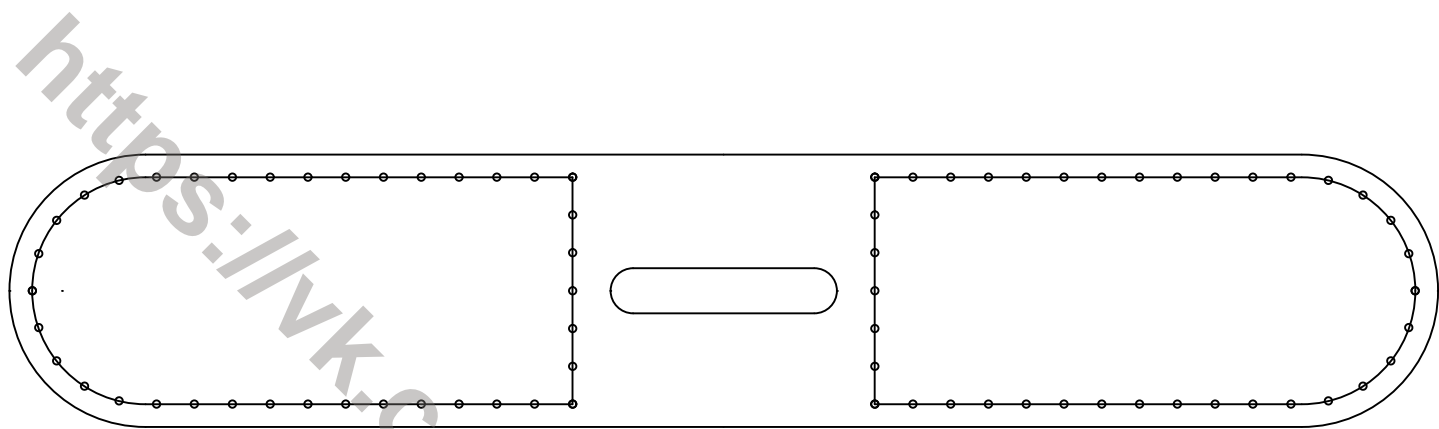

внутренняя  
часть кармана

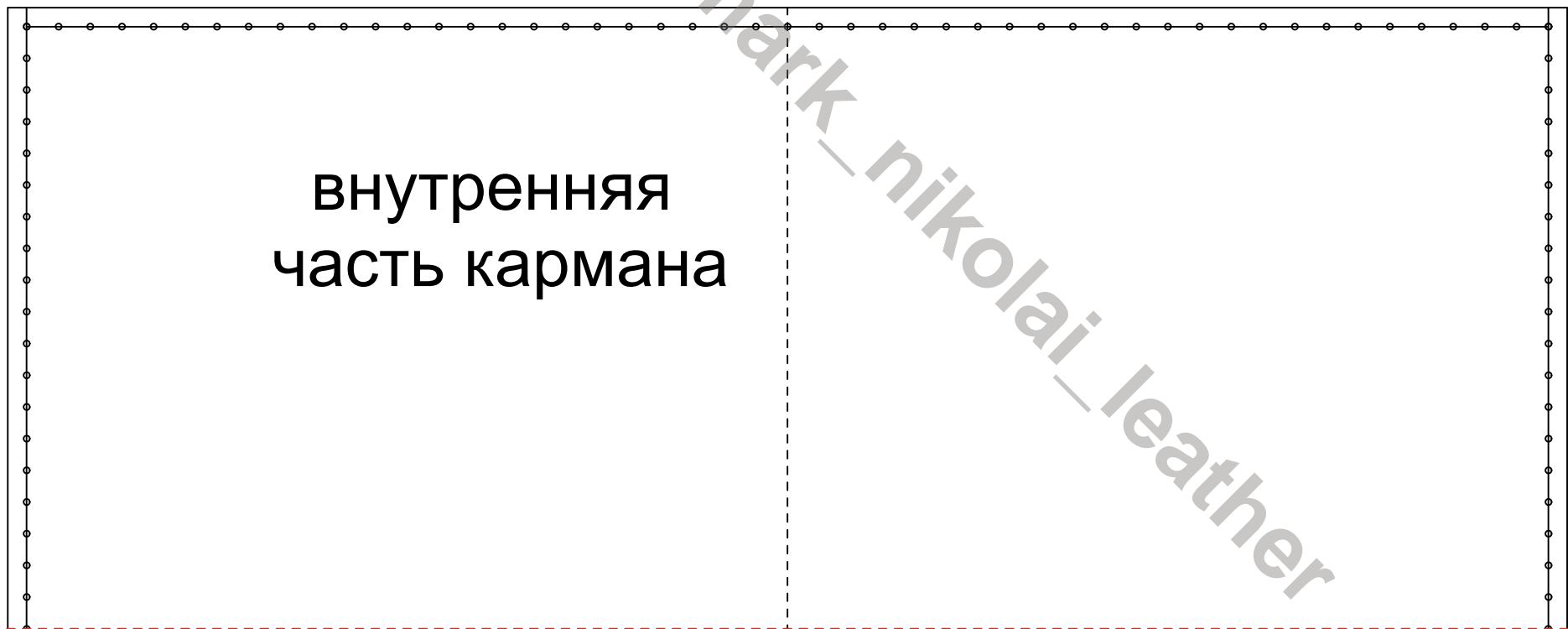

[https://vk.com/mark\\_nikolai\\_leather](https://vk.com/mark_nikolai_leather)

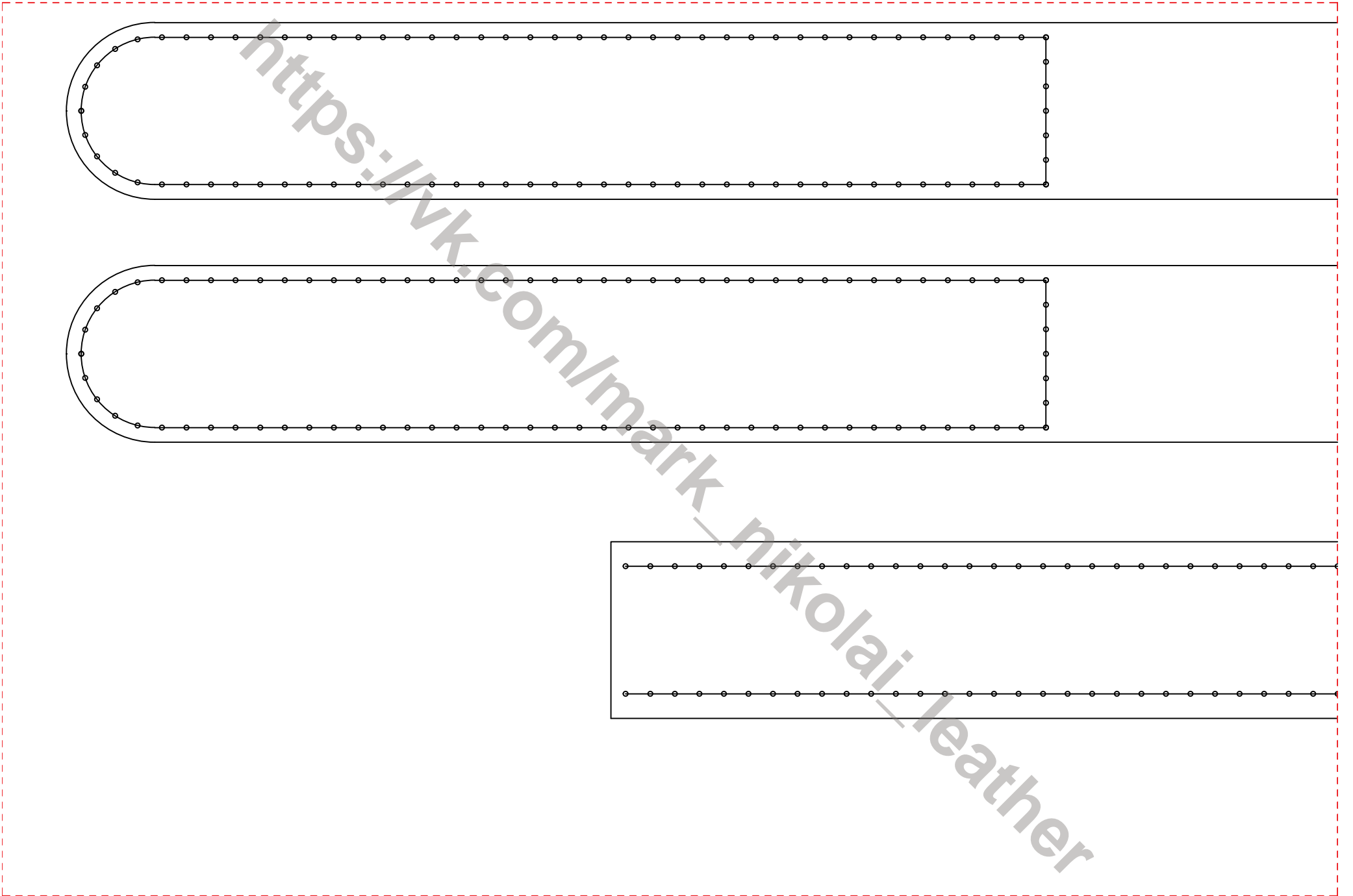

[https://vk.com/mark\\_nikolai\\_leather](https://vk.com/mark_nikolai_leather)

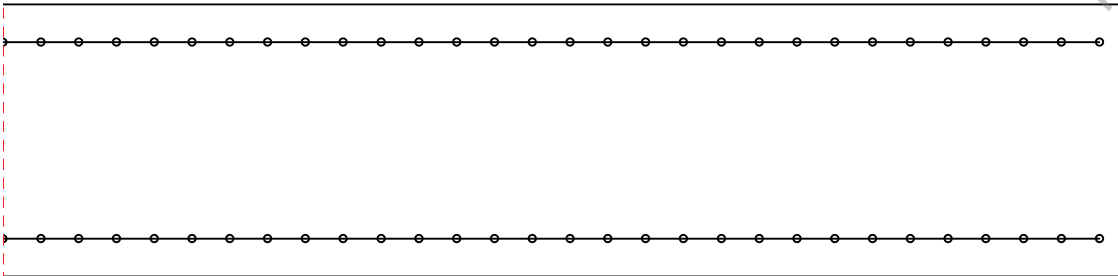

[https://vk.com/mark\\_nikolai\\_leather](https://vk.com/mark_nikolai_leather)

