

https://vk.com/mark_nikolai_leather

заказать выкройку по эскизу или фото

https://boosty.to/mark_nikolai

купить готовые выкройки и скачать бесплатные

а 1.1

передняя стенка



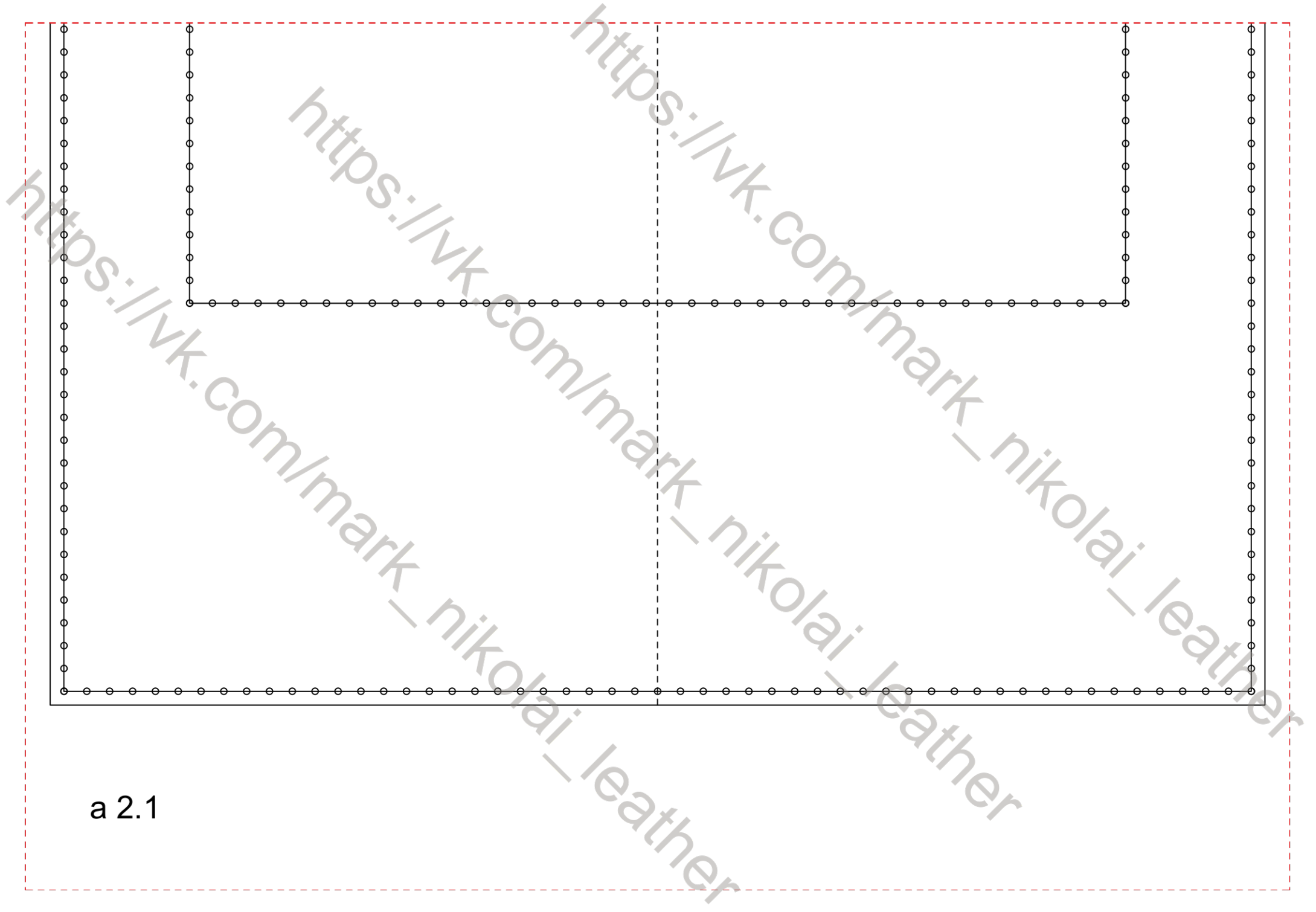

a 2.1

b 1.1

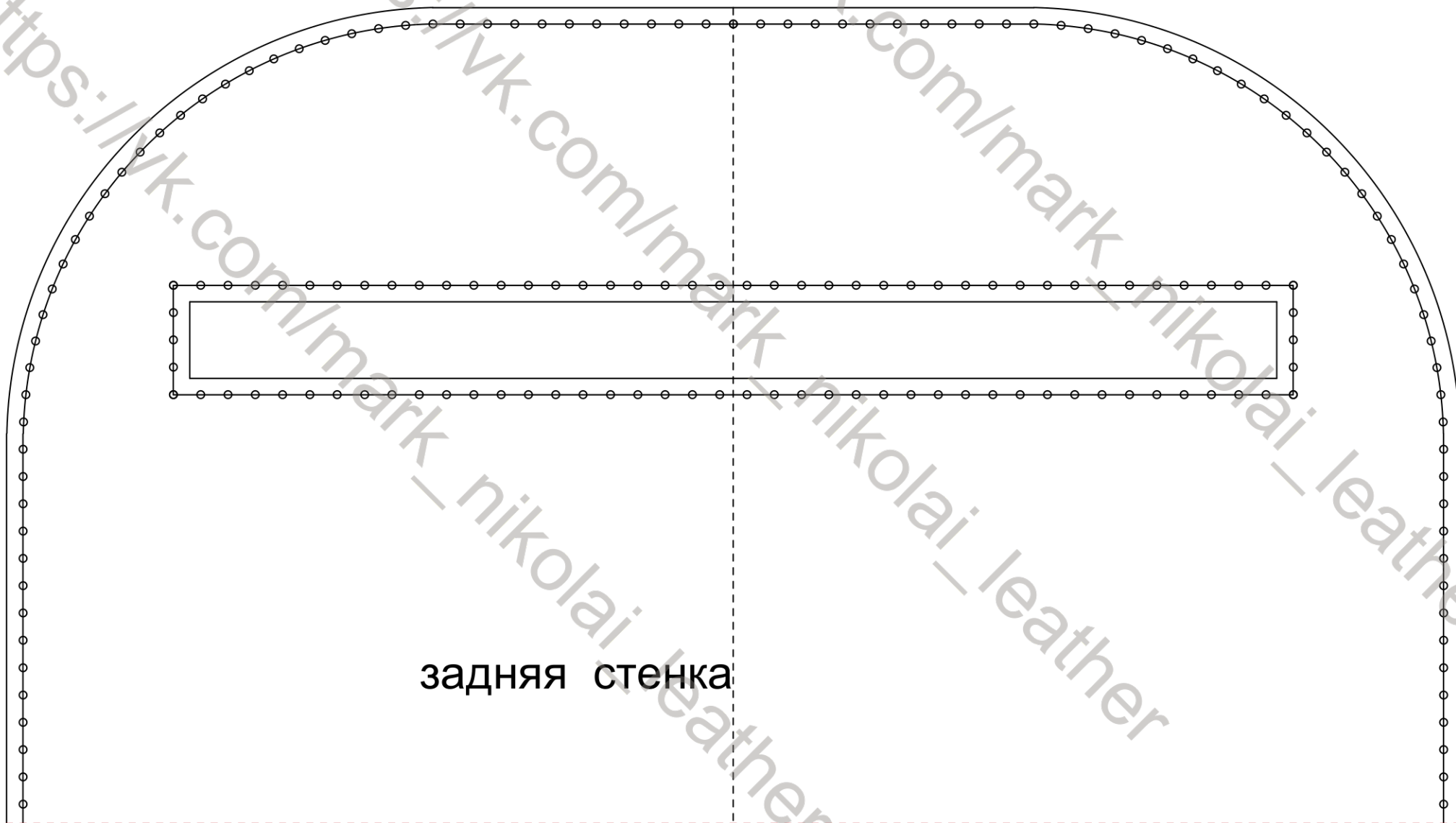

задняя стенка

b 2.1

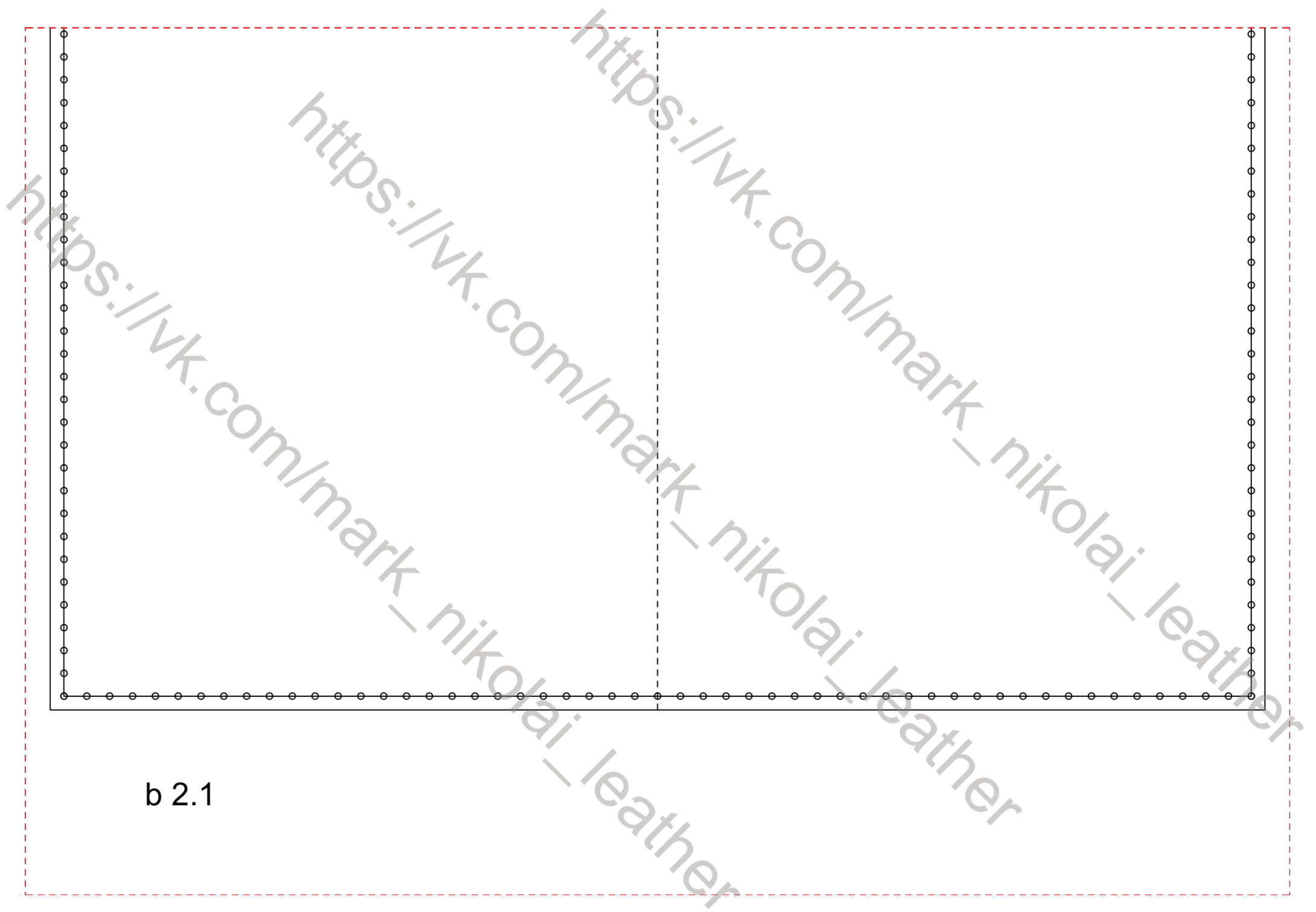

с

клапан переднего кармана

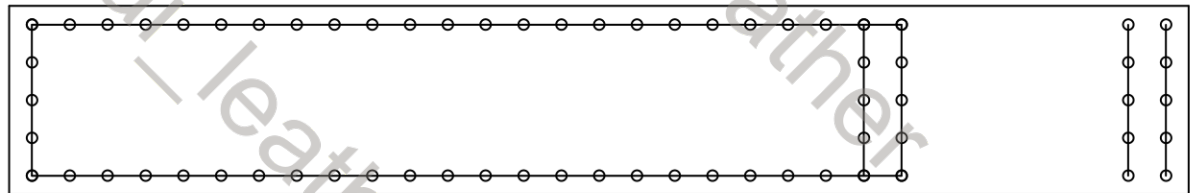
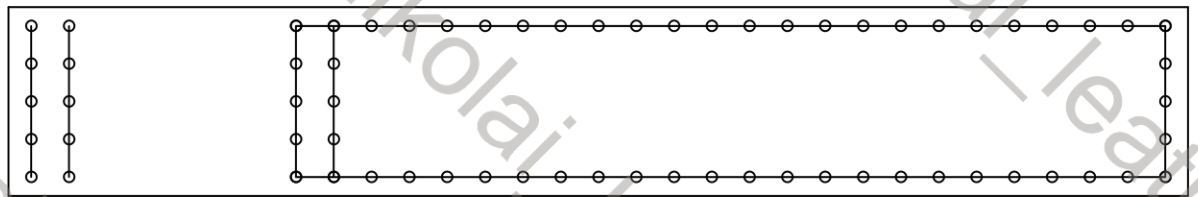
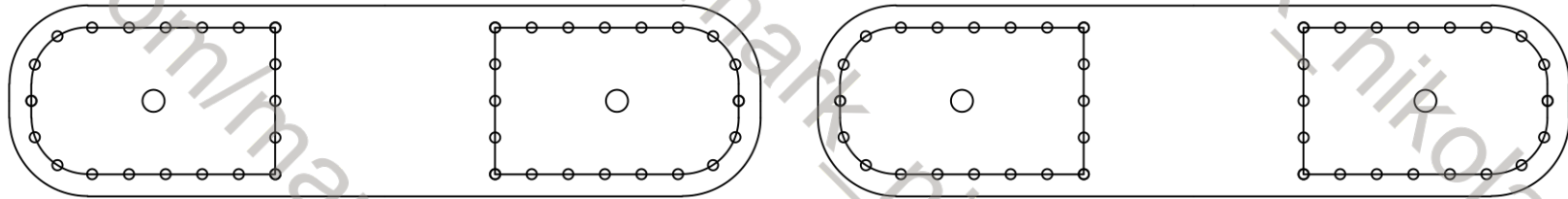
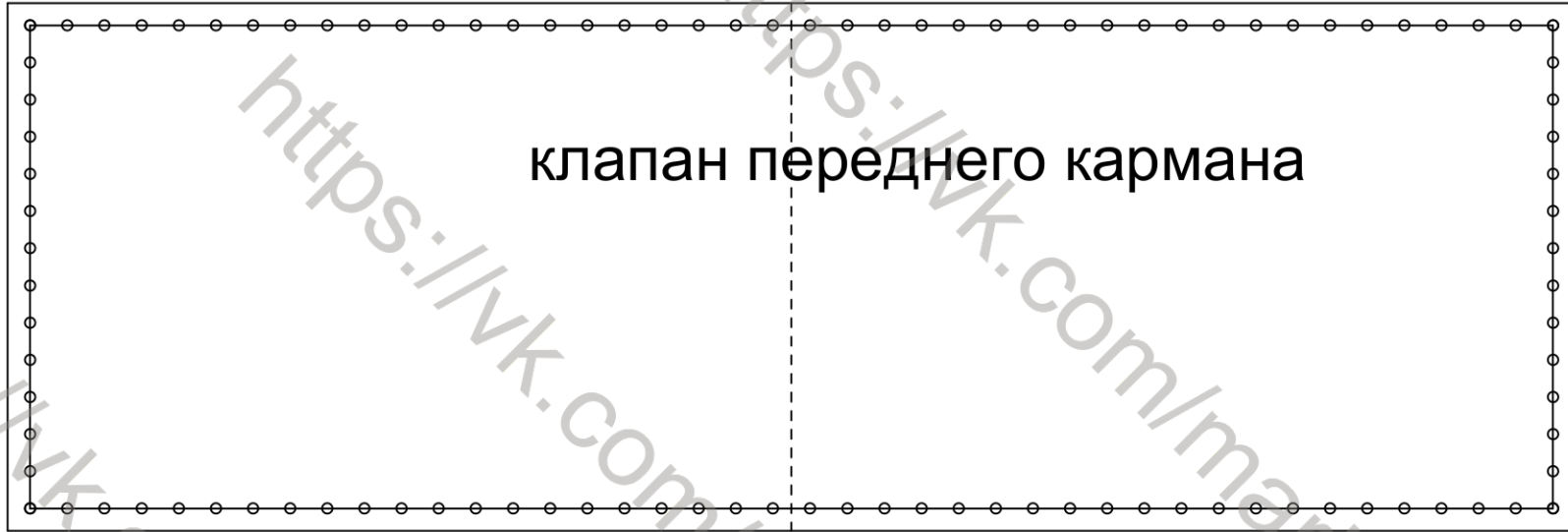

d



стенка переднего кармана

е

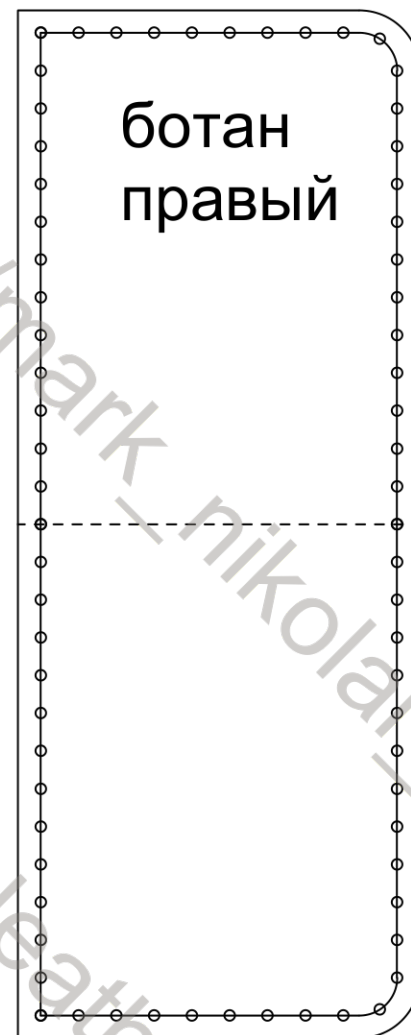
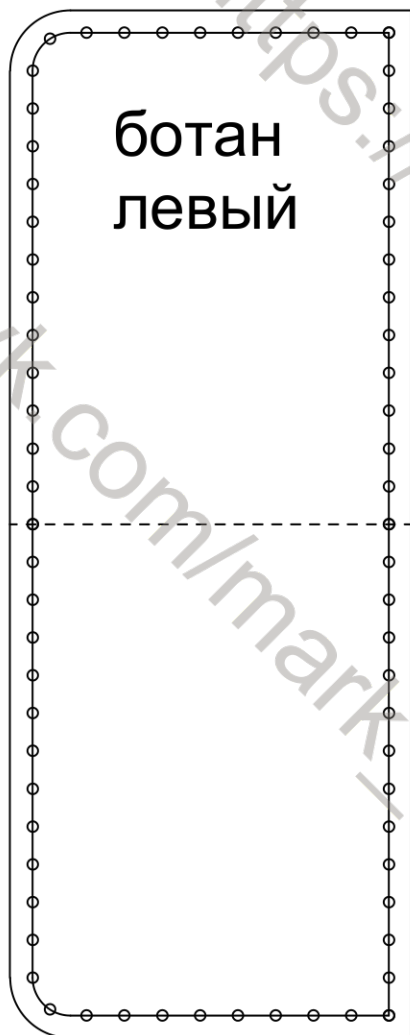

f 1.1

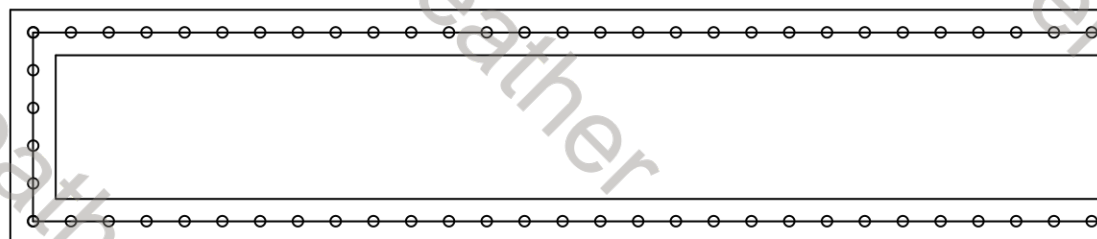
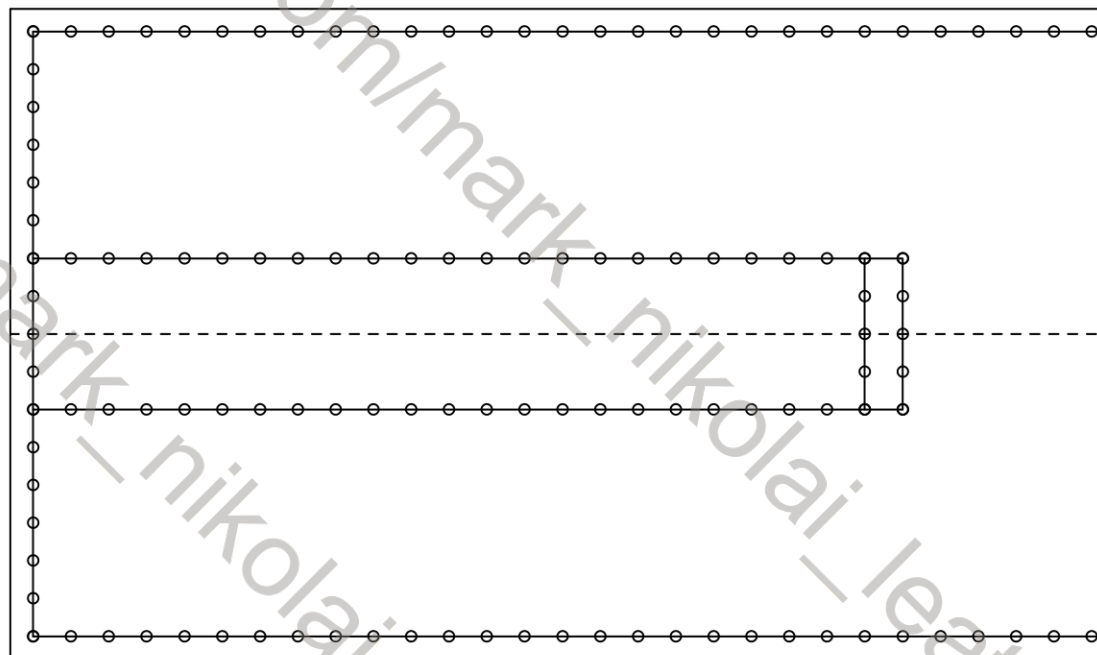
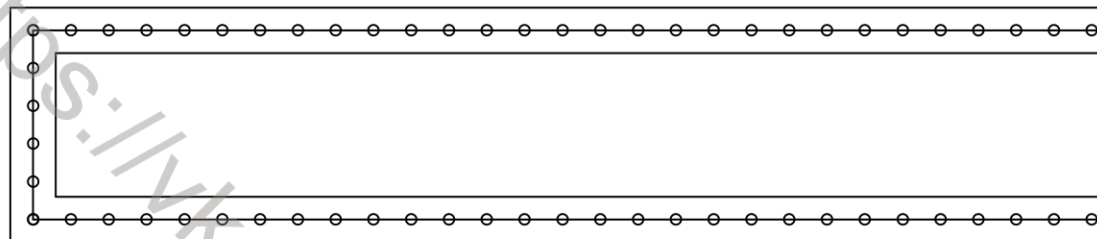

деталь для молнии - приклеивается снизу

f 1.2

ботан центр

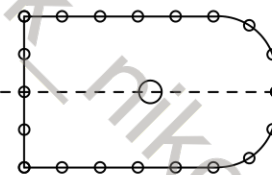
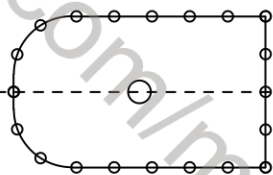

деталь для молнии - приклеивается снизу

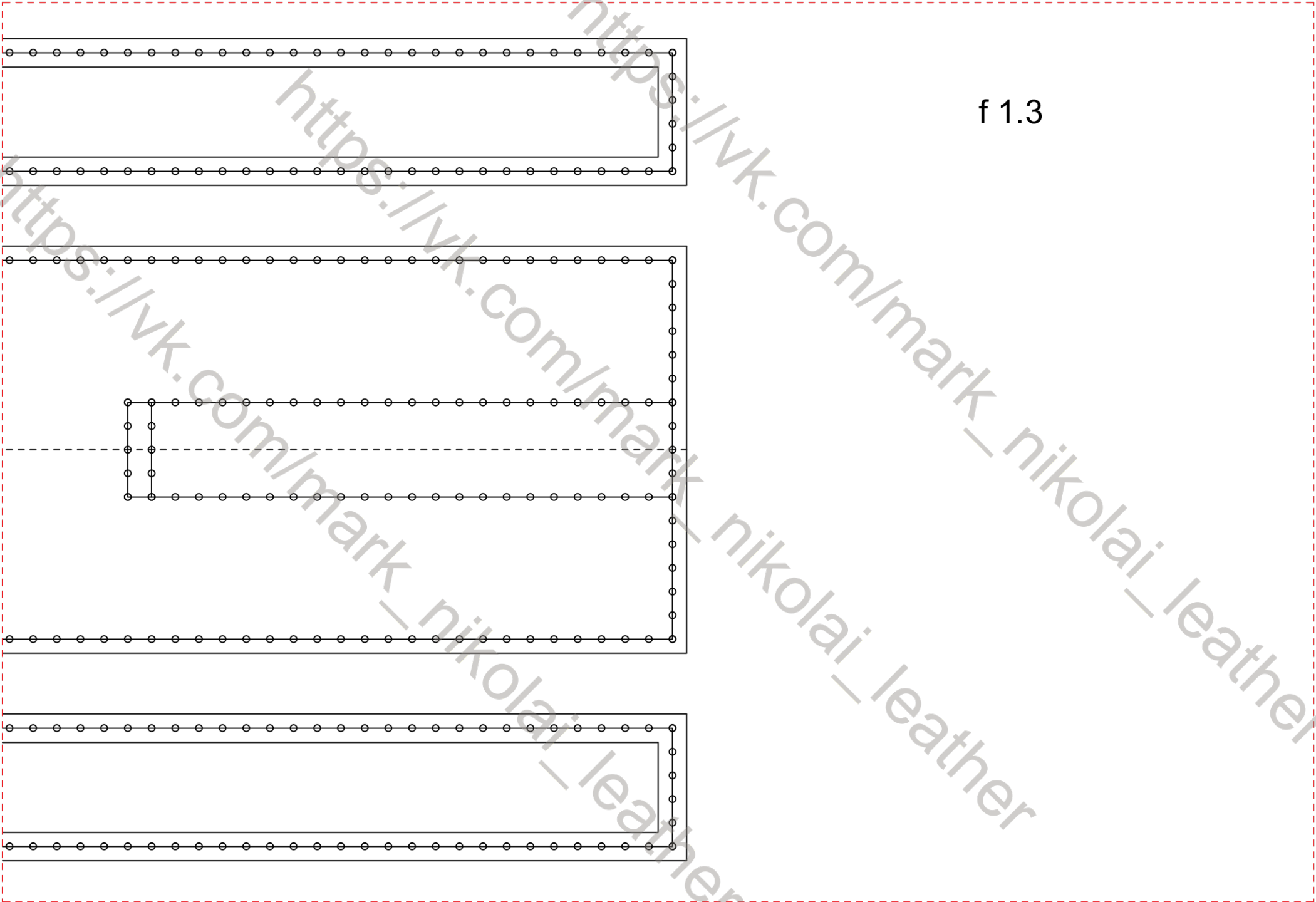

f 1.3

g 1.1

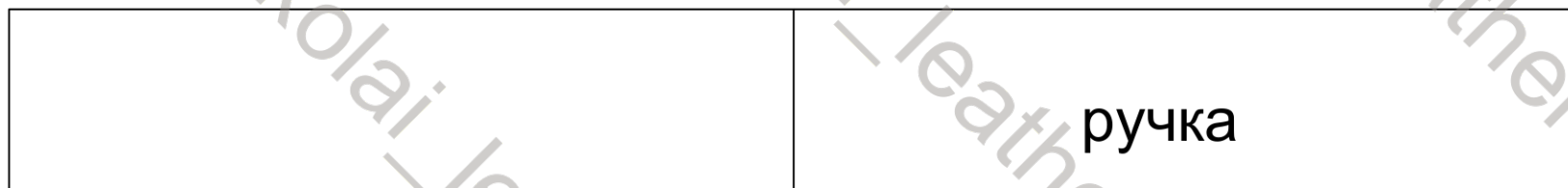
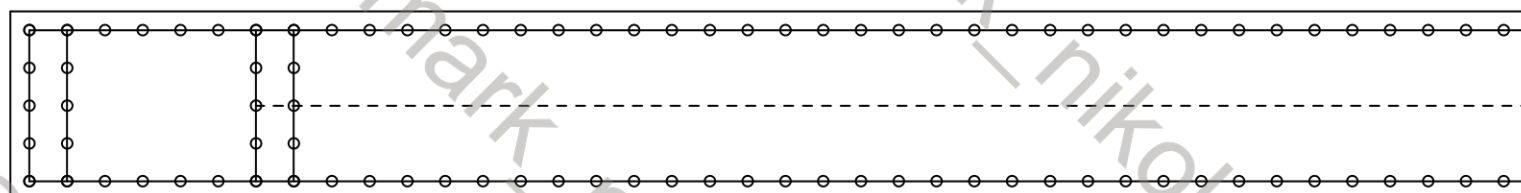
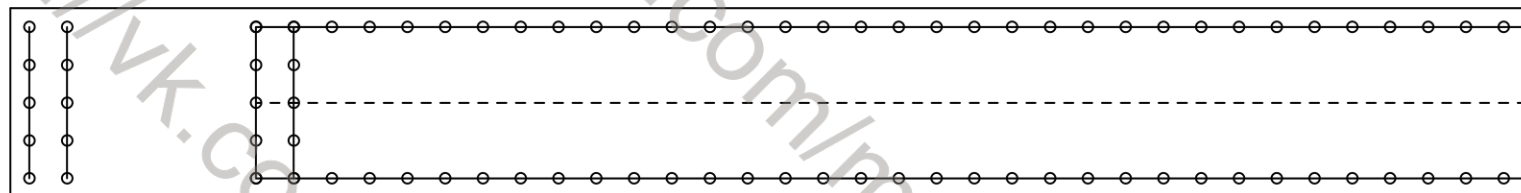

g 1.2

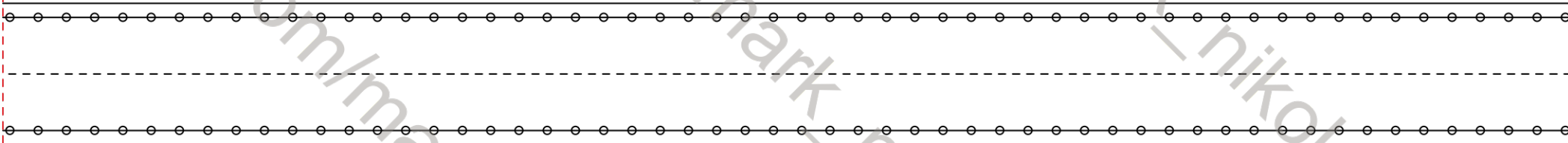
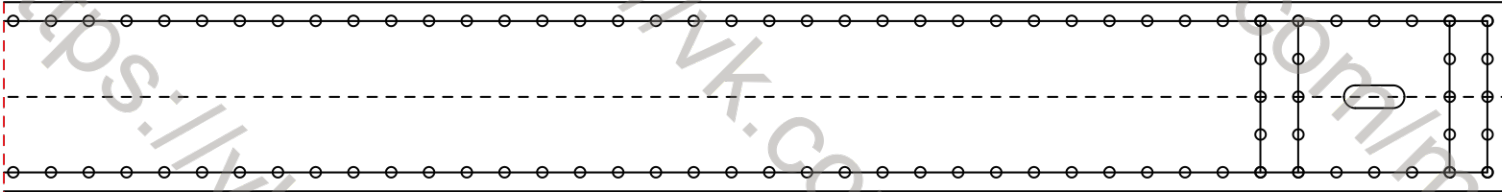

g 1.3

ручка

ТОЛЩИНА КОЖИ ПР

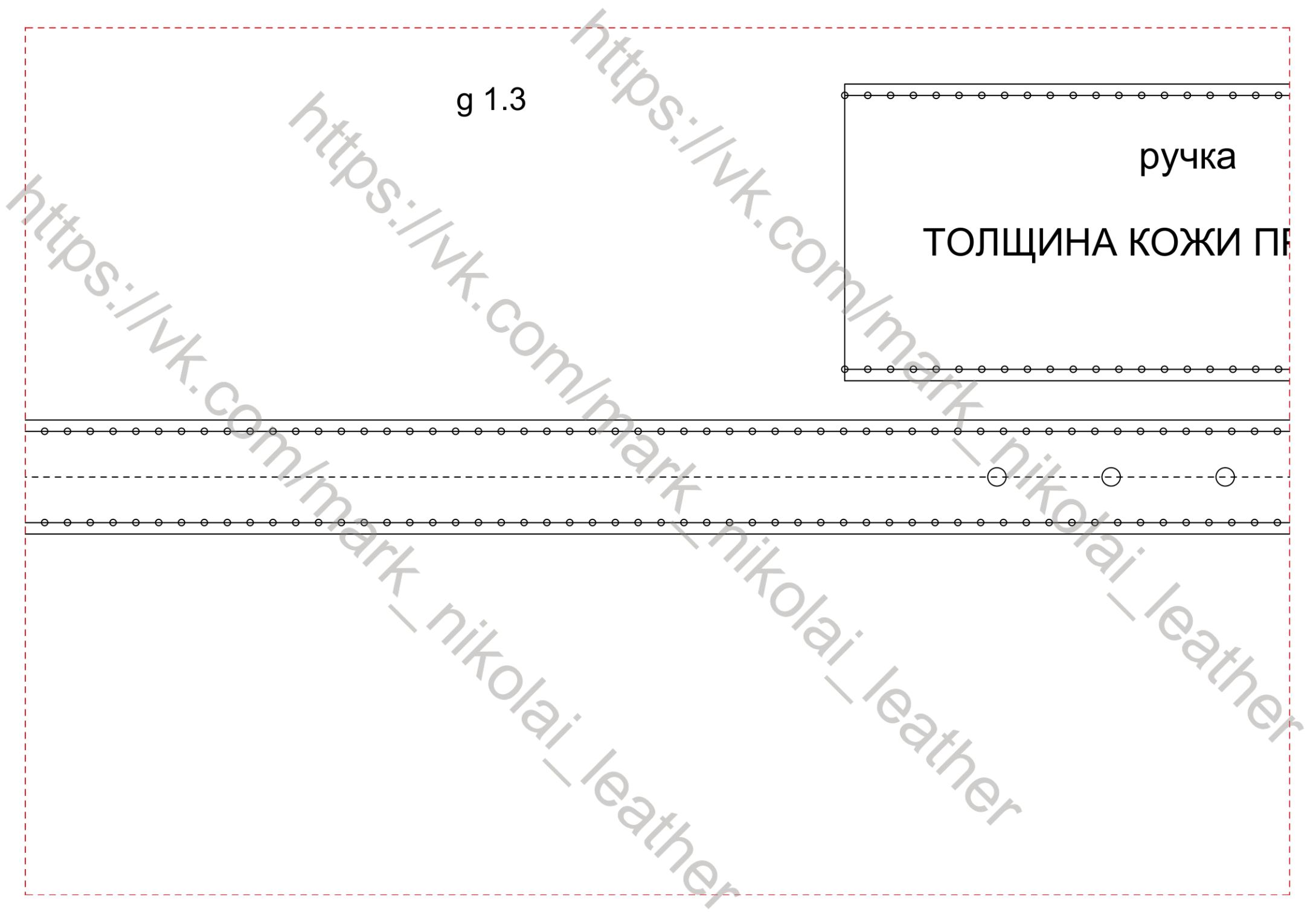

g 1.4

РИМЕРНО 1.6-1.8

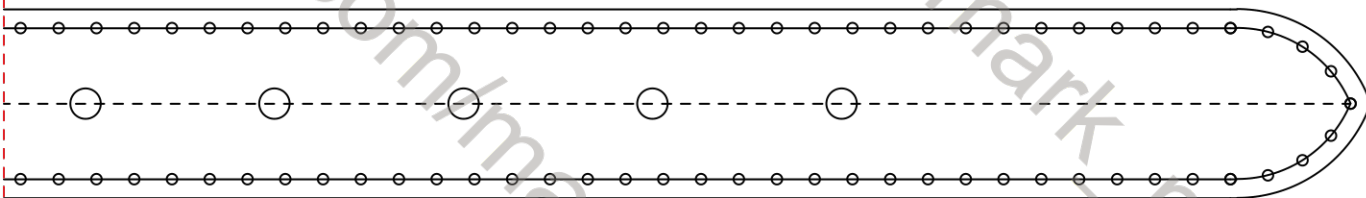

https://vk.com/mark_nikolai_leather