

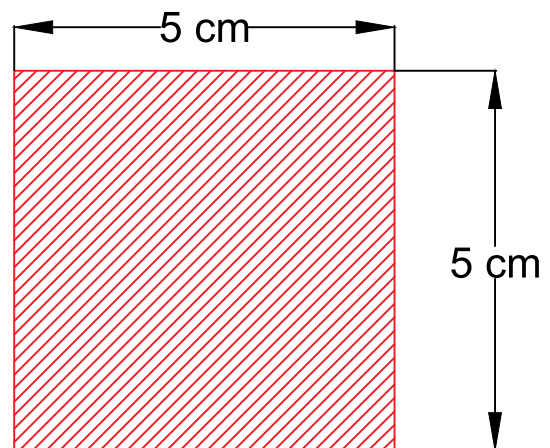

Test Page

Select A4 in the paper size printing menu
Choose "actual size" in the printing preferences
Make sure these dimensions are correct
before starting your pattern

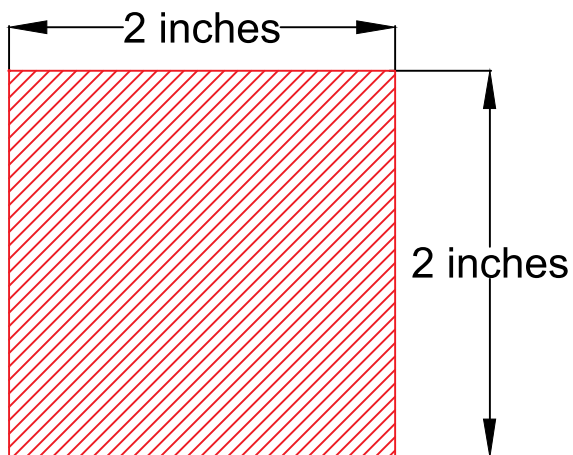

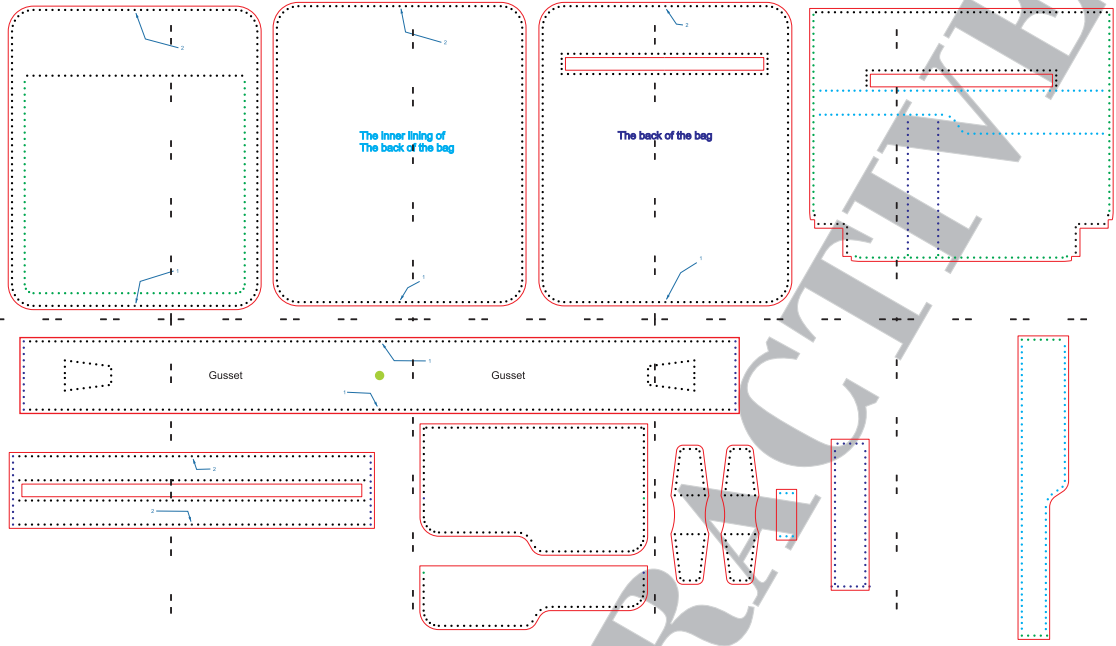



StudioAttractive
حساب تجاري على واتساب



يمكنك مسح هذا الرمز ليبدء دردشة في واتساب مع
StudioAttractive

STUDIO ATTRACTIVE

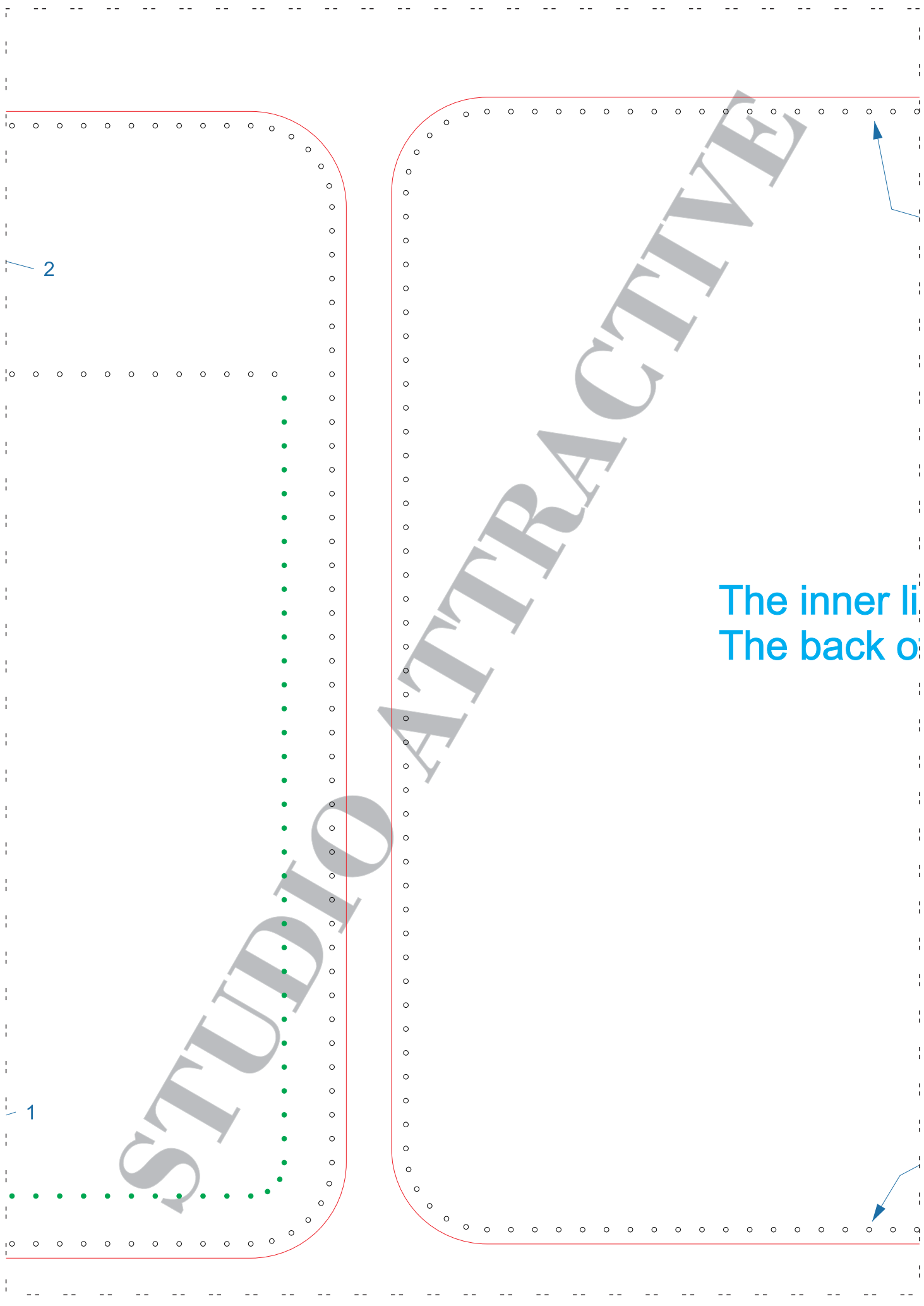



2

1

The inner li
The back o

STUDIO ATTRACTIVE

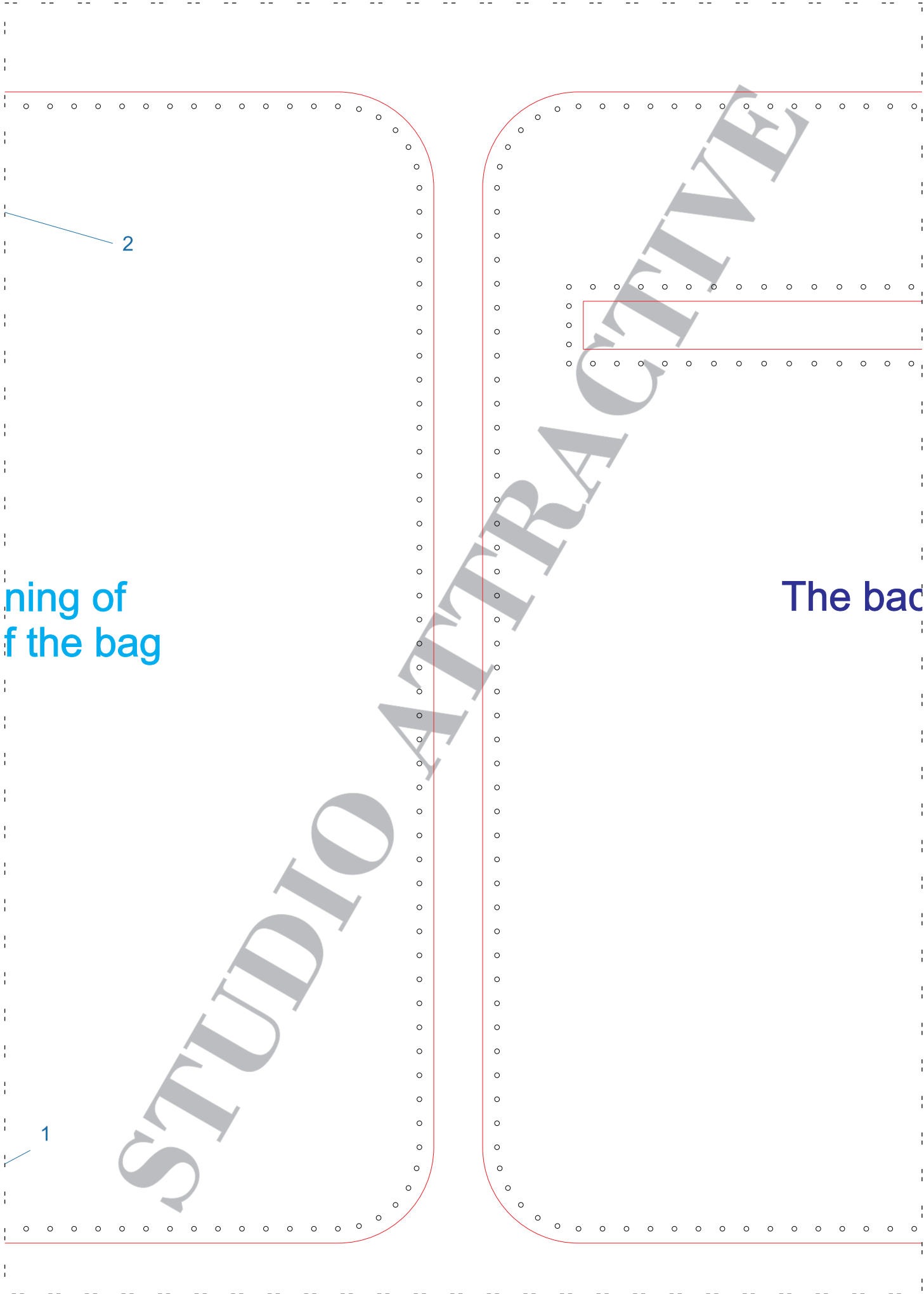

ning of
f the bag

The bac

STUDIO ATTRACTIVE

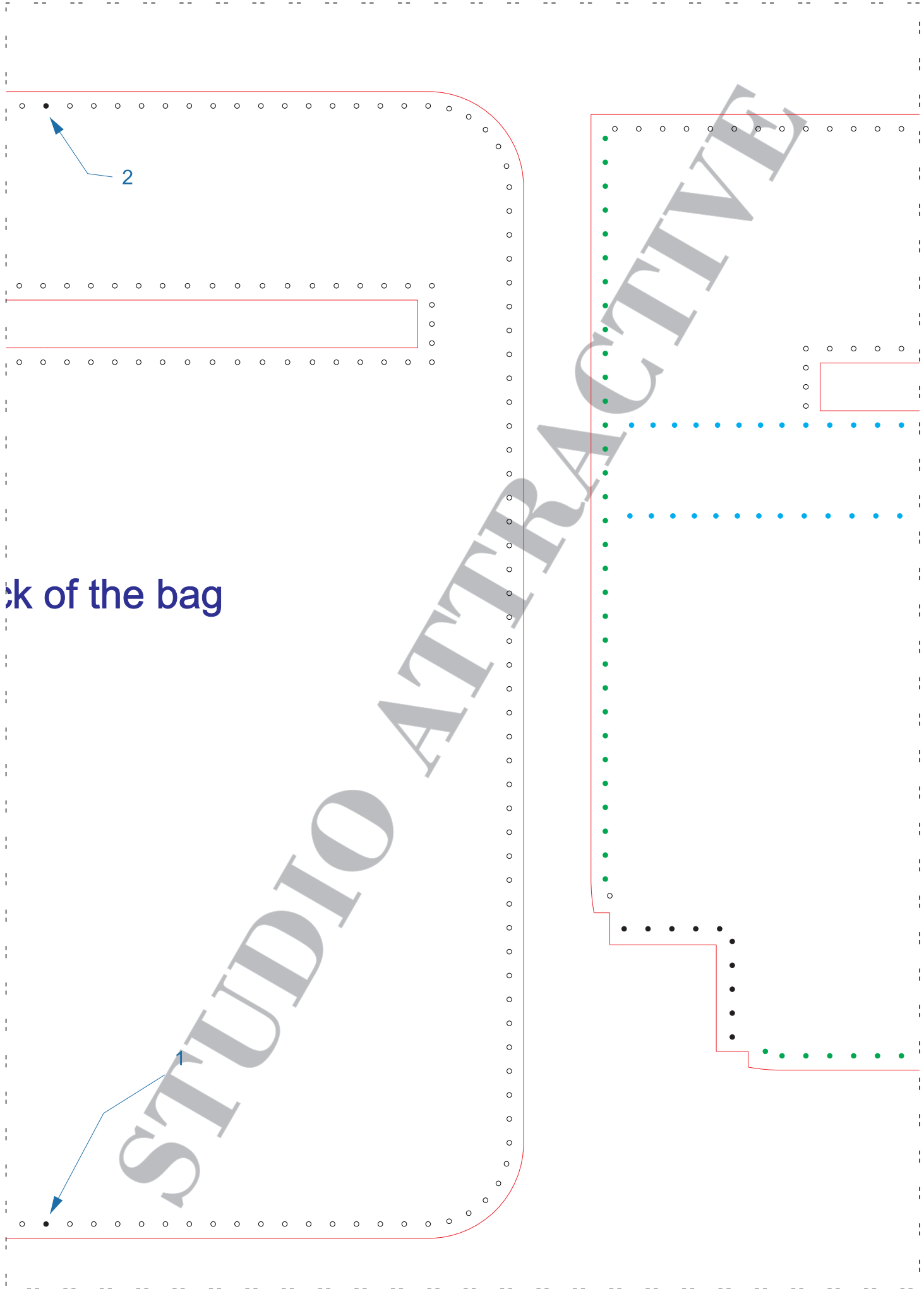

ok of the bag

STUDIO ATTRACTIVE

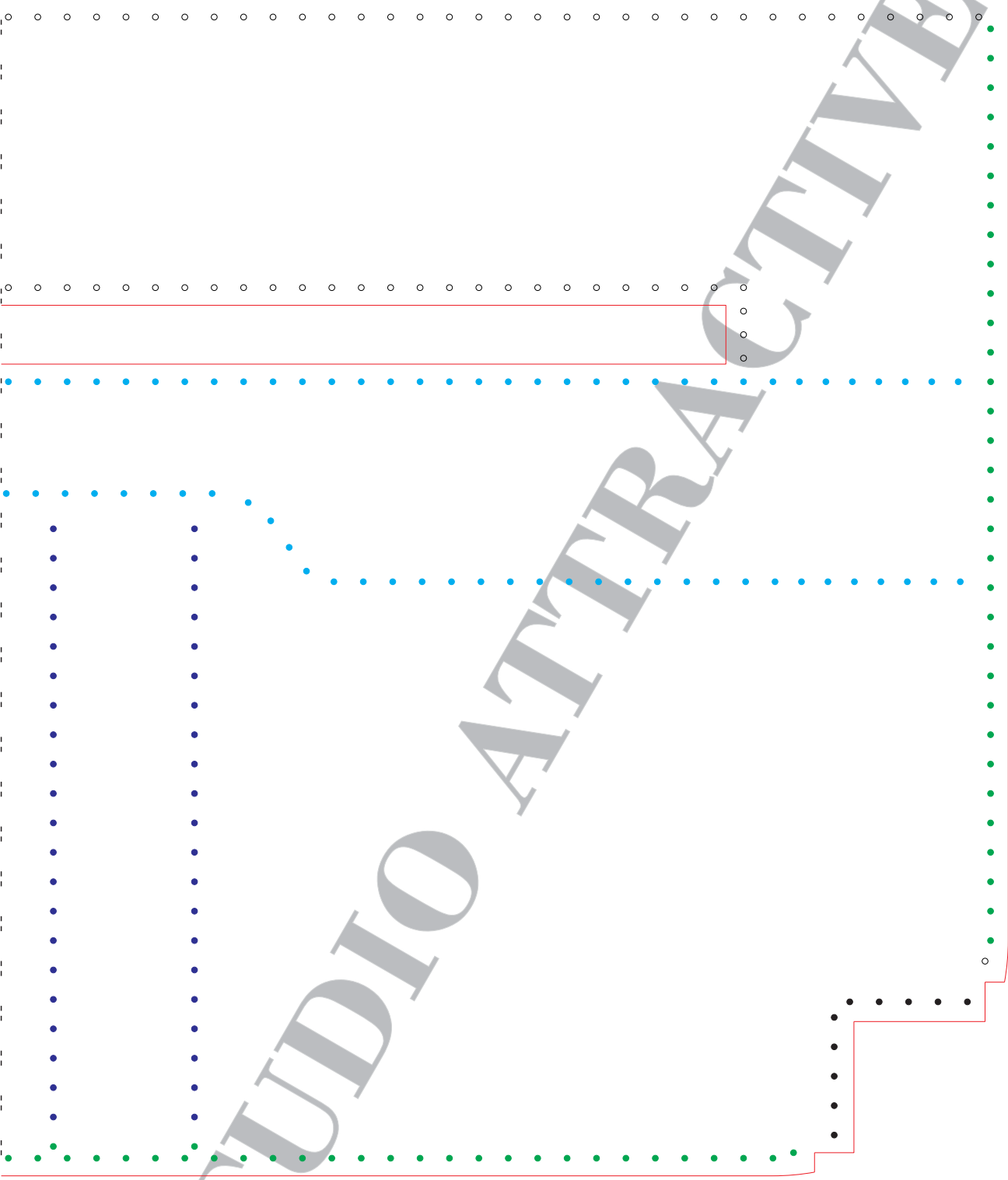

STUDIO ATTRACTIVE

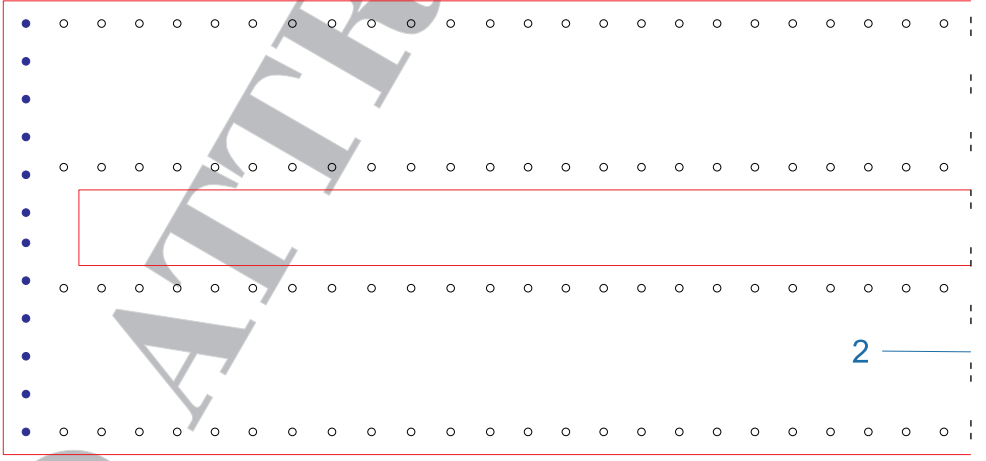
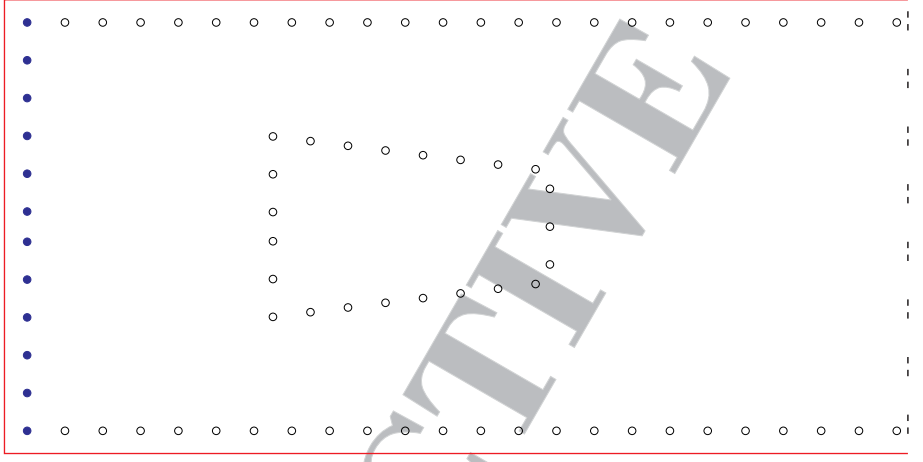

Gusset

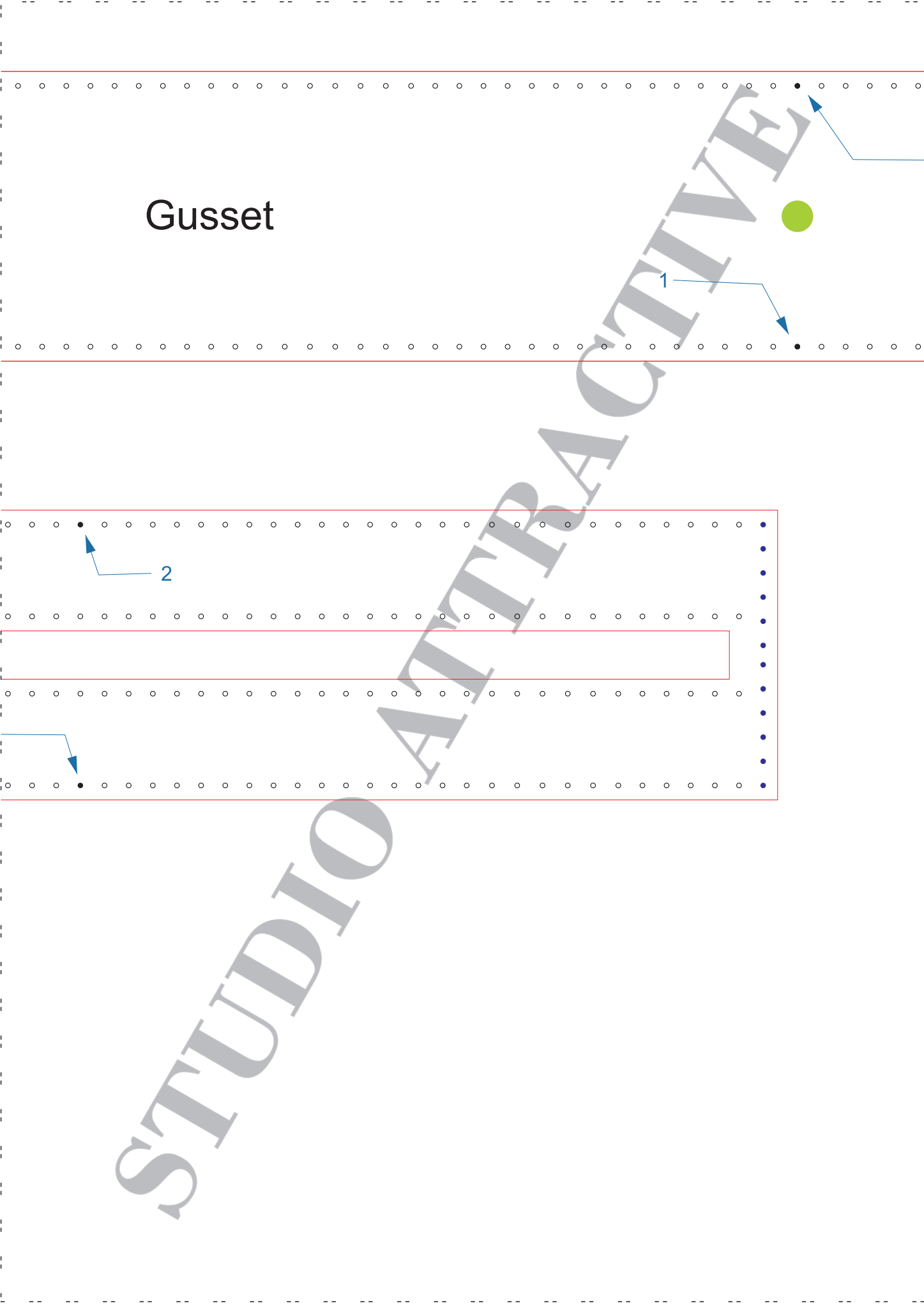

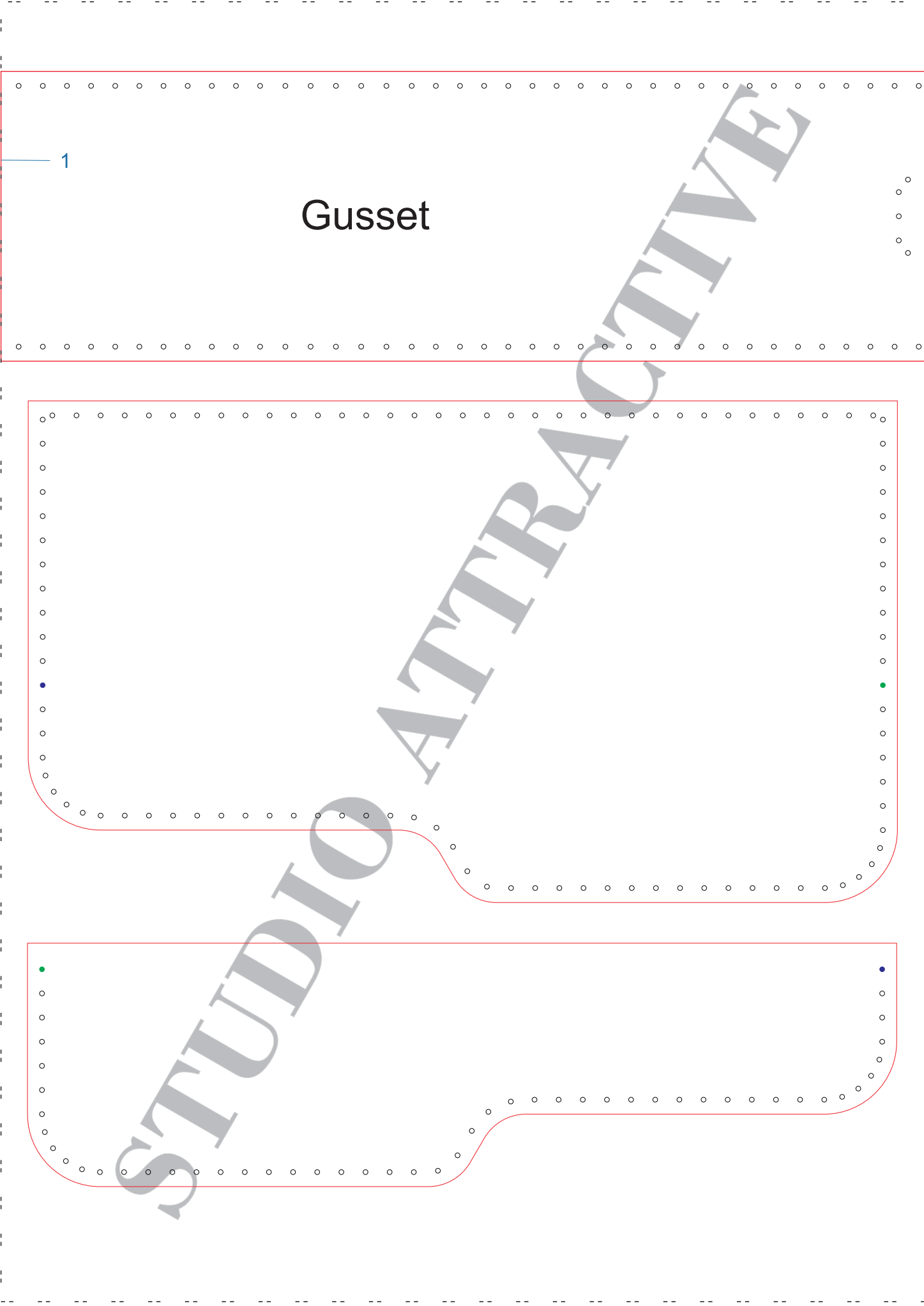

1

Gusset

STUDIO ATTRACTIVE

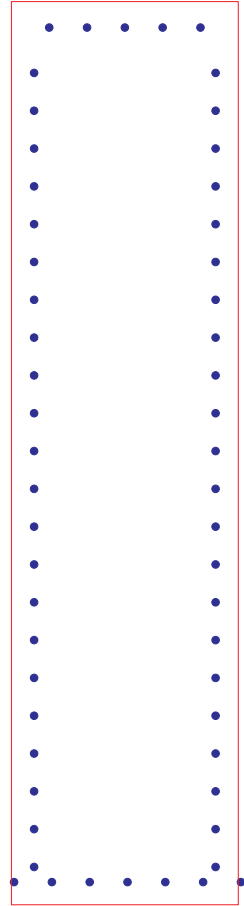
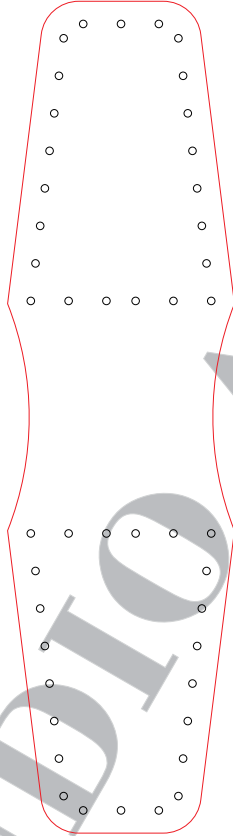
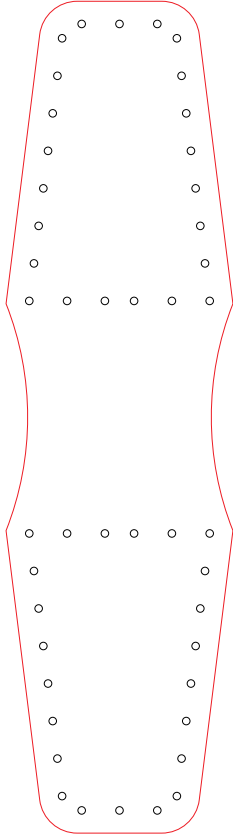
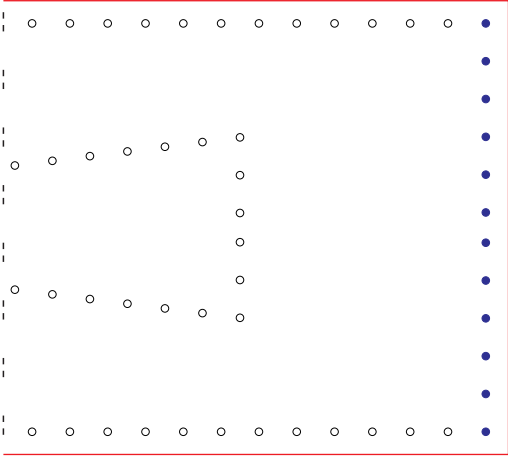

STUDIO ATTRACTIVE

STUDIO ATTRACTIVE

