

ON FLAP

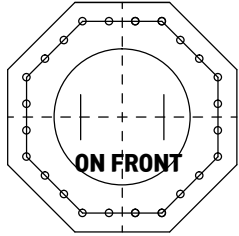

ON FRONT

D-RING ATTACHMENT/
STUDIO HAEL

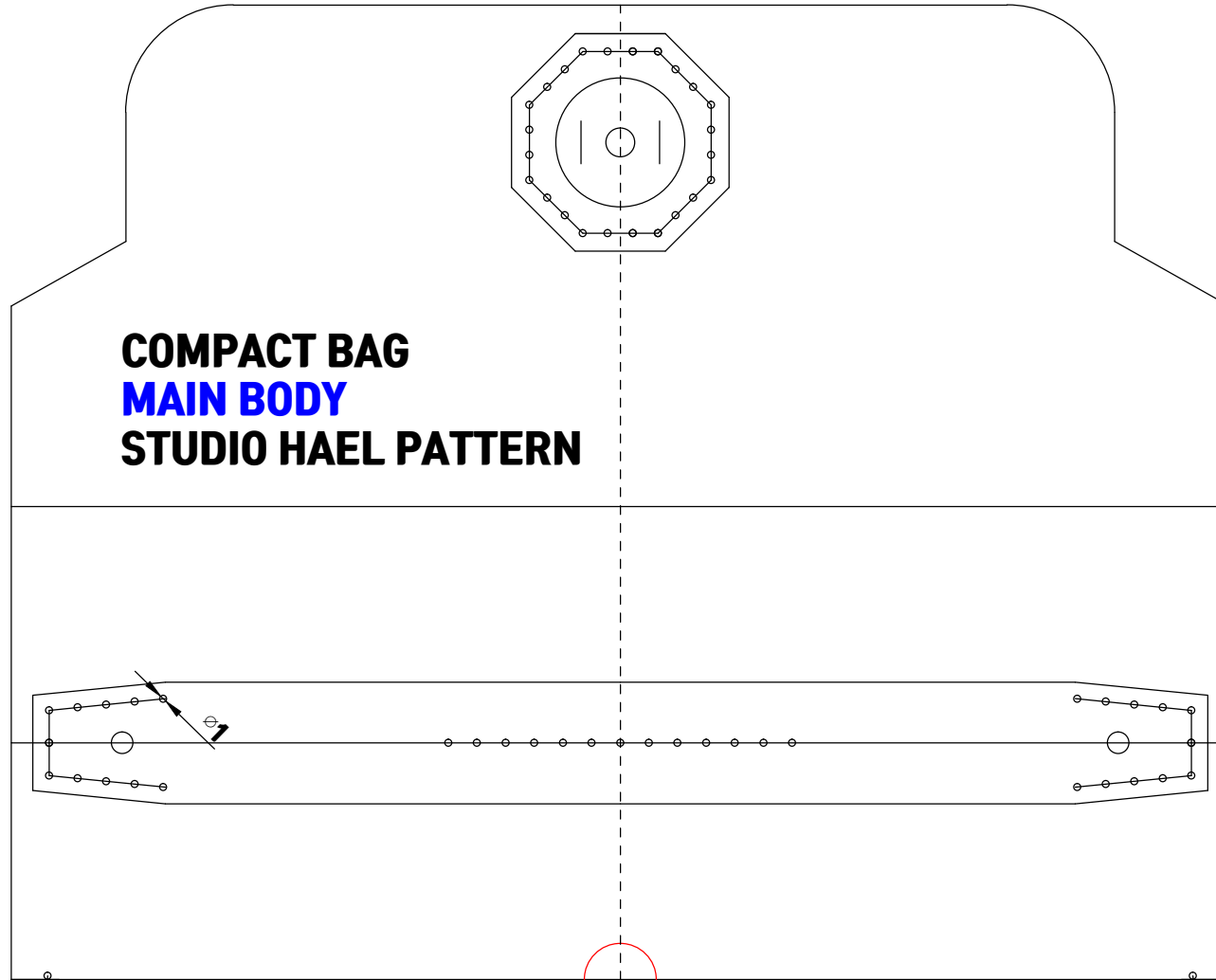
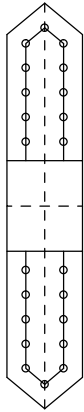

COMPACT BAG
MAIN BODY
STUDIO HAEL PATTERN

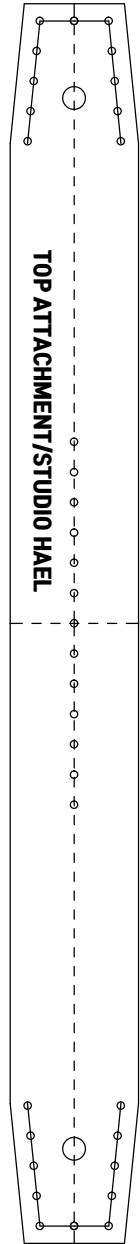

TOP ATTACHMENT/
STUDIO HAEL

-Not commercially available-
studio HAEL owns the copyright
on the patterns.

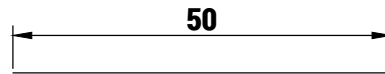

50

50mm(actual size)

50

50mm(actual size)

**COMPACT BAG
MAIN BODY
STUDIO HAEL PATTERN**

**-Not commercially available-
studio HAEL owns the copyright
on the patterns.**

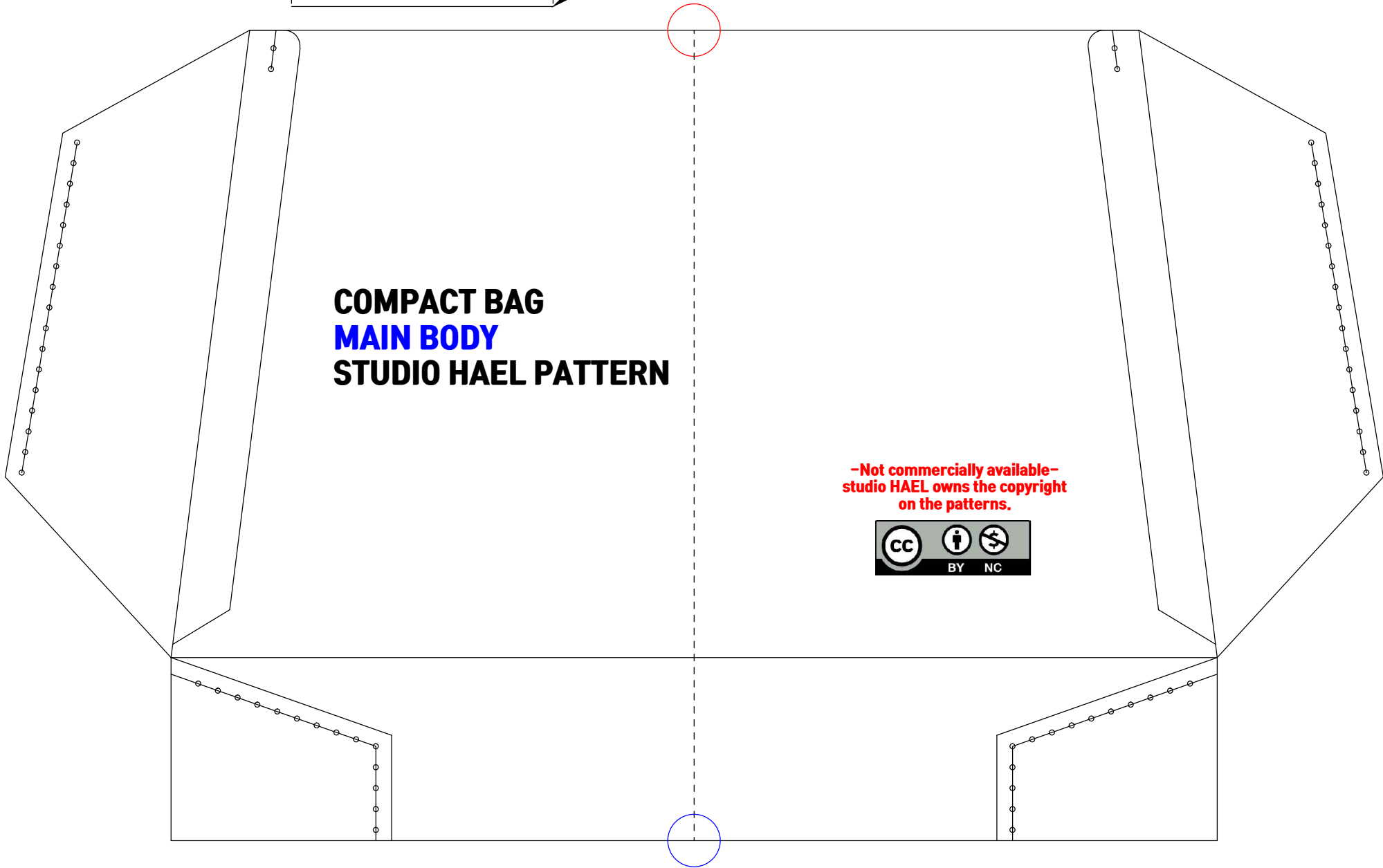

50

50mm(actual size)



-Not commercially available-
studio HAEL owns the copyright
on the patterns.



COMPACT BAG
MAIN BODY
STUDIO HAEL PATTERN

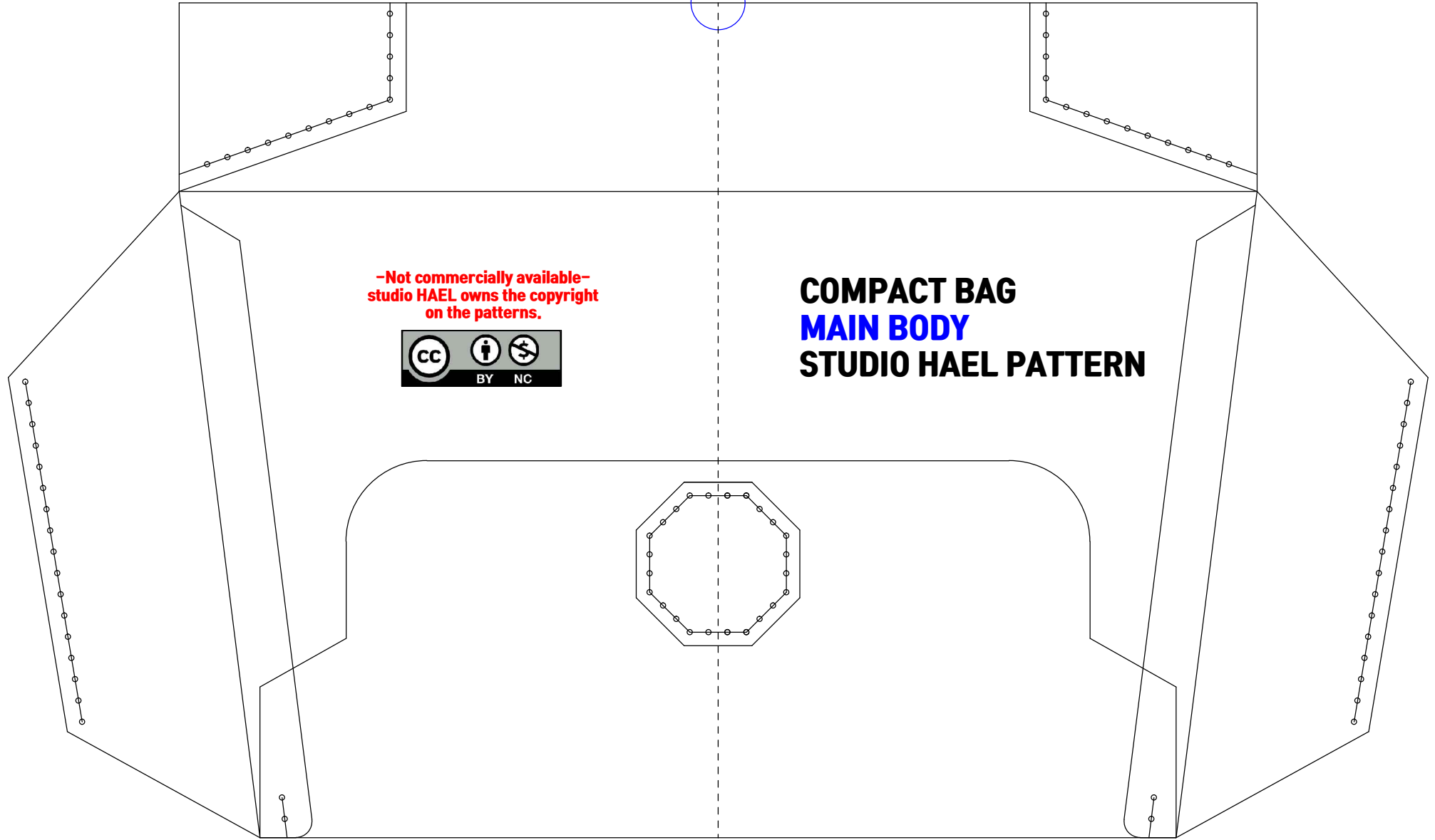

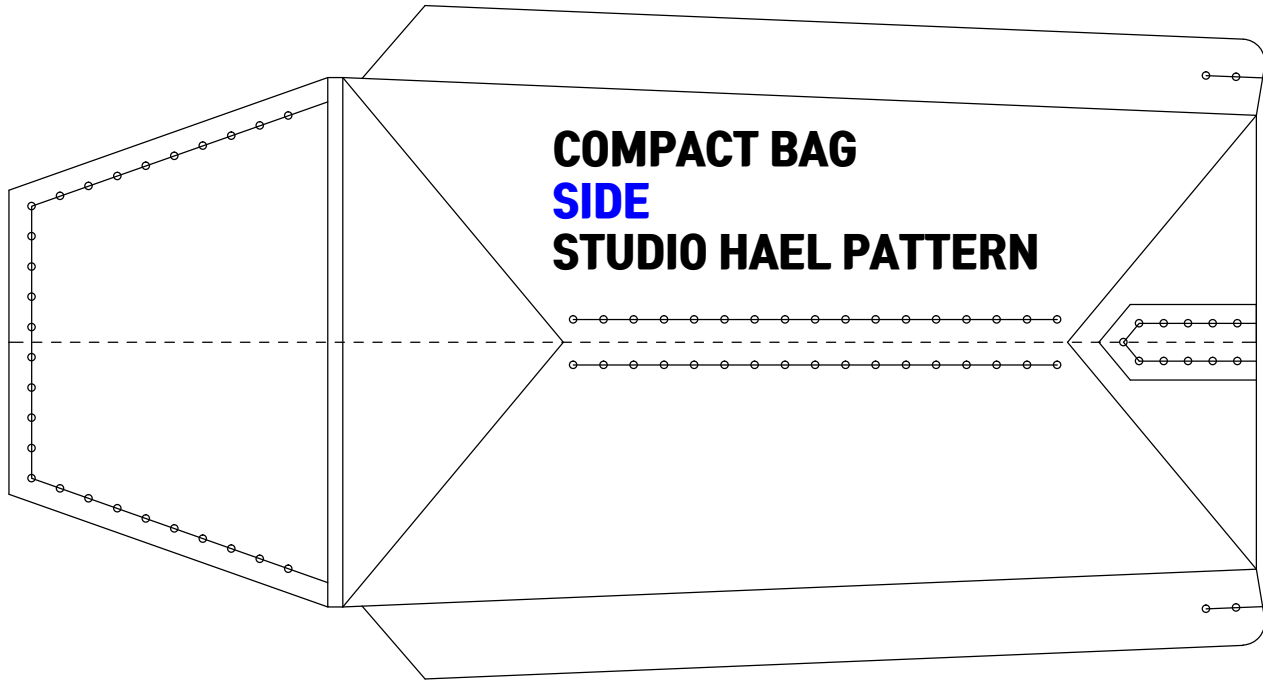

-Not commercially available-
 studio HAEL owns the copyright
 on the patterns.

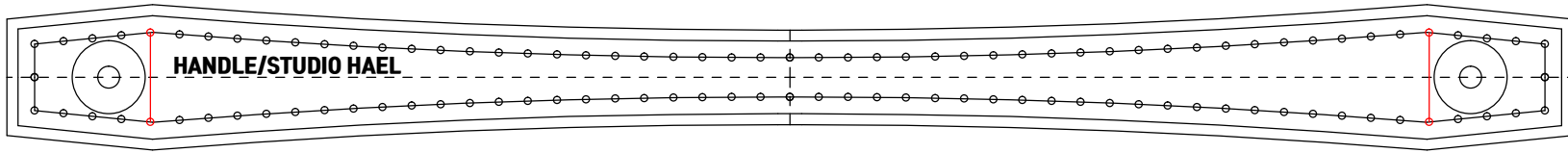
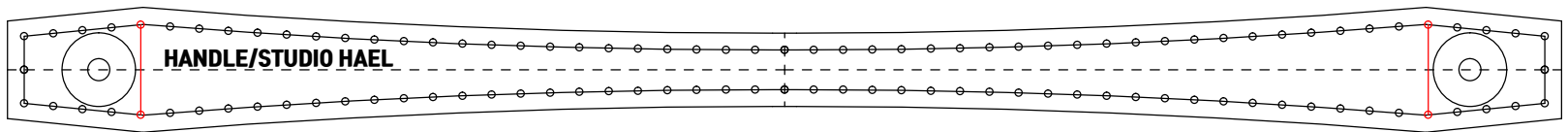

50 50mm(actual size)