



CREATIVE AWL
**ORIGINAL
PATTERNS**



CHUDLAY BRIEFCASE



 **YouTube**
VIDEO TUTORIAL

**EASY TO
PRINT**
PDF >>>>
PATTERN

LET'S GO!

1



PRINT THE PATTERN

- Open your pattern in Adobe Acrobat Reader.
Set up options of your printer on A4 paper with 0 margins.
- Every page has a measure - check does it fit.
- Every printed page **MUST HAVE** a border around!
If doesn't - move paper left/ right and print again

2



FOLLOW VIDEO INSTRUCTIONS

- Video tutorial:
<https://youtu.be/gE4gYS5Ygxk>
- Cutting patterns:
https://www.youtube.com/watch?v=2TNUI_TIk64

3



GIVE A SMILE TO OTHER PEOPLE !

- Give a ready product to you family or friend.
Give them a smile :)))
- Also Check www.CreativeAwl.com for more patterns

4



JOIN OUR FB GROUP

- Go there to share your work. Also get more DIY&ideas.
We will support you & answer all questions.

YOU NEED

MATERIALS

- ABOUT 0.3SQM (3.2 SQFT) OF LEATHER (PREFERABLY ABOUT 2MM (5 OZ))
- 2 X 20MM BELT BUCKLE
- 4X 25MM D/OR SQUARE RINGS
- 4 SNAPS
- POLYESTER WAXED THREAD 0.8MM

TOOLS

- SHARP KNIFE
- 1.2 - 1.5 MM HOLE PUNCHER / PRICKING IRONS OR AWL
- HAMMER
- 2 NEEDLES
- PAPER TAPE
- A HOME PRINTER

SHARE YOUR WORK

<https://www.facebook.com/groups/CreativeAwlPatterns>

Chudley briefcase:

pages 4 - 21

-The number in the circle shows which holes are to be connected. Example: ①

-Numbers 1, 2, 3 (...) without a circle indicate where the piece lies in the overview drawing.

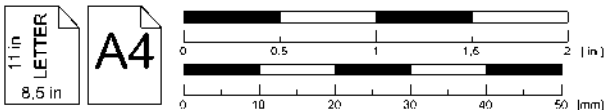
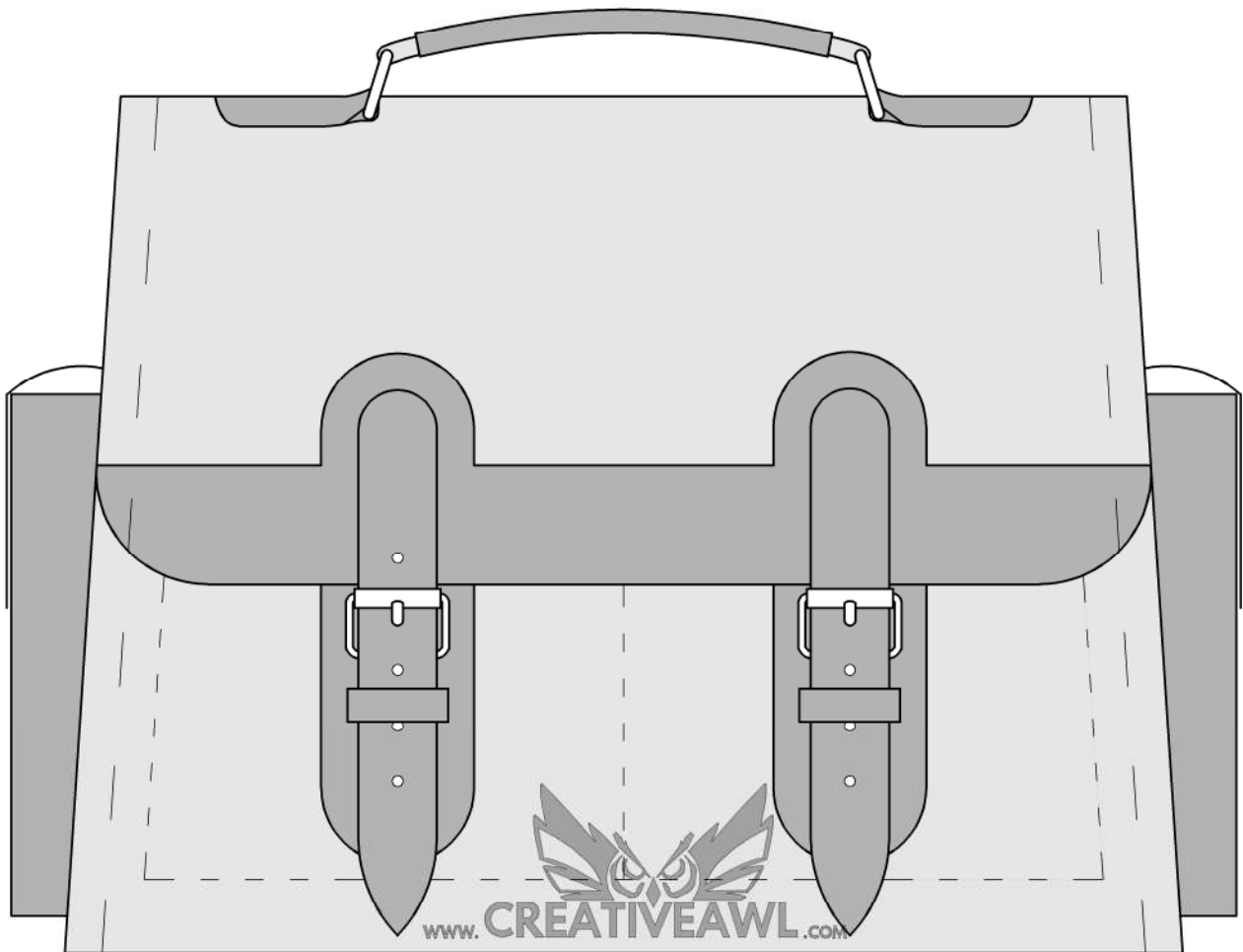

Sketch drawing

Leather needed for a Chudley briefcase: about 0,60 m2

540 mm (21.6 in)

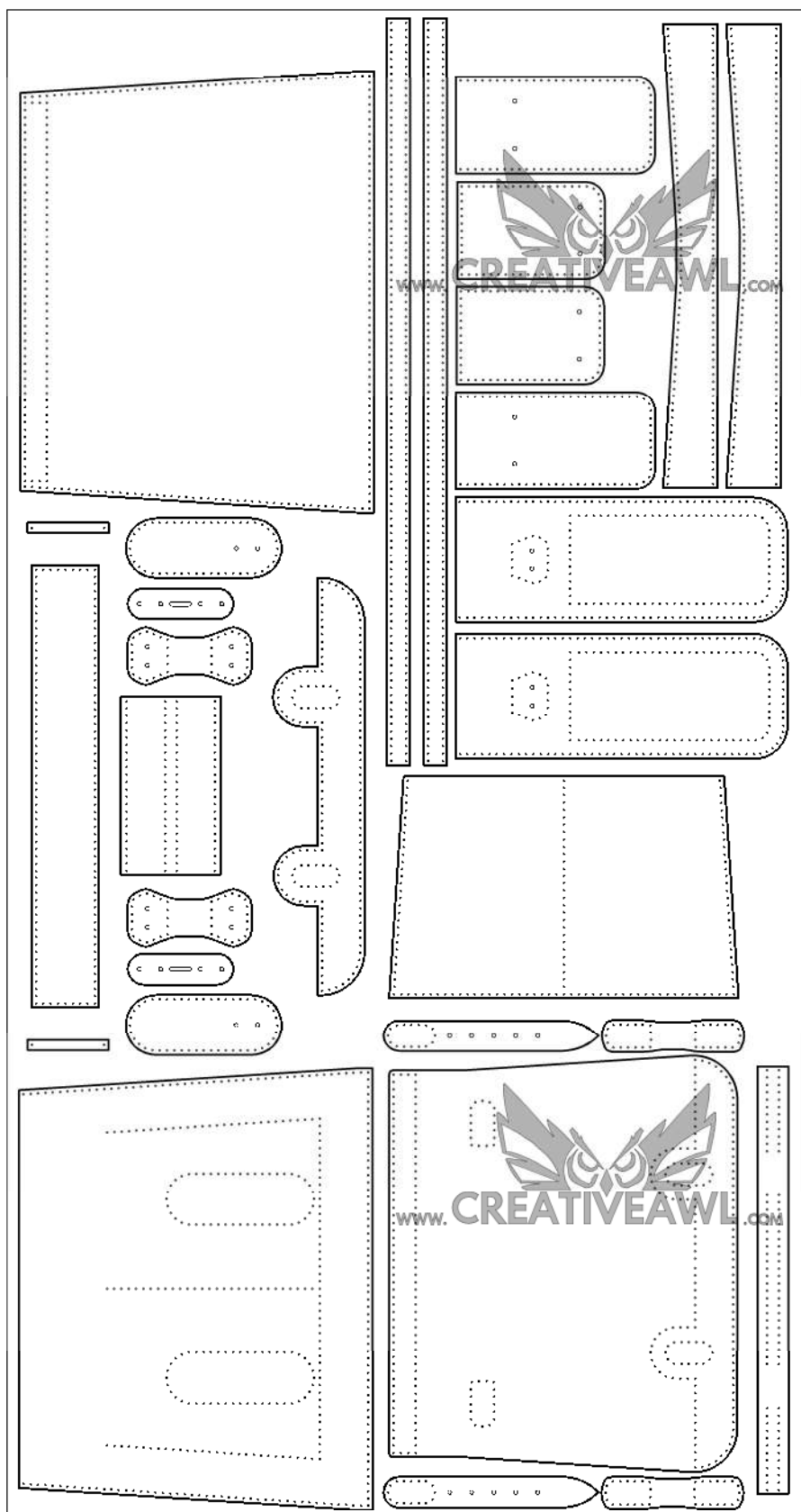

1020 mm (40.8 in)

Sketch drawing
Bill of materials

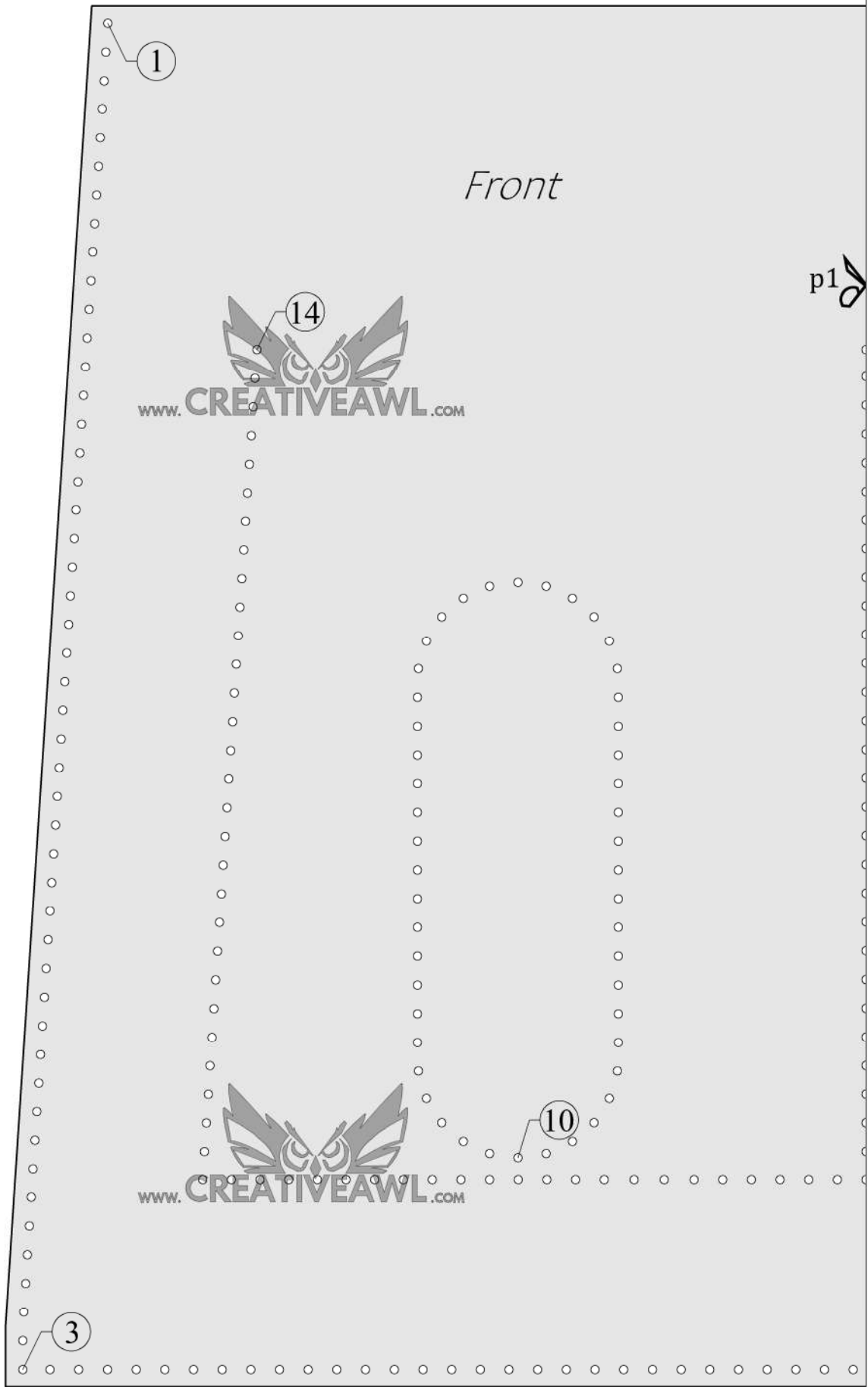

11 in
LETTER
8.5 in

A4

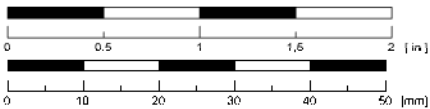

Chudley briefcase

Front

p1

2



11



4

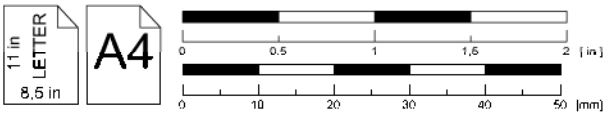

Chudley briefcase

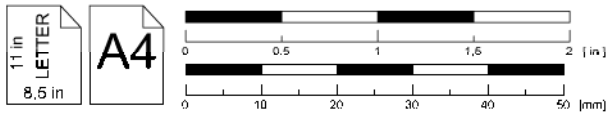
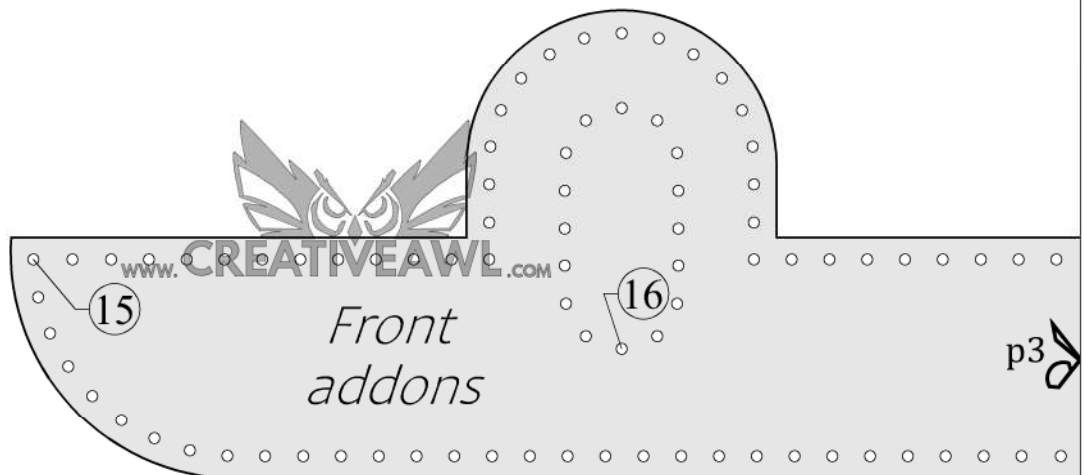
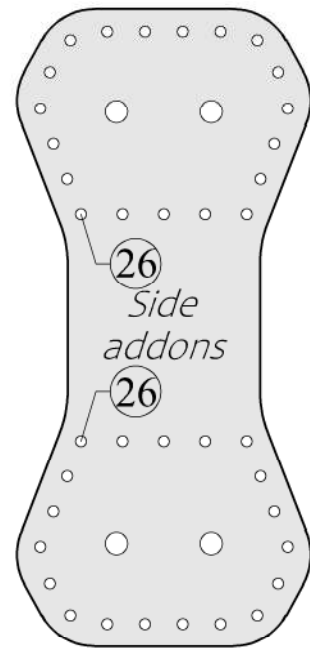
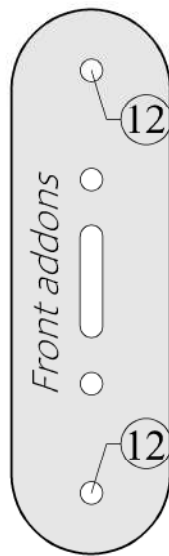
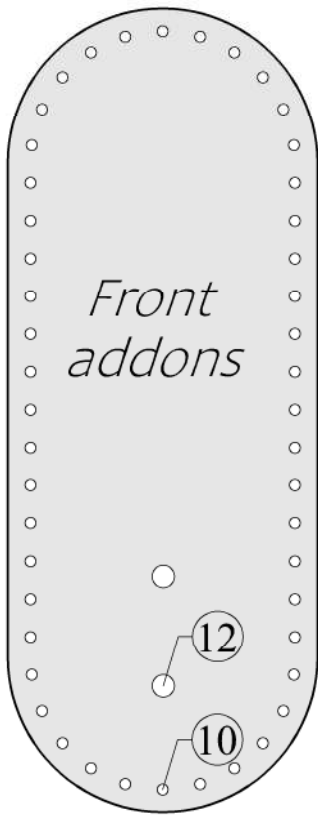
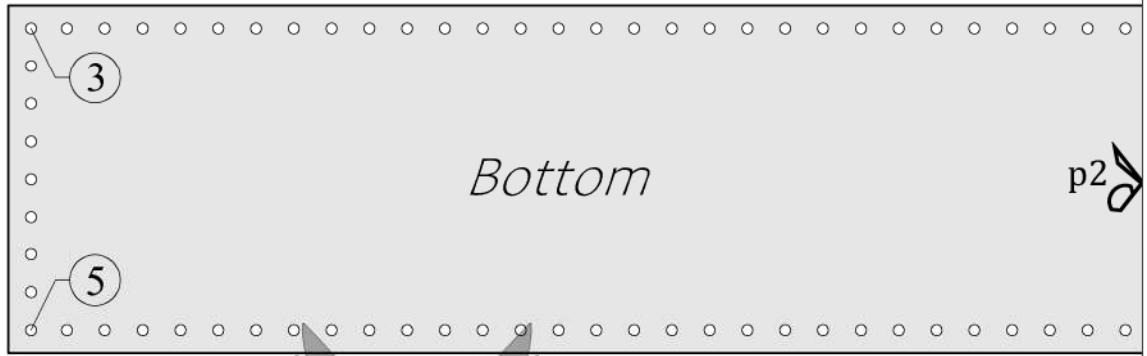

Chudley briefcase

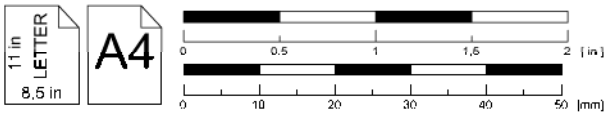
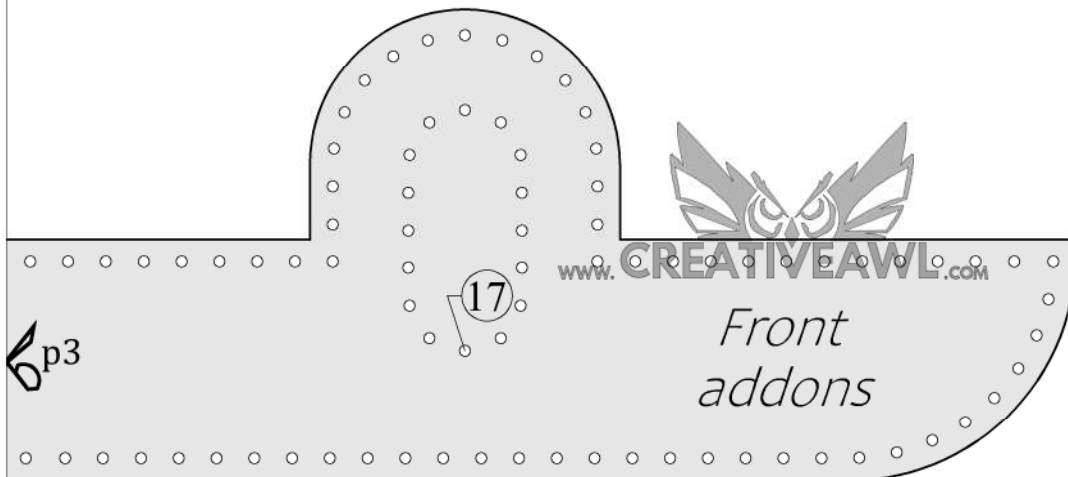
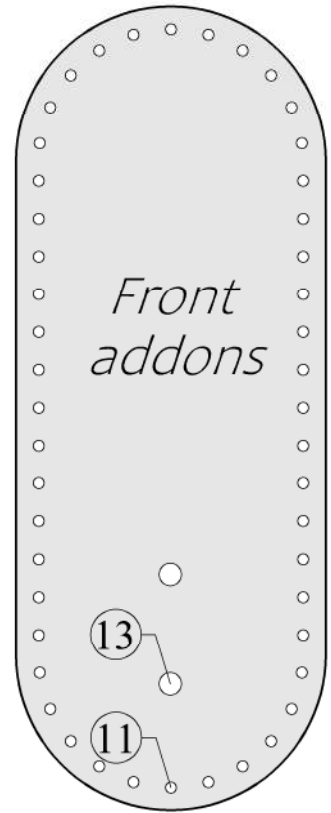
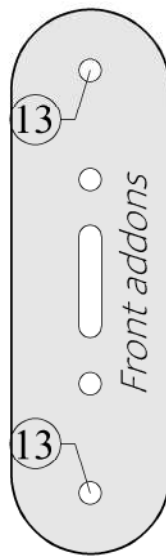
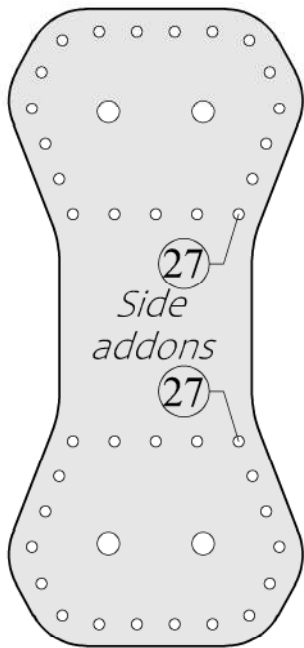

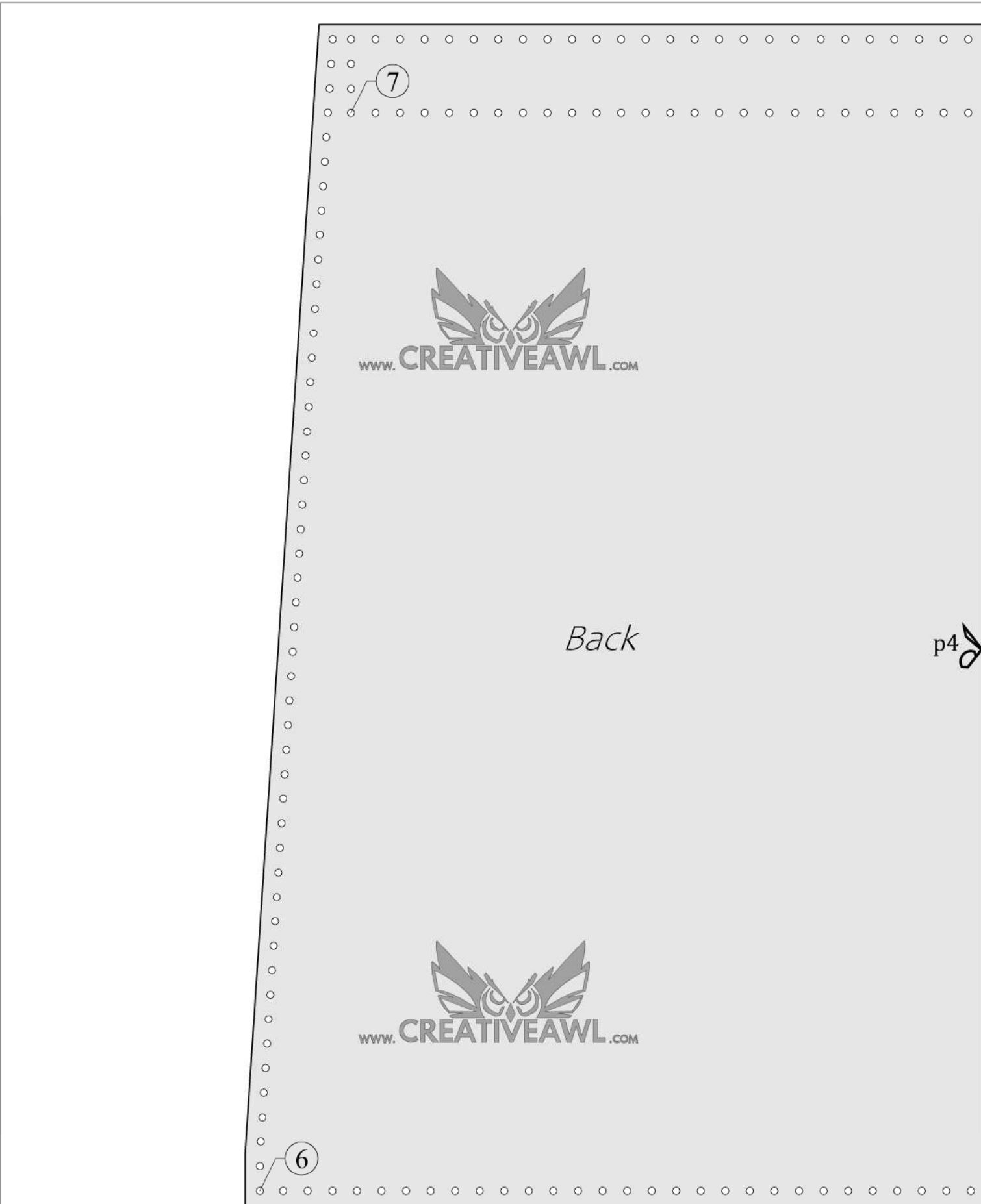

11 in
LETTER
8,5 in

A4

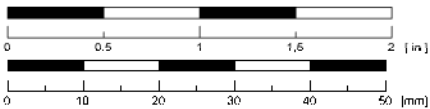

Chudley briefcase

10

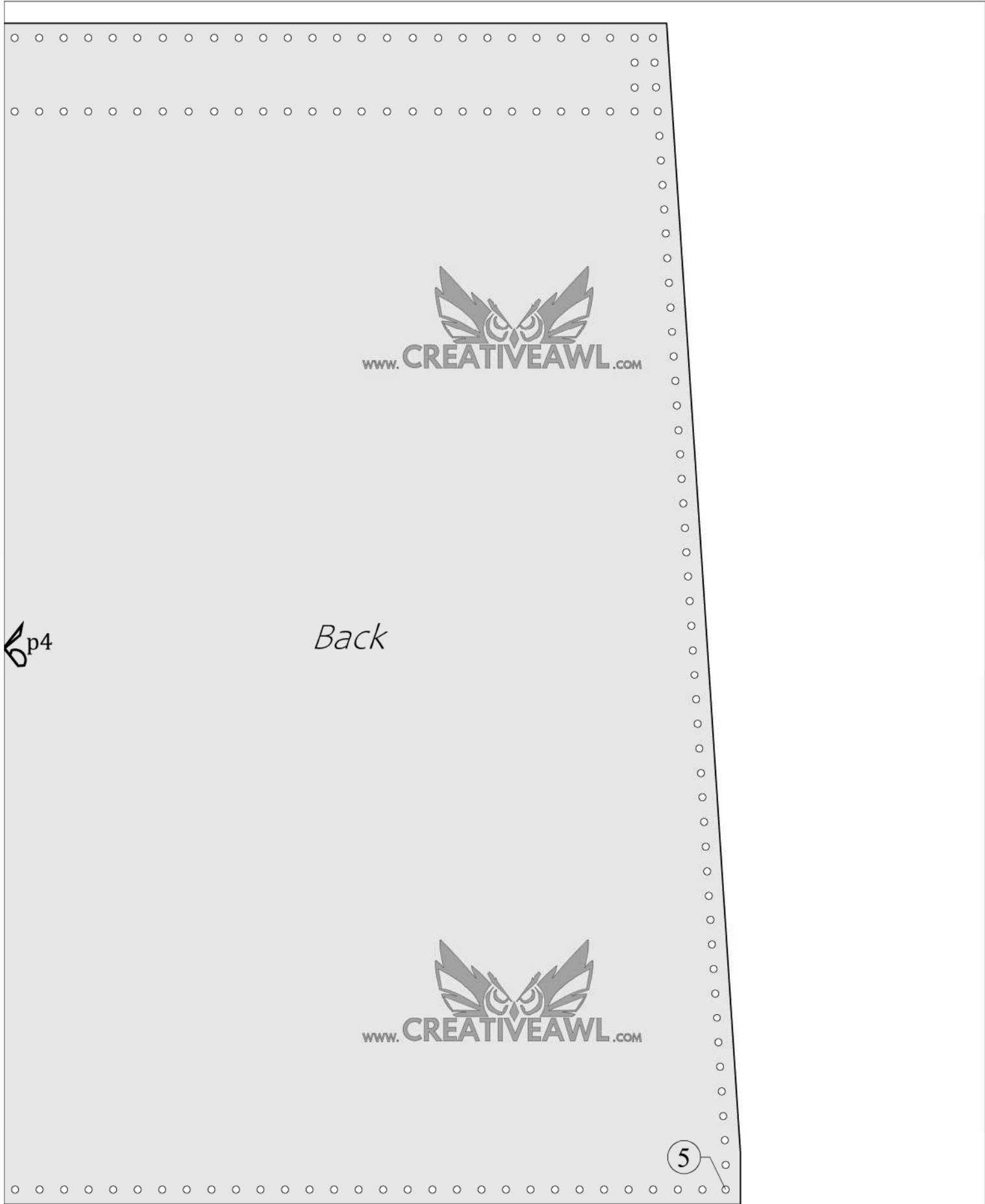

 p4

Back

5

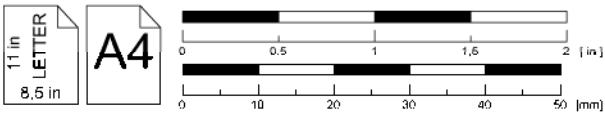

Chudley briefcase

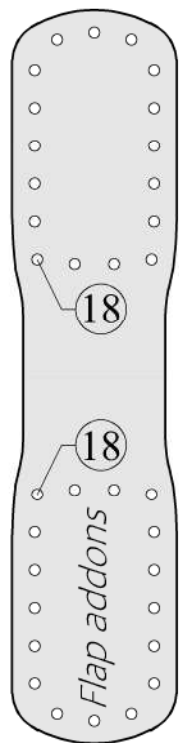
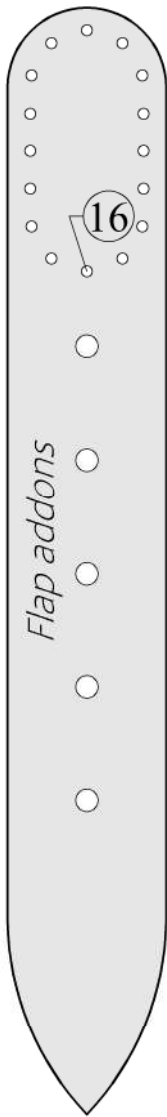

p5

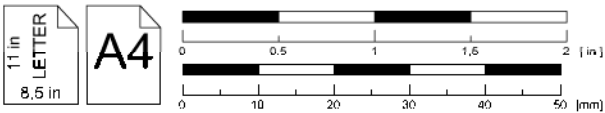

Chudley briefcase

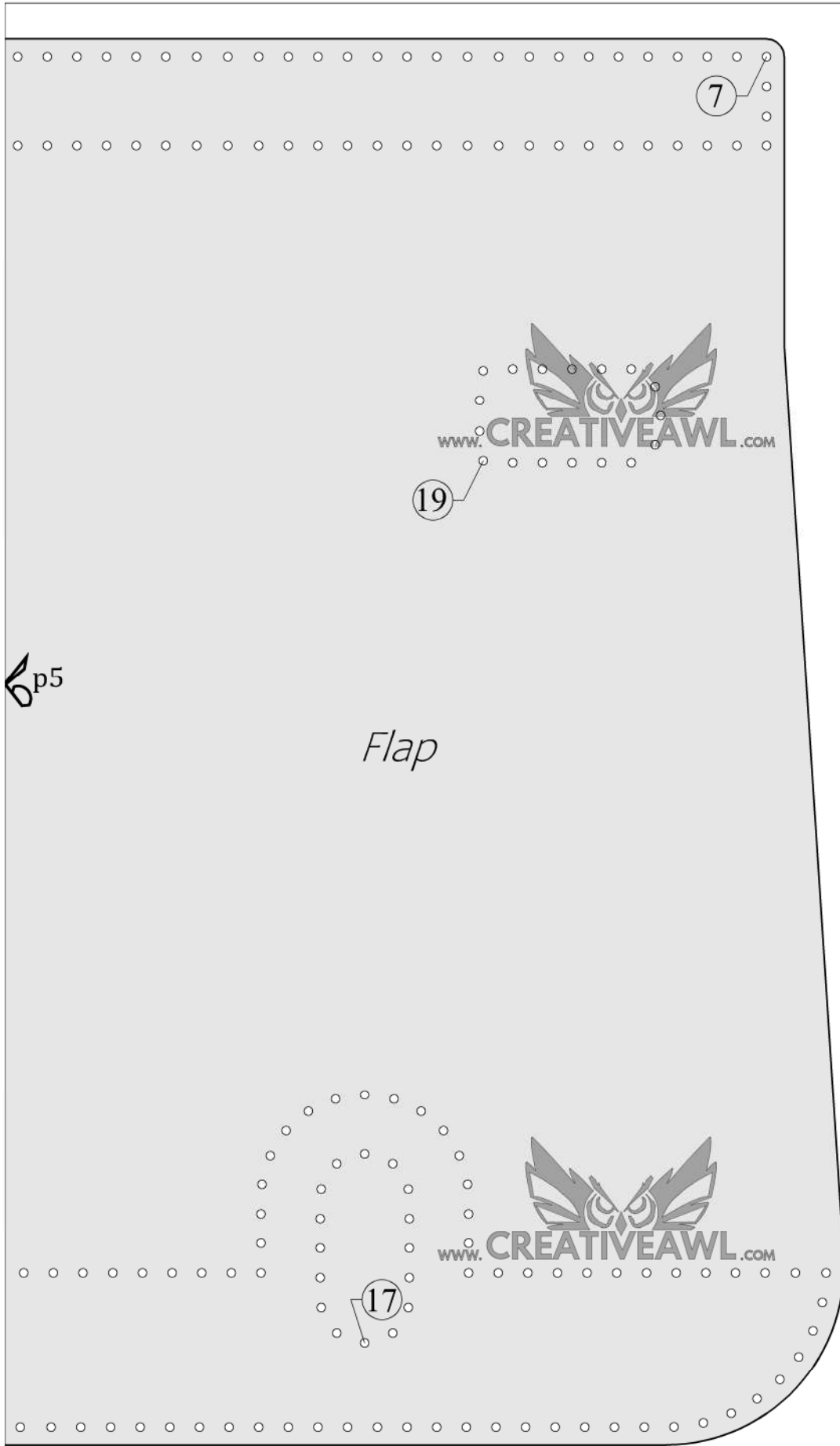

p5

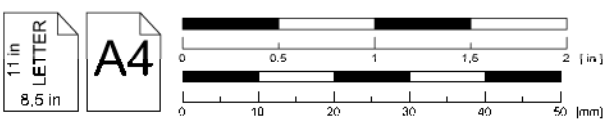
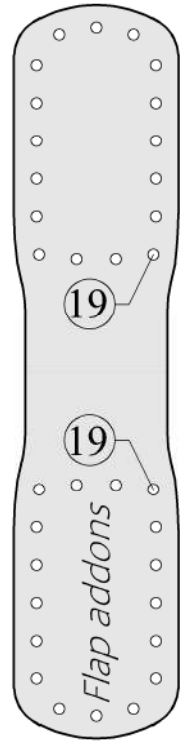
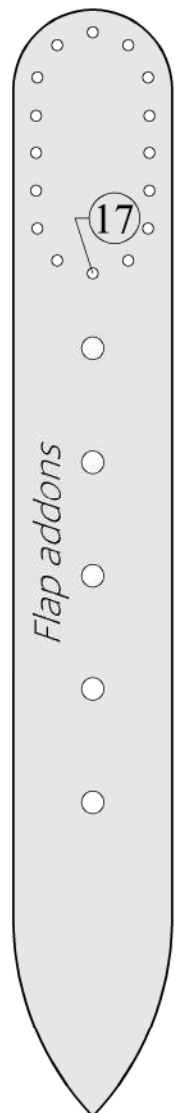

Chudley briefcase

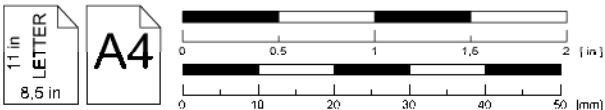
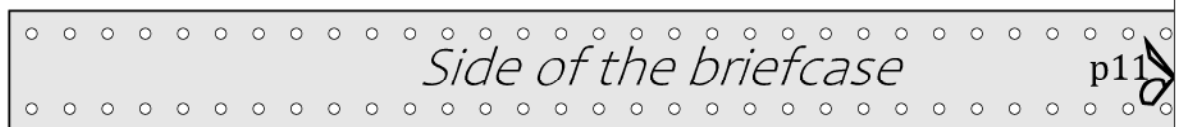
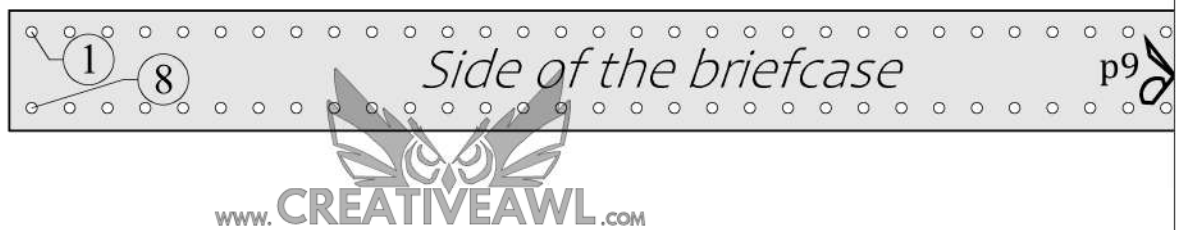
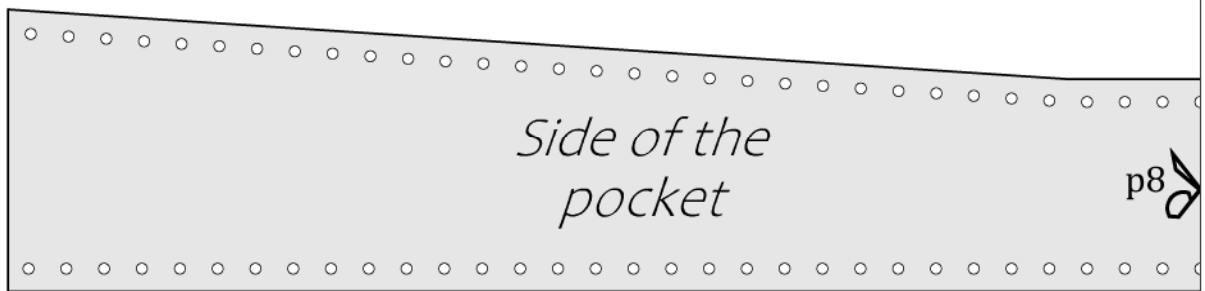

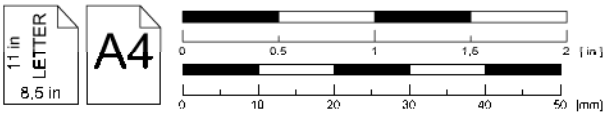
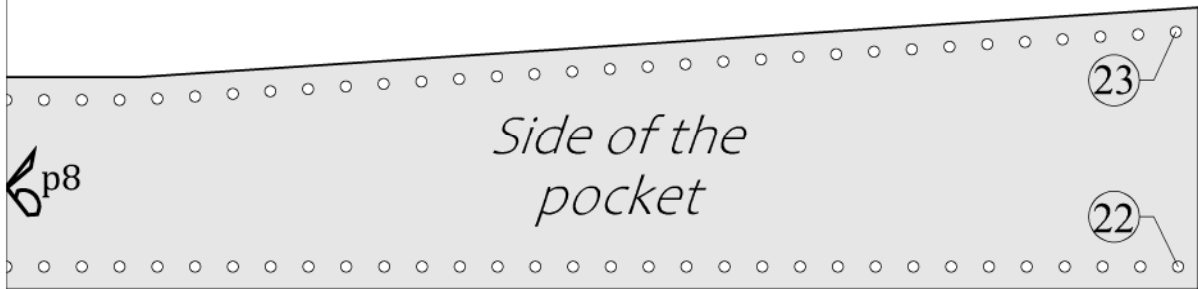
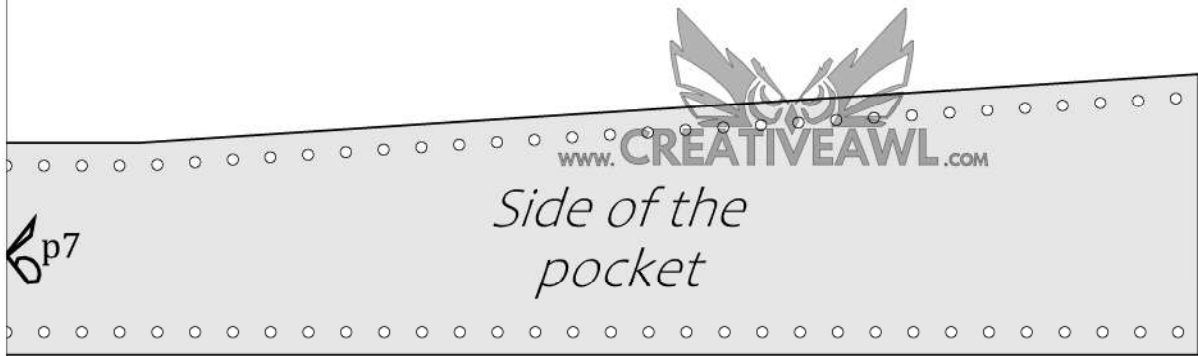

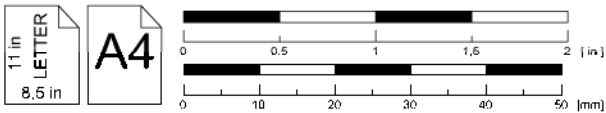

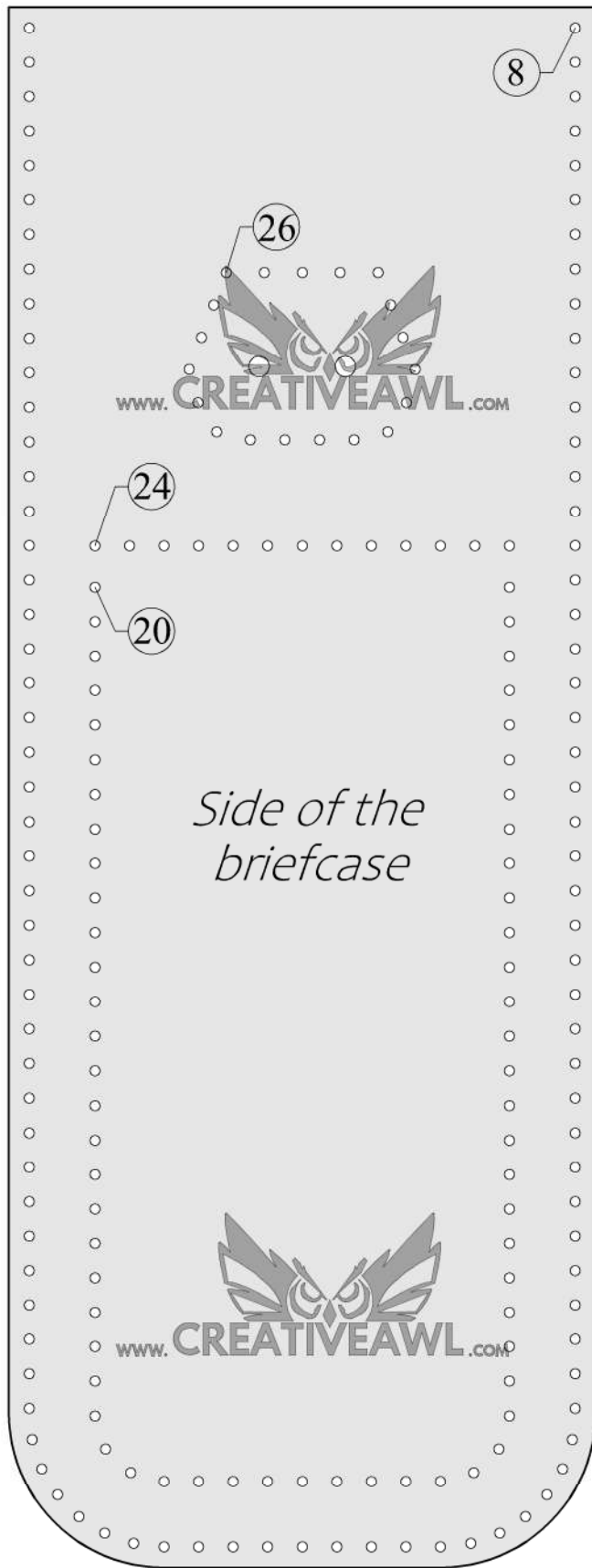

11 in
LETTER
8,5 in

A4

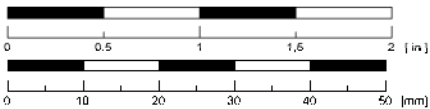

Chudley briefcase

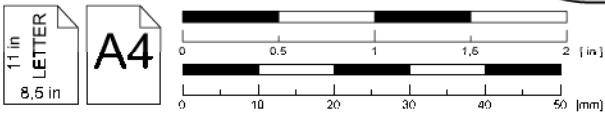

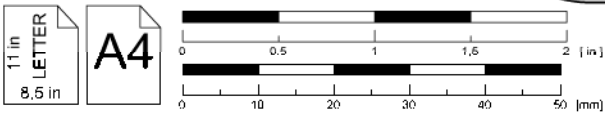

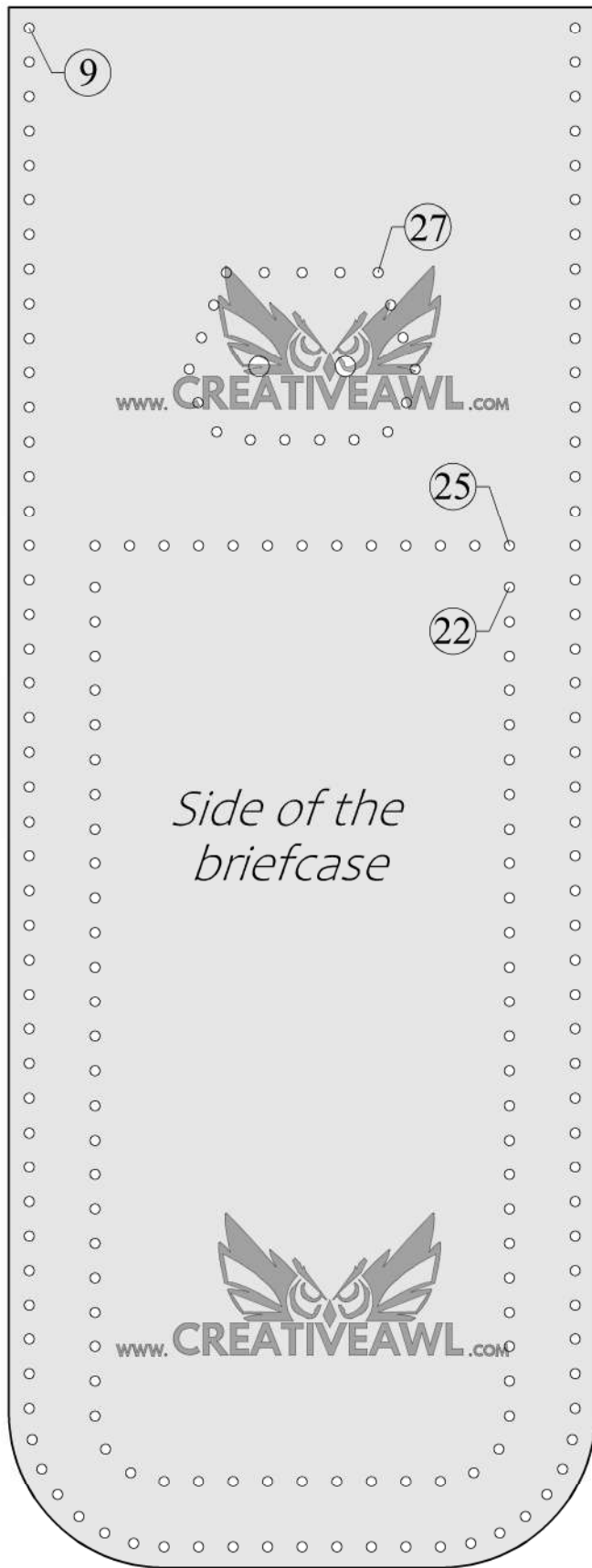



www.CREATIVEAWL.COM

Inside pocket

www.CREATIVEAWL.COM

14

11 in
LETTER
8,5 in

A4

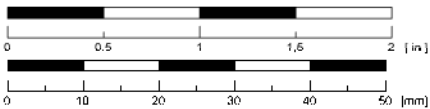

Chudley briefcase