

18,2 cm

# Test Page

©copyright www.dieselpunk.ro

Choose "actual size" in the printing preferences  
Make sure these dimensions are correct  
before starting your pattern

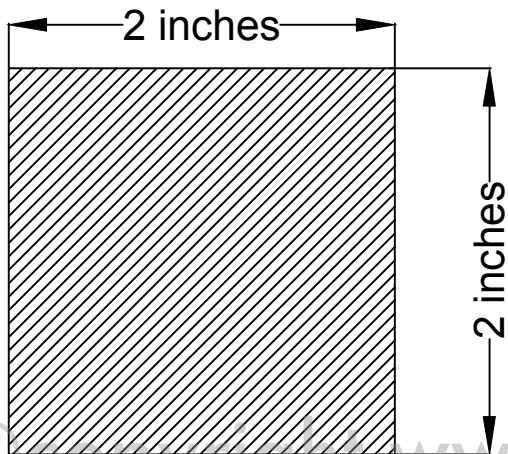
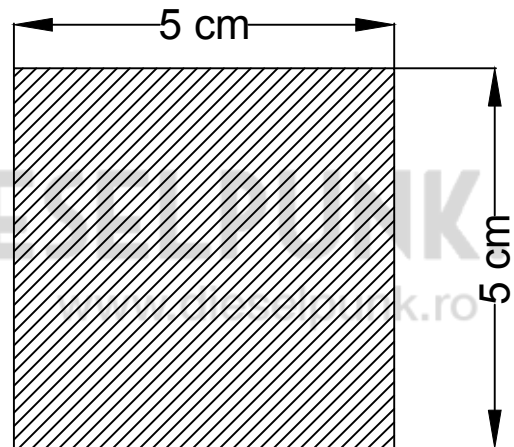

7,17 inches

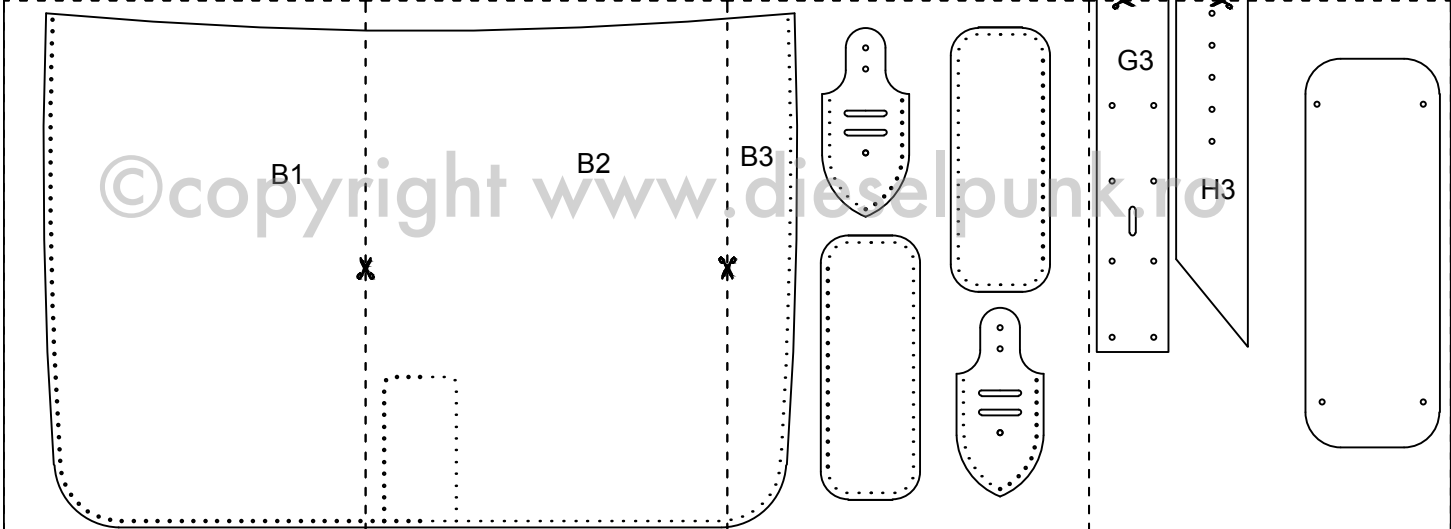
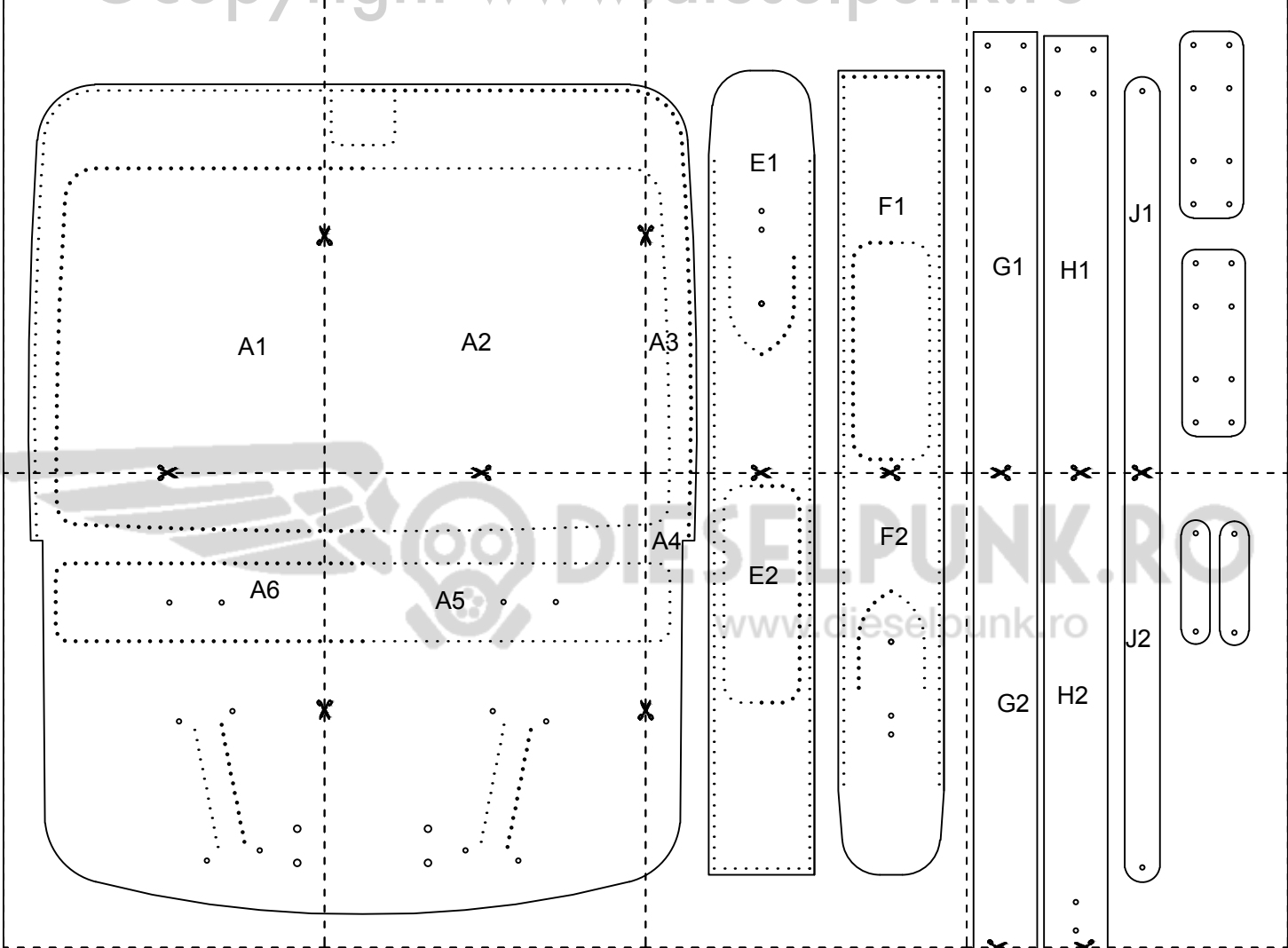
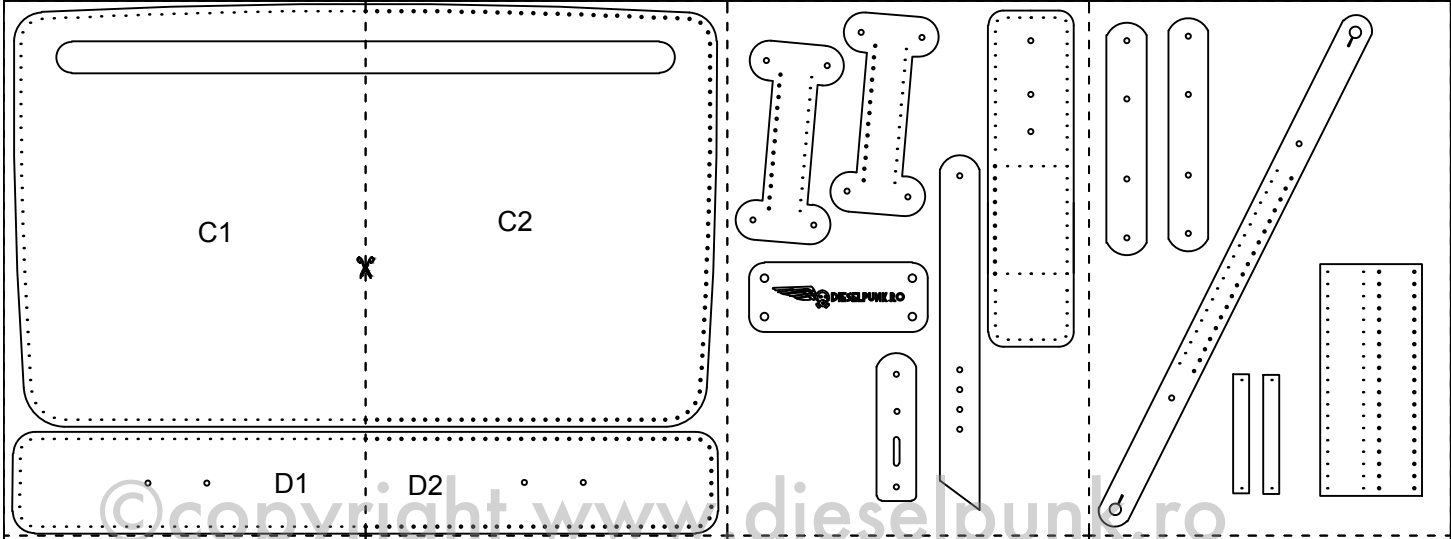

©copyright www.dieselpunk.ro

C1



©copyright www.dieselpunk.ro

D1

©copyright www.dieselpunk.ro

C2



©copyright www.dieselpunk.ro

D2

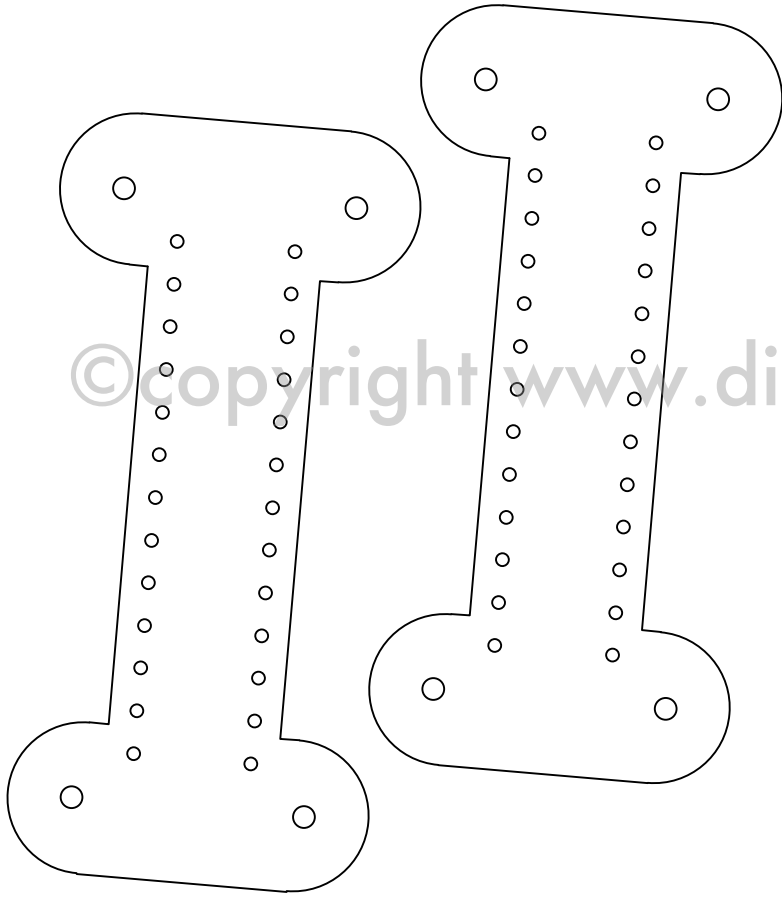

©copyright www.dieselpunk.ro

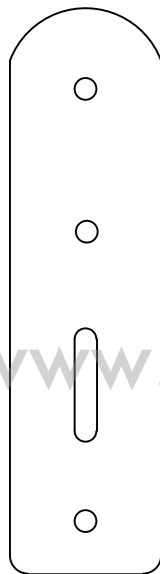
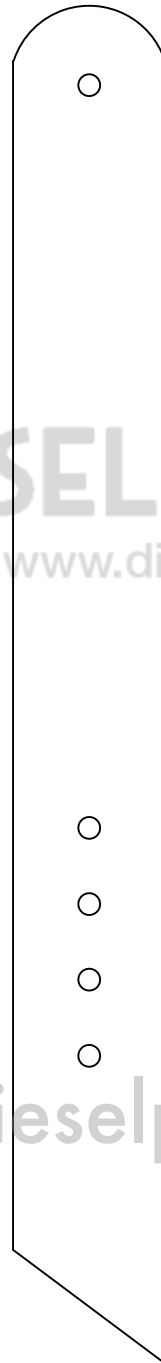
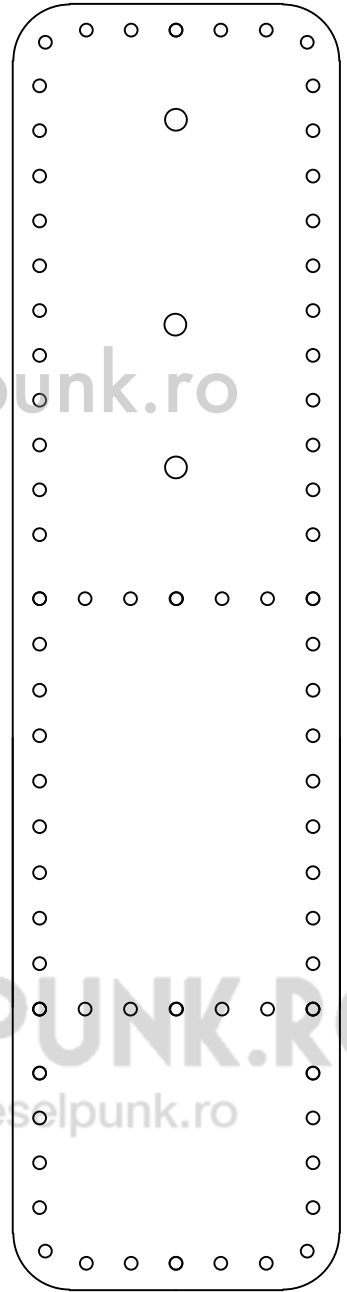
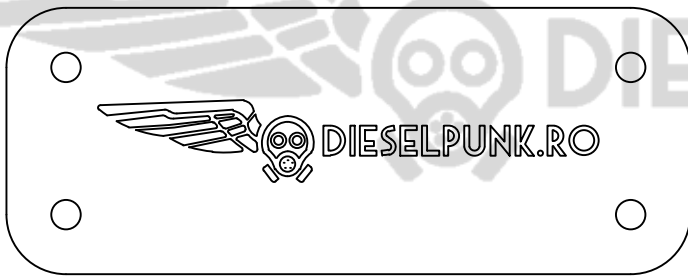

©copyright www.dieselpunk.ro

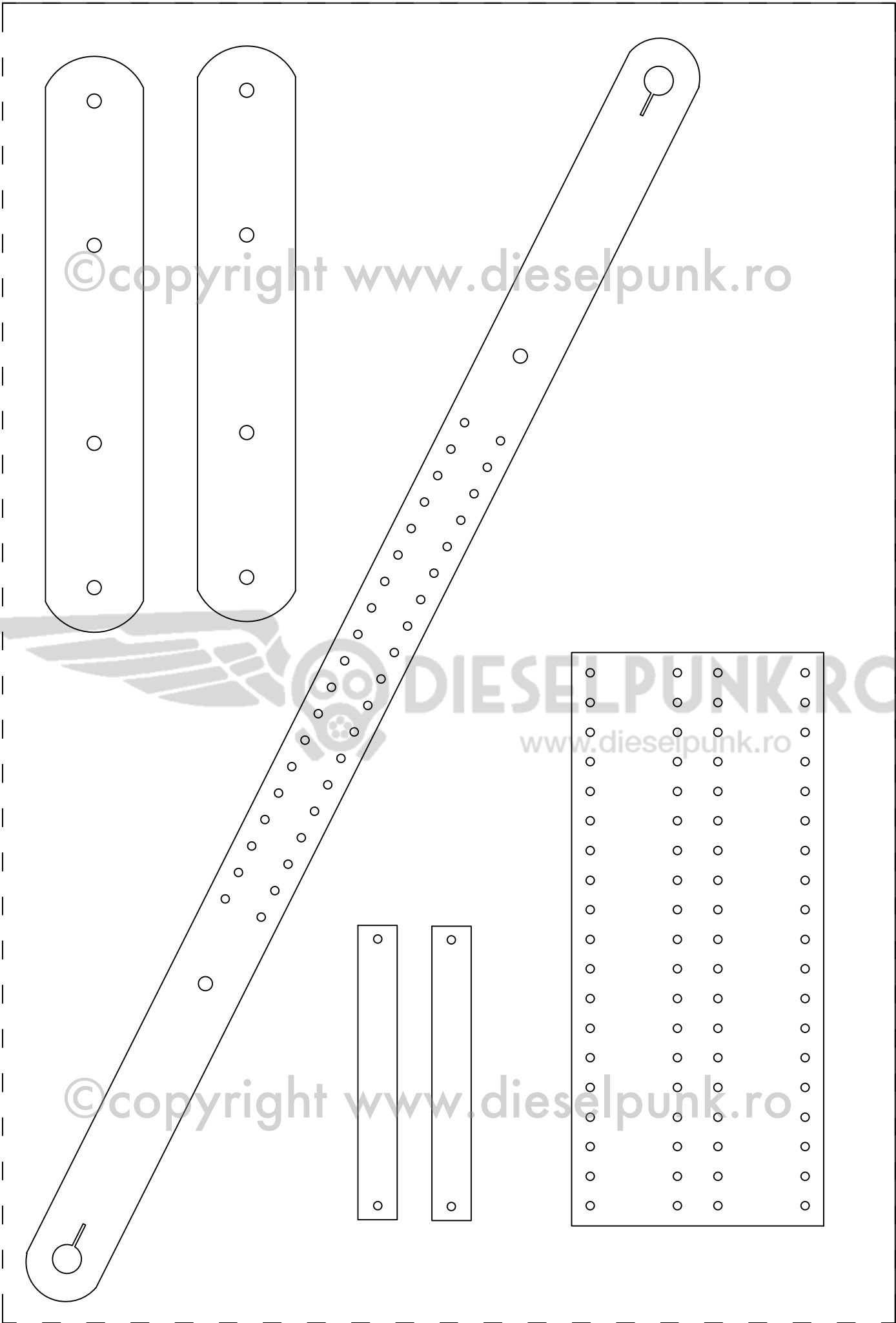

©copyright www.dieselpunk.ro

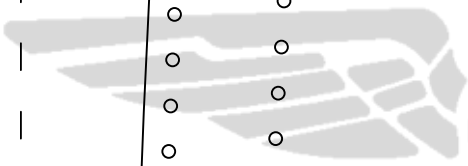

DIESELPUNK.RO

www.dieselpunk.ro

A1

©copyright www.dieselpunk.ro



©copyright www.dieselpunk.ro



A2

©copyright www.dieselpunk.ro





©copyright www.dieselpunk.ro

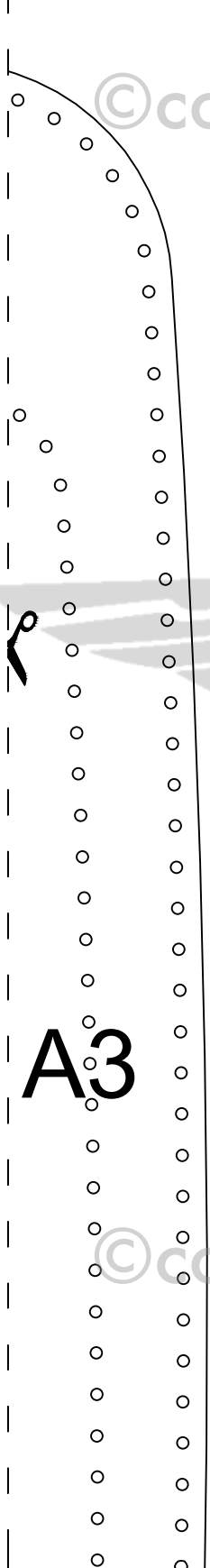

A3

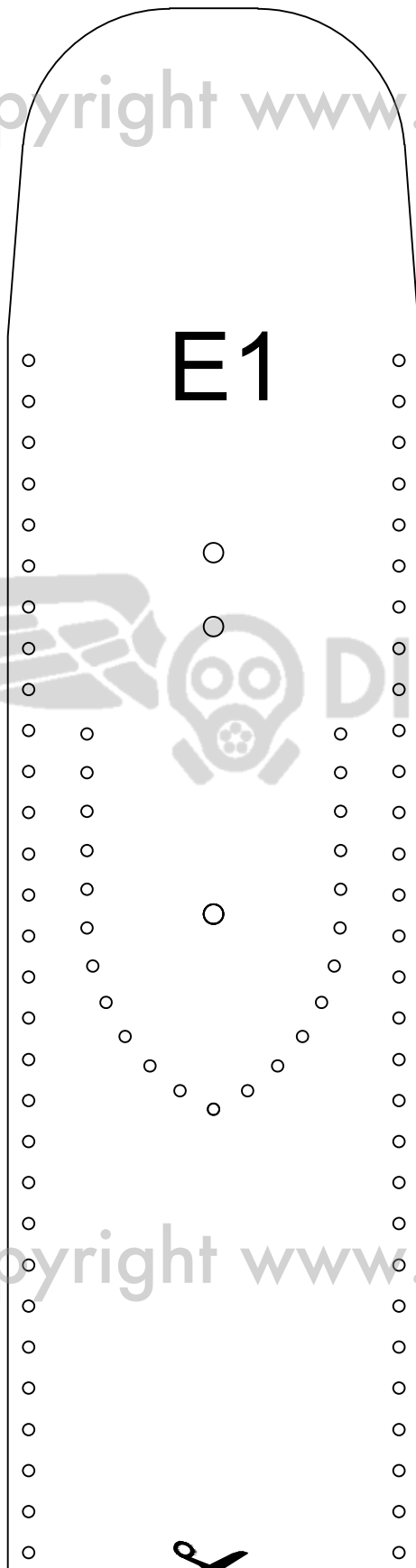

E1

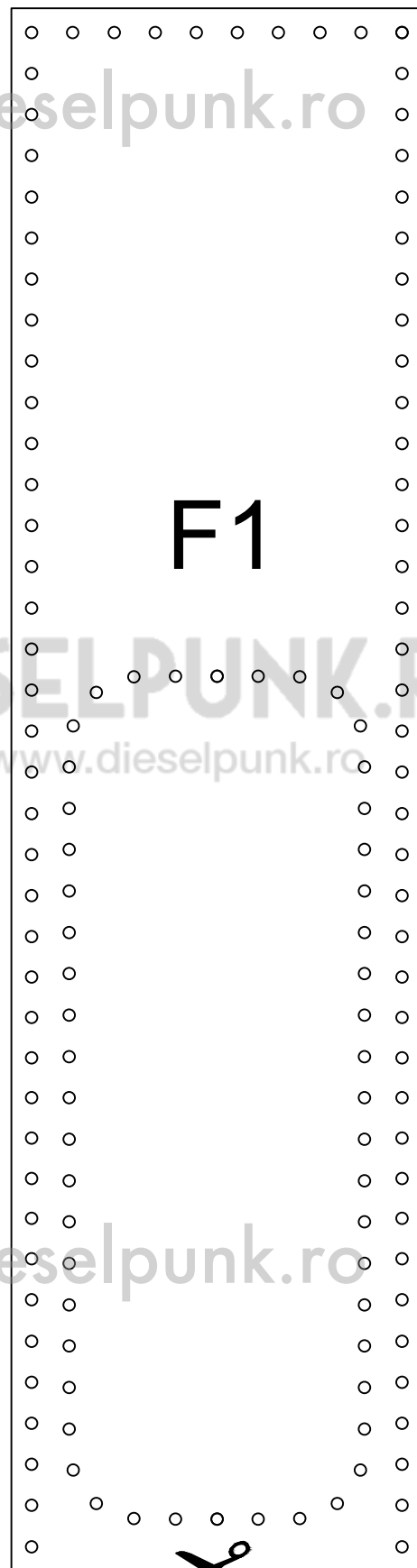

F1

©copyright www.dieselpunk.ro

DIESELPUNK.RO  
www.dieselpunk.ro

A4

E2

F2

©copyright www.dieselpunk.ro

DIESELPUNK.RO  
www.dieselpunk.ro

©copyright www.dieselpunk.ro

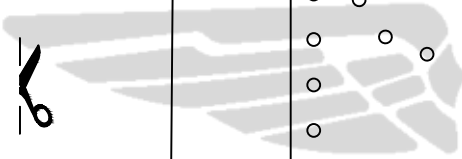

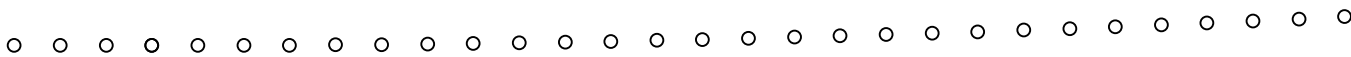

©copyright www.dieselpunk.ro

A5

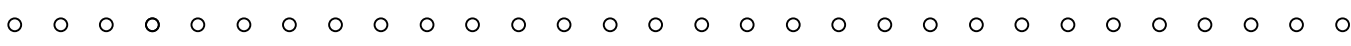

DIESELPUNK.RO

www.dieselpunk.ro

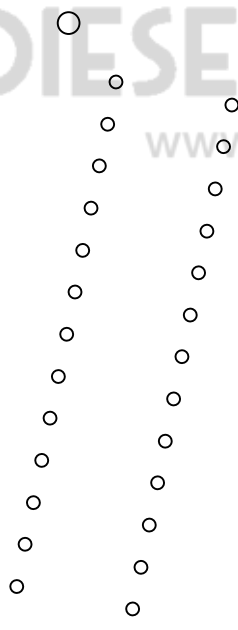

©copyright www.dieselpunk.ro





©copyright www.dieselpunk.ro

A6



©copyright www.dieselpunk.ro

©copyright www.dieselpunk.ro

**B1**



©copyright www.dieselpunk.ro

©copyright www.dieselpunk.ro

**B2**



©copyright www.dieselpunk.ro



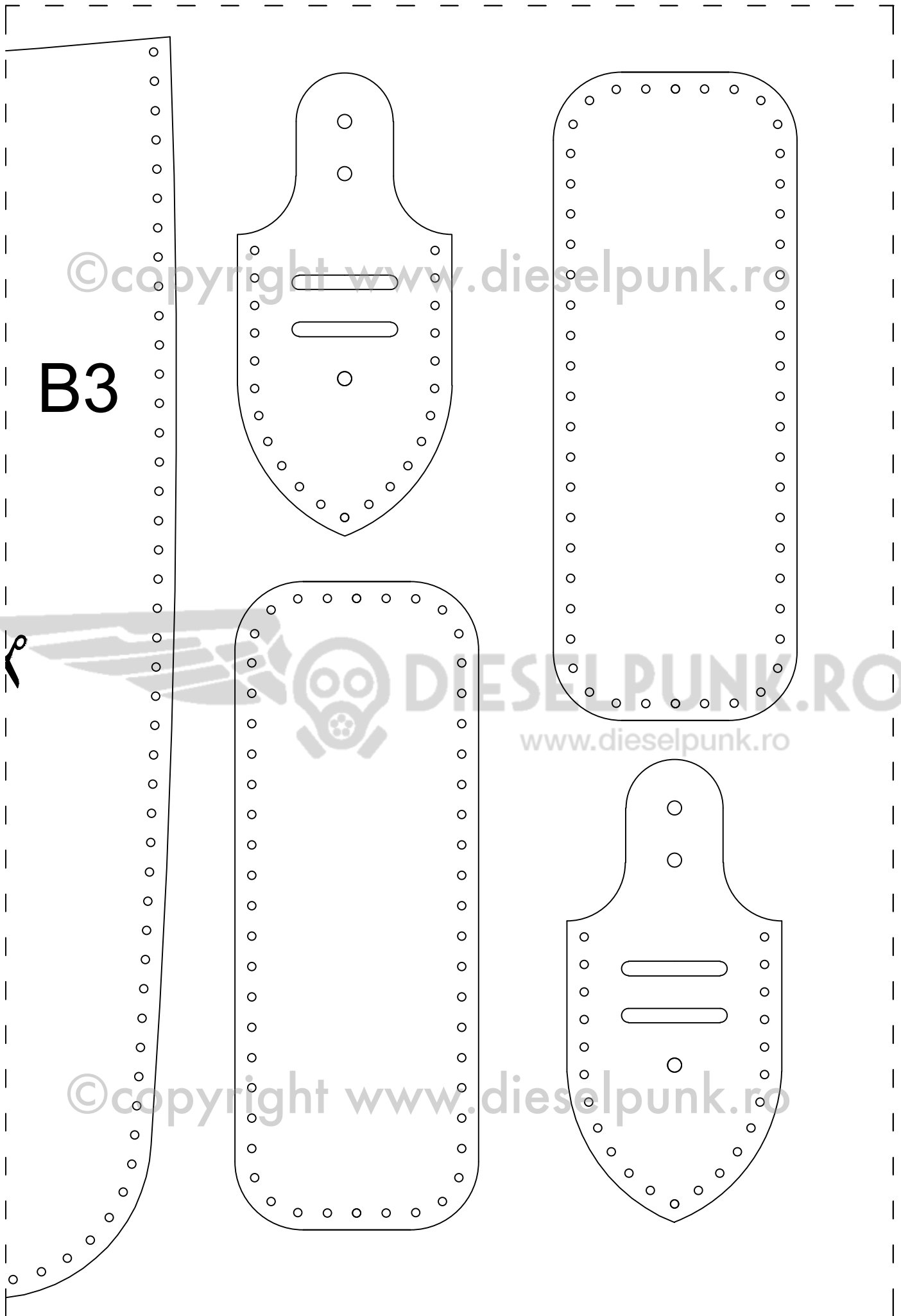

**B3**

©copyright www.dieselpunk.ro

**DIESELPUNK.RO**

www.dieselpunk.ro

©copyright www.dieselpunk.ro

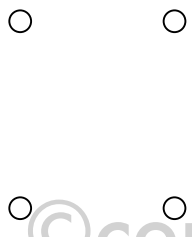

**G1**

©copyright www.dieselpunk.ro

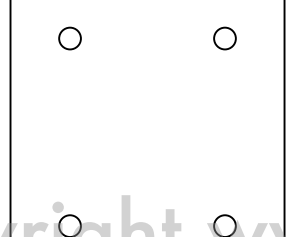

**H1**

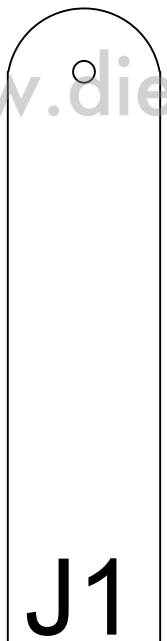

**J1**

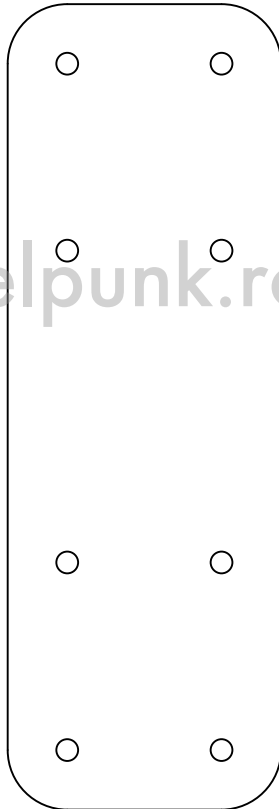

DIESELPUNK.RO  
www.dieselpunk.ro



©copyright www.dieselpunk.ro

G2

H2

J2

DIESELPUNK.RO  
www.dieselpunk.ro

©copyright www.dieselpunk.ro

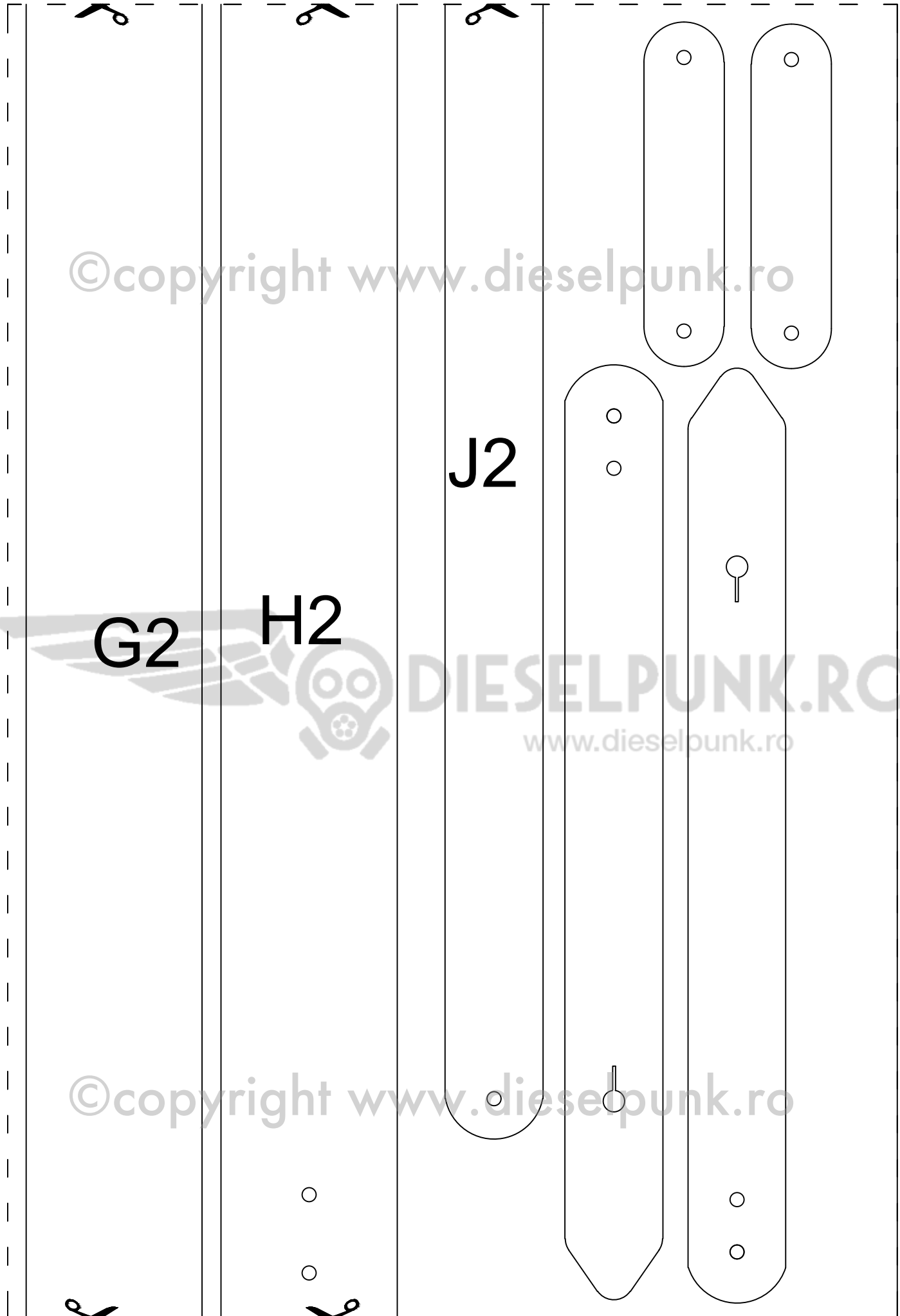

**G3**

**H3**

©copyright www.dieselpunk.ro

**DIESELPUNK.RO**

www.dieselpunk.ro

©copyright www.dieselpunk.ro

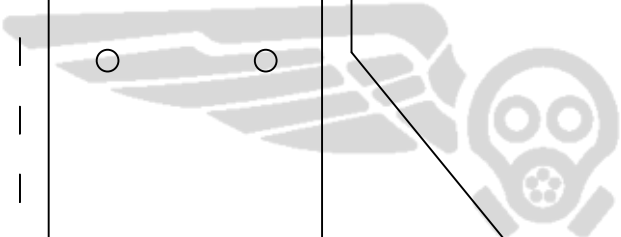

# Copyright Advisory

©copyright [www.dieselpunk.ro](http://www.dieselpunk.ro)

YOU CAN SELL any items made with my patterns on your own web site or in a brick and mortar shop, at conventions, fairs and so forth without any problem as long as you don't sell more than 10 of each design each year.

If you want to sell them on Etsy.com I will require you buy my pattern again each time you make a sale to cover my designer rights\*

\*Note that I do not police this rules and I only rely on the honor system to get the due credit.

However if I feel these rules are abused I may choose to take further action within the copyright and the DMCA international law

THESE PATTERNS ARE NOT TO BE  
RESOLD OR SHARED FOR FREE  
UNDER ANY CIRCUMSTANCES.