



CREATIVE AWL
**ORIGINAL
PATTERNS**



Rider Jacket



 **YouTube**
VIDEO TUTORIAL

**EASY TO
PRINT**
PDF >>>>
PATTERN

LET'S GO!

• & don't forget check out our free patterns!



1



PRINT THE PATTERN

- Open your pattern in Adobe Acrobat Reader, or any web browser.
- Every page has a measure - check does it fit.
- Every printed page **MUST HAVE** a border around! If doesn't - move paper left/ right and print again

2



FOLLOW VIDEO INSTRUCTIONS

- Video tutorial:
<https://youtu.be/A0JjNI9eLYU>
- Cutting patterns:
https://www.youtube.com/watch?v=2TNUI_TIk64



3



GIVE A SMILE TO OTHER PEOPLE !

- Give a ready product to you family or friend.
Give them a smile :)))
- Also Check www.CreativeAwl.com for more patterns

4



JOIN OUR FB GROUP

- Go there to share your work. Also get more DIY&ideas. We will support you & answer all questions.
<https://www.facebook.com/groups/CreativeAwlPatterns/>



YOU NEED

MATERIALS

- 2.4 - 2.8 SQM (29 - 31SQFT) 1-1.2MM (2.5-3OZ) SOFT LEATHER
- SNAP BUTTONS
- 4X 20MM BUCKLES
- 2 X 15.5 CM ZIPPERS'
- 2 X 15 CM ZIPPERS
- MAIN ZIPPER:
 - M 52CM, L 54 CM, XL 56CM, XXL 58 CM

TOOLS

- SHARP KNIFE
- 1.2 - 1.5 MM HOLE PUNCHER / PRICKING IRONS OR AWL
- HAMMER
- 2 NEEDLES
- PAPER TAPE
- A HOME PRINTER

SHARE YOUR WORK

[https://www.facebook.com/groups/](https://www.facebook.com/groups/CreativeAwlPatterns)

CreativeAwlPatterns

Ranger jacket - size L:

pages 4 - 79

-The number in the circle shows which holes are to be connected. Example: ①

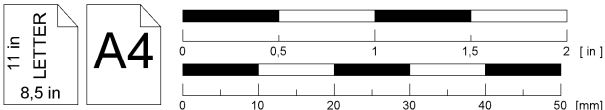
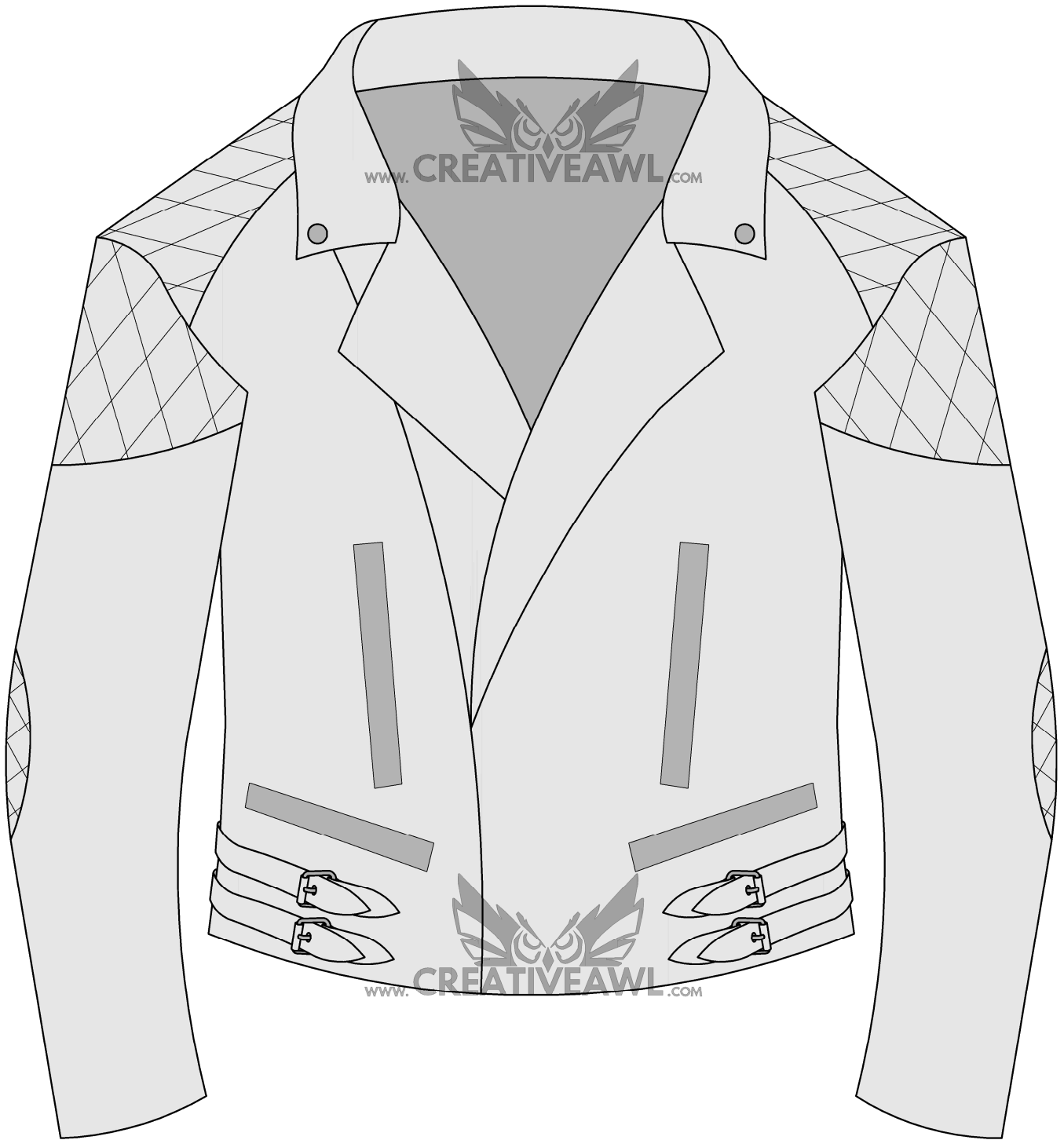

Sketch drawing

Leather needed for a Ranger jacket size L: about 2.50 m²

1370 mm (54.8 in)

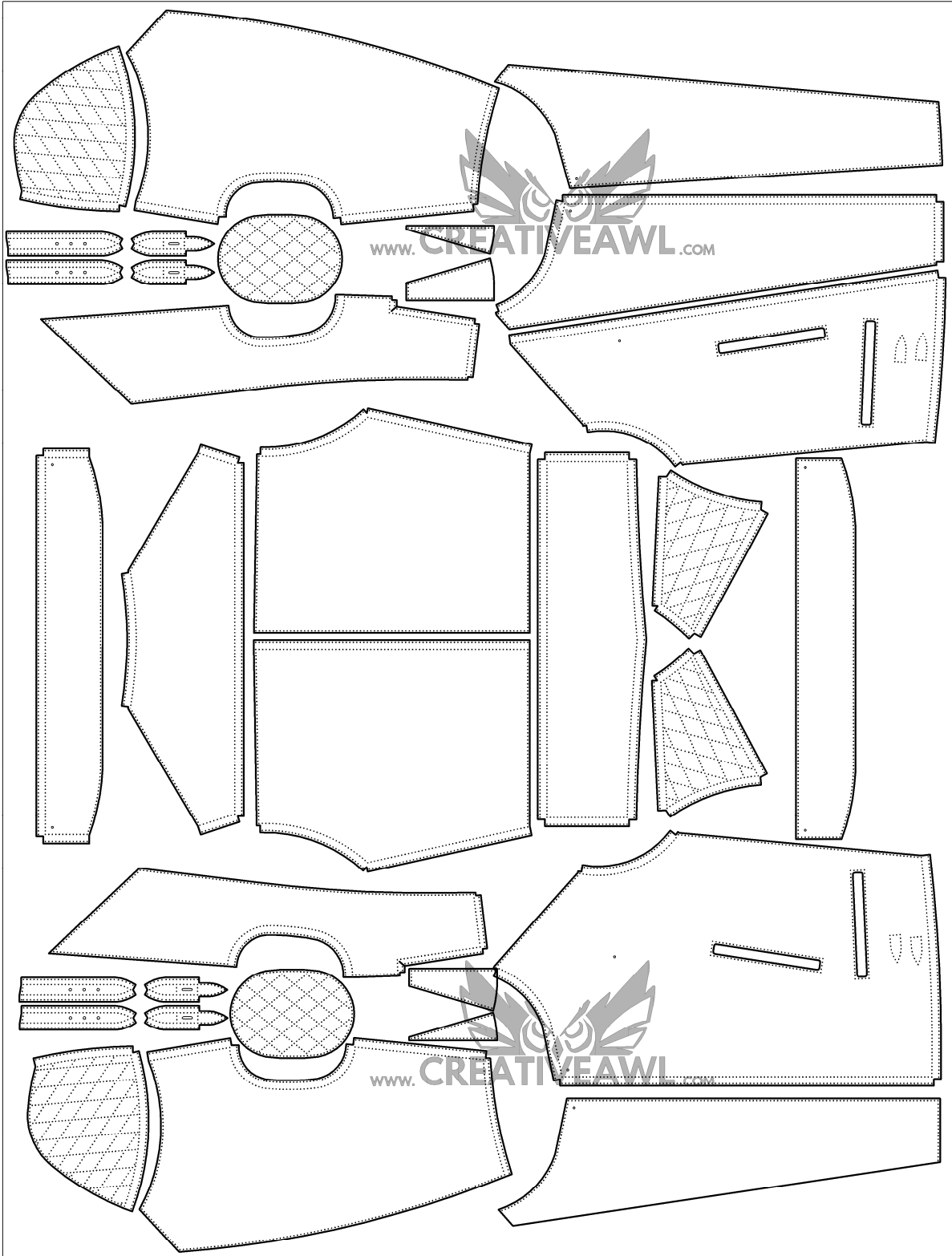

1800 mm (72 in)

Sketch drawing
Bill of materials

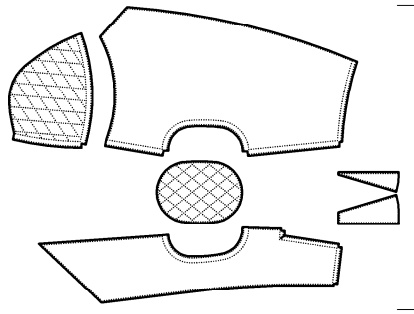

right sleeve

right shoulder

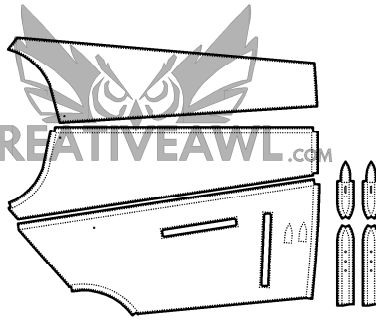
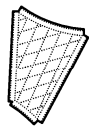

right front

collar

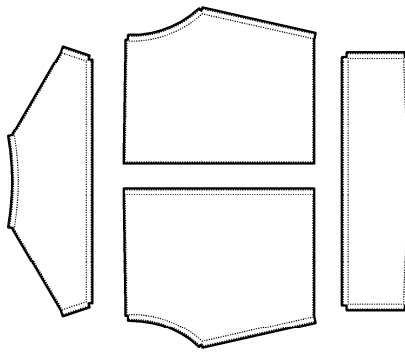
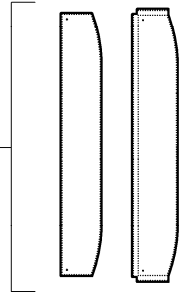

back

left shoulder

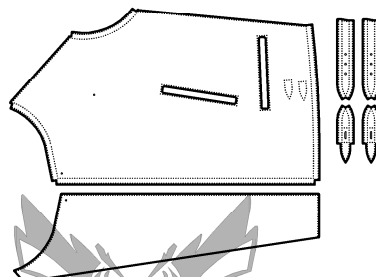
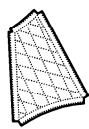

left front

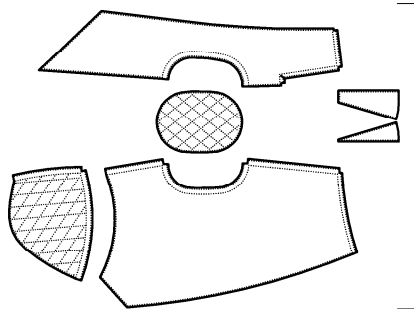

left sleeve

www.CREATIVEAWL.com

www.CREATIVEAWL.com

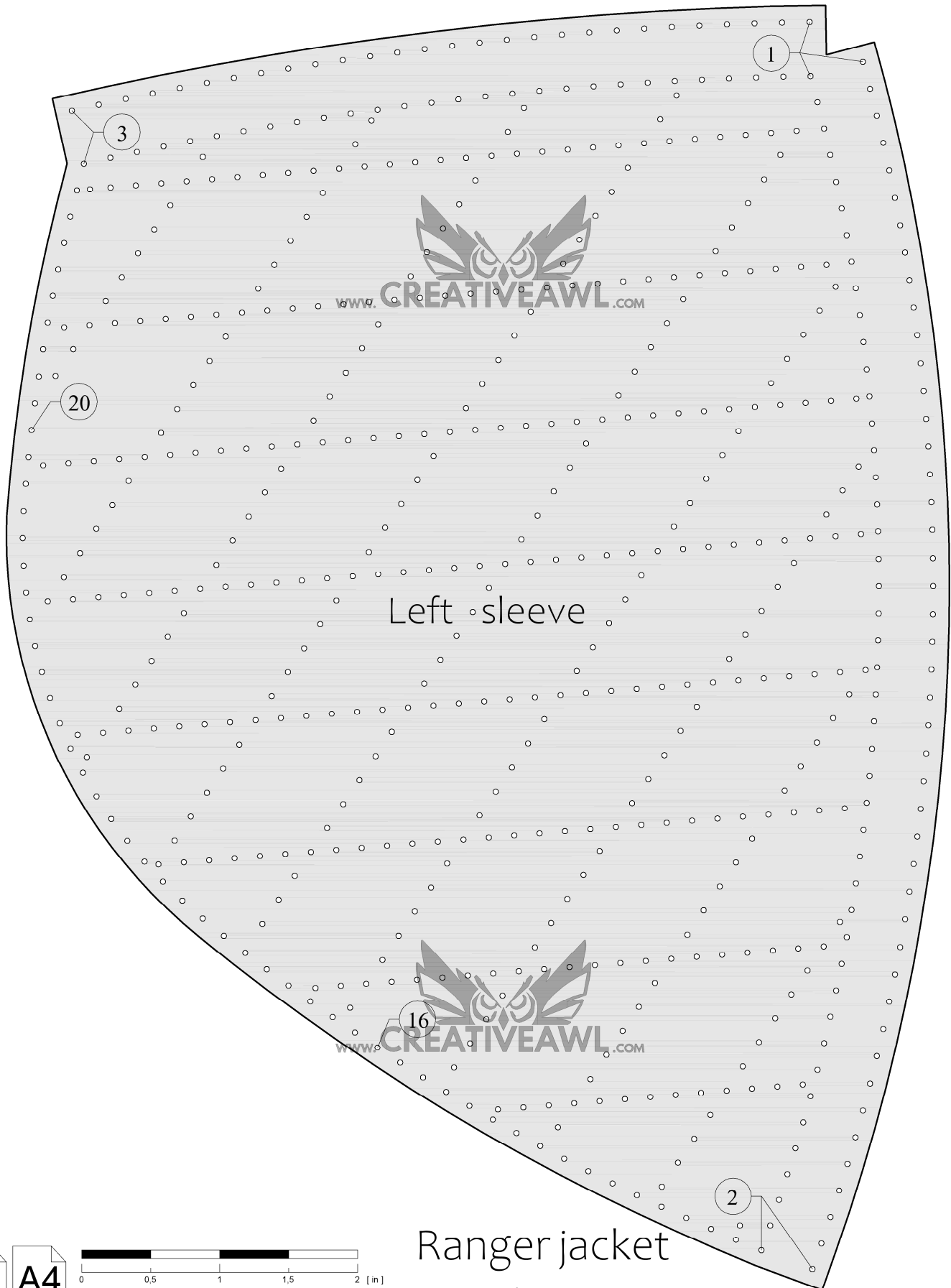

Left sleeve

Ranger jacket
- size L -

11 in
8,5 in

A4

0 0,5 1 1,5 2 [in]

0 10 20 30 40 50 [mm]

11 in
LETTER
8,5 in

A4

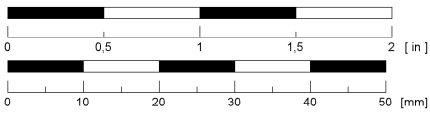

Ranger jacket - size L -

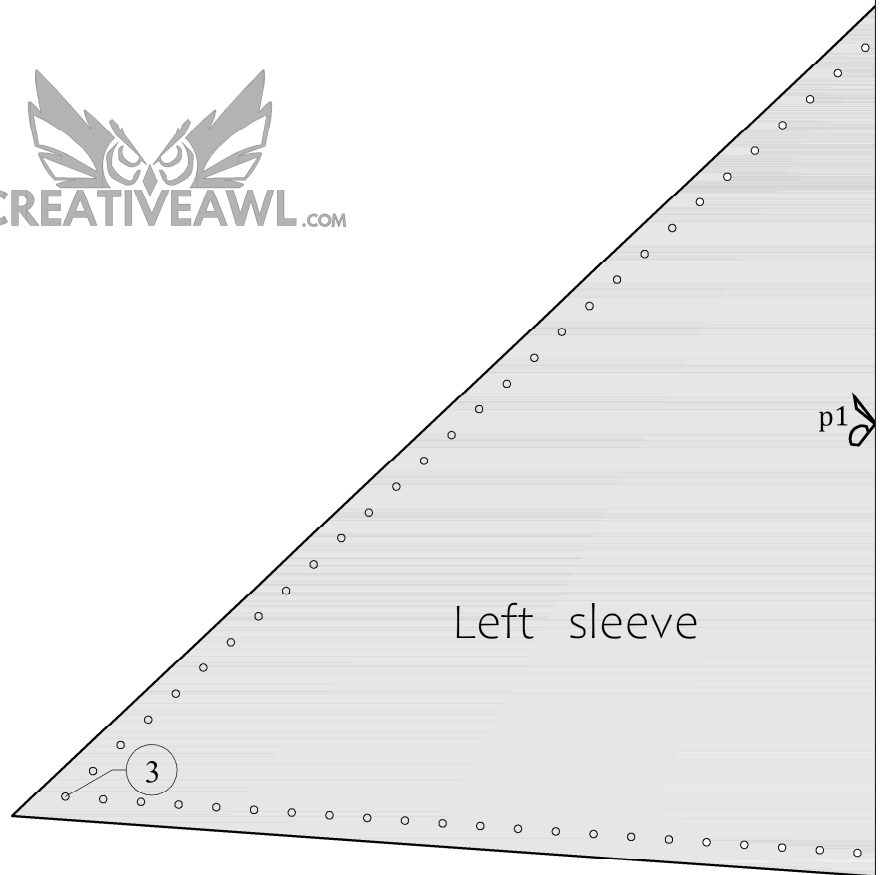

11 in
LETTER
8,5 in

A4

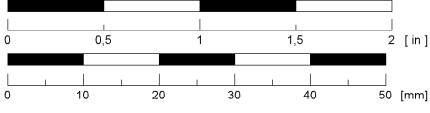

Ranger jacket - size L -

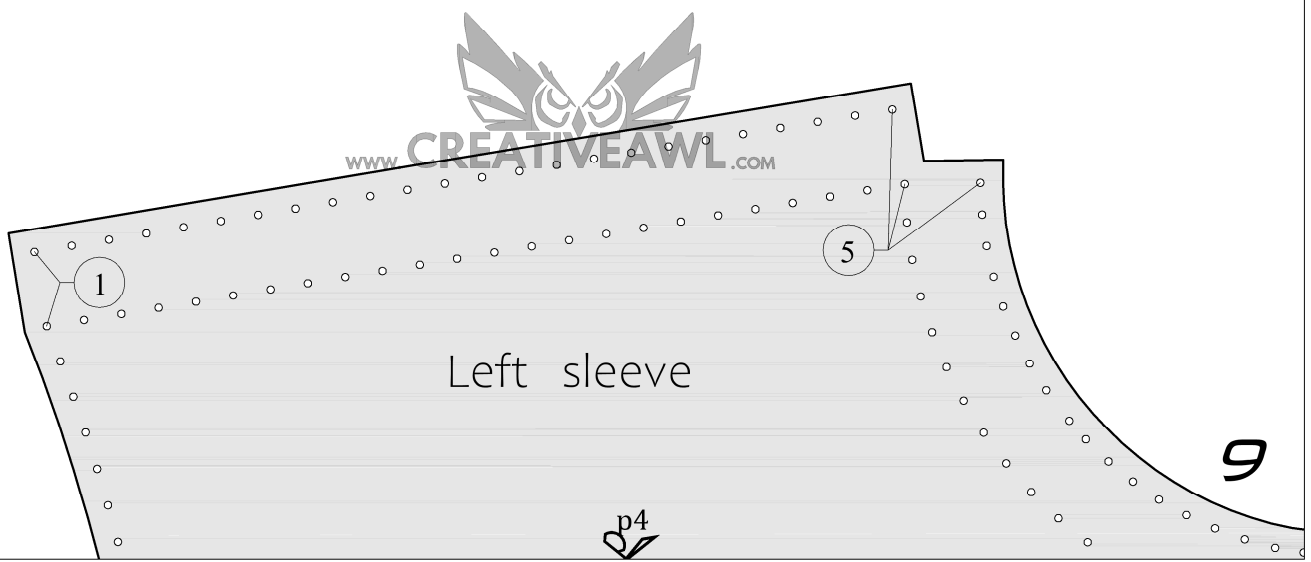

11 in
LETTER
8,5 in

A4

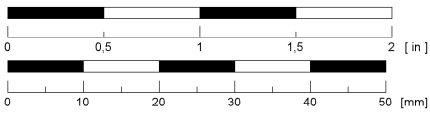

Ranger jacket - size L -

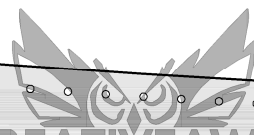

www.CREATIVEAWL.COM

p2

Left sleeve

p3

6



www.CREATIVEAWL.COM

6

Left sleeve

p6

p5

11 in
LETTER
8,5 in

A4

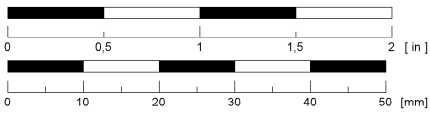

Ranger jacket - size L -

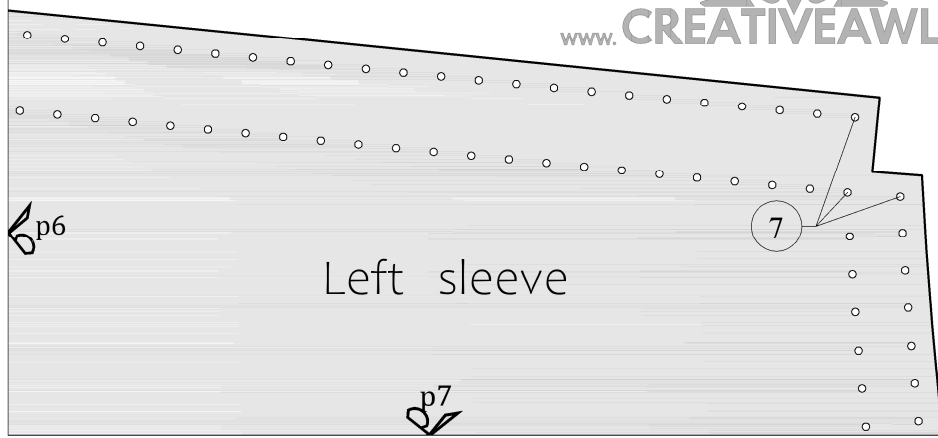
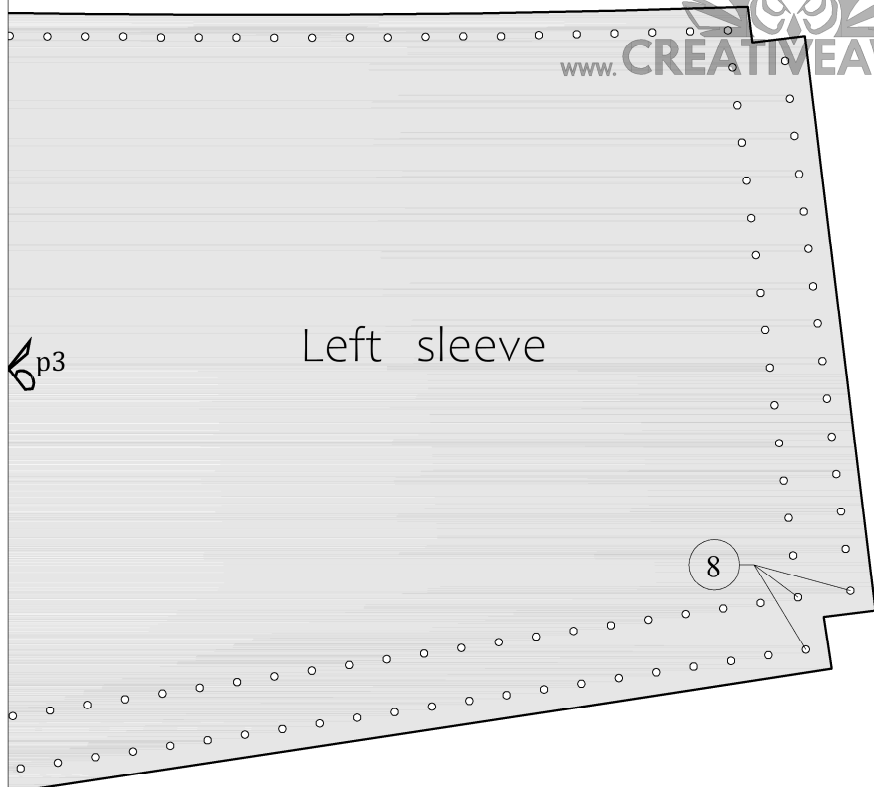



Left sleeve

11 in
LETTER
8,5 in

A4

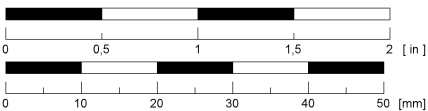

Ranger jacket
- size L -

p4

p8



Left sleeve



2

4

11 in
LETTER
8,5 in

A4

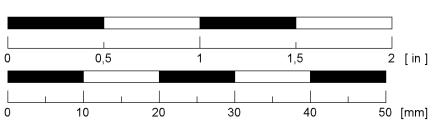

Ranger jacket
- size L -

p5



p9

p8

Left sleeve



11 in
LETTER
8,5 in

A4

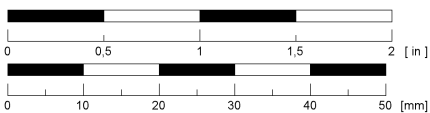

Ranger jacket
- size L -

p7



www.CREATIVEAWL.COM

Left sleeve

p9



www.CREATIVEAWL.COM

11 in
LETTER
8,5 in

A4

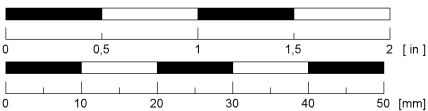

Ranger jacket
- size L -

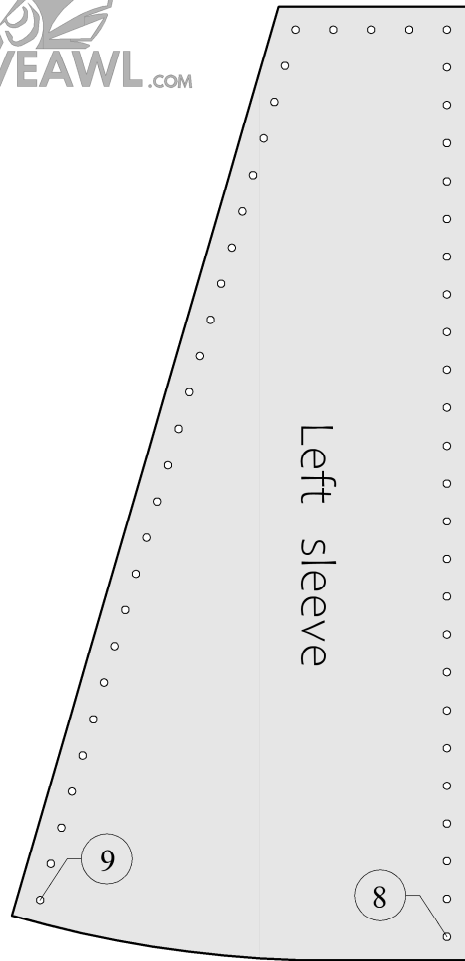
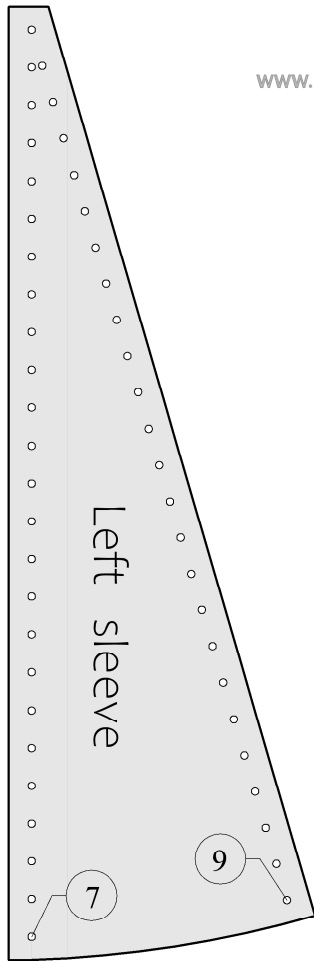

Left sleeve

Ranger jacket
- size L -

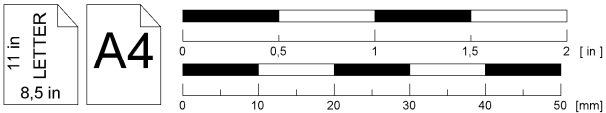

11 in
LETTER
8,5 in

A4

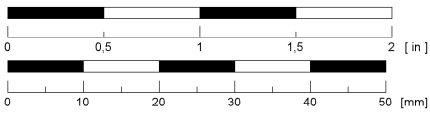

Ranger jacket - size L -

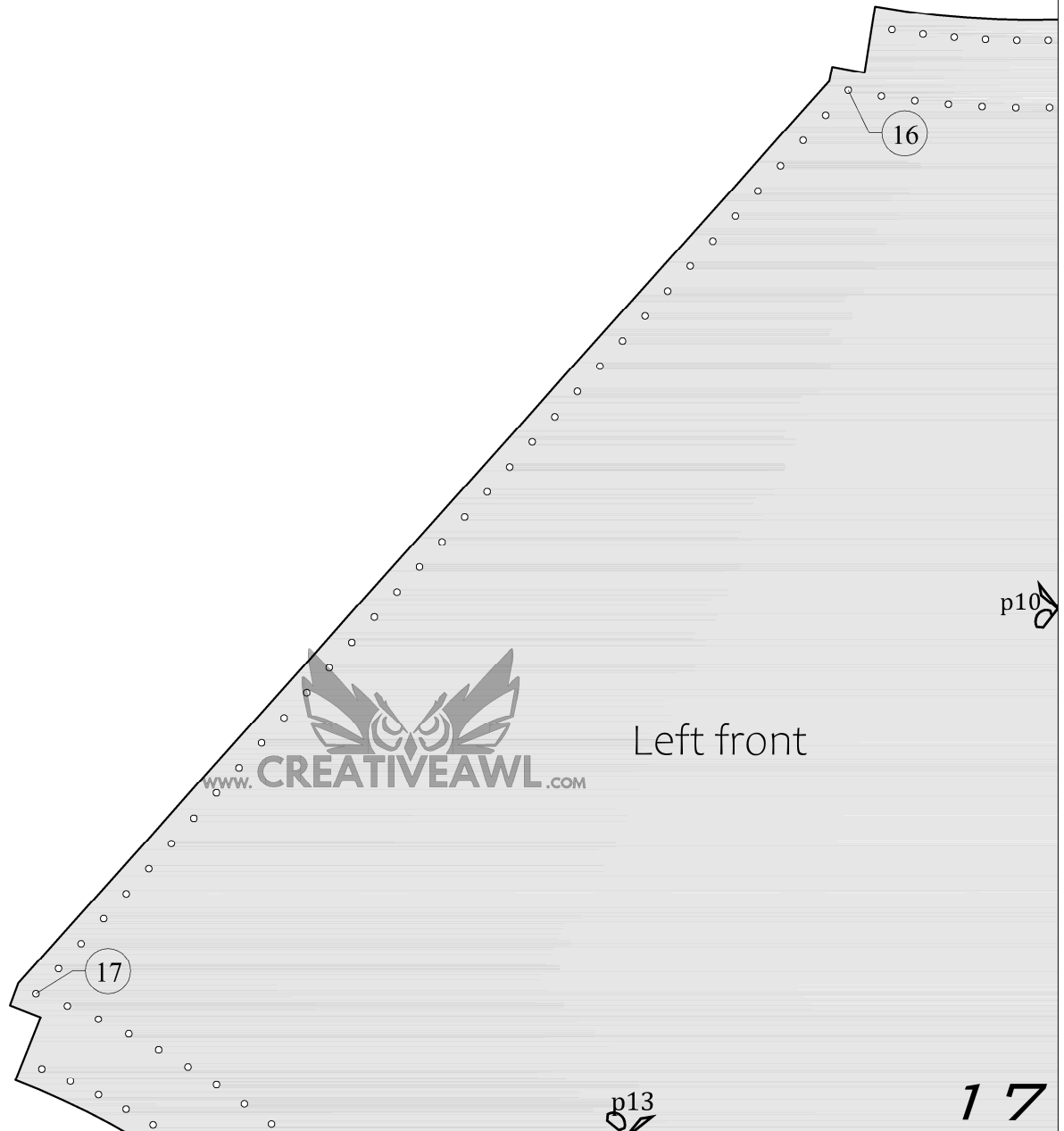

11 in
LETTER
8,5 in

A4

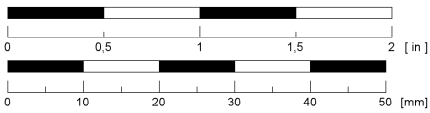

Ranger jacket - size L -

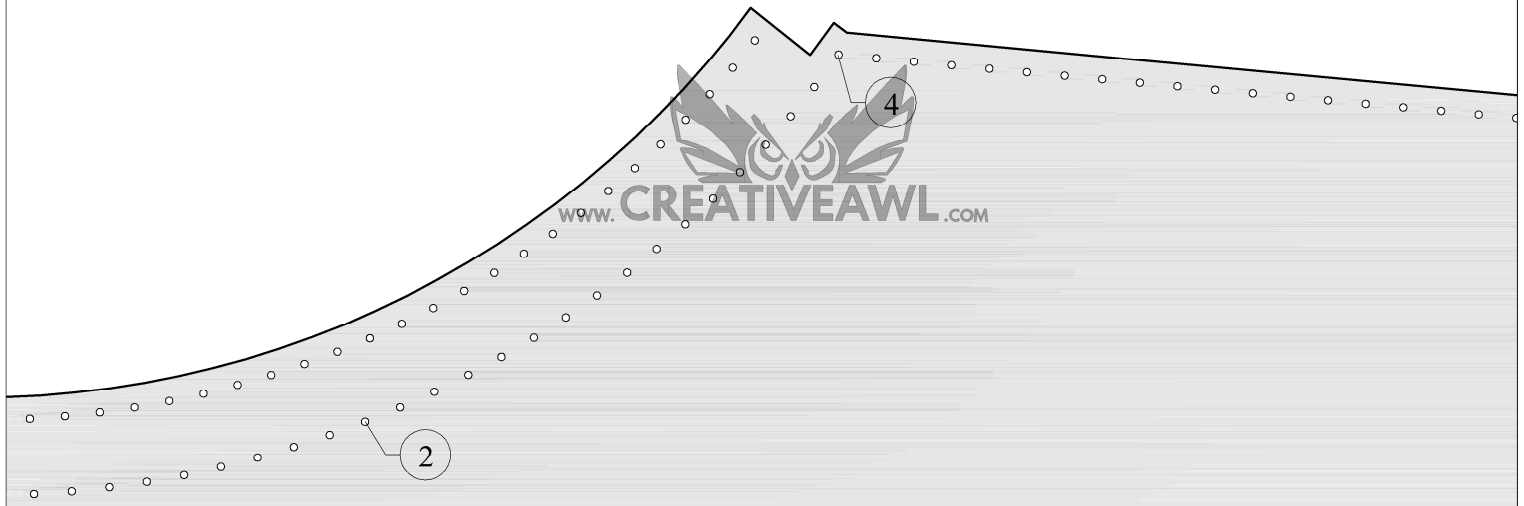

p11

Left front

p10

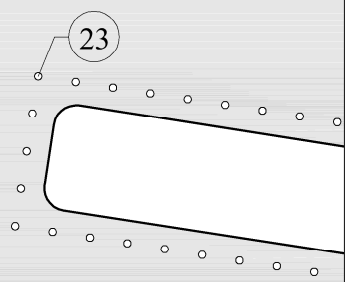

p14

11 in
LETTER
8,5 in

A4

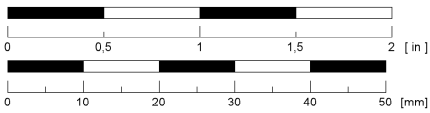

Ranger jacket - size L -

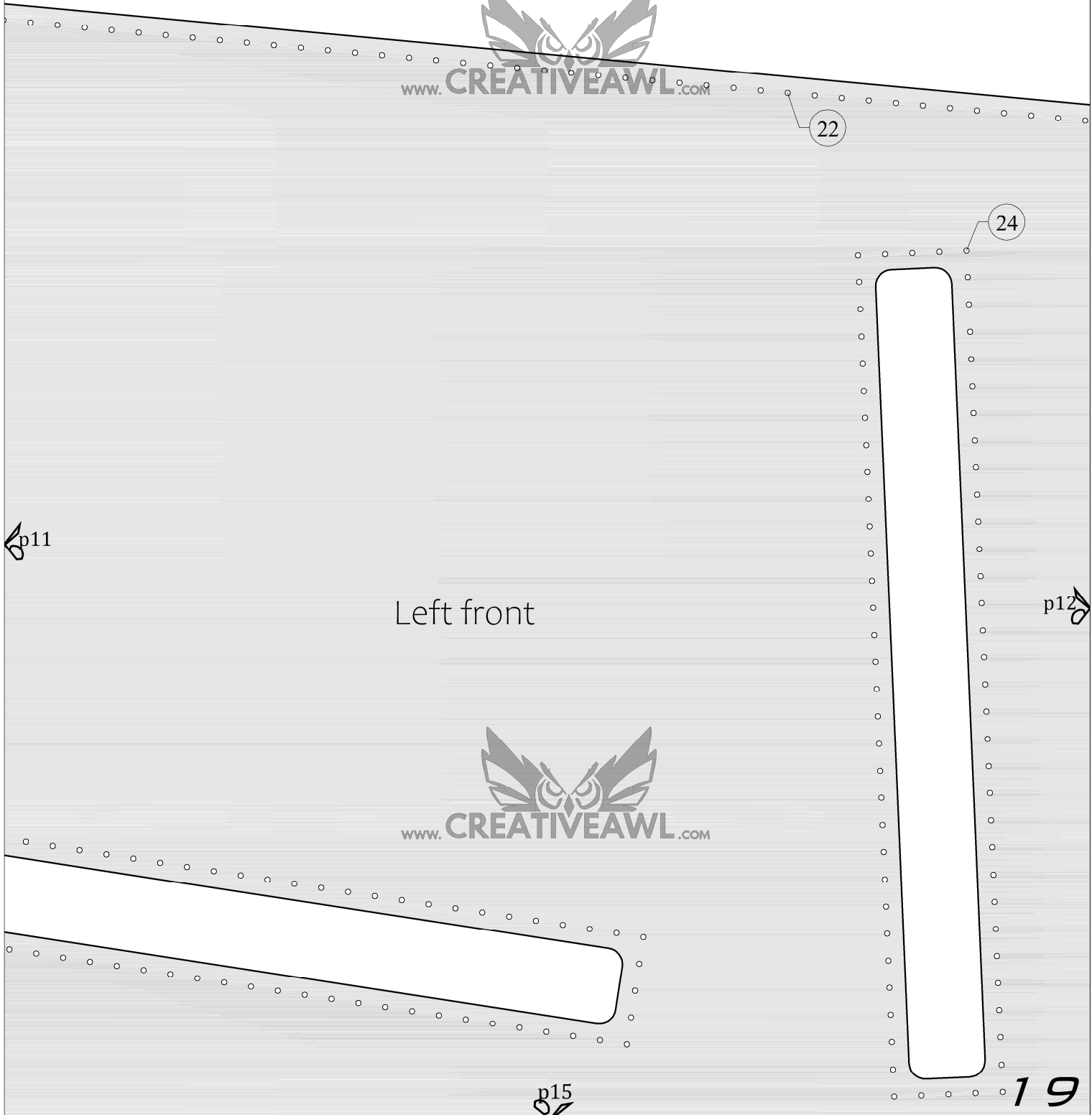

www.CREATIVEAWL.COM

22

24

p11

Left front

p12



p15

19

11 in
LETTER
8,5 in

A4

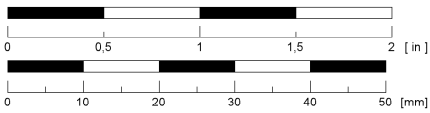

Ranger jacket - size L -

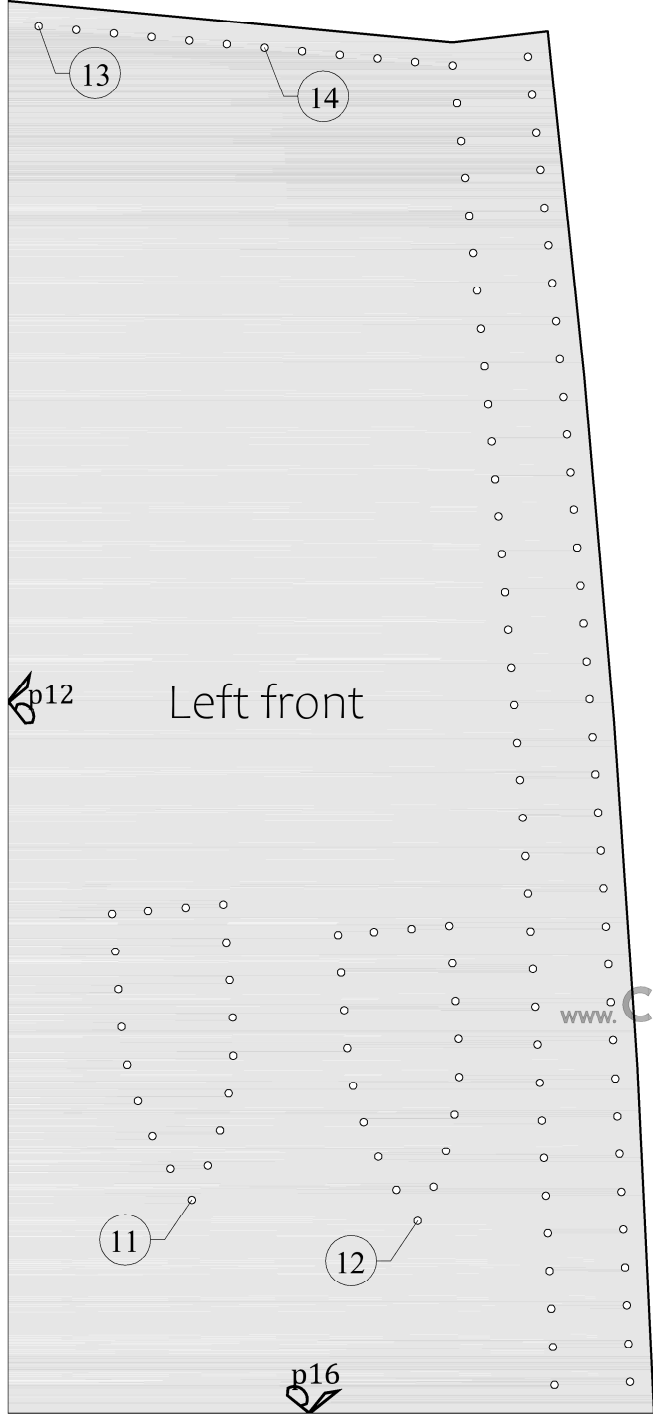

p13

18

Left front

p17

15



Left front addons

13



11 in
LETTER
8,5 in

A4

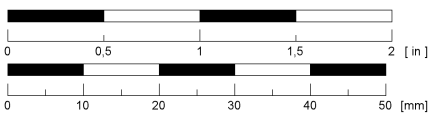

Ranger jacket
- size L -

 www.CREATIVEAWL.COM
 Left front

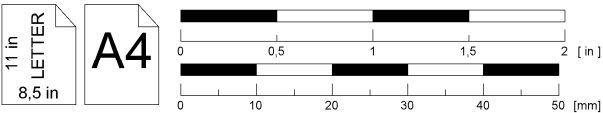
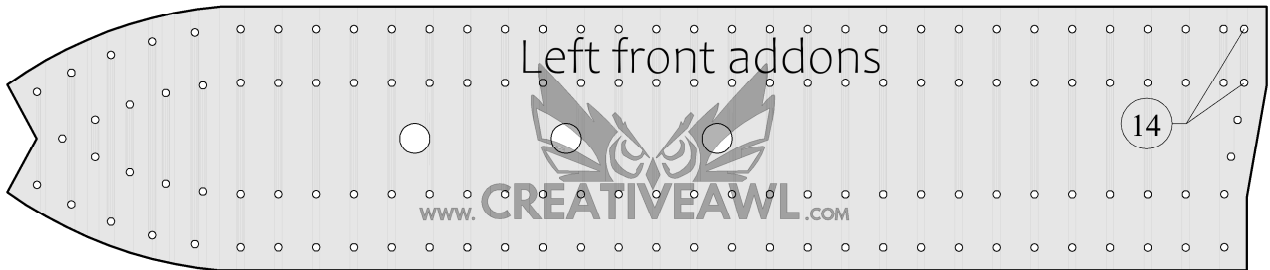

Ranger jacket
- size L -

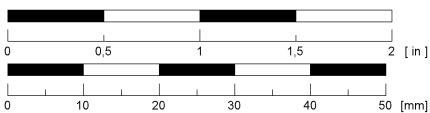
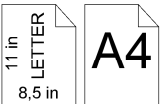
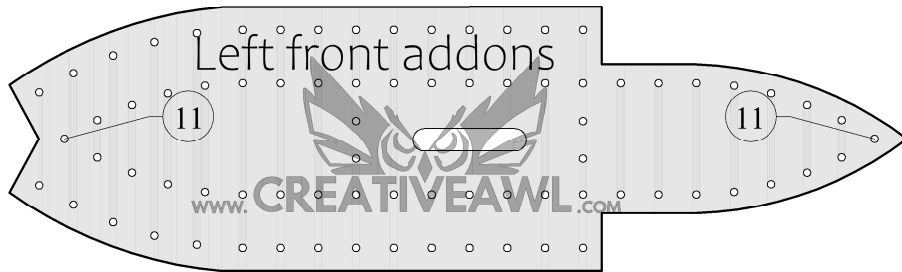
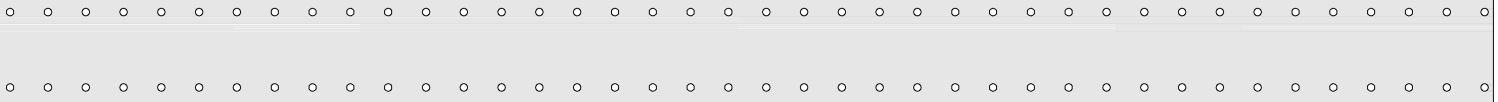

Ranger jacket
- size L -

p16

Left front

p19

10



www.CREATIVEAWL.COM

Left front addons

12

12

www.CREATIVEAWL.COM

11 in
LETTER
8,5 in
A4

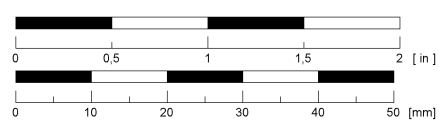

Ranger jacket
- size L -

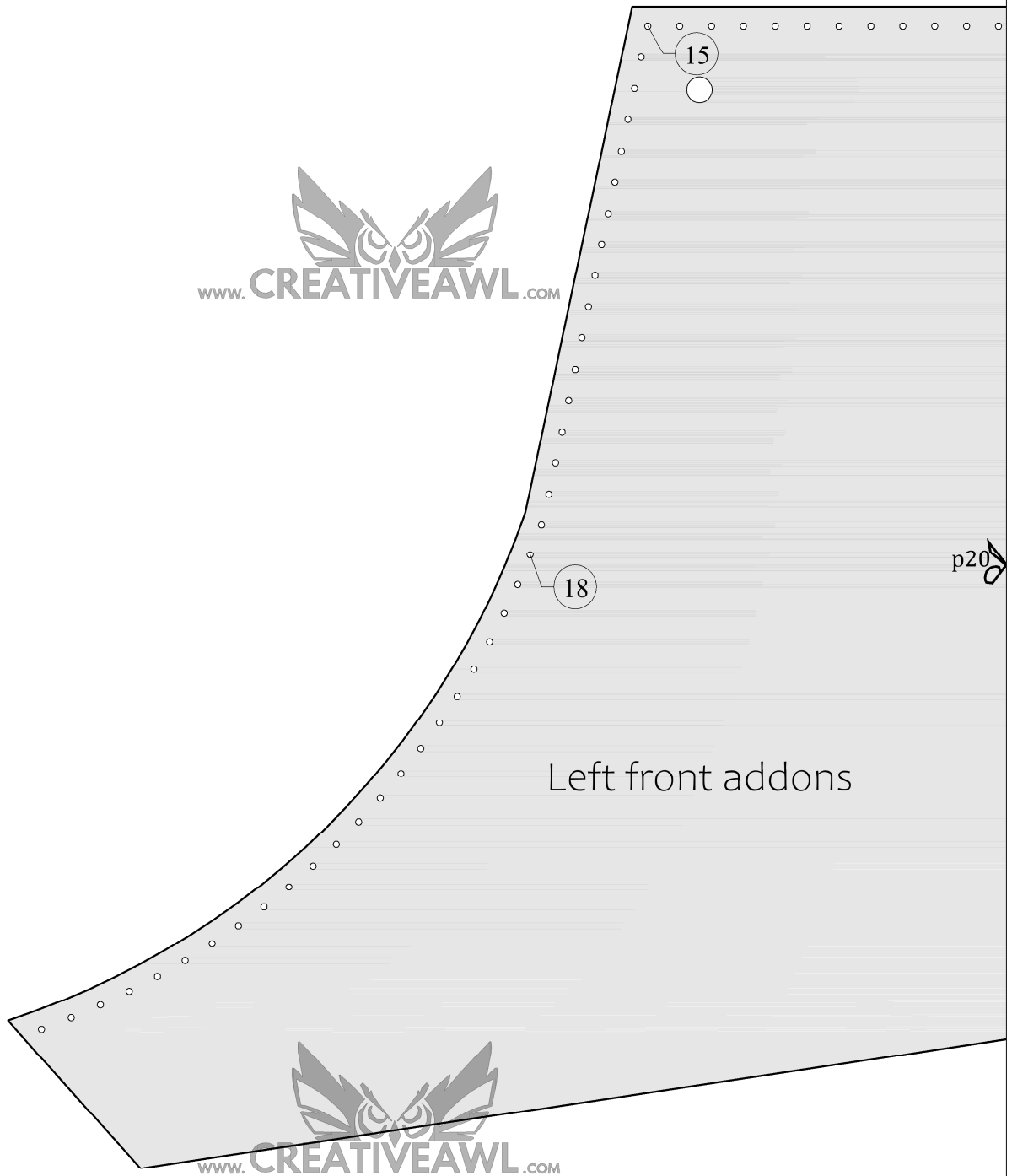

11 in
LETTER
8,5 in

A4

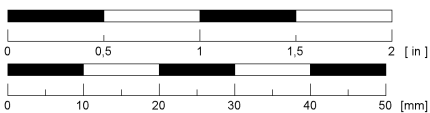

Ranger jacket
- size L -



p21

Left front addons

p20



11 in
LETTER
8,5 in

A4

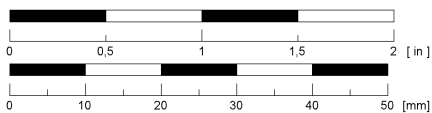

Ranger jacket
- size L -



p22

Left front addons

p21



11 in
LETTER
8,5 in

A4

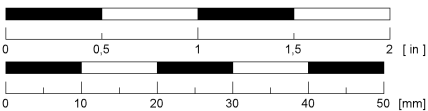

Ranger jacket
- size L -

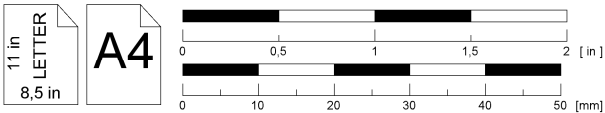
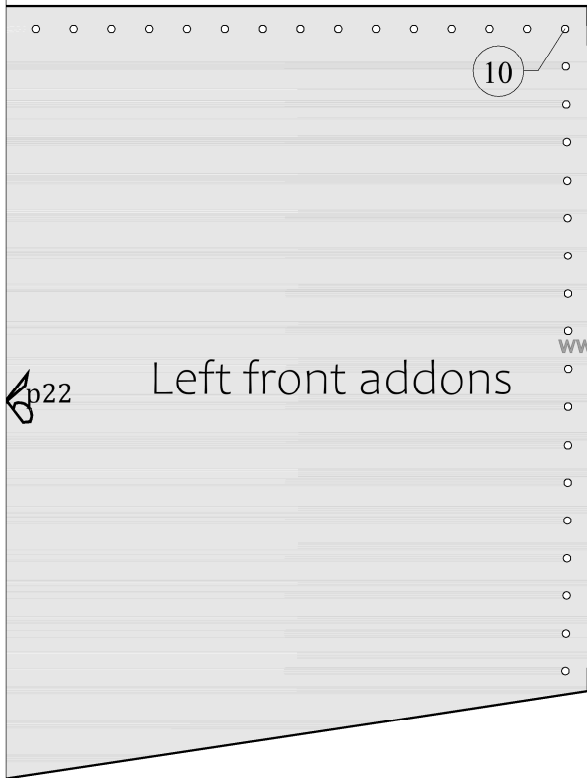

Ranger jacket
- size L -

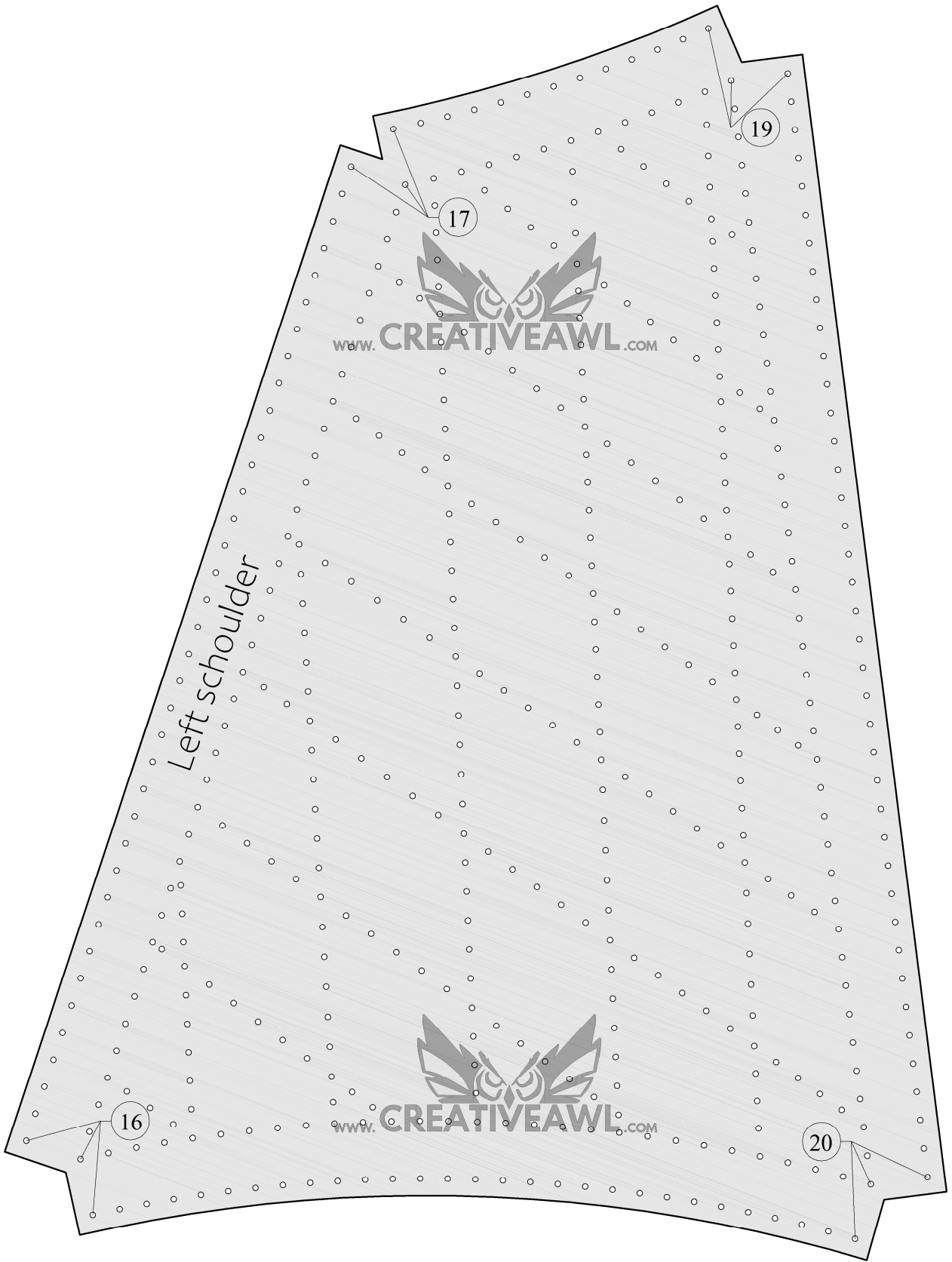

11 in
LETTER
8,5 in

A4

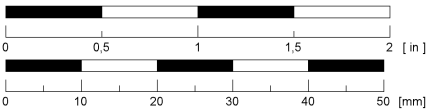

Ranger jacket
- size L -

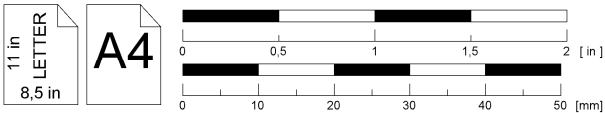
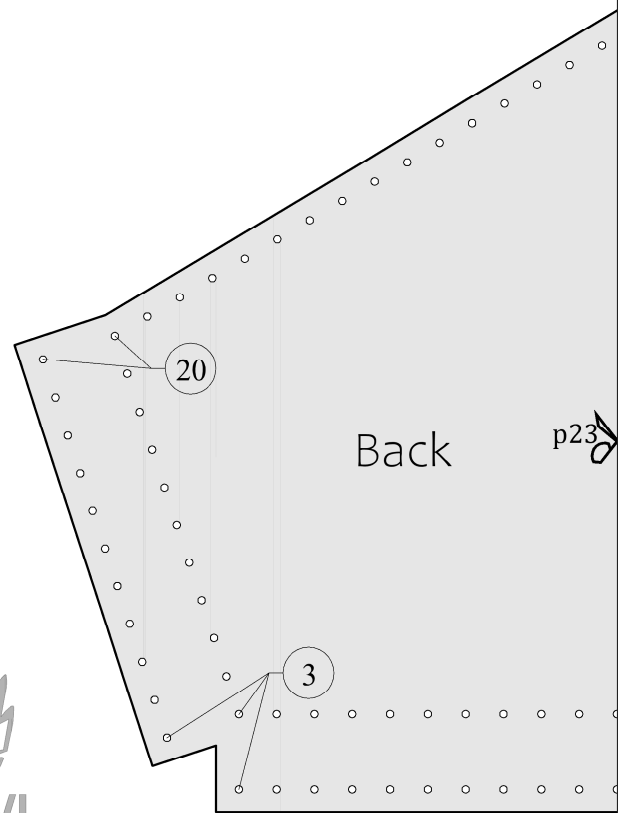

Ranger jacket
- size L -

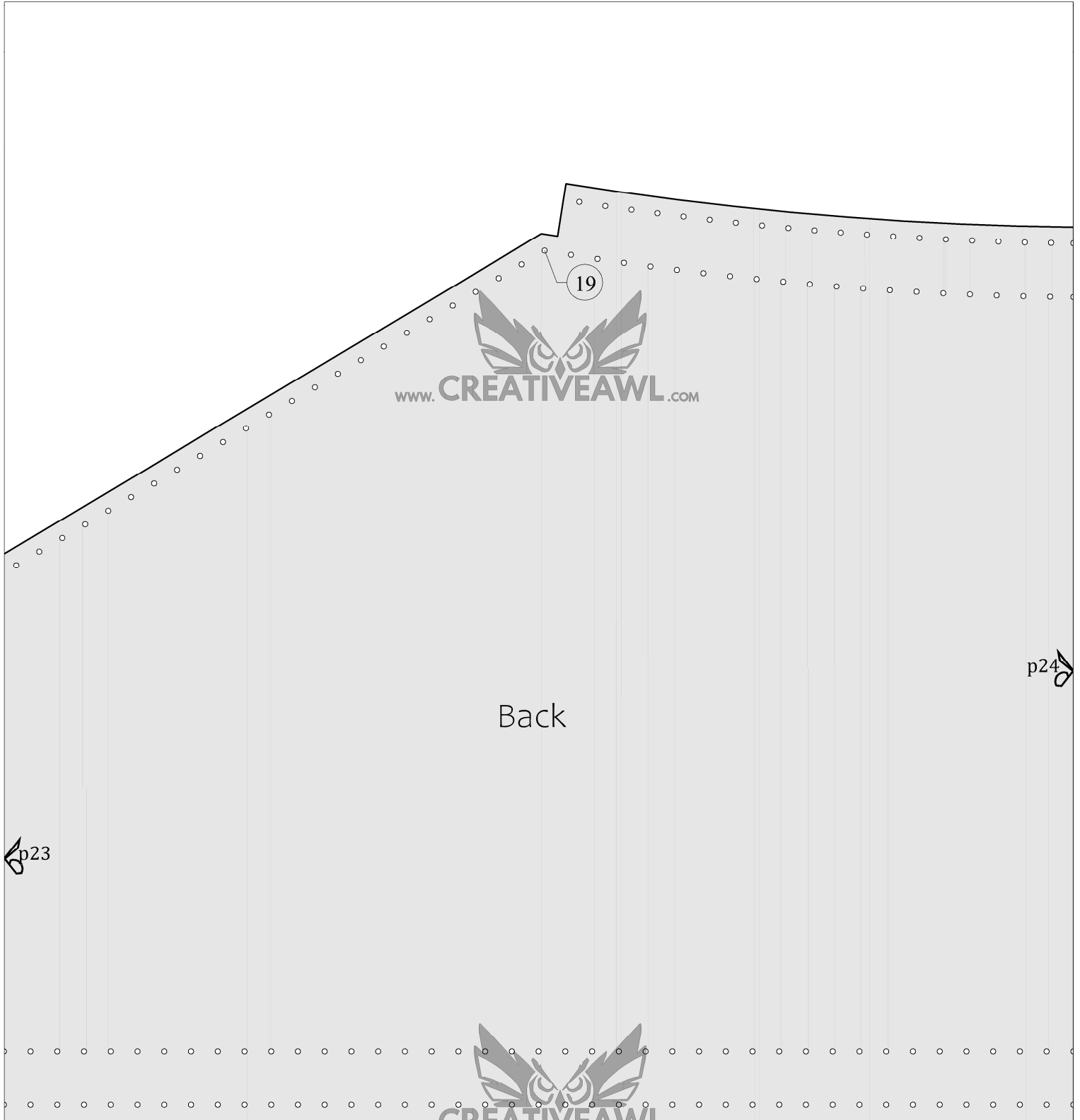

p23

p24

Back



11 in
LETTER
8,5 in

A4

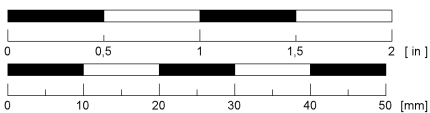

Ranger jacket
- size L -

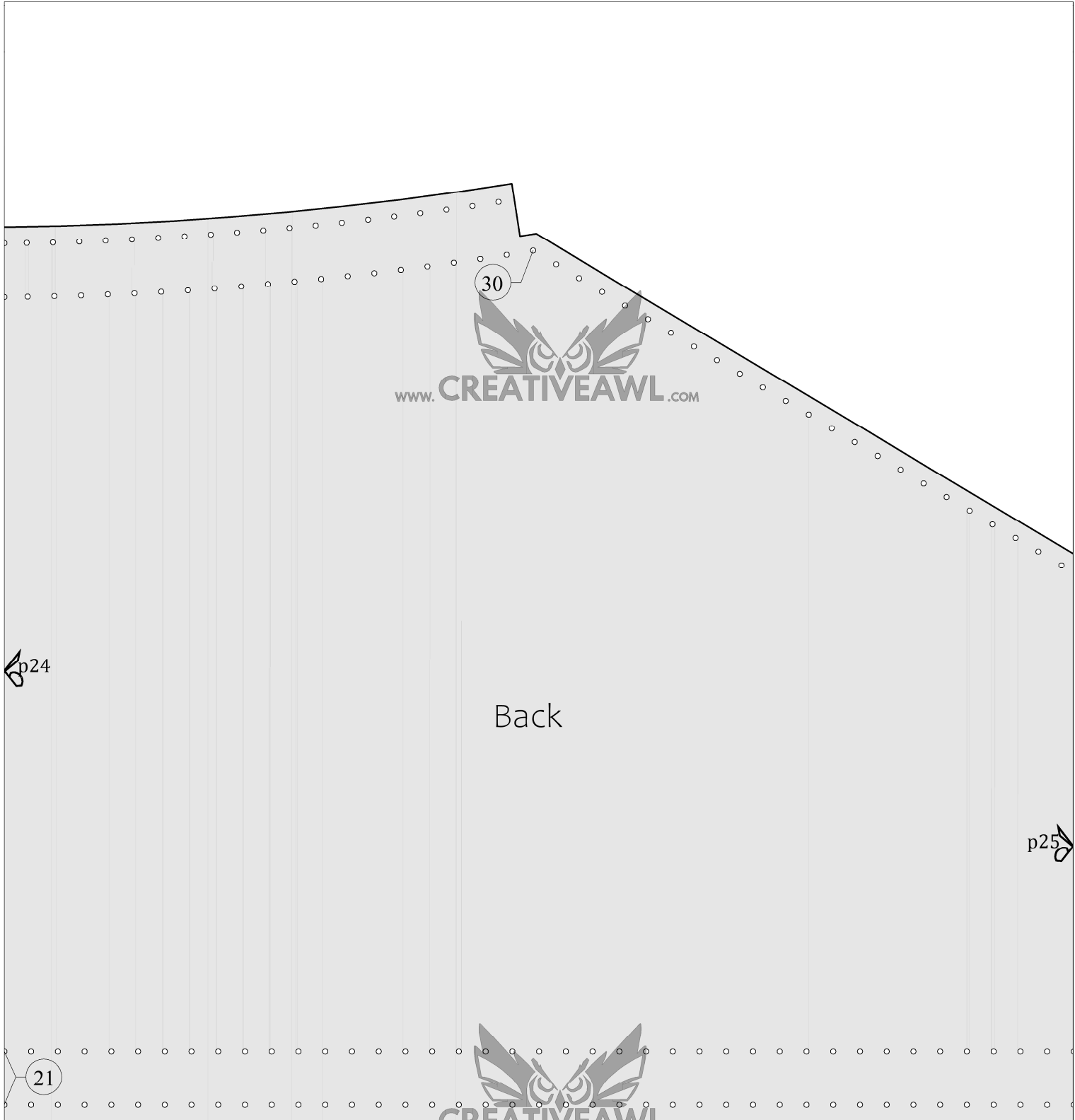

21

www.CREATIVEAWL.COM

11 in
LETTER
8,5 in

A4

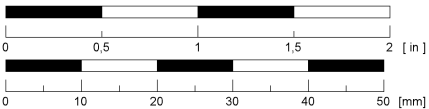

Ranger jacket
- size L -

32

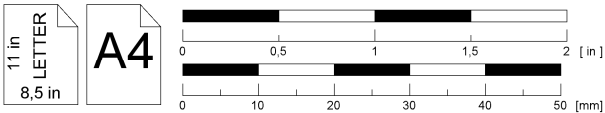
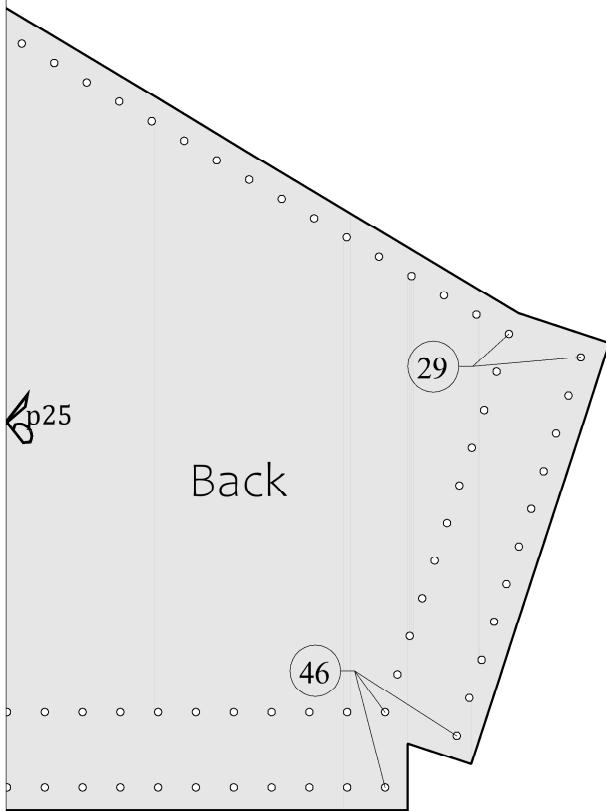

Ranger jacket
- size L -

11 in
LETTER
8,5 in

A4

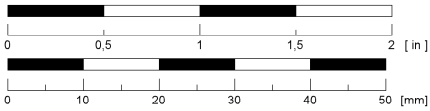

Ranger jacket - size L -

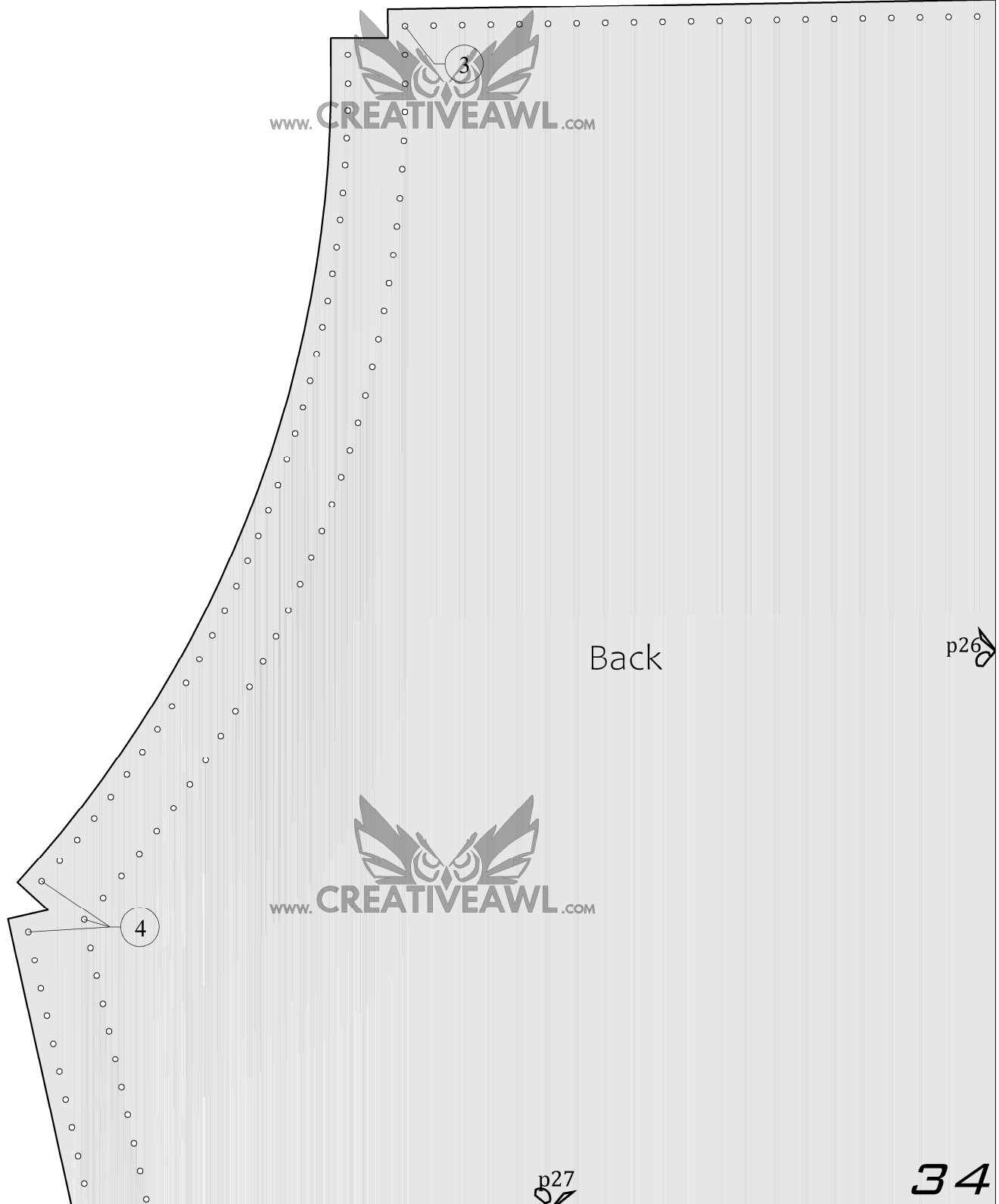

11 in
LETTER
8,5 in

A4

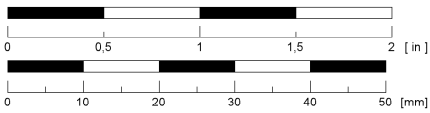

Ranger jacket - size L -

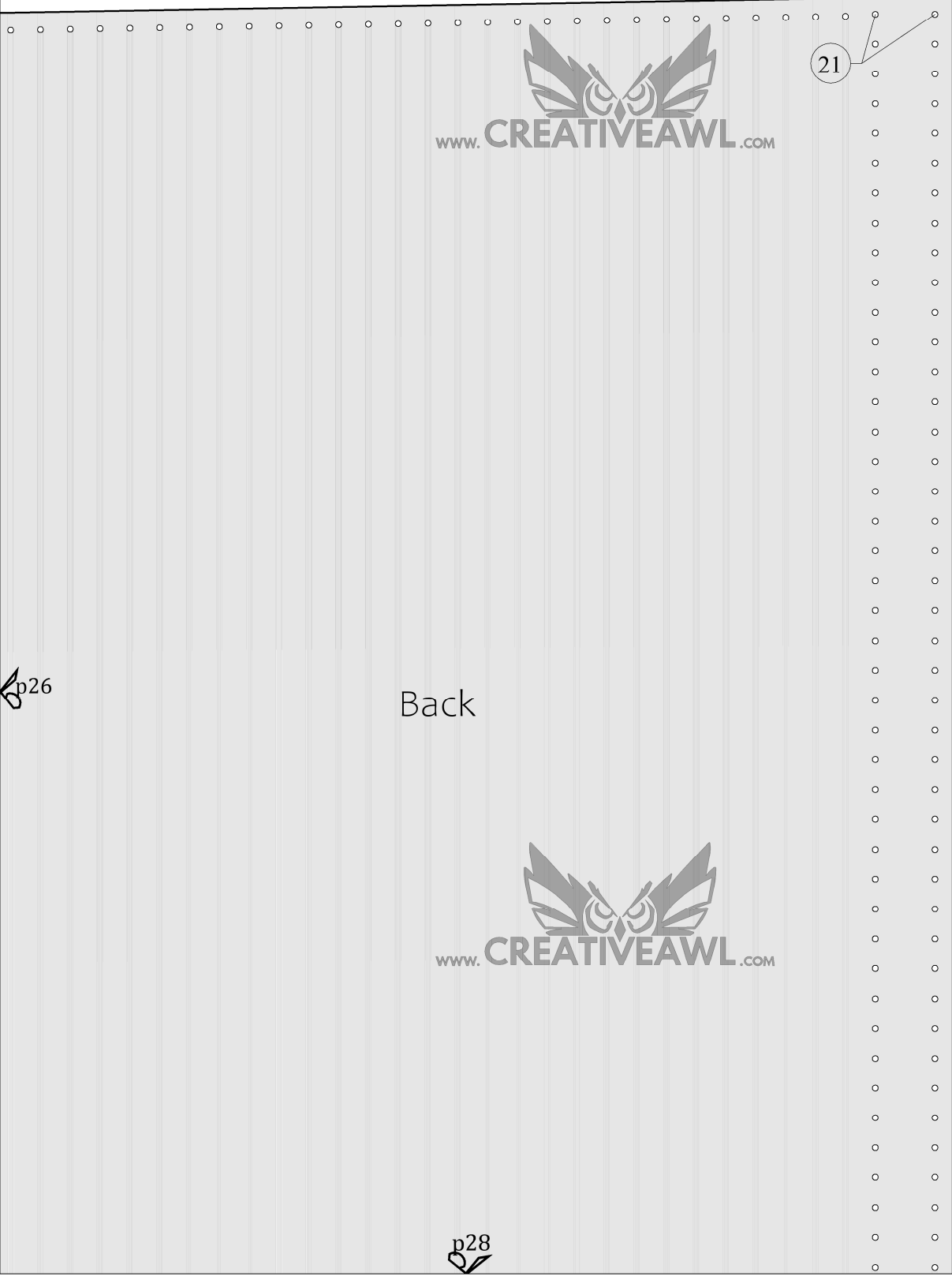

21

p26

Back



p28

p27



www.CREATIVEAWL.COM

Back

p29

22



www.CREATIVEAWL.COM

11 in
LETTER
8,5 in

A4

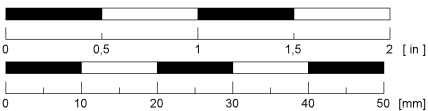

Ranger jacket
- size L -

36

p28



Back

p29



11 in
LETTER
8,5 in

A4

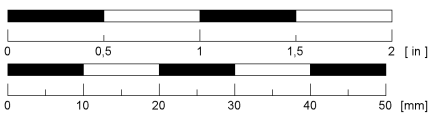

Ranger jacket
- size L -

37

11 in
LETTER
8,5 in

A4

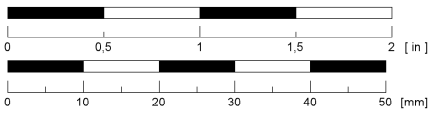

Ranger jacket - size L -



11 in
LETTER
8,5 in

A4

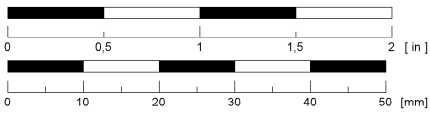

Ranger jacket - size L -

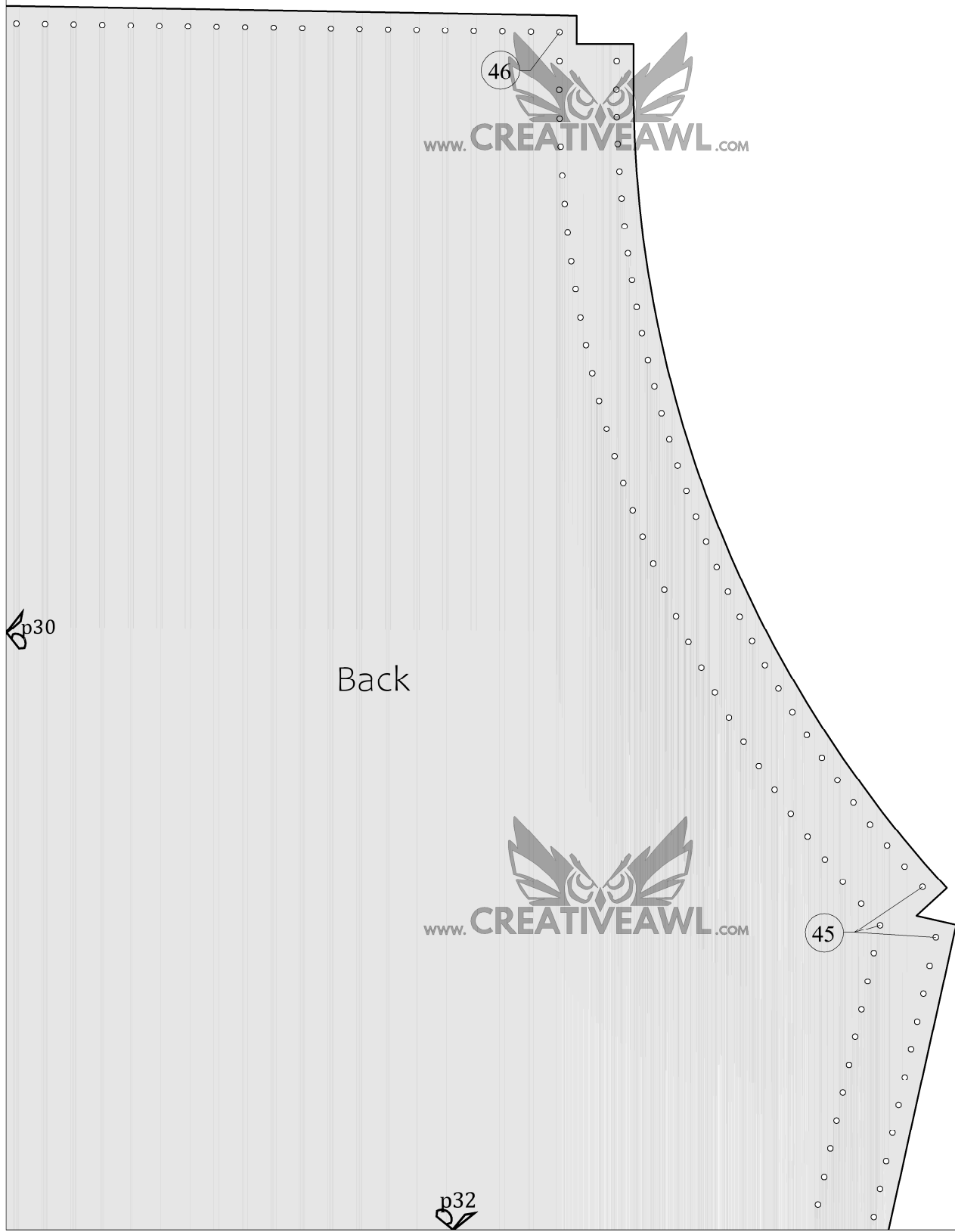

46

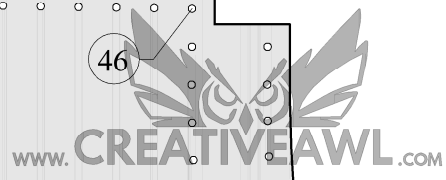

p30

Back



45

p32

p31



p33

Back

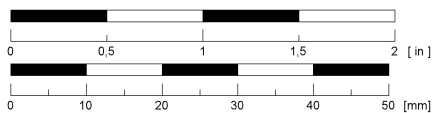
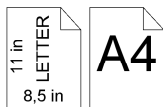

Ranger jacket
- size L -

40

p32



p33

Back

27



11 in
LETTER
8,5 in

A4

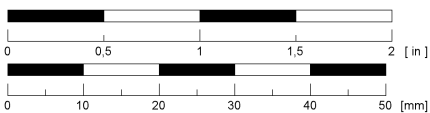

Ranger jacket
- size L -

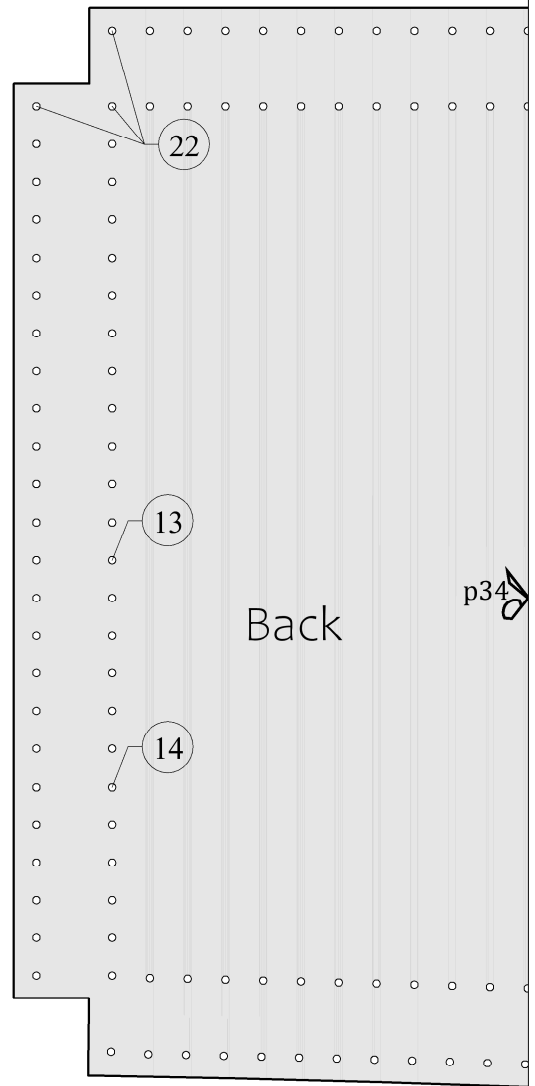

p34

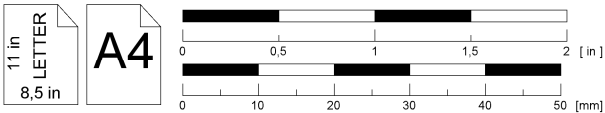

Ranger jacket
- size L -



www.CREATIVEAWL.COM

p34

Back

p35

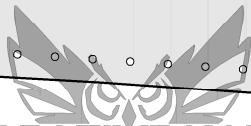

www.CREATIVEAWL.COM

11 in
LETTER
8,5 in

A4

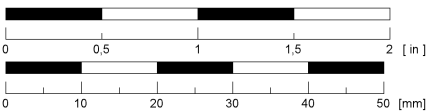

Ranger jacket
- size L -

43



www.CREATIVEAWL.COM

p35

Back

p36

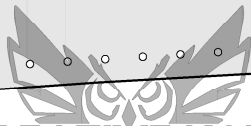

www.CREATIVEAWL.COM

11 in
LETTER
8,5 in

A4

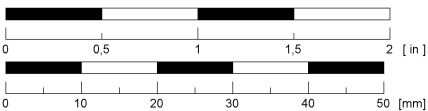

Ranger jacket
- size L -

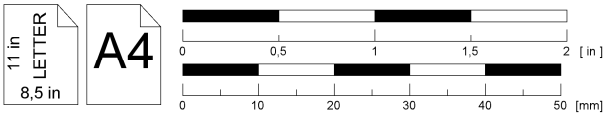
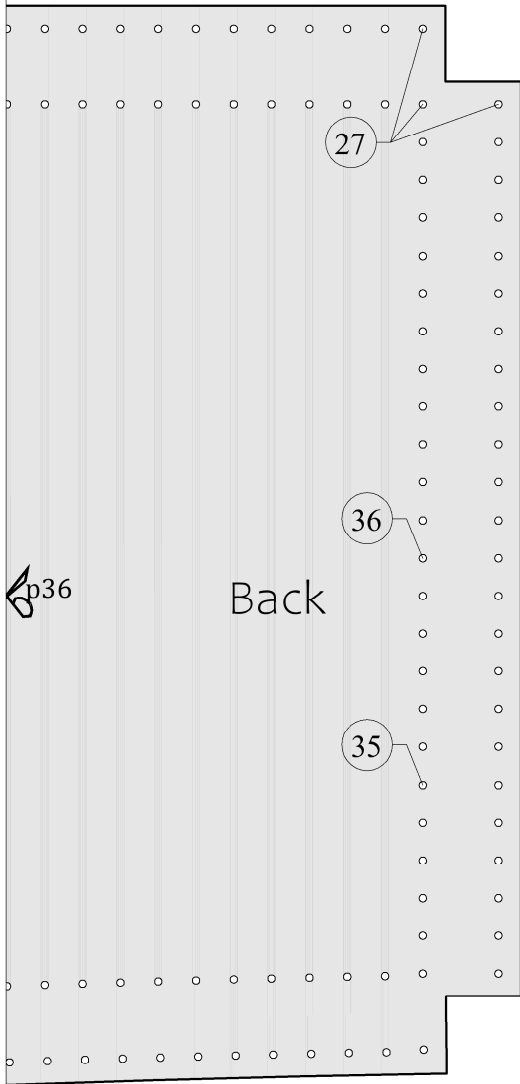

Ranger jacket
- size L -

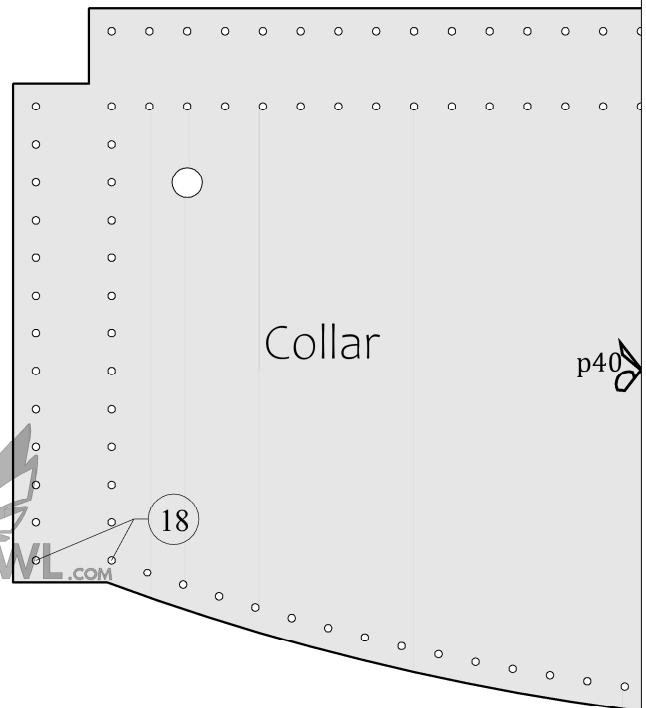
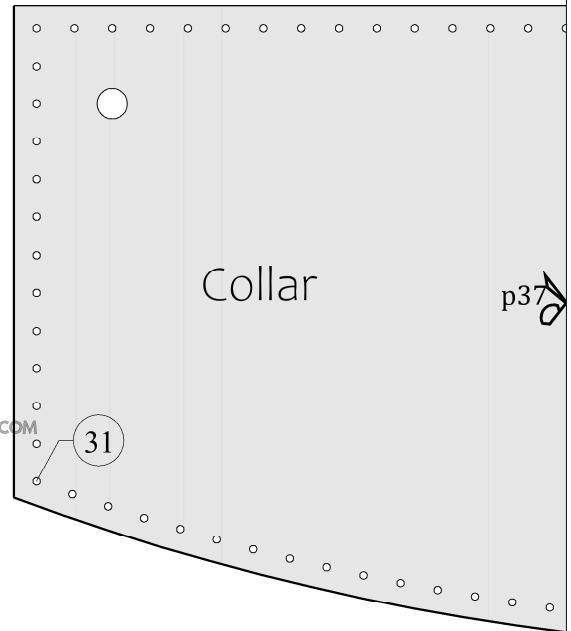

11 in
LETTER
8,5 in

A4

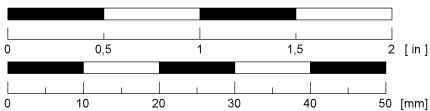

Ranger jacket
- size L -

46

p37

p38

Collar



www.CREATIVEAWL.COM

32

30

p40

p41

Collar



www.CREATIVEAWL.COM

17

19

11 in
LETTER
8,5 in

A4

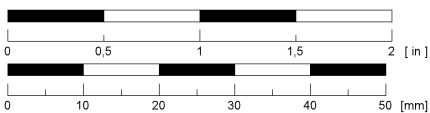

Ranger jacket

- size L -

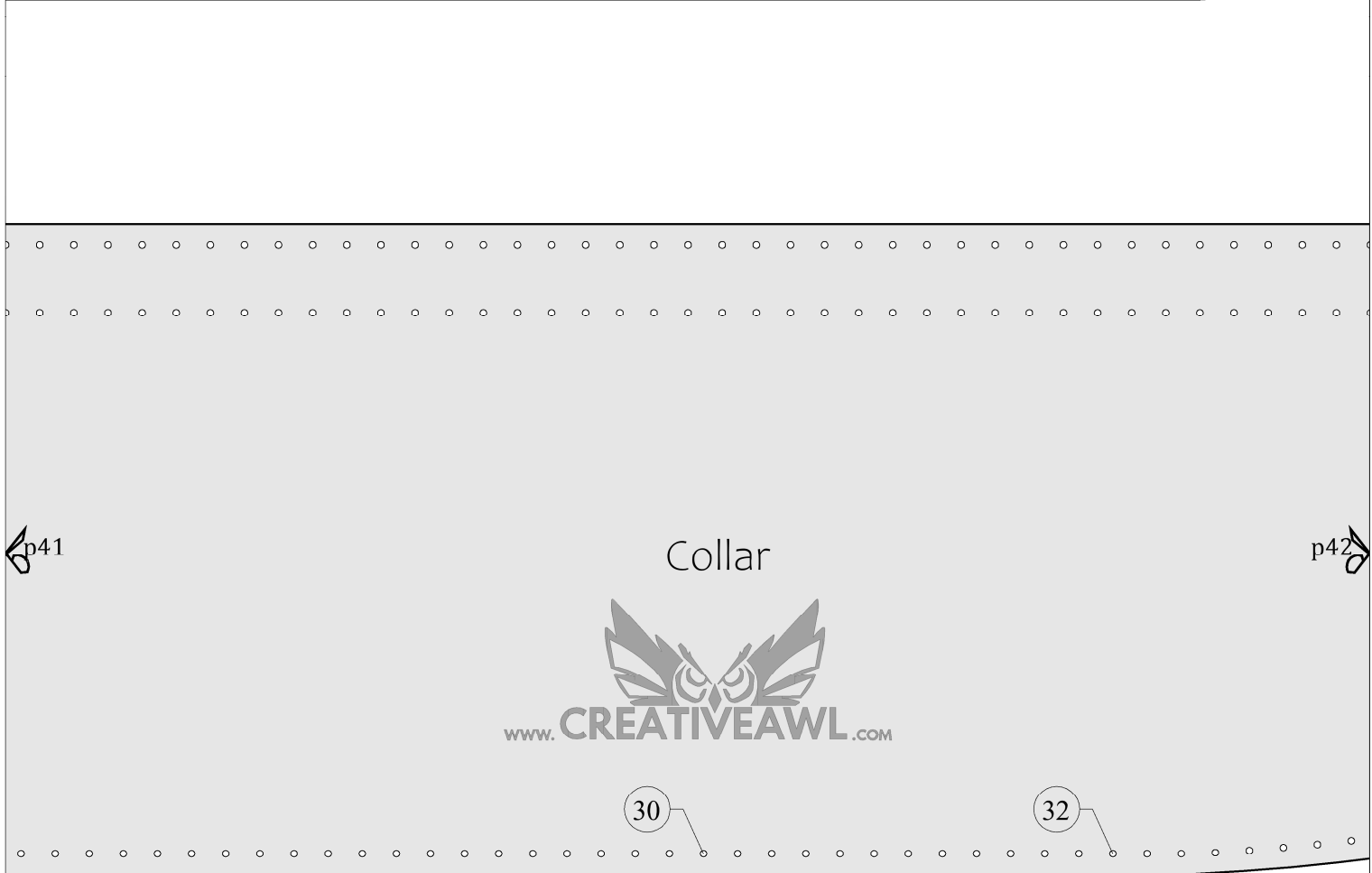

11 in
LETTER
8,5 in

A4

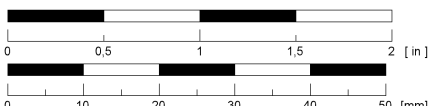

Ranger jacket
- size L -

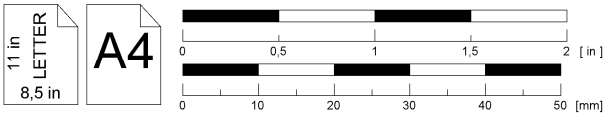
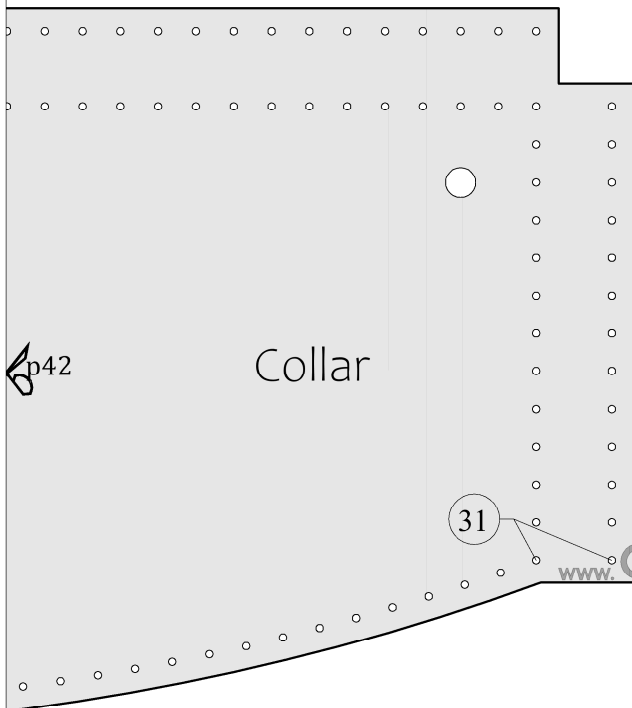
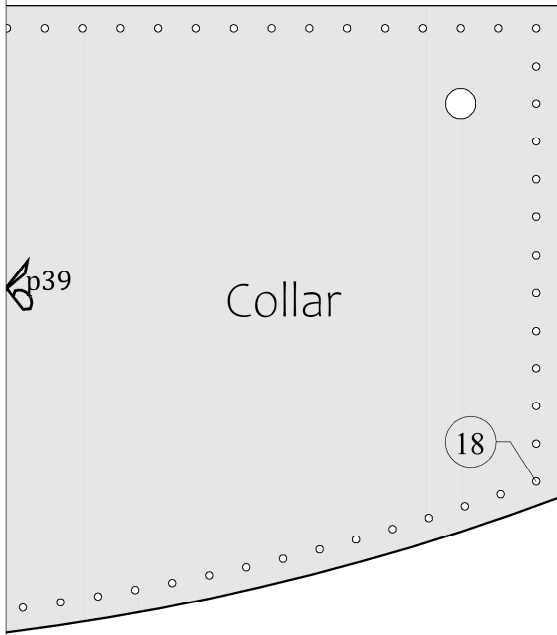

Ranger jacket
- size L -

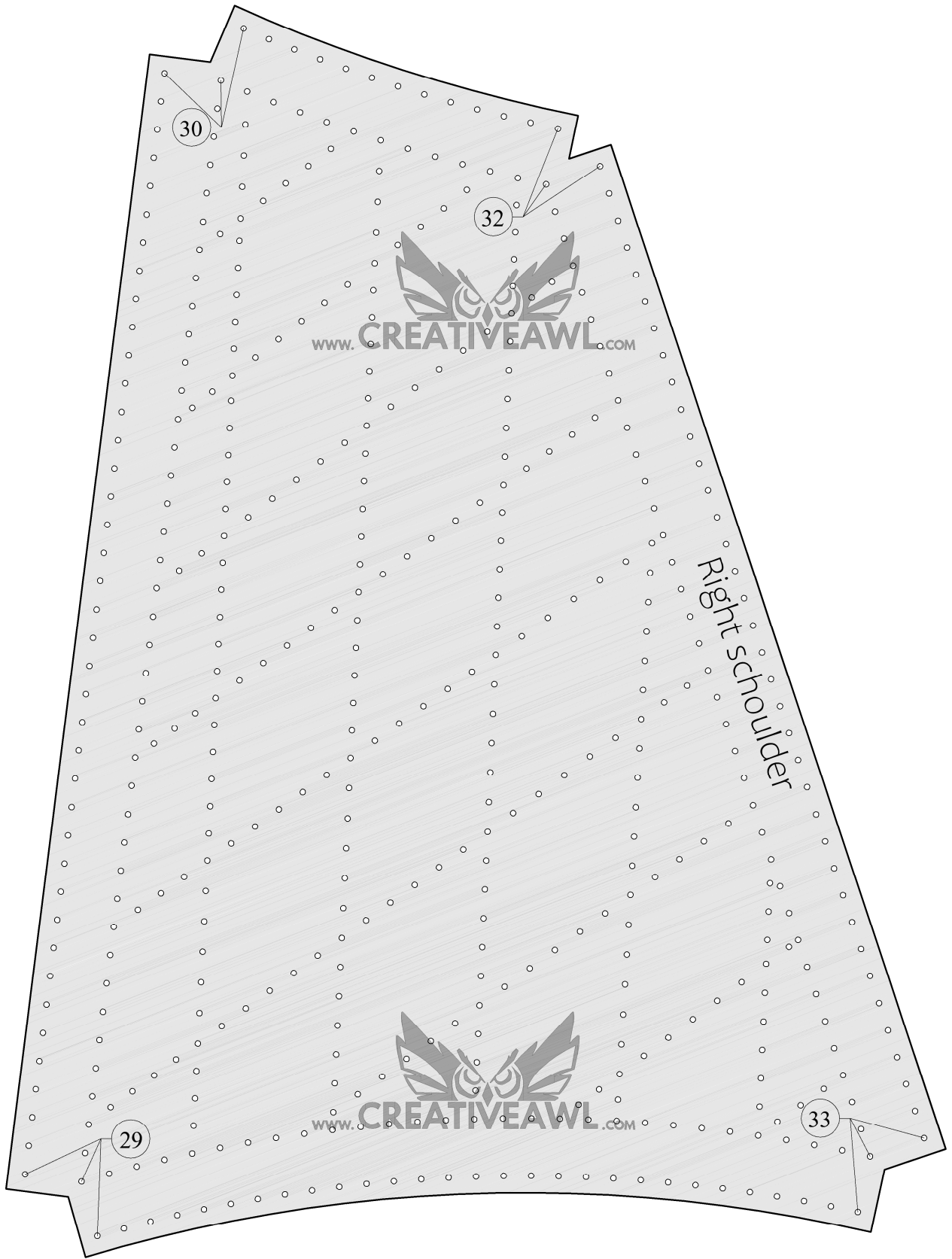

11 in
LETTER
8,5 in

A4

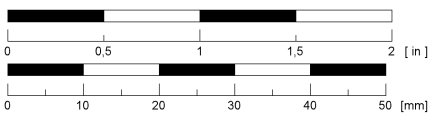

Ranger jacket
- size L -

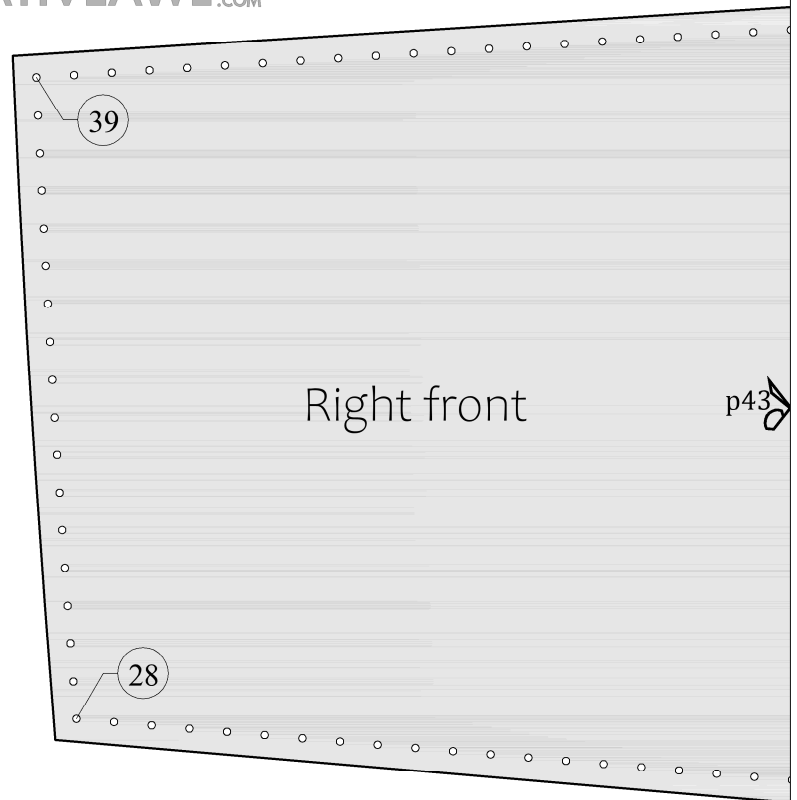



www.CREATIVEAWL.COM

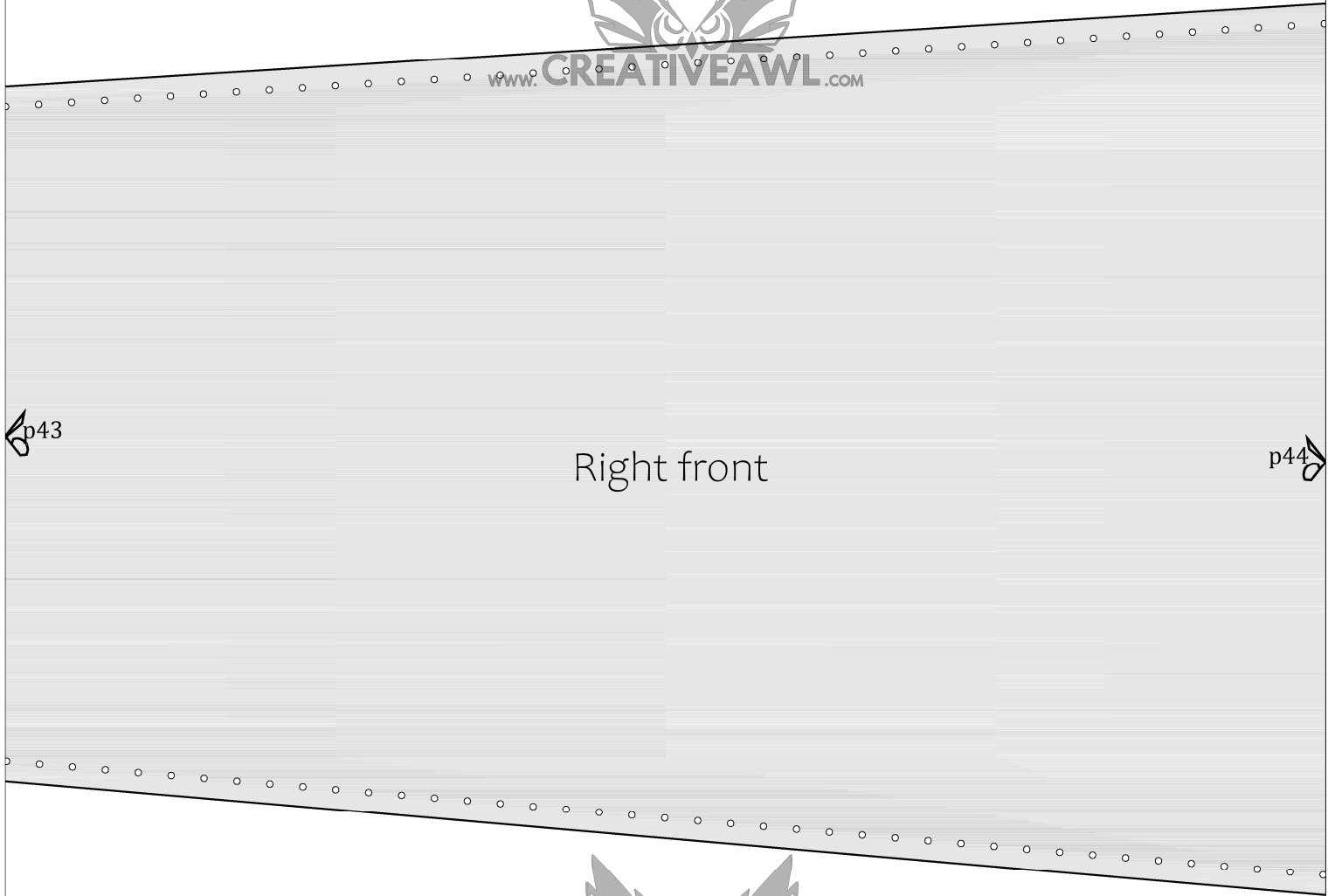

www.CREATIVEAWL.COM

11 in
LETTER
8,5 in

A4

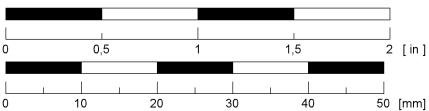

Ranger jacket
- size L -

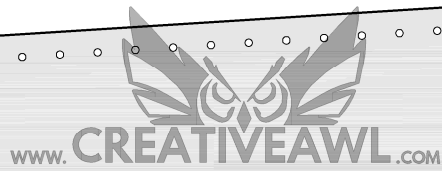

p44

Right front

p45

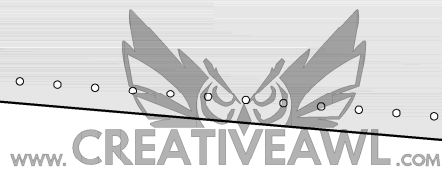

11 in
LETTER
8,5 in

A4

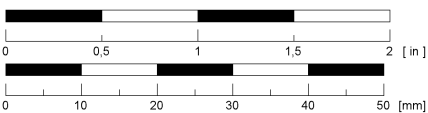

Ranger jacket
- size L -

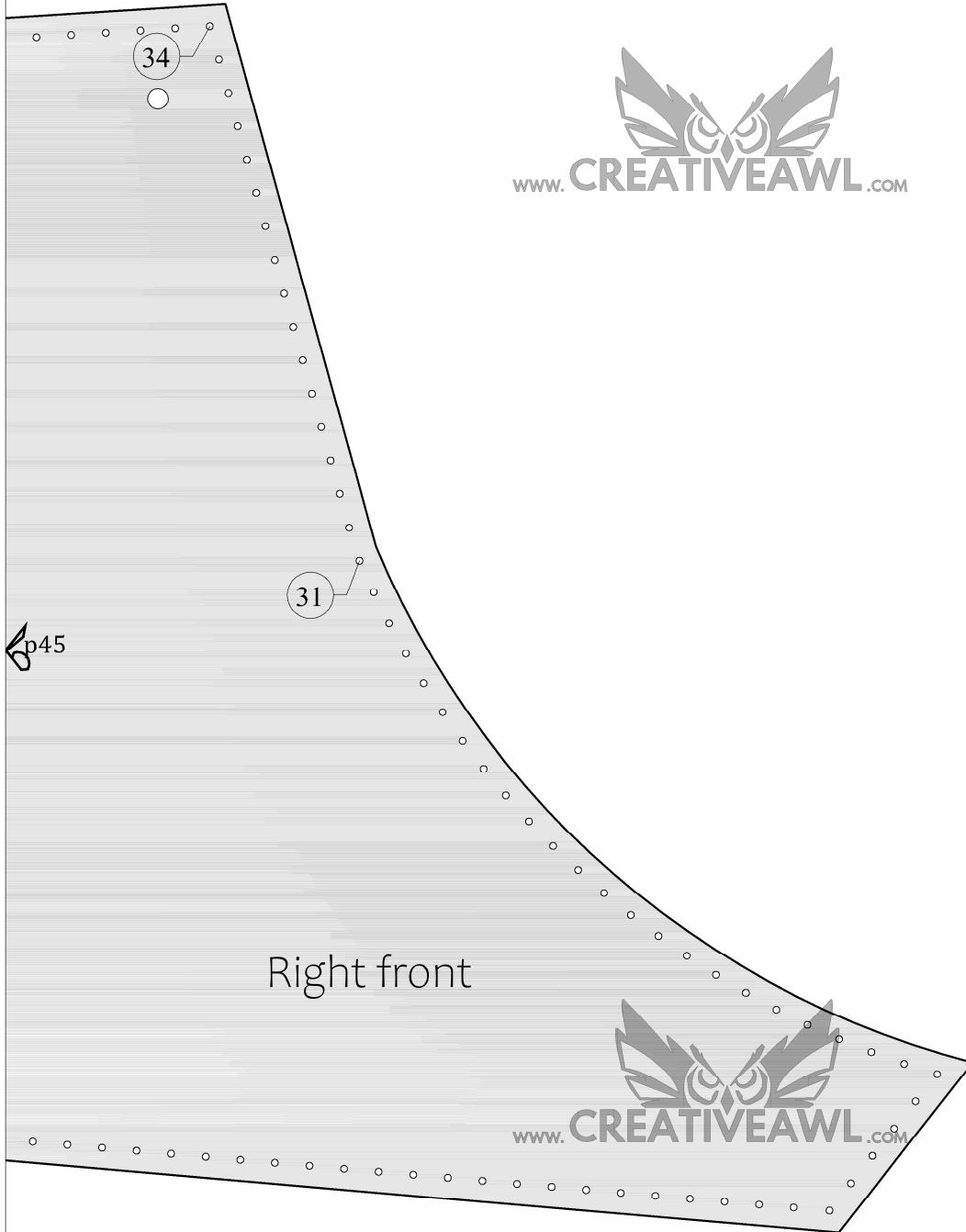

Right front

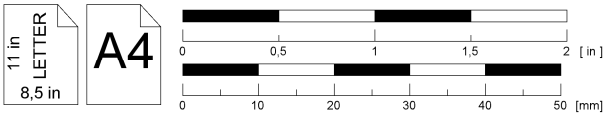

Ranger jacket
- size L -

11 in
LETTER
8,5 in

A4

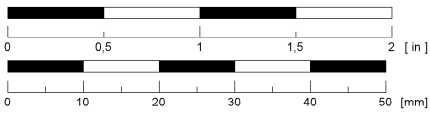

Ranger jacket - size L -



www.CREATIVEAWL.COM

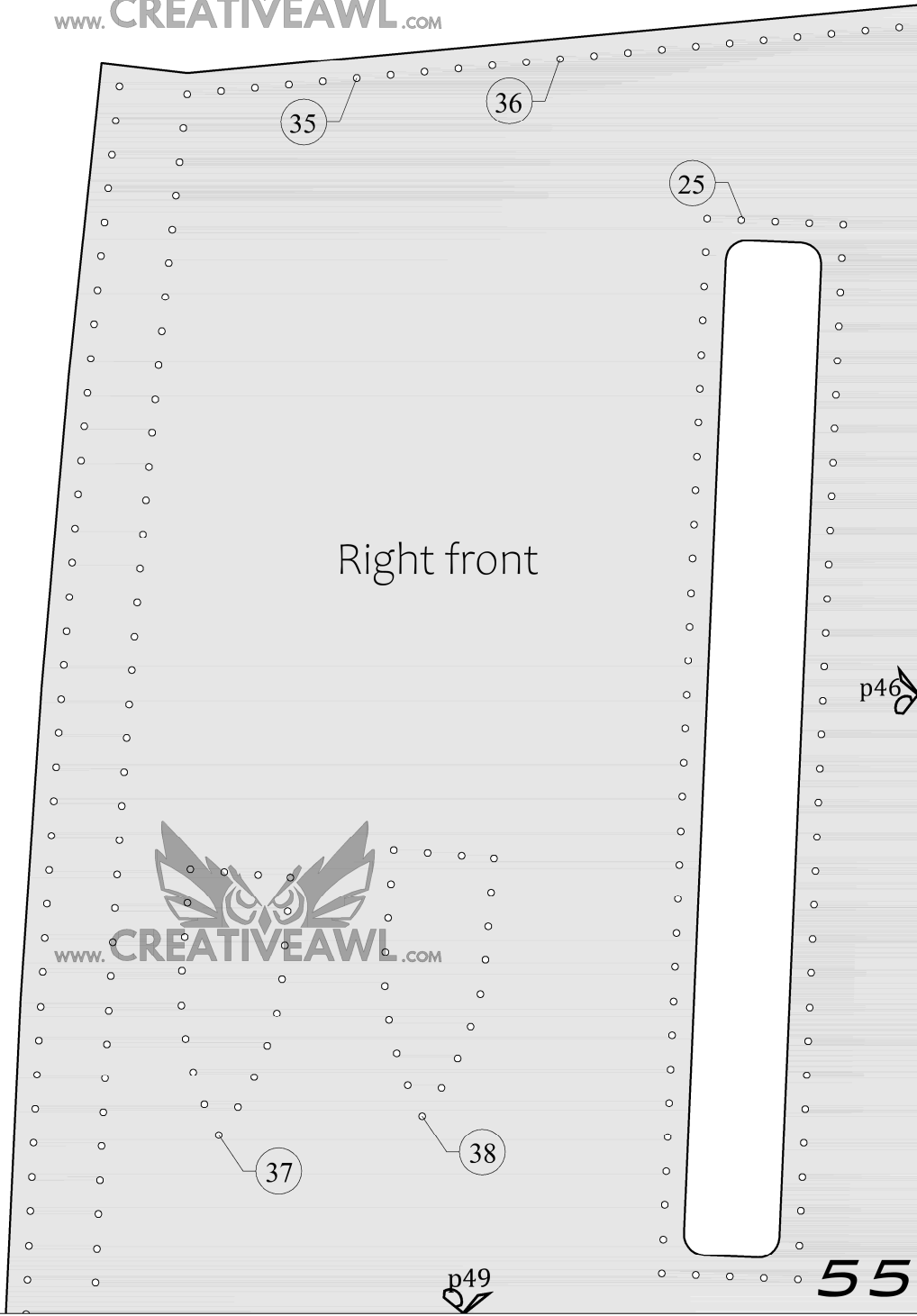

Right front



www.CREATIVEAWL.COM

11 in
LETTER
8,5 in

A4

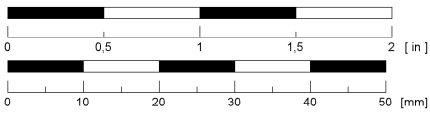

Ranger jacket - size L -

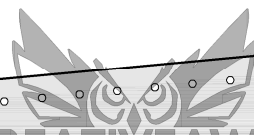
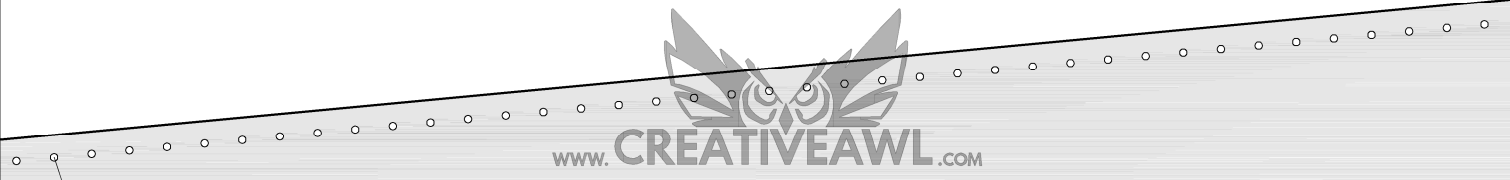

www.CREATIVEAWL.COM

Right front

p46

p47

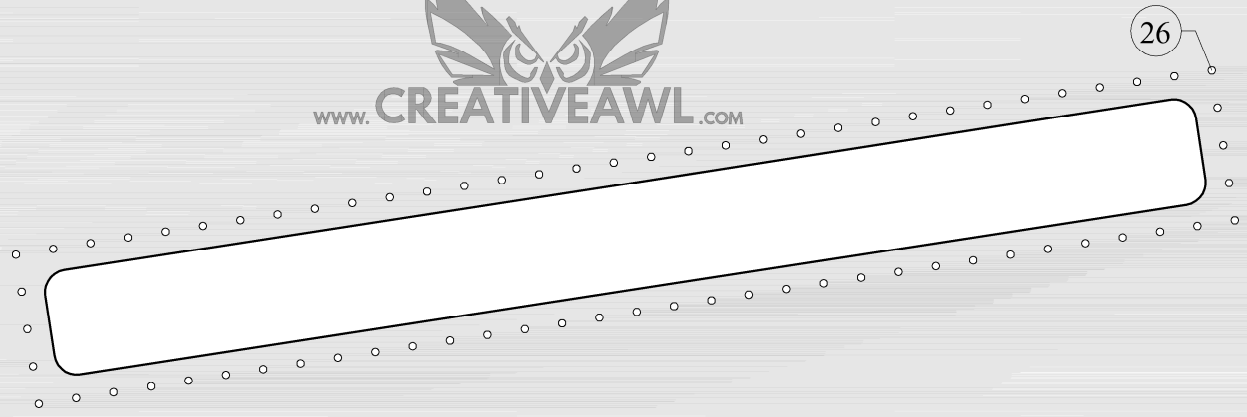

www.CREATIVEAWL.COM

p50

11 in
LETTER
8,5 in

A4

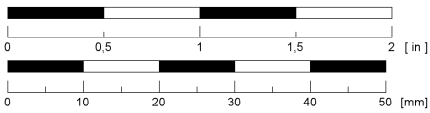

Ranger jacket - size L -

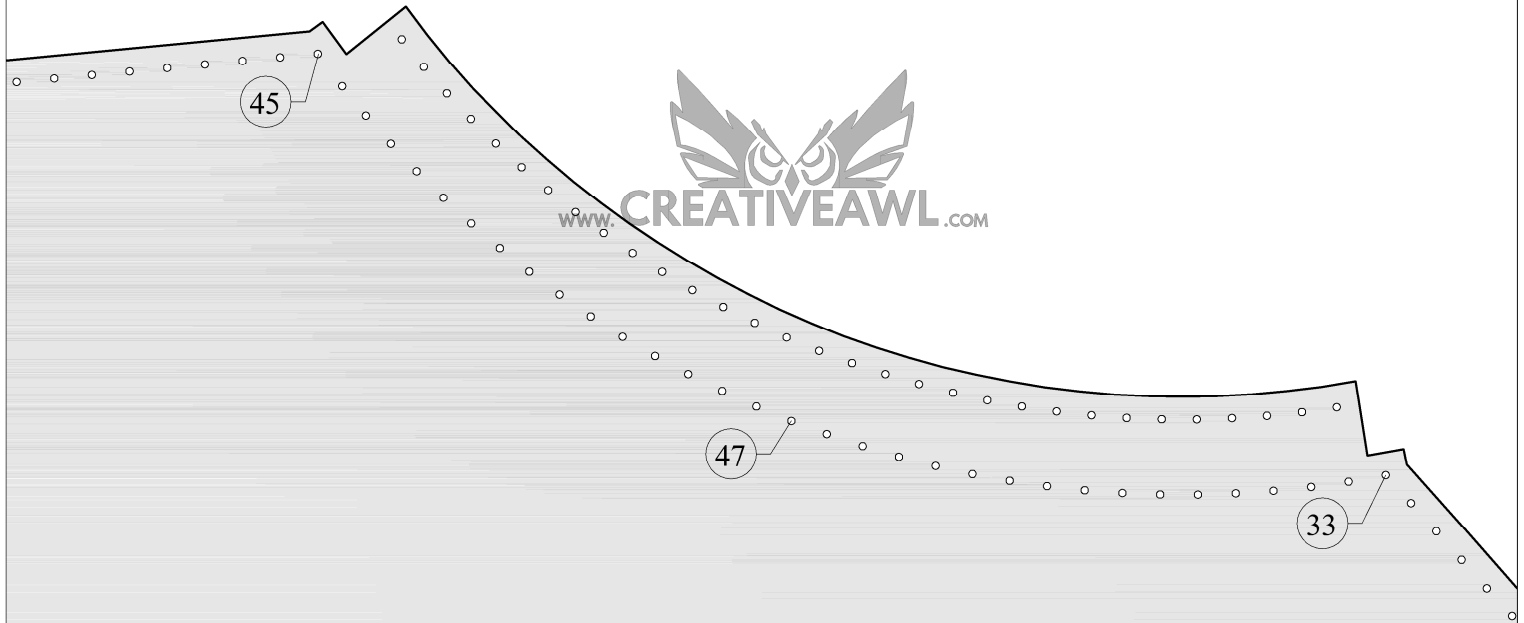

p47

Right front



p48

p51

11 in
LETTER
8,5 in

A4

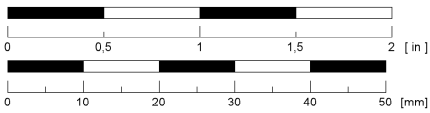

Ranger jacket - size L -

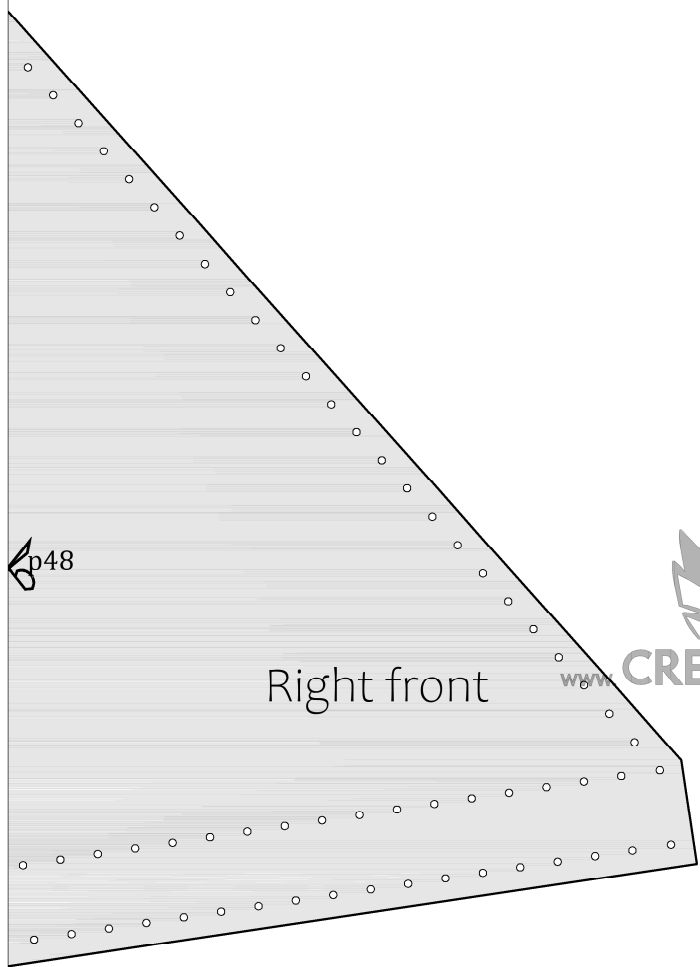

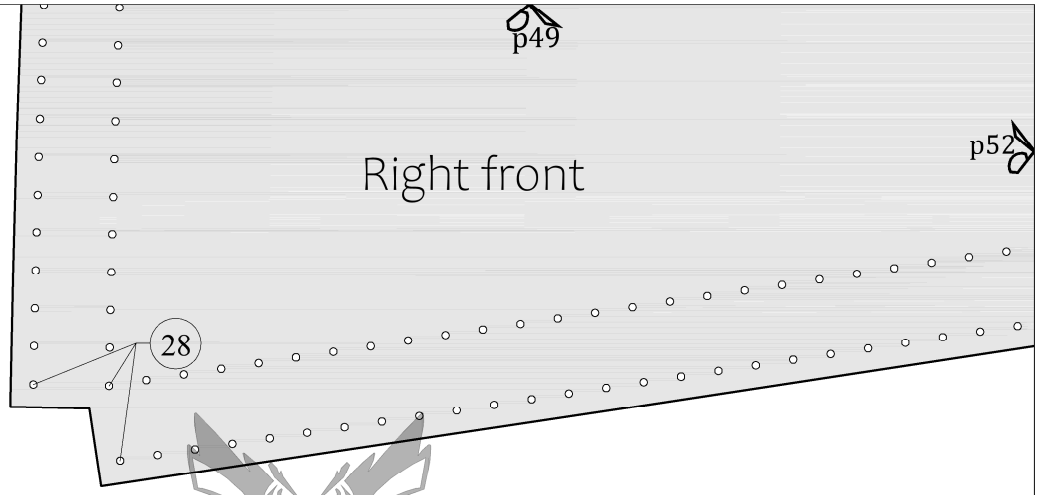

Right front

p49

p52

28

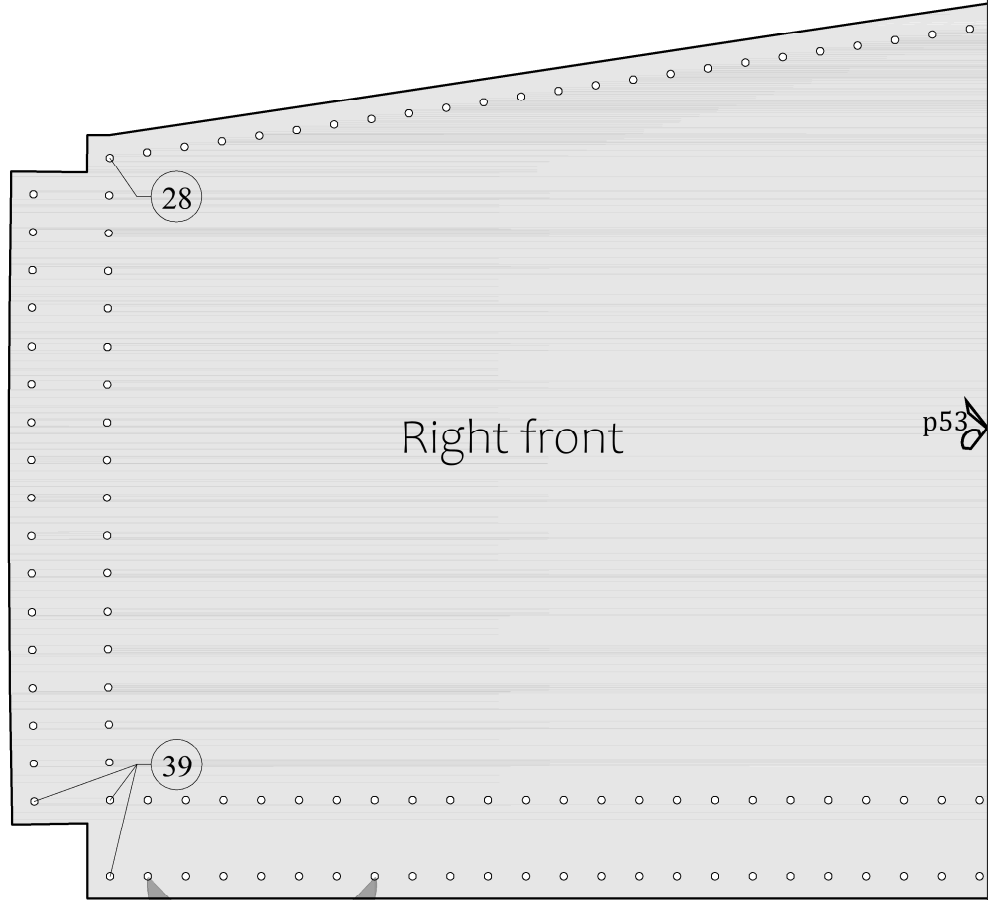
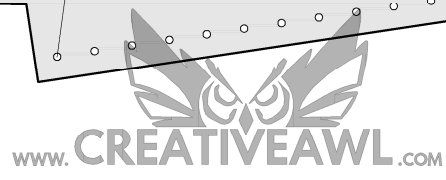

Right front

p53

28

39

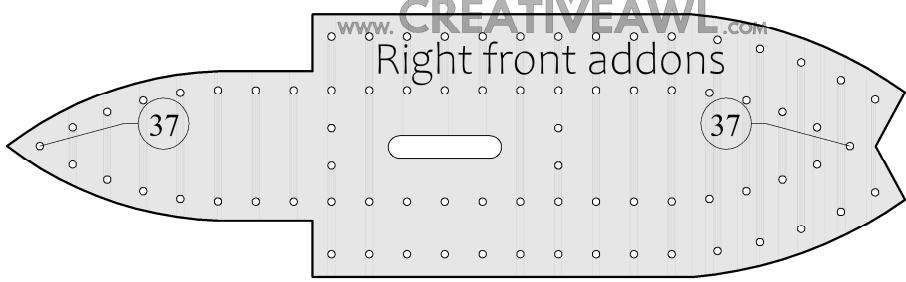

Right front addons

37

37

Ranger jacket
- size L -

11 in
LETTER
8,5 in

A4

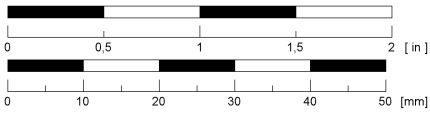

p50

Right front

p52

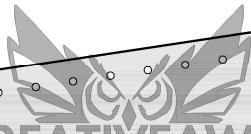

www.CREATIVEAWL.COM

p54

Right front

p53



www.CREATIVEAWL.COM

Right front addons

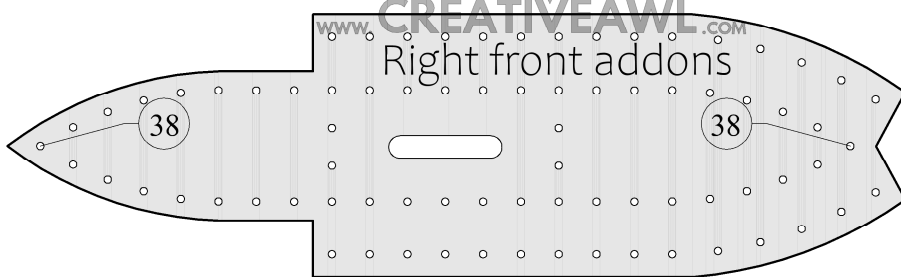

Ranger jacket

- size L -

11 in
LETTER
8,5 in

A4

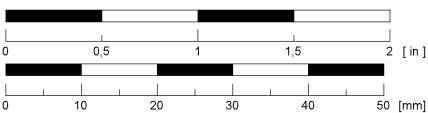

60

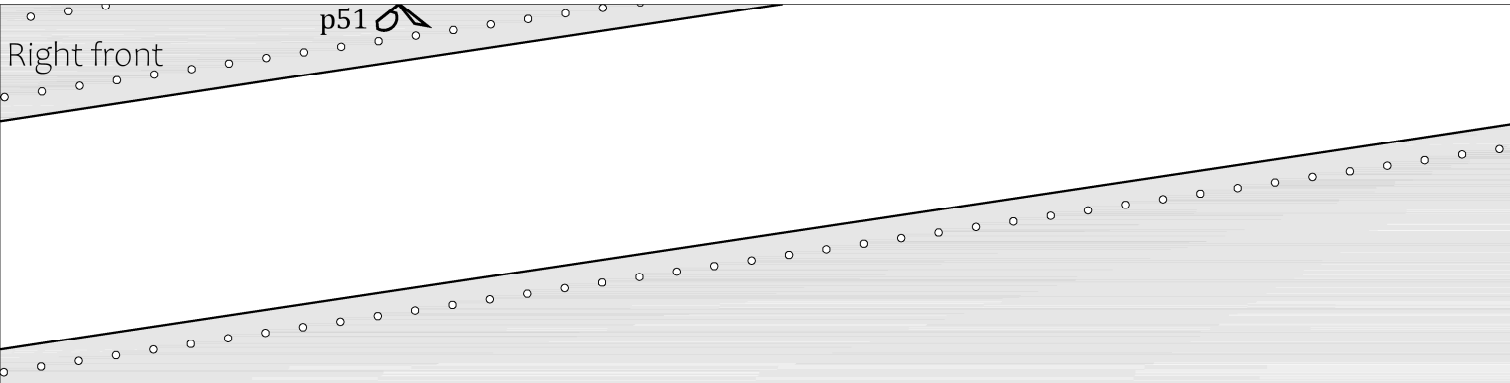

Right front

p51



p55

p54

Right front

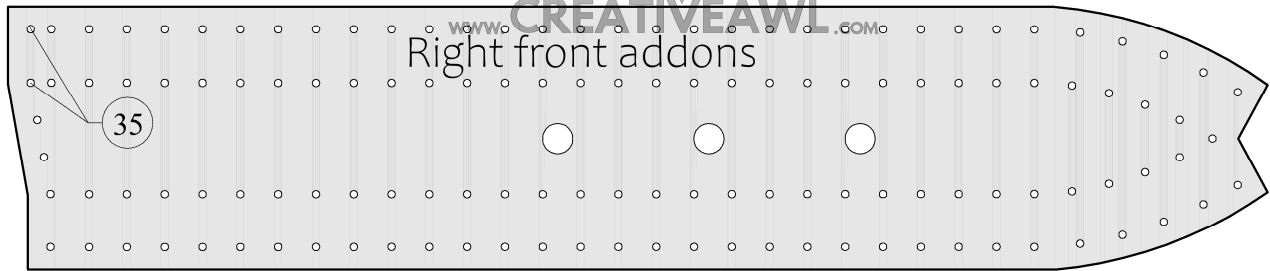

Right front addons

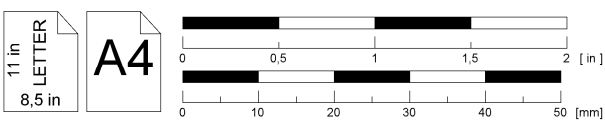

Ranger jacket
- size L -

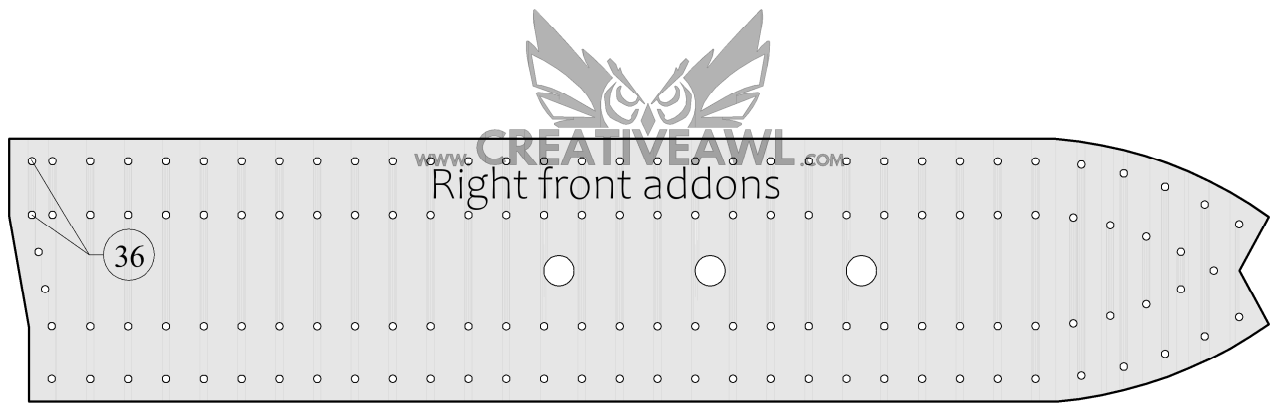
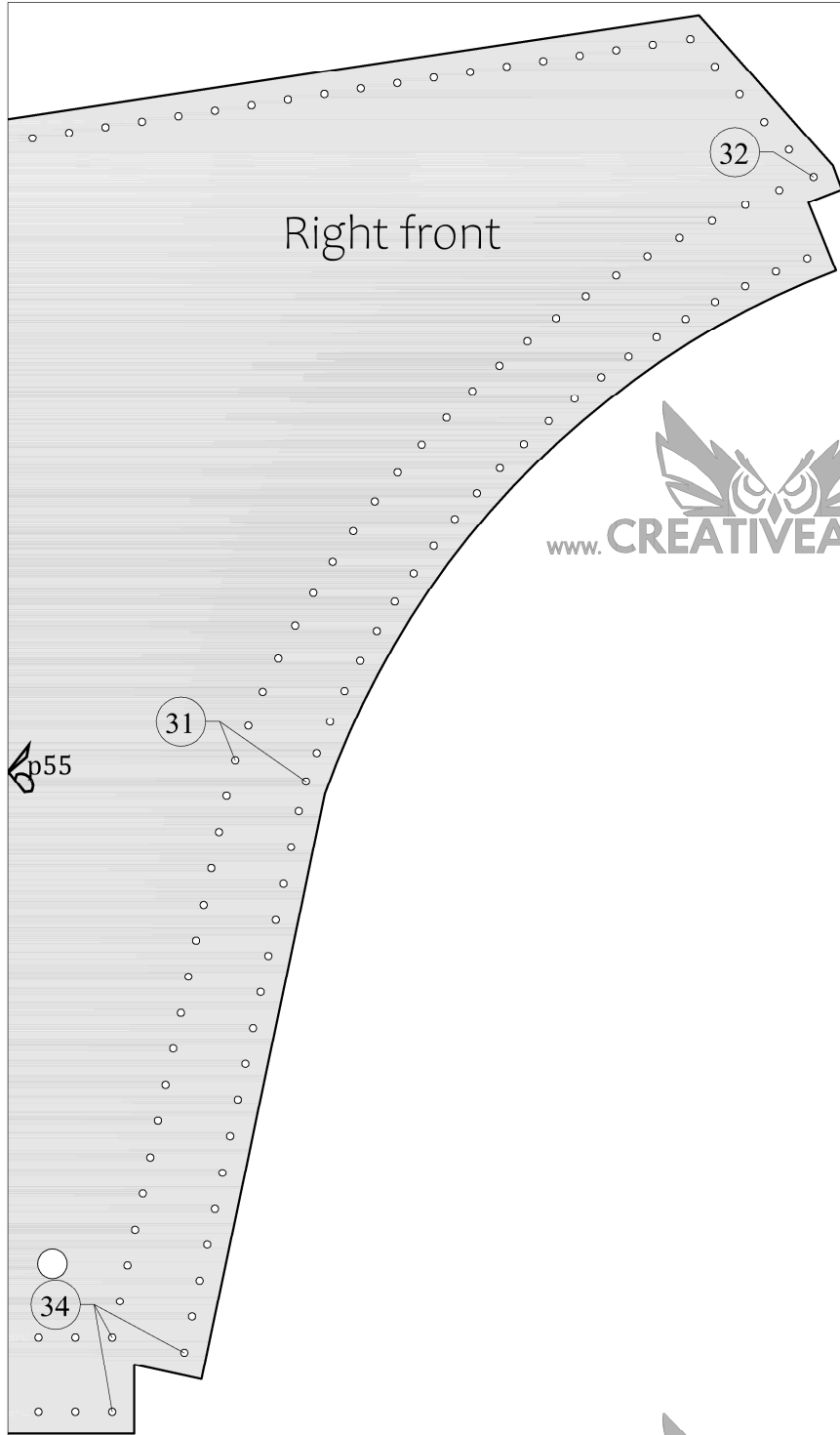

Ranger jacket
- size L -

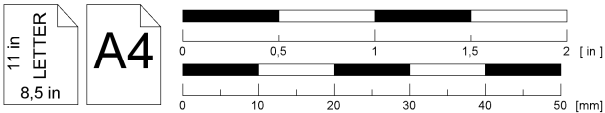

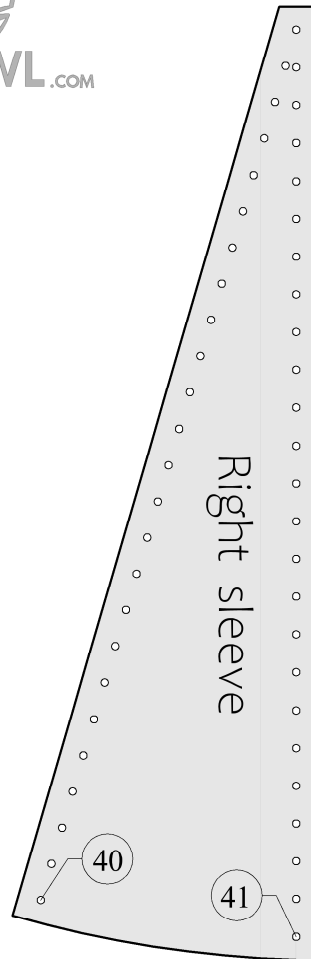
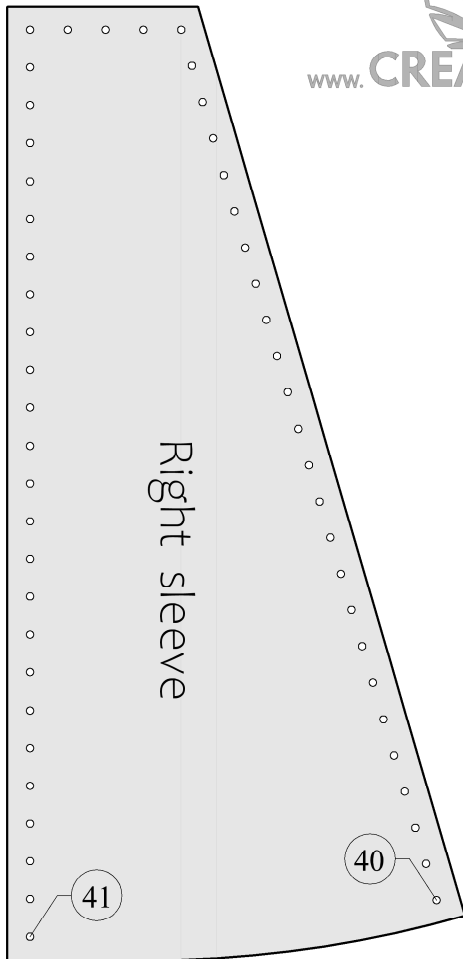

11 in
LETTER
8,5 in

A4

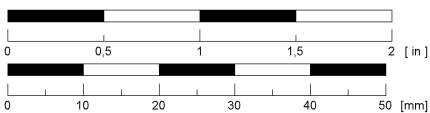

Ranger jacket
- size L -

11 in
LETTER
8,5 in

A4

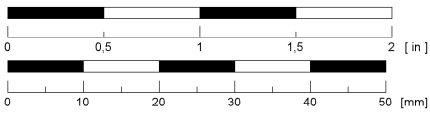

Ranger jacket - size L -

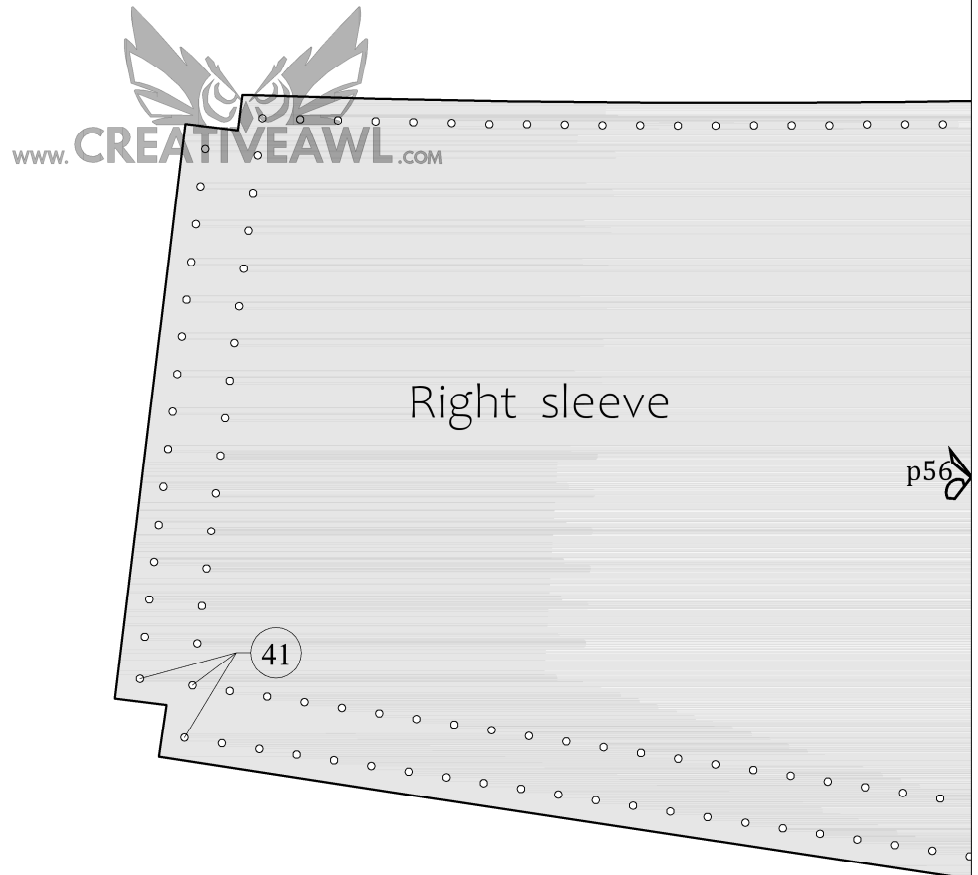

11 in
LETTER
8,5 in

A4

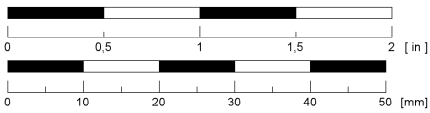

Ranger jacket - size L -

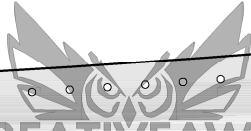

www.CREATIVEAWL.COM

p57

Right sleeve

p56

43



www.CREATIVEAWL.COM

43

Right sleeve

p59

p61

11 in
LETTER
8,5 in

A4

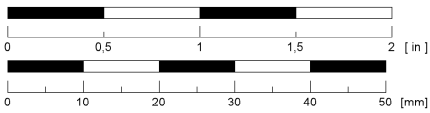

Ranger jacket - size L -

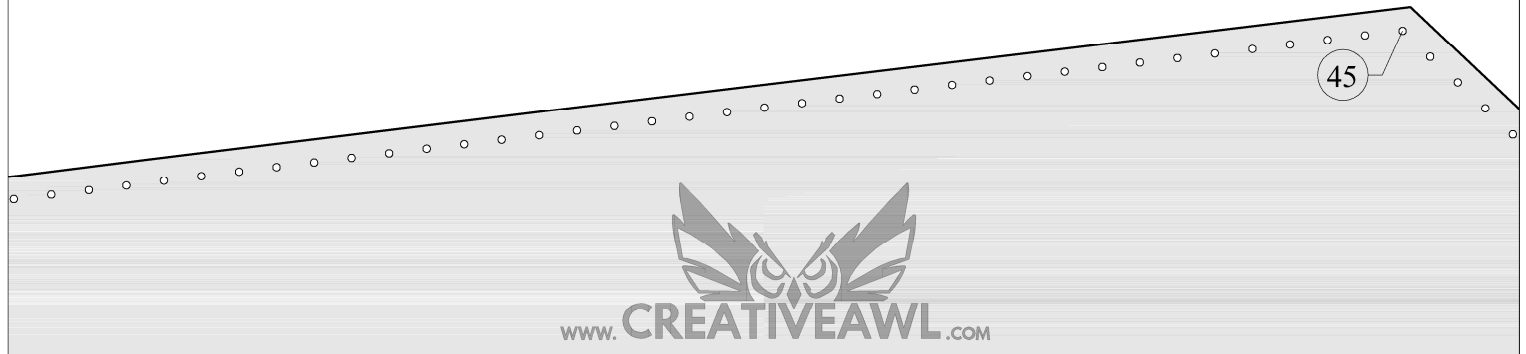

p57

Right sleeve

p58

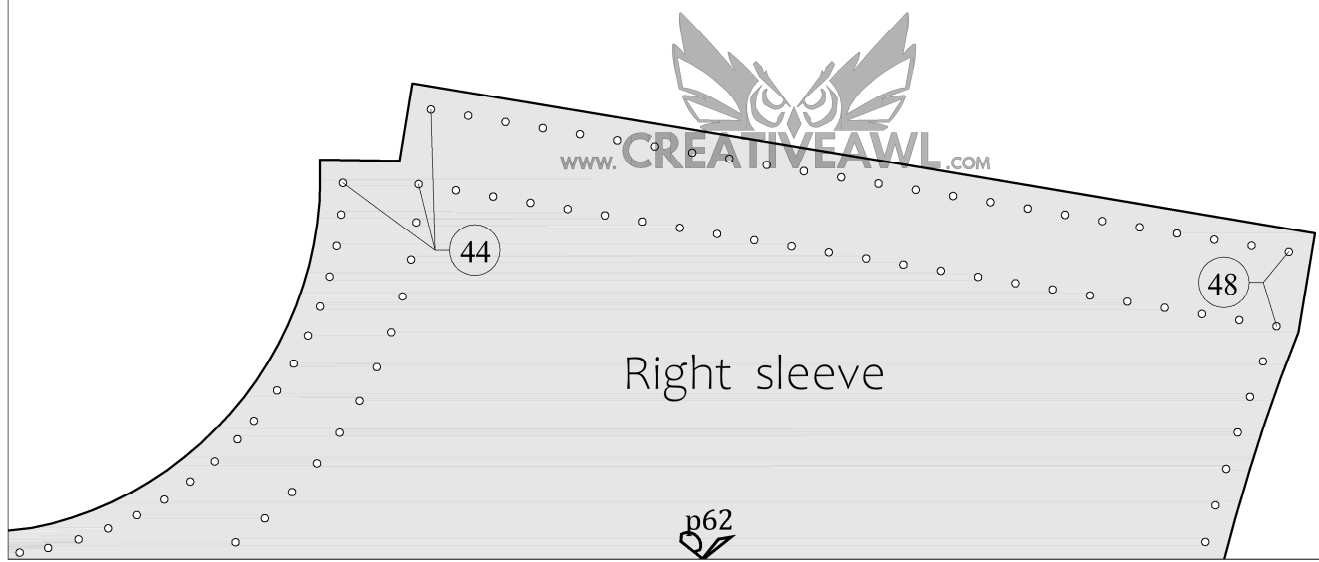
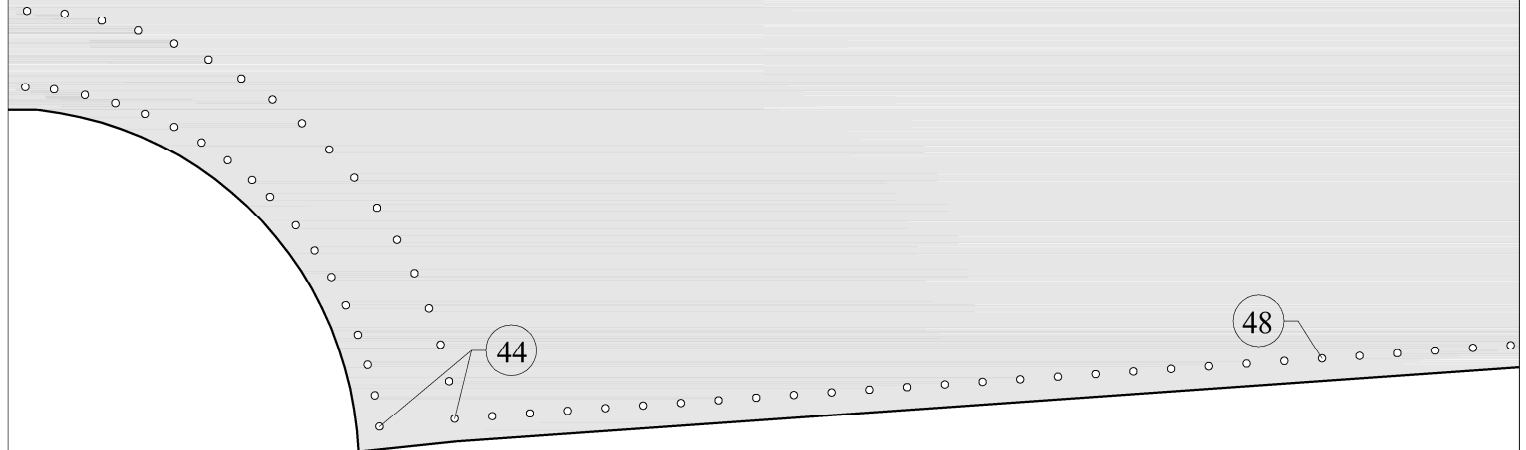

Right sleeve

p62

11 in
LETTER
8,5 in

A4

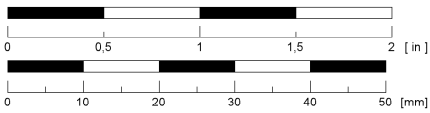

Ranger jacket - size L -

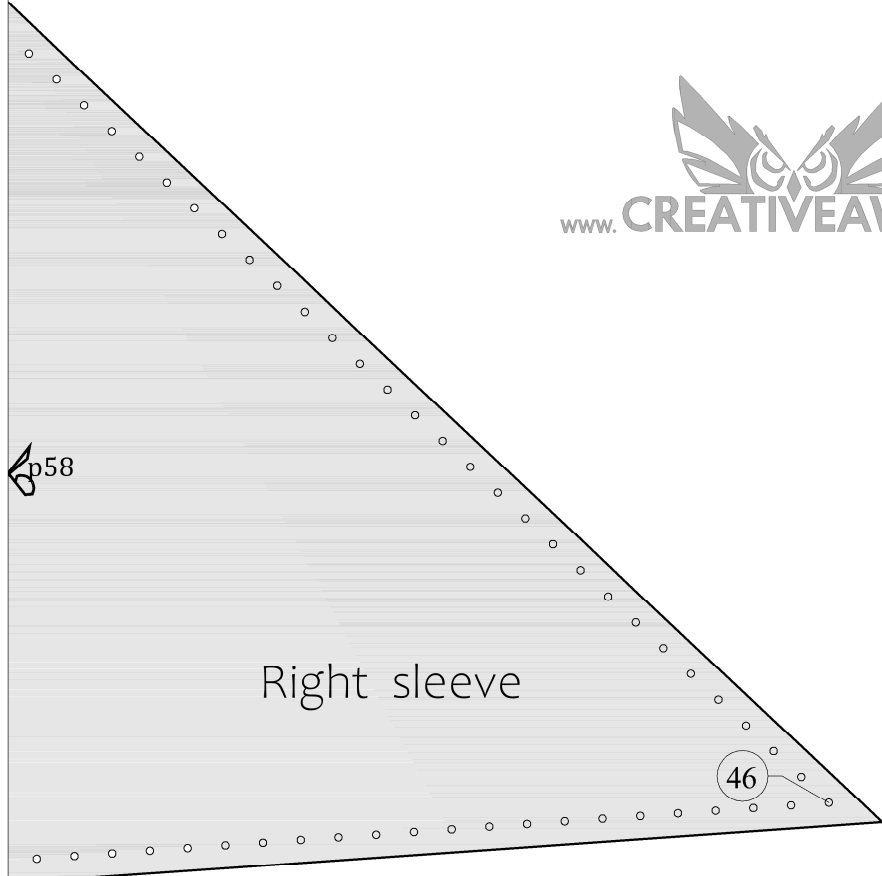

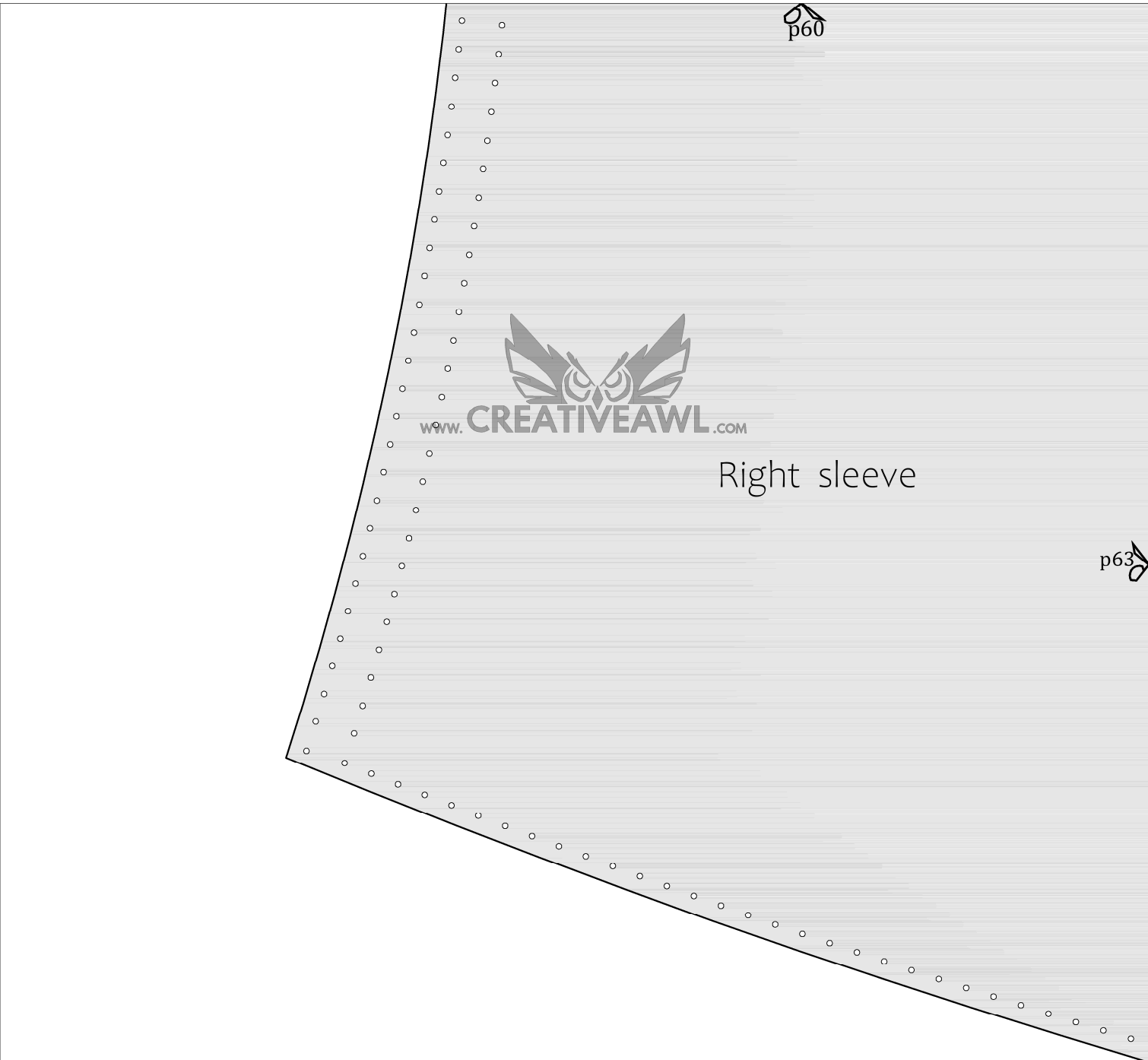

11 in
LETTER
8,5 in

A4

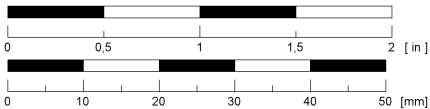

Ranger jacket
- size L -

p61



p63

Right sleeve

p64

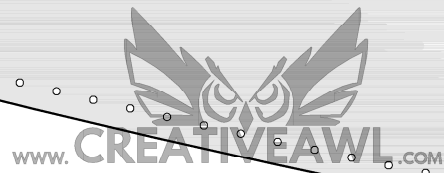

11 in
LETTER
8,5 in

A4

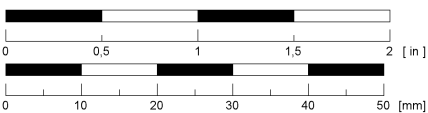

Ranger jacket
- size L -

p62



Right sleeve

p64



47

45

11 in
LETTER
8,5 in

A4

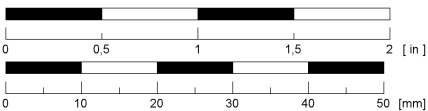

Ranger jacket
- size L -

70

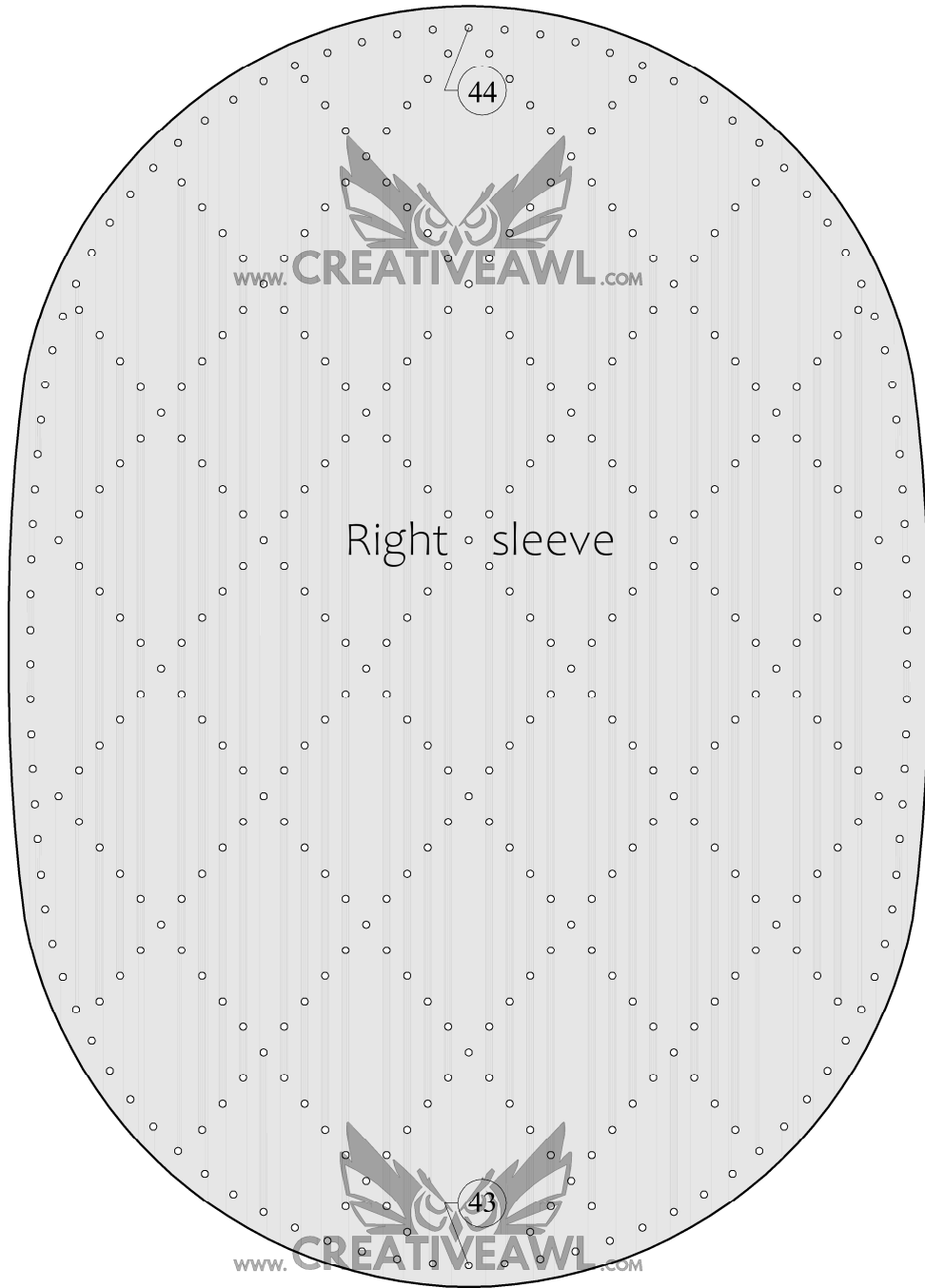

11 in
LETTER
8,5 in

A4

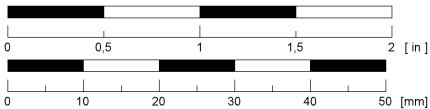

Ranger jacket
- size L -

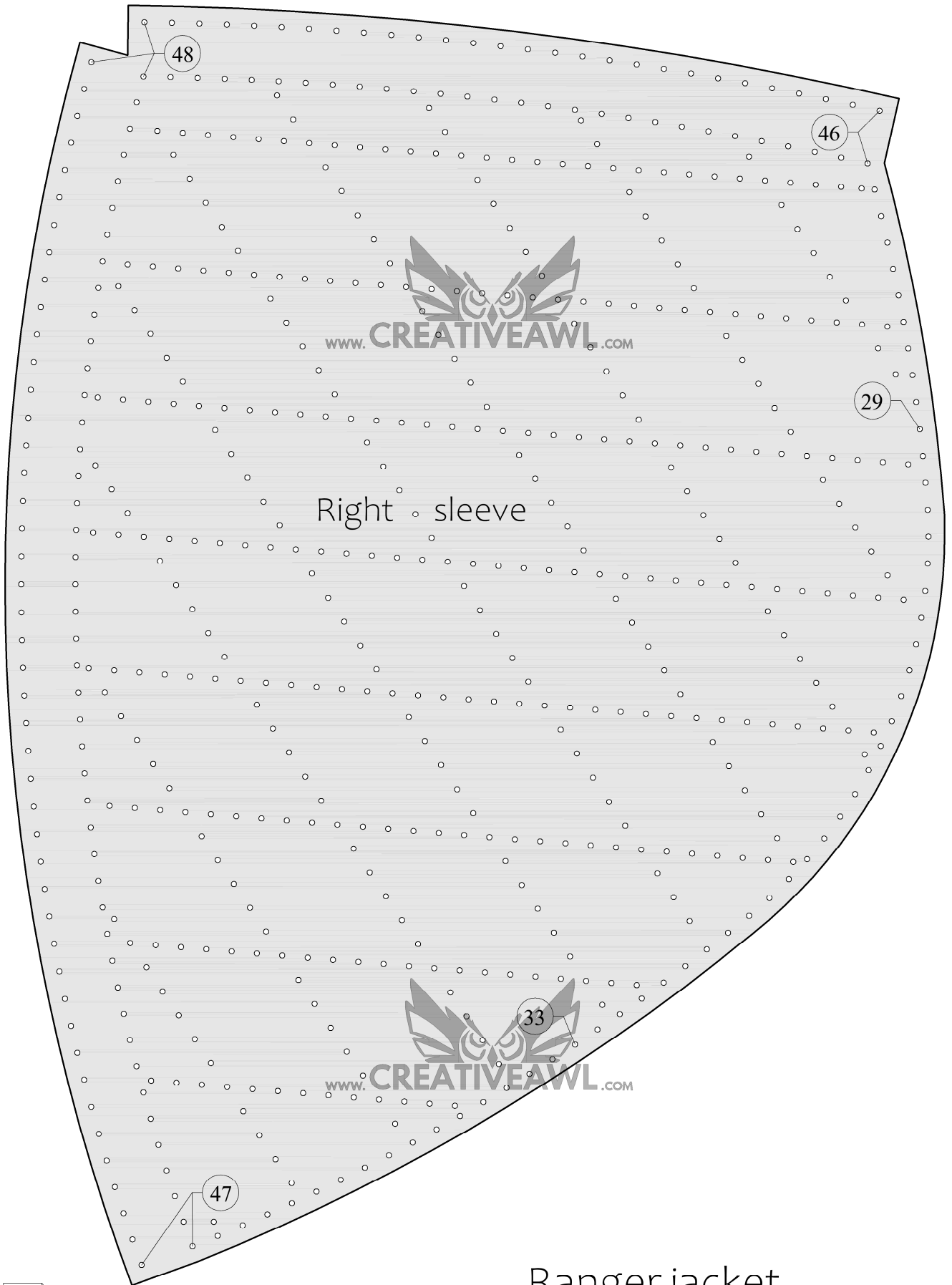

www.CREATIVEAWL.COM

Right sleeve

www.CREATIVEAWL.COM

11 in
LETTER
8,5 in

A4

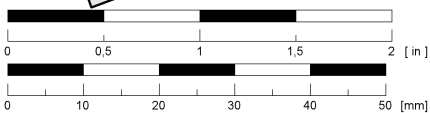

Ranger jacket
- size L -

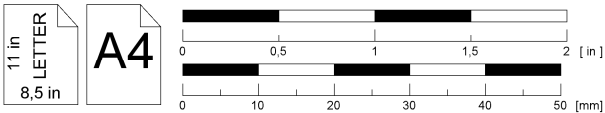

Ranger jacket
- size L -

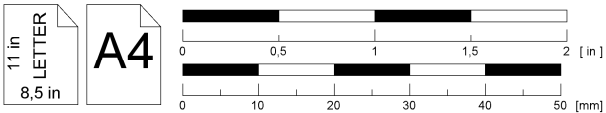

Ranger jacket
- size L -



www.CREATIVEAWL.COM

Top right pocket

26

www.CREATIVEAWL.COM

11 in
LETTER
8,5 in

A4

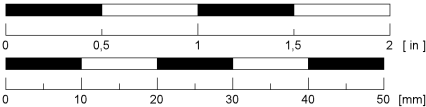

Ranger jacket

- size L -

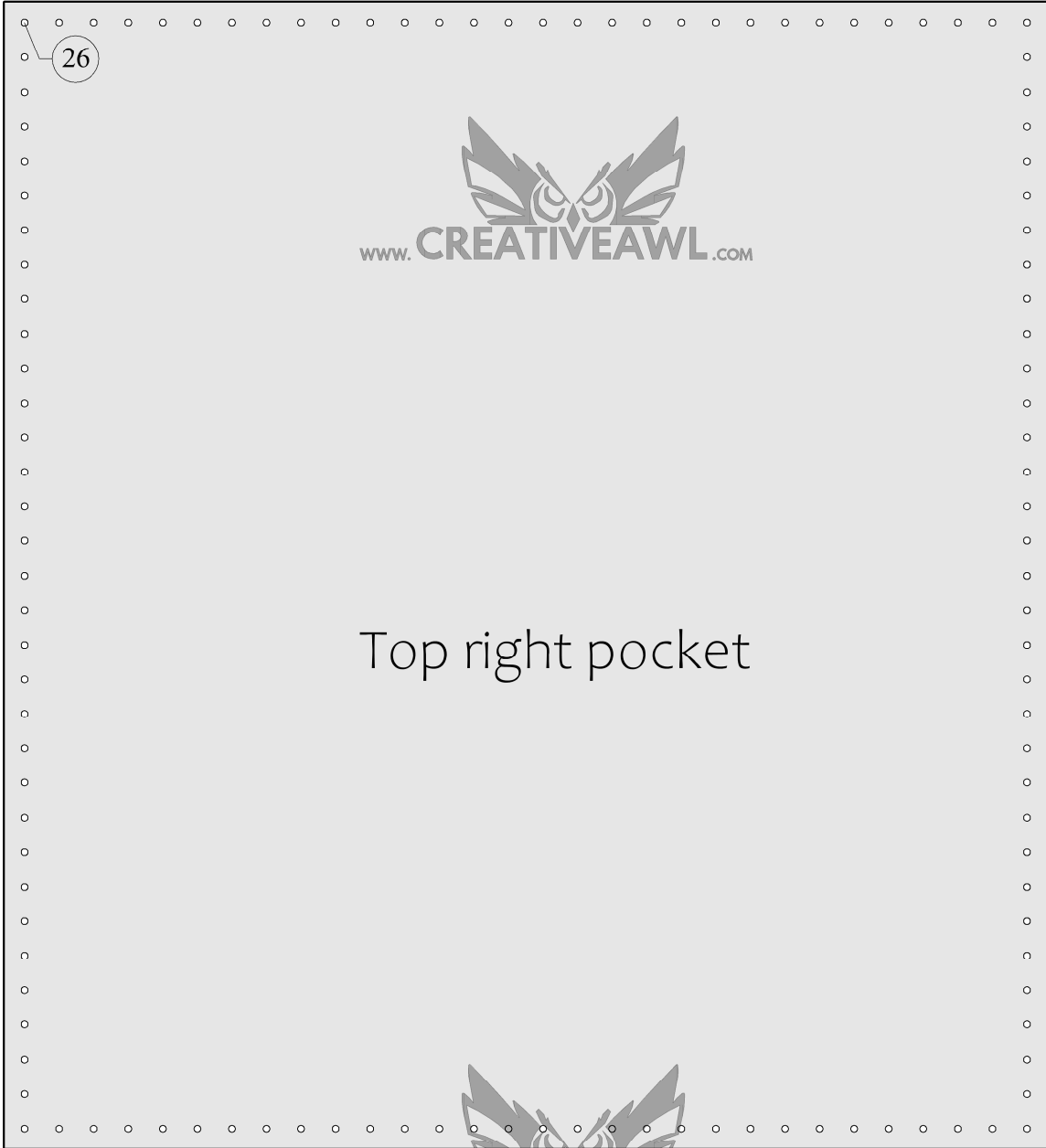

26



Top right pocket



11 in
LETTER
8,5 in

A4

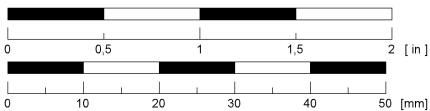

Ranger jacket
- size L -

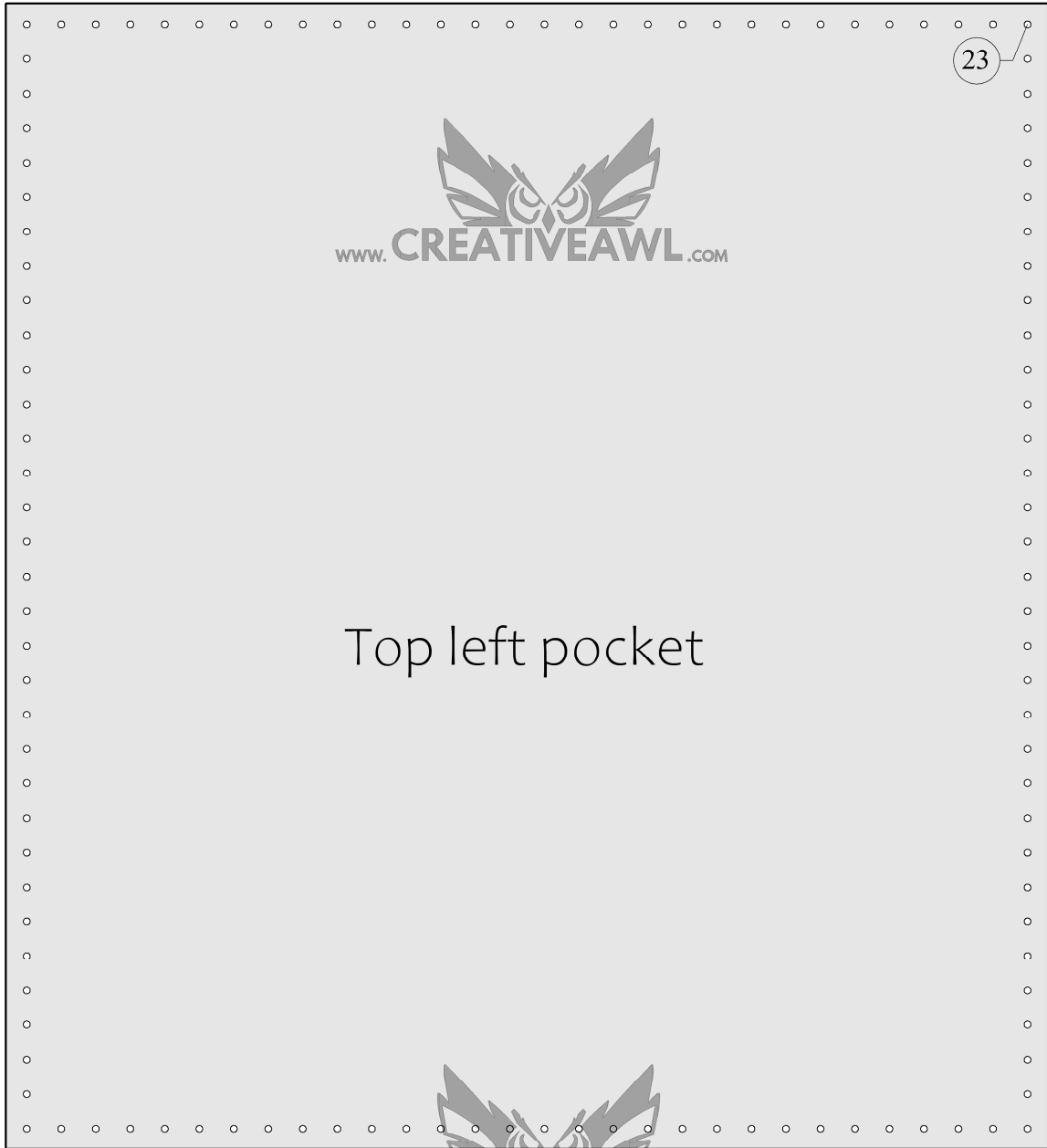

Top left pocket



11 in
LETTER
8,5 in

A4

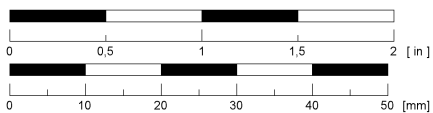

Ranger jacket
- size L -



Top left pocket

23



11 in
LETTER
8,5 in

A4

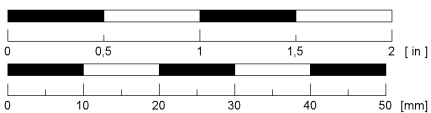

Ranger jacket
- size L -

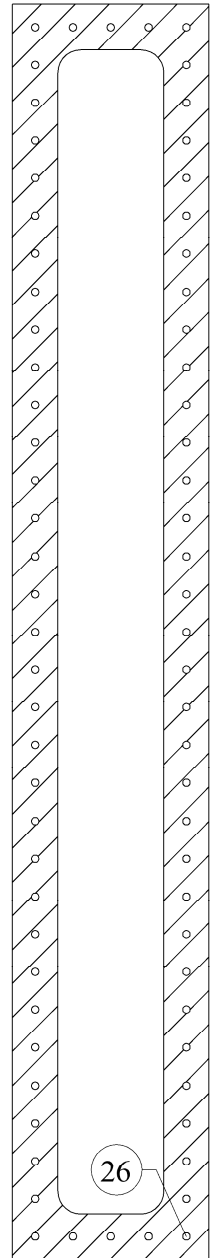
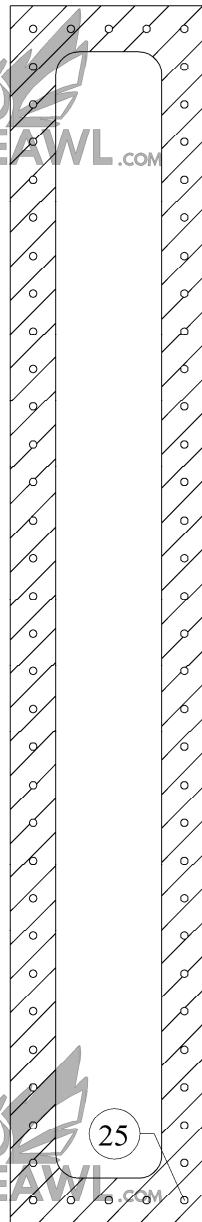
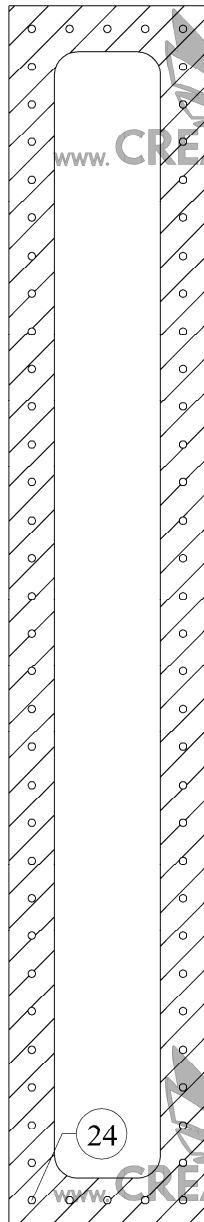
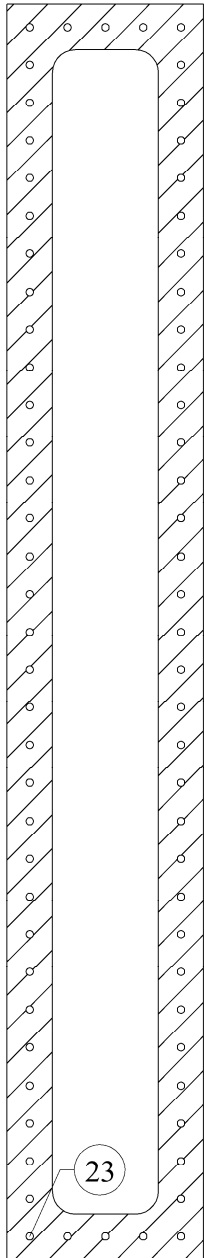

Zip template

Ranger jacket
- size L -

