

[Video tutorial](#)

[Facebook community](#)

[Website](#)

[Etsy patterns shop](#)

[Instagram](#)

Knight helmet pattern

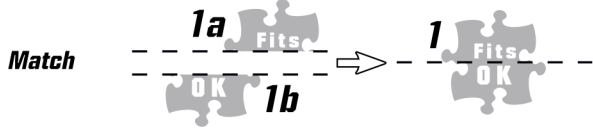
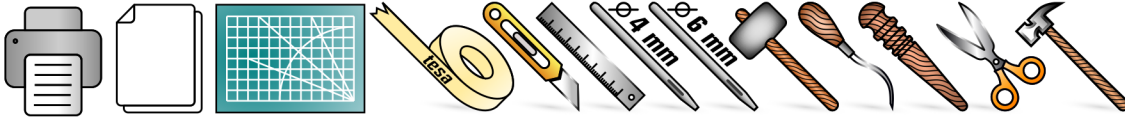

Punch



Cut

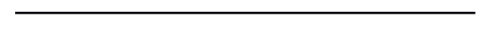

* Print on any type of paper selecting **US Letter** as the printing format.

* For headwear patterns, measure your head from the back to the forehead to get the size you need.

* You will also require 60 rivets long enough to be set through three layers of thicker leather.

Print at **100% scale** for approximately
630 mm in head circumference or **US size 7 7/8**
and measure the ruler from below for accuracy.
For other sizes please consult the remaining options.



Print at **98.4%** for **620 mm** or **US size 7 3/4**

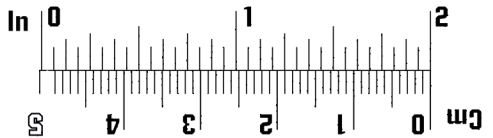

Print at **90.3%** for **570 mm** or **US size 7 1/8**

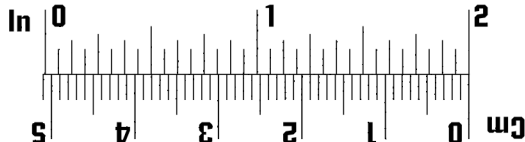

Print at **96.8%** for **610 mm** or **US size 7 5/8**

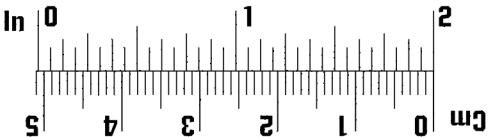

Print at **88.7%** for **560 mm** or **US size 7**



Print at **95.2%** for **600 mm** or **US size 7 1/2**

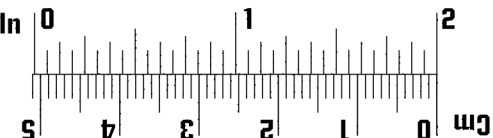

Print at **87%** for **550 mm** or **US size 6 7/8**

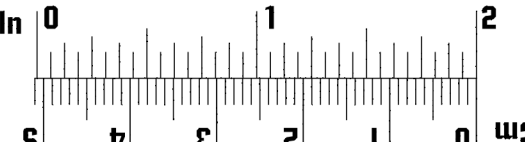

Print at **93.5%** for **590 mm** or **US size 7 3/8**



Print at **85.5%** for **540 mm** or **US size 6 3/4**

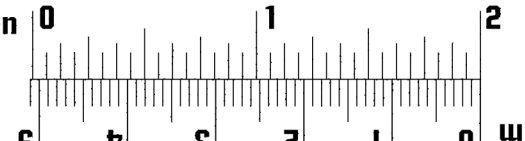

Print at **91.9%** for **580 mm** or **US size 7 1/4**



Print at **84.1%** for **530 mm** or **US size 6 5/8**

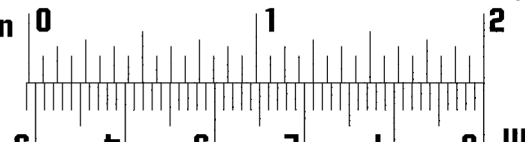

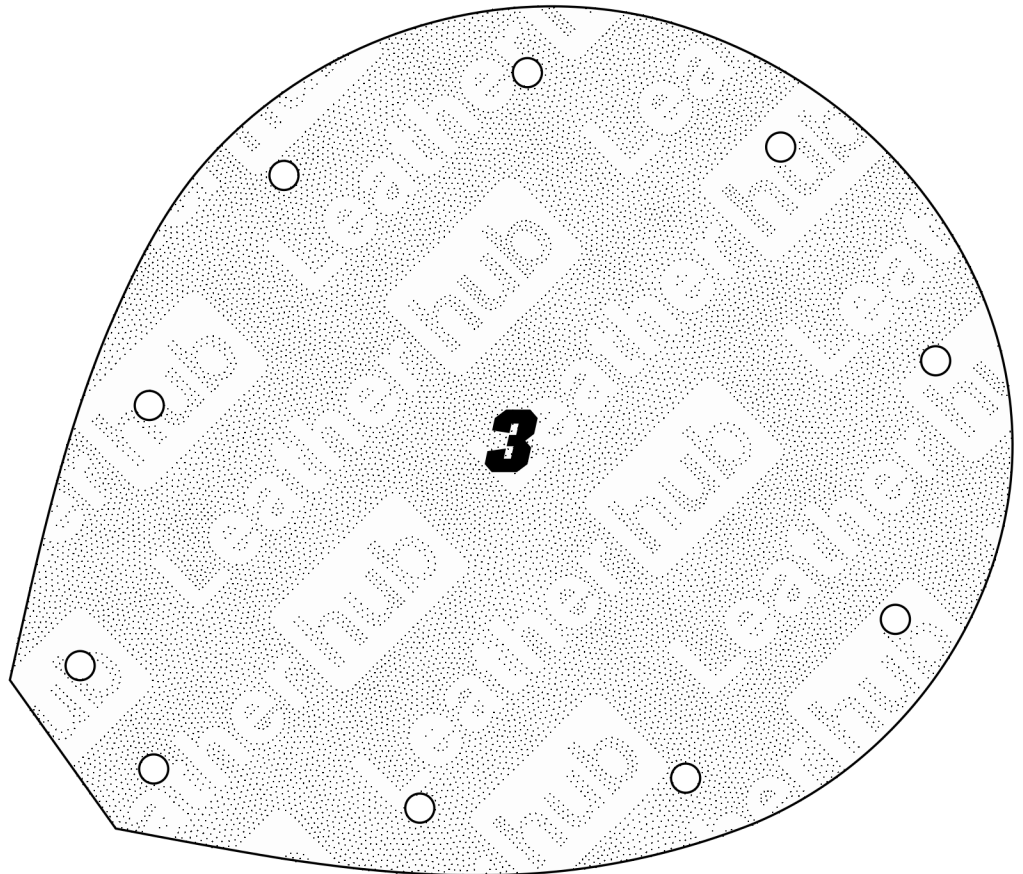
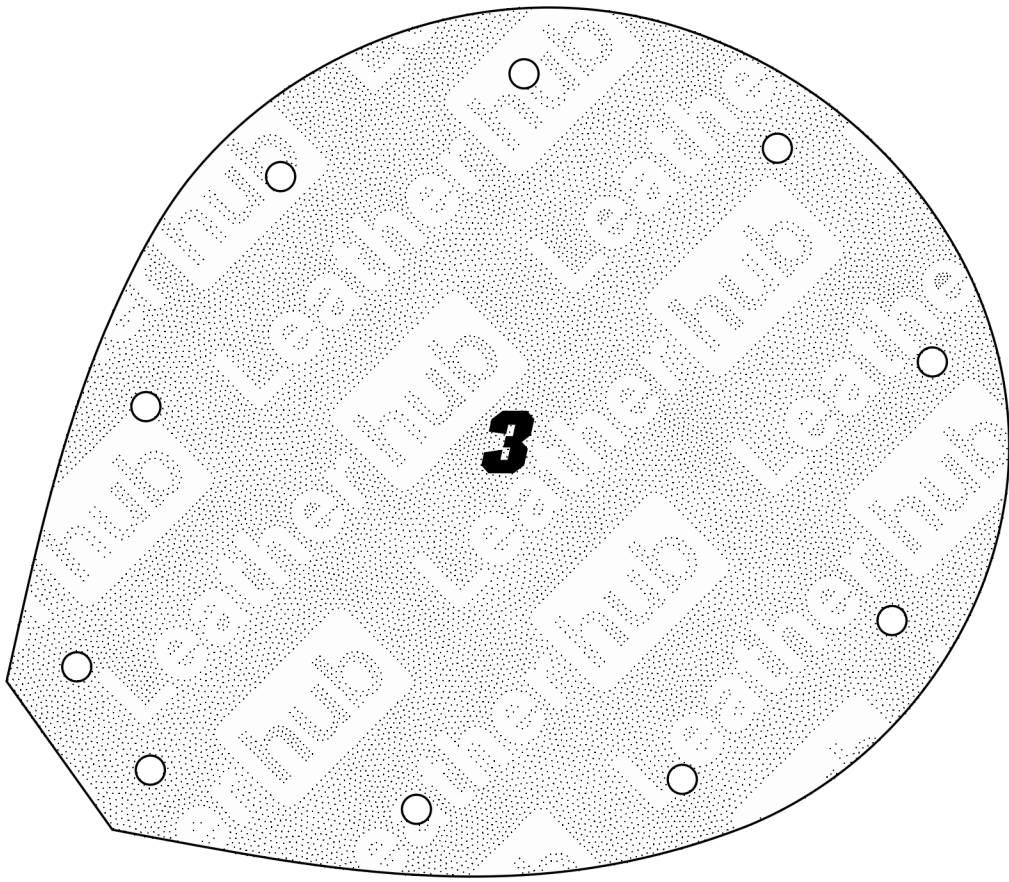

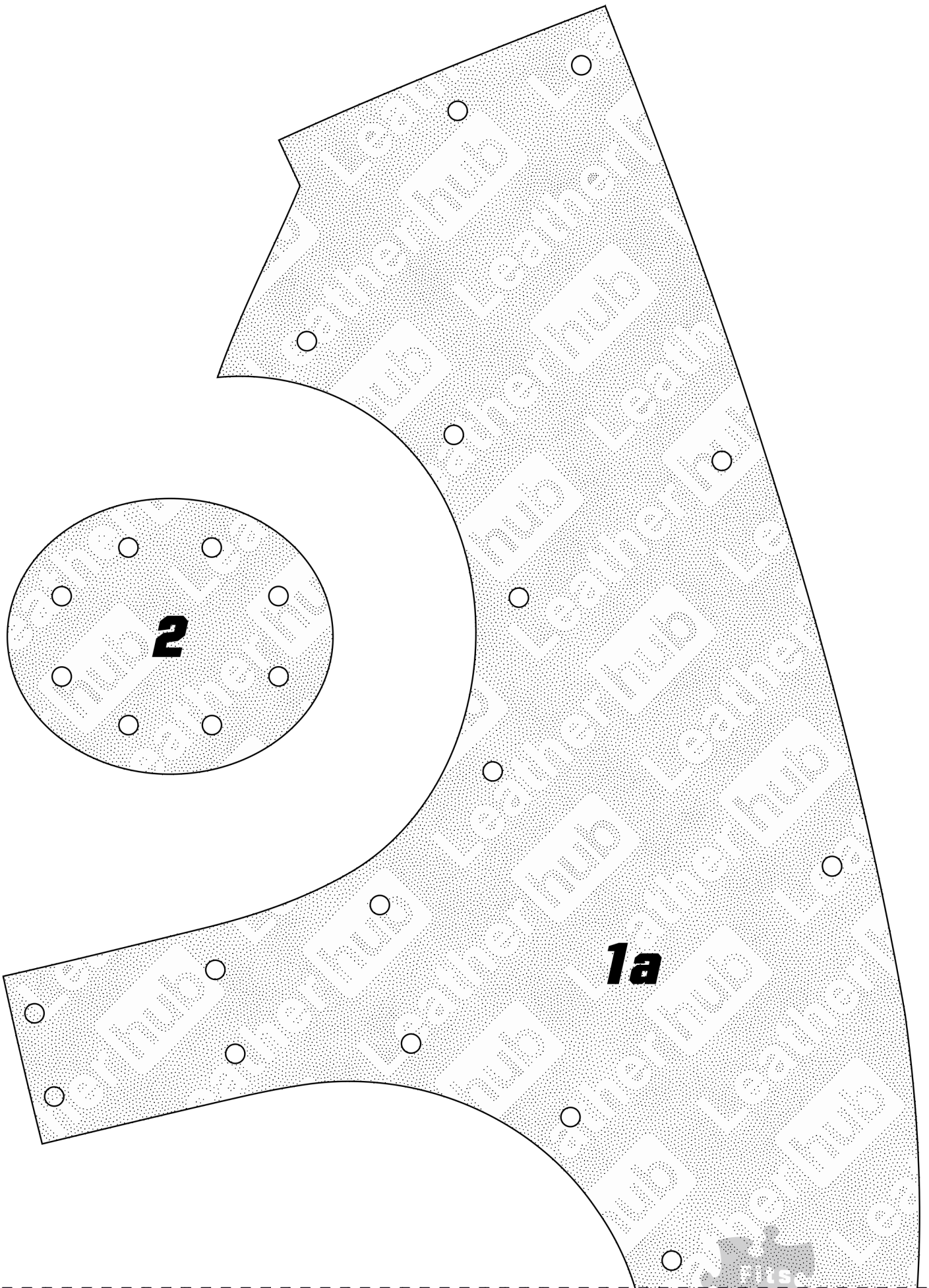

2

1a

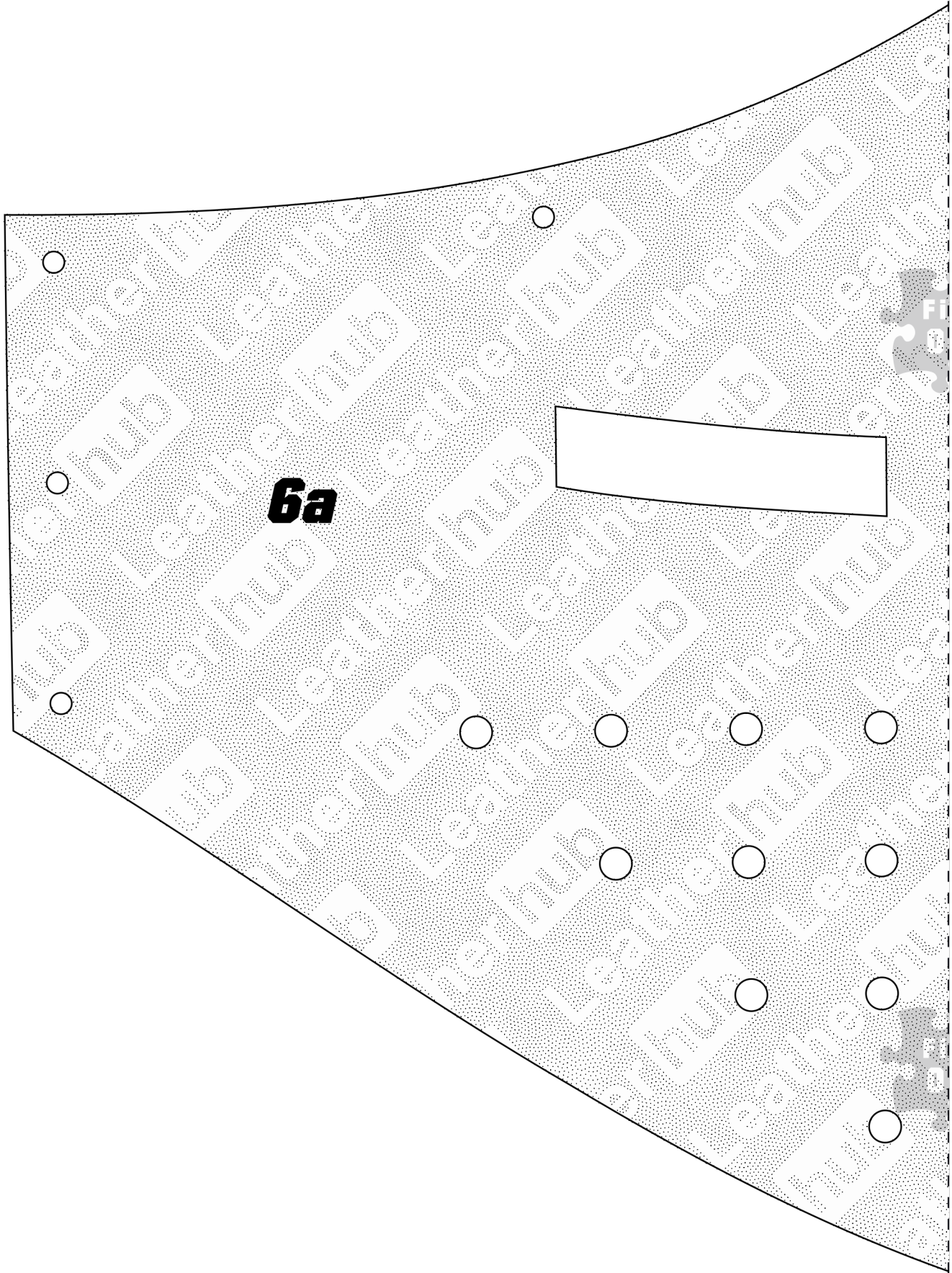

6a

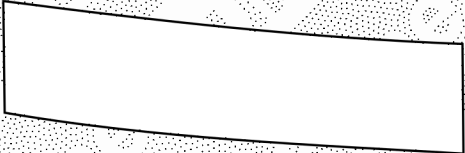

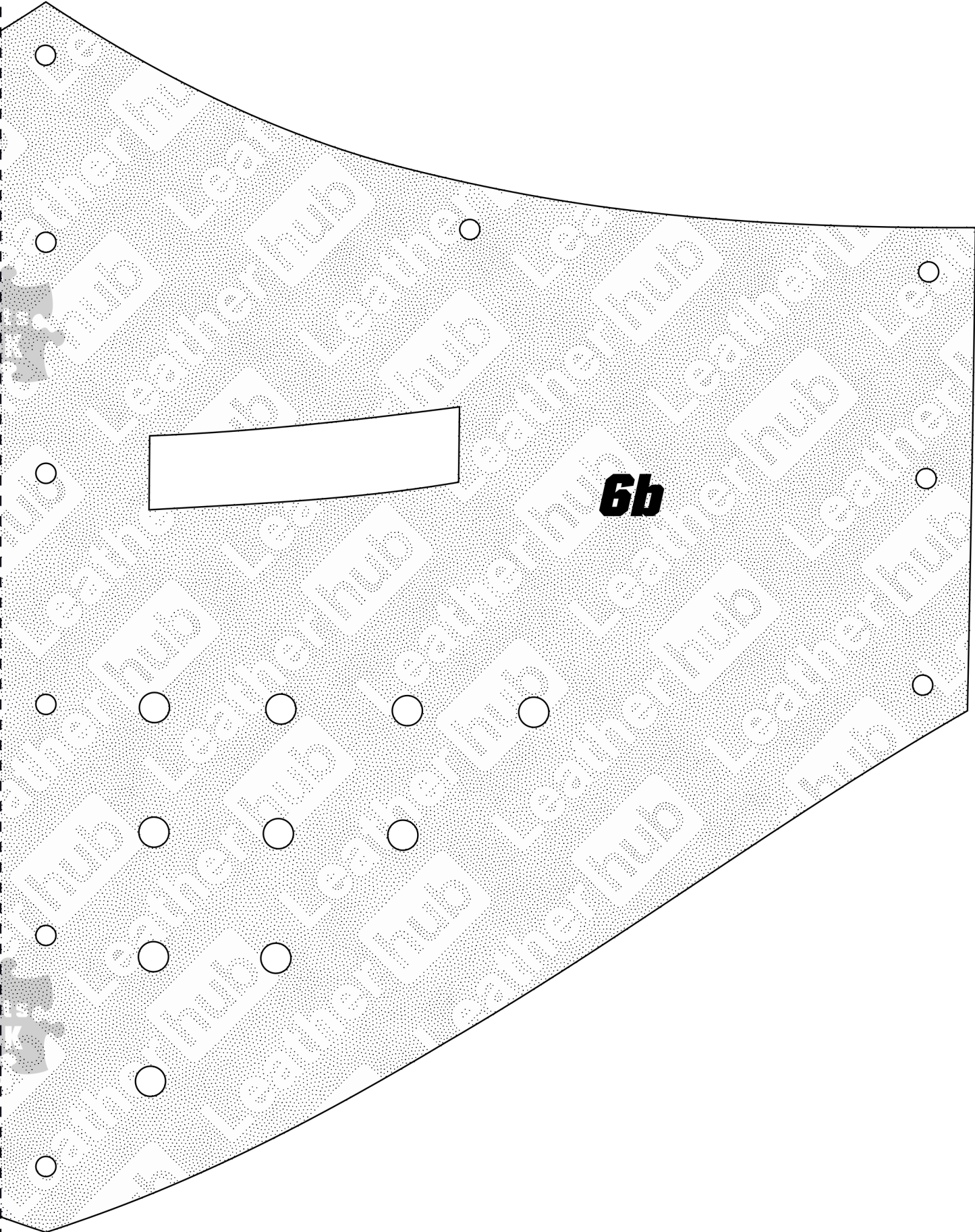

6b

1d

4

5a

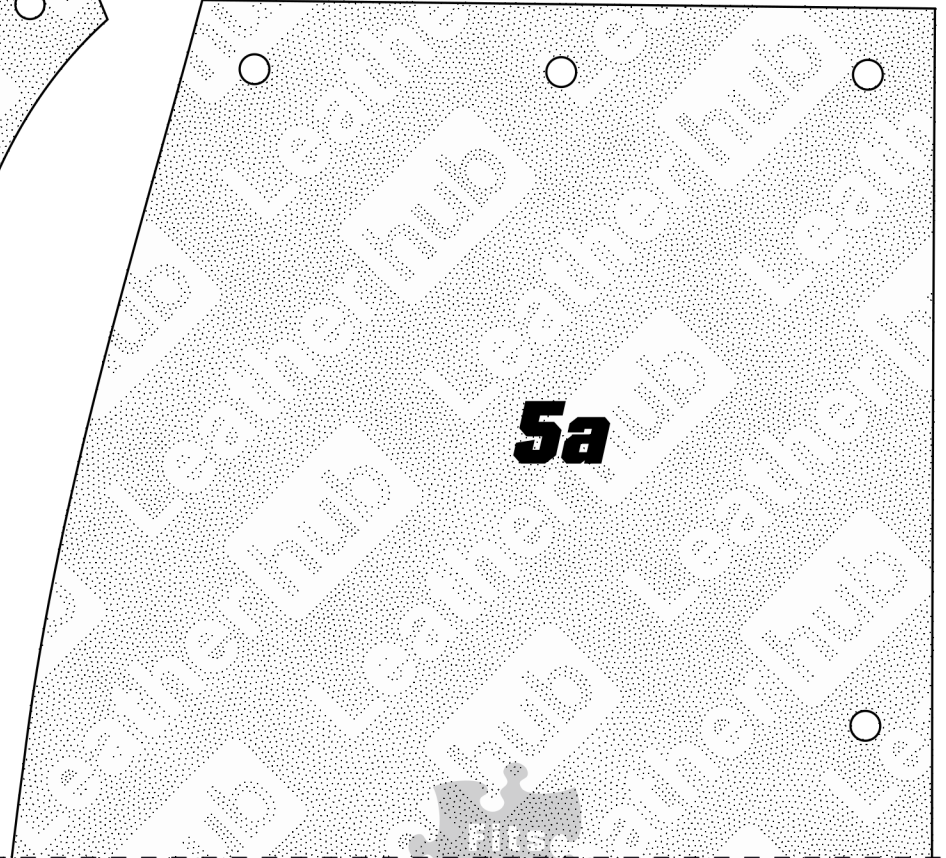
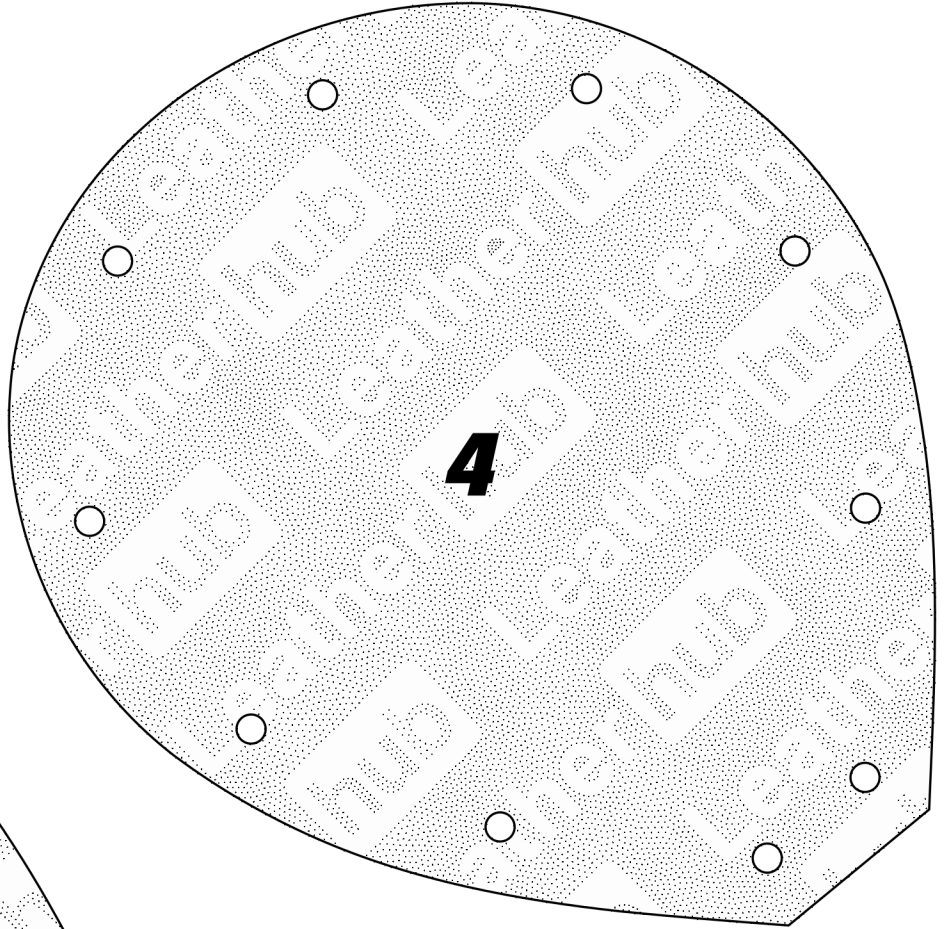
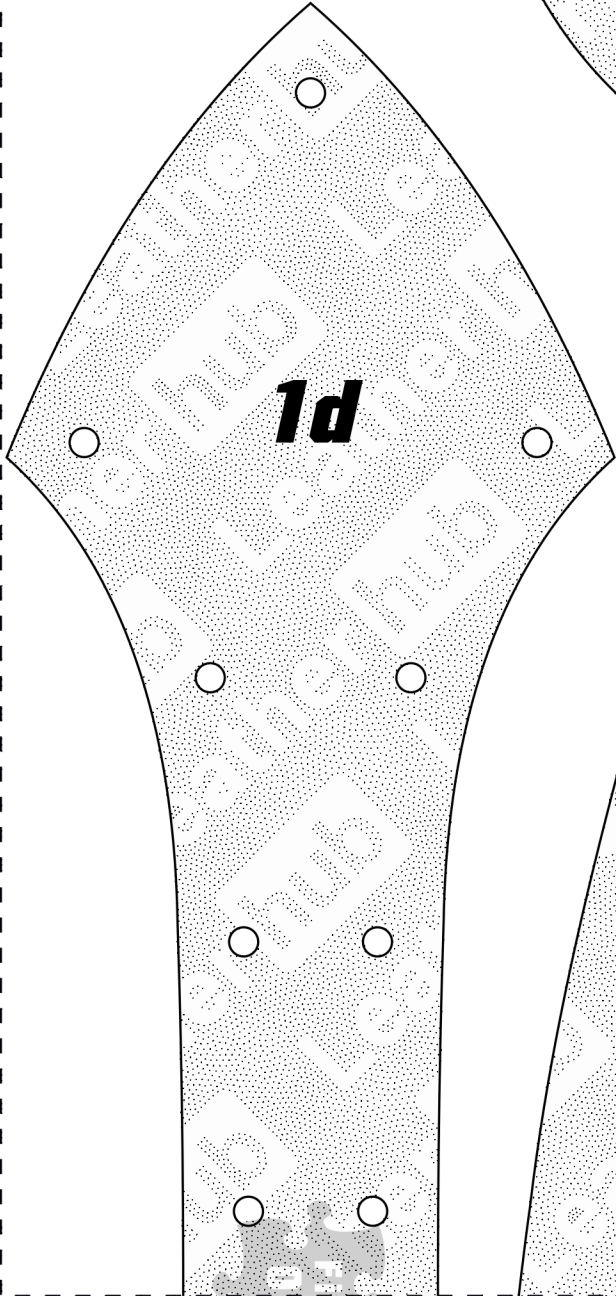

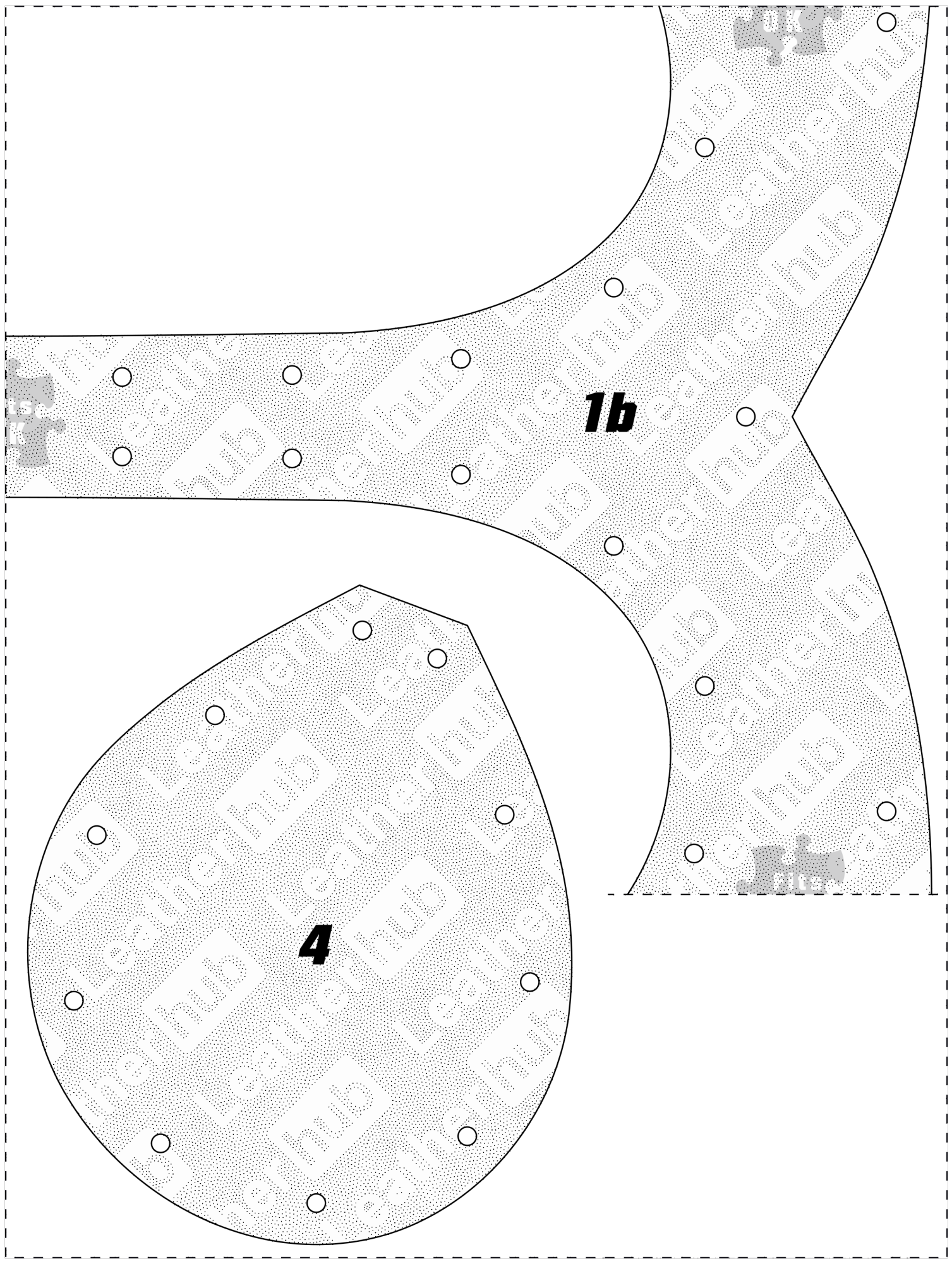

1b

4

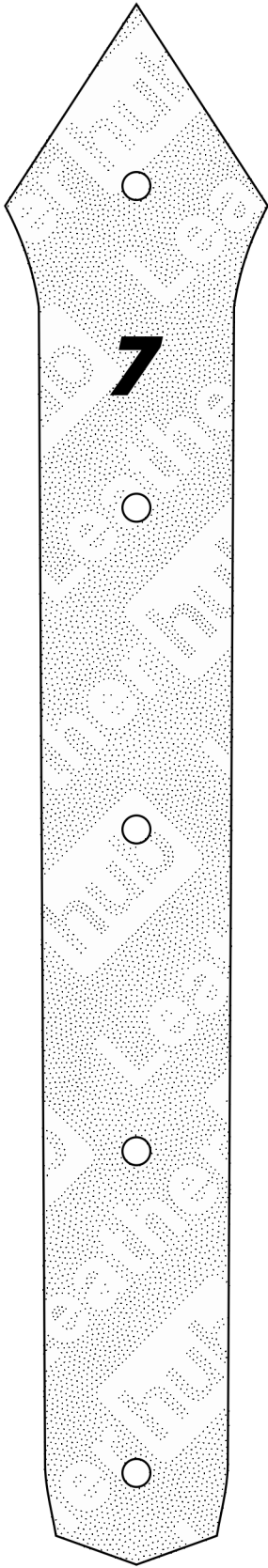

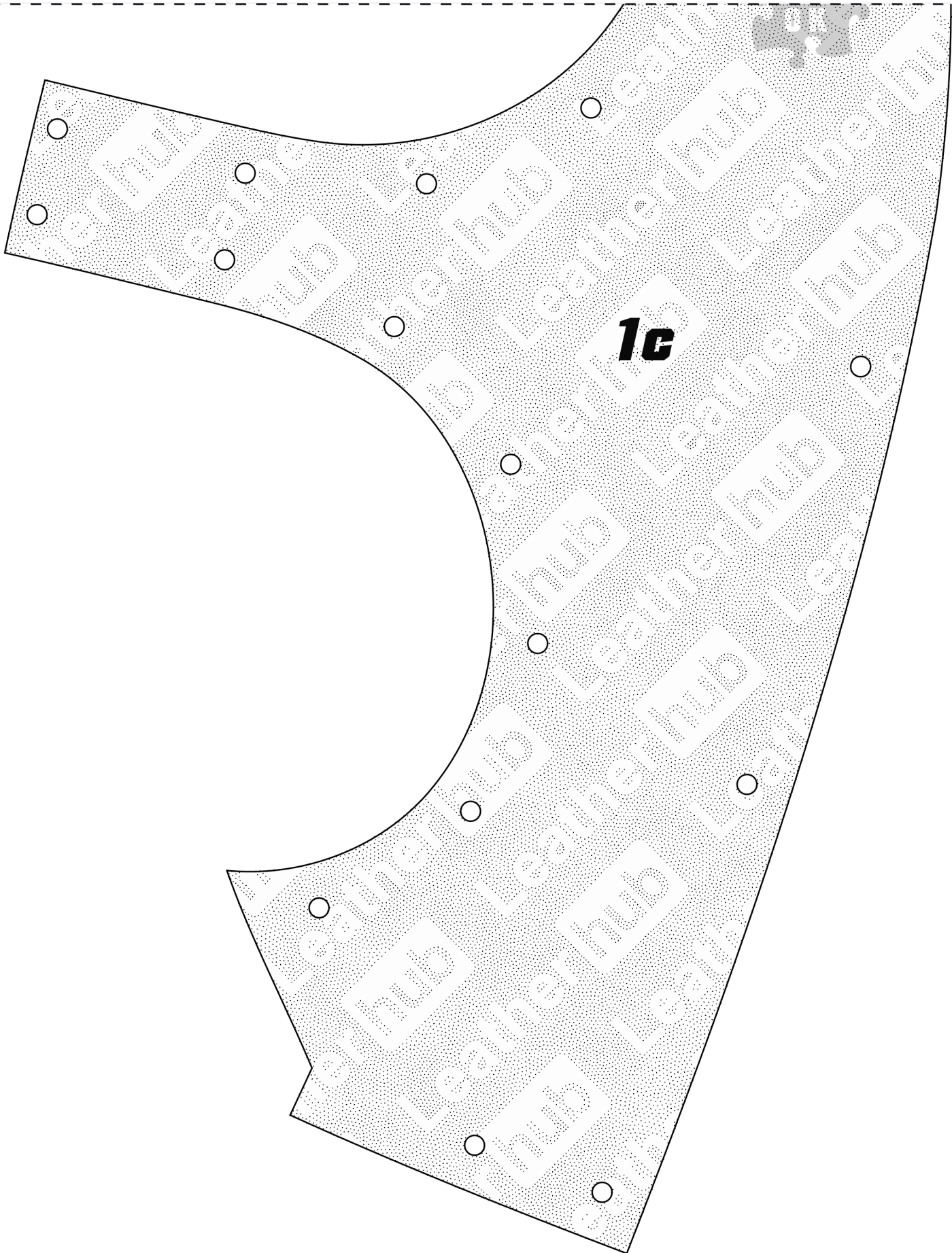

1c