

Patterns for bucket bag for men (L04-0001) 26W x 45H x 26D cm



⚠ IMPORTANT NOTES. PLEASE READ BEFORE YOU START ⚠

- Go through the instruction before you transfer and cut the patterns. It will help you understanding the patterns and giving you a general idea on what will be doing. Don't hesitate to contact us if you have any problems with the patterns - Your input will help us to improve the patterns/instruction.
- We usually provide full-scale patterns except for patterns such as shoulder strap which may be too long to print. We will specify it in the patterns. Always read carefully the pattern symbols, you may need to mirror the patterns, or do some cut and glue works to join the patterns before you can use it.
- To print full-scale patterns, you have to set the print scale to 100%, or print it at actual size. A4 paper is used for small leather goods, and A3 paper is used for large leather items. We will specify the paper size in section 1 of the instruction.
- Follow the instruction. DO NOT PUNCH ANY HOLES FIRST.
- The materials and tools listed in this instruction are for reference only. You may need to adjust the thickness of leather or size of hardwares according to your favours.
- Feel free to modify the patterns but we strongly suggest that you should test the modified patterns using paper or fabric mock up.
- The patterns and instructions are only for personal use and are not permitted to be used for commercial purpose. Please do not resell, reproduce, distribute by any means or profit in any way.

FAQ FOR THIS PATTERNS

Question: Is it better to pierce holes (such as stitching lines and rivet holes) right after die cutting the leather pieces?

Answer: NO! The stitching lines or rivet holes shown in the patterns are for reference only. Sometimes it is better for you to glue and fold the leather pieces before piercing holes due to better alignment. Therefore, you should always pierce holes according to the instruction.

UNDERSTANDING PATTERN MARKINGS

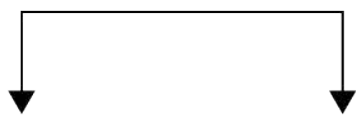

On the Fold : This mark indicates the pattern piece only embodies half of the fabric/leather piece, it should be positioned along the fold of fabric/leather to create of a whole, proportioned piece.



Stitching Line : It is where you should sew. The seam allowance we usually use is 3/4/5mm in from edge.
Read our instruction for details.



Adjustment Line : This marking features two heavy, bold lines running parallel. It is where you can shortened or lengthened the patterns.
Due to printing size limitation, this is often be used on long straps for our patterns. Follow the recommended size to create a complete pattern.

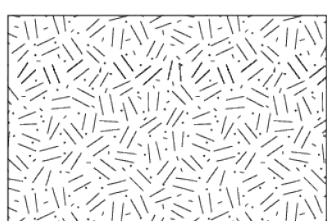

Flesh side of leather

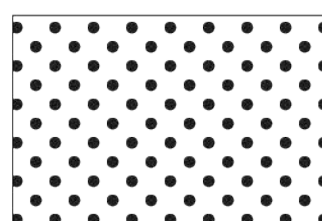

Glue area

MATERIALS NEEDED

ingenious design



2mm (5oz) veg-tan leather
(Color A)



2mm (5oz) veg-tan leather
(Color B)



Waxed thread



Contact adhesive glue



Zipper



6mm Double cap rivet x 5



9mm Single cap rivet x 3



9mm Double cap rivet x 5



27mm inner width
Pin buckle x 2



27x 10mm inner size
Rectangle ring x 2



35mm Outer ring x 2
(25mm Inner ring)



17mm Eyelet x 16
(Inner diameter 10mm)

TOOLS NEEDED



4mm Diamond chisel



Cutting mat, steel ruler
and sharp knife / cutter



Hand stitching needles
for leather



Adjustable edge creaser



Hammer



Leather marker pen



3mm & 8mm Hole puncher



Rivet punching tool



Eyelet punch tool



Bulldog clips

PREPARE THE LITTLE PIECES FIRST

Before punching the stitching lines and rivet holes, let's prepare all the little pieces first.

Tips: Any smooth surfaces are roughened up with sand paper before the glue is applied to give a firm bond.

1.1 Strap holders

- Burnish the edges for the following patterns:

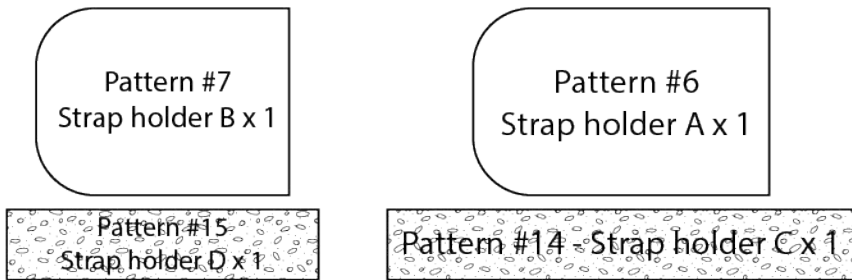

- Cut a 2.5cm slot at the center:

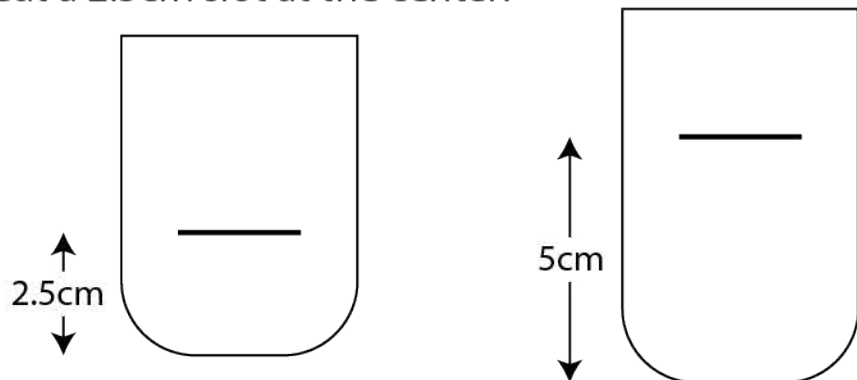

1.2 Strap holders

- Fold the following patterns into half, add the ring and insert to the slot:

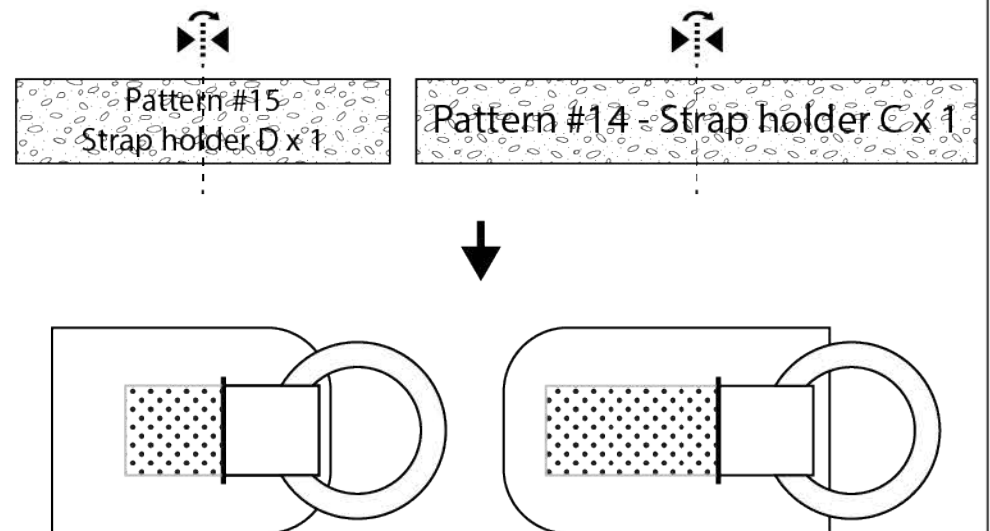

- Use glue to secure the inserted parts in place.



2.1 Sew the zipper

- Work on the back panel (Pattern #8)
- Cut a slot for the zipper. Burnish the slot edge.

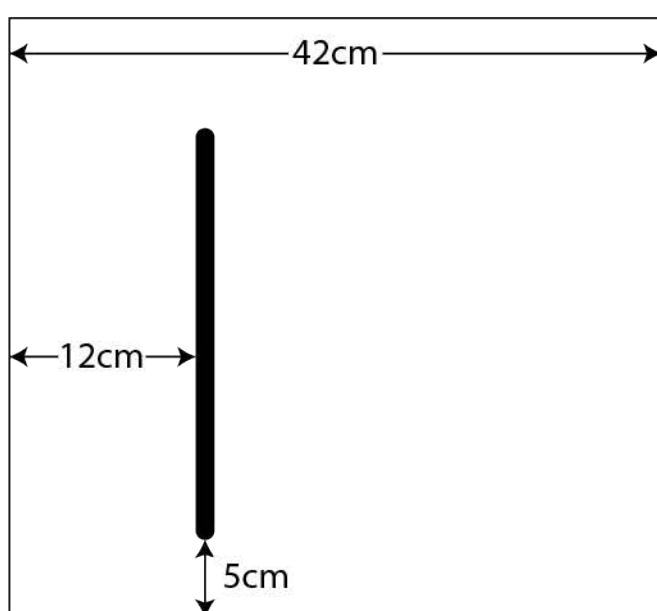

2.2 Sew the zipper

- Glue the grey area of the zipper (just a little bit at the edges). It would be easier for you to fix the position and sew the zipper.

- Pierce holes by a 4mm diamond chisel around the edge. 3mm in from edge. Stitch using waxed thread.



- Burnish the edge of Pattern #6.

- Punch 3mm holes and install 9mm double cap rivets on the zipper head.

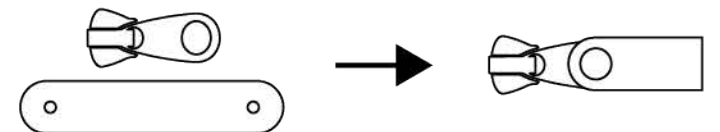

3.1 Add the strap holders at the back panel

- Sew the holders at the center of the back panel (Pierce holes by a 4mm diamond chisel, 3mm in from edge).
- Punch holes and add 9mm single cap rivets on the strap holders.

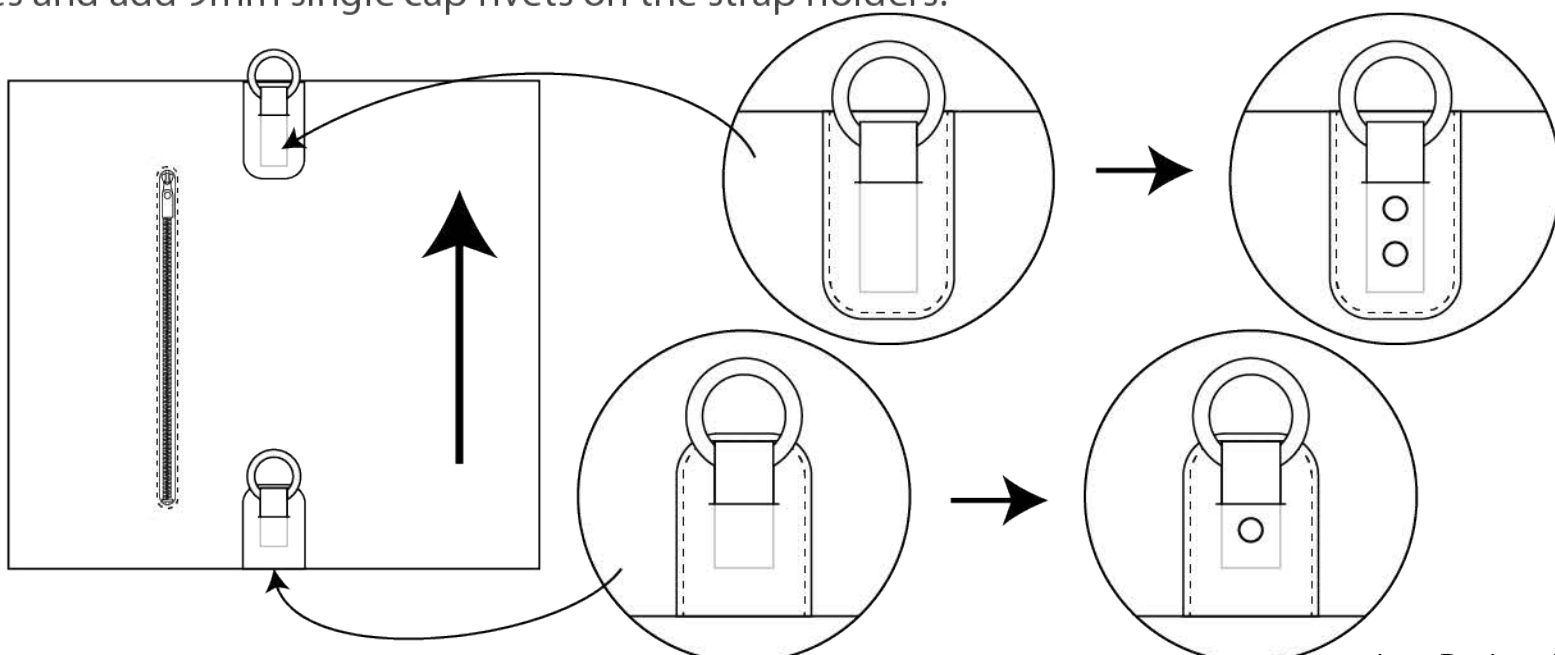

4.1 Add the pocket at the front panel

- Burnish the edges of pocket (Pattern #2) and badge (Pattern #17).
- Stamp your own logo on the badge before sewing it to the pocket piece (Pattern #2).
- Glue the bottom and two sides of the pocket and place it on top of the front panel, according to the position indicated in the illustration.
- Pierce holes by a 4mm diamond chisel. 2mm and 6mm in from edge. Stitch using waxed thread.
- Punch holes and add two 6mm double cap rivets at the corners of the pocket.

Pierce holes by a 4mm diamond chisel. 2mm and 6mm in from edge. Stitch using waxed thread.

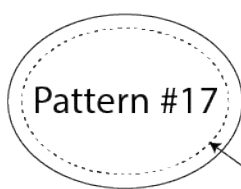

Stitching line
2mm in from
edge

Pattern #2
Pocket x 1

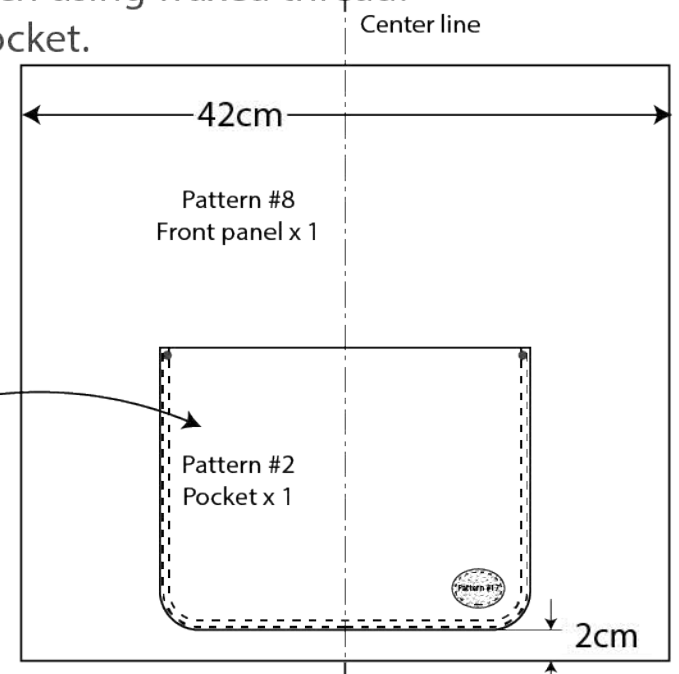

5.1 Sew the top and bottom pieces on the main panels

- Glue "Pattern #3 Body top" and "Pattern #4 Body bottom" on top of the front panel. Overlap 6mm.

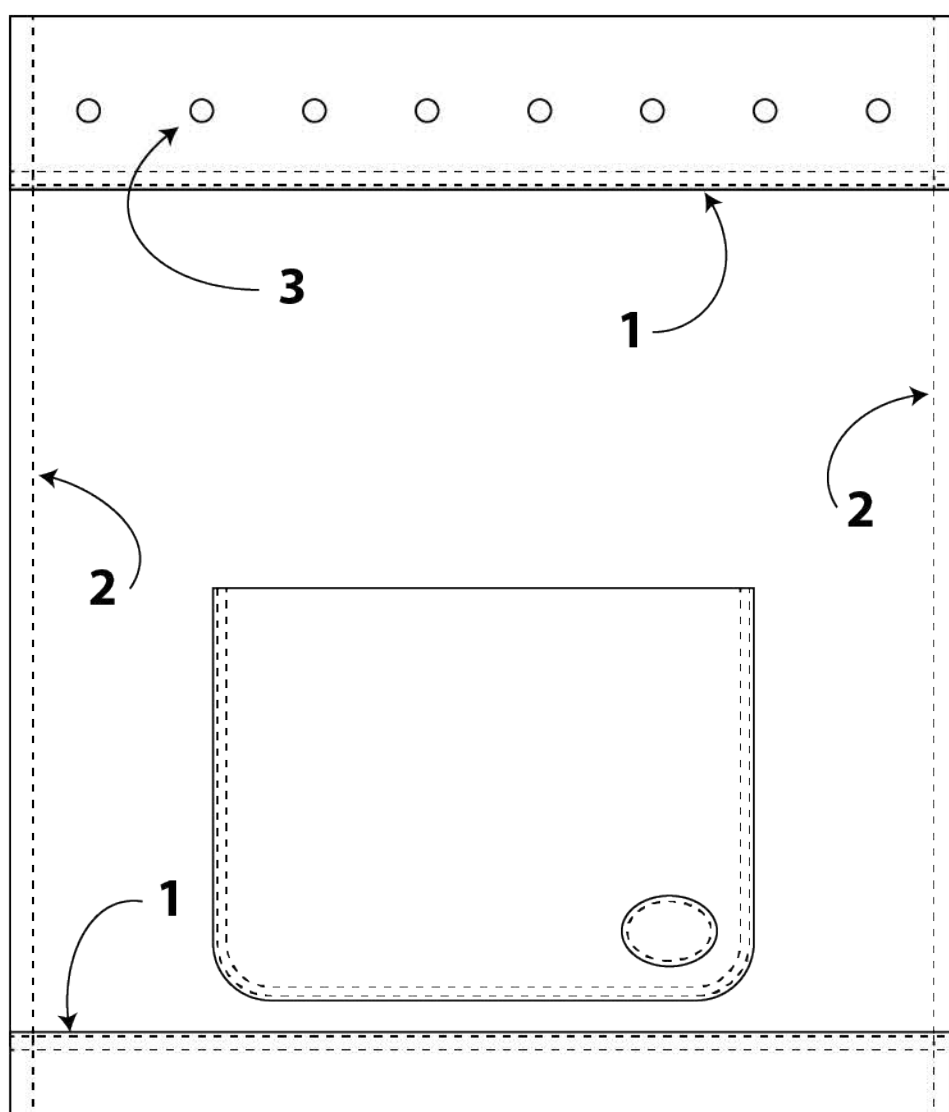
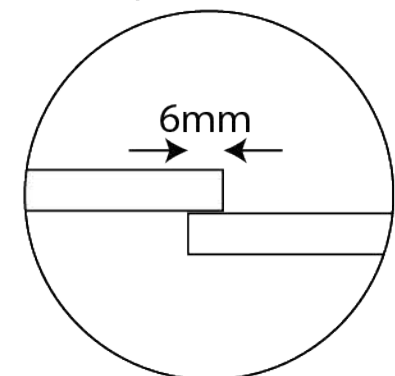
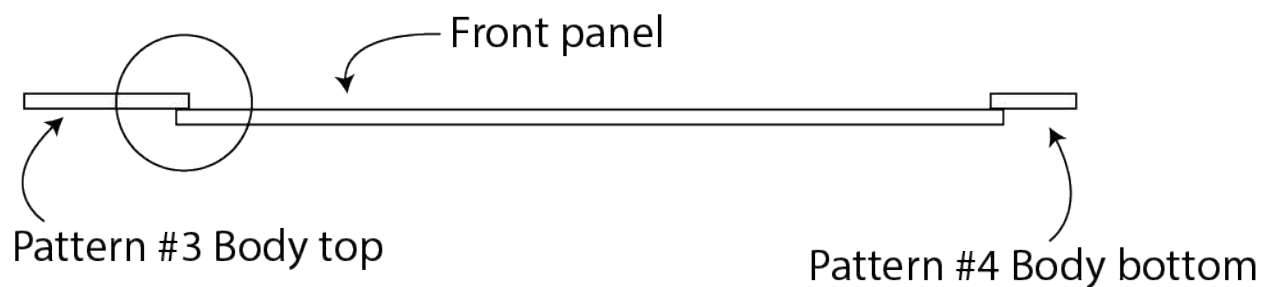

- 1) Pierce holes by a 4mm diamond chisel. 3mm and 9mm in from edge. Stitch using waxed thread.

----- 9mm in from edge (Decal line only)

----- 3mm in from edge
Edge of top/bottom pattern

- 2) Pierce holes by a 4mm diamond chisel. 1cm in from edge.

3. Use a 8mm hole puncher and eyelet punch tool to install 8 eyelets on the body top piece.

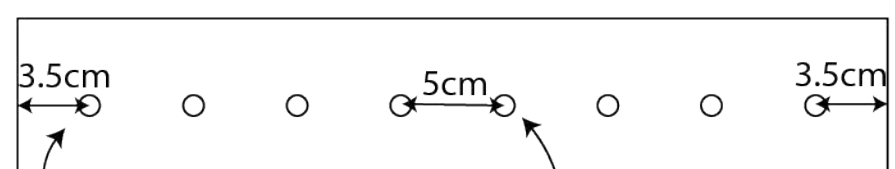

3.5cm from the edge to the center of the hole

5cm from the center of the hole to the other

- Do the same for the back panel.

5.2 Sew the top and bottom pieces on the main panels

- Now, you should have two completed front and back panels now.

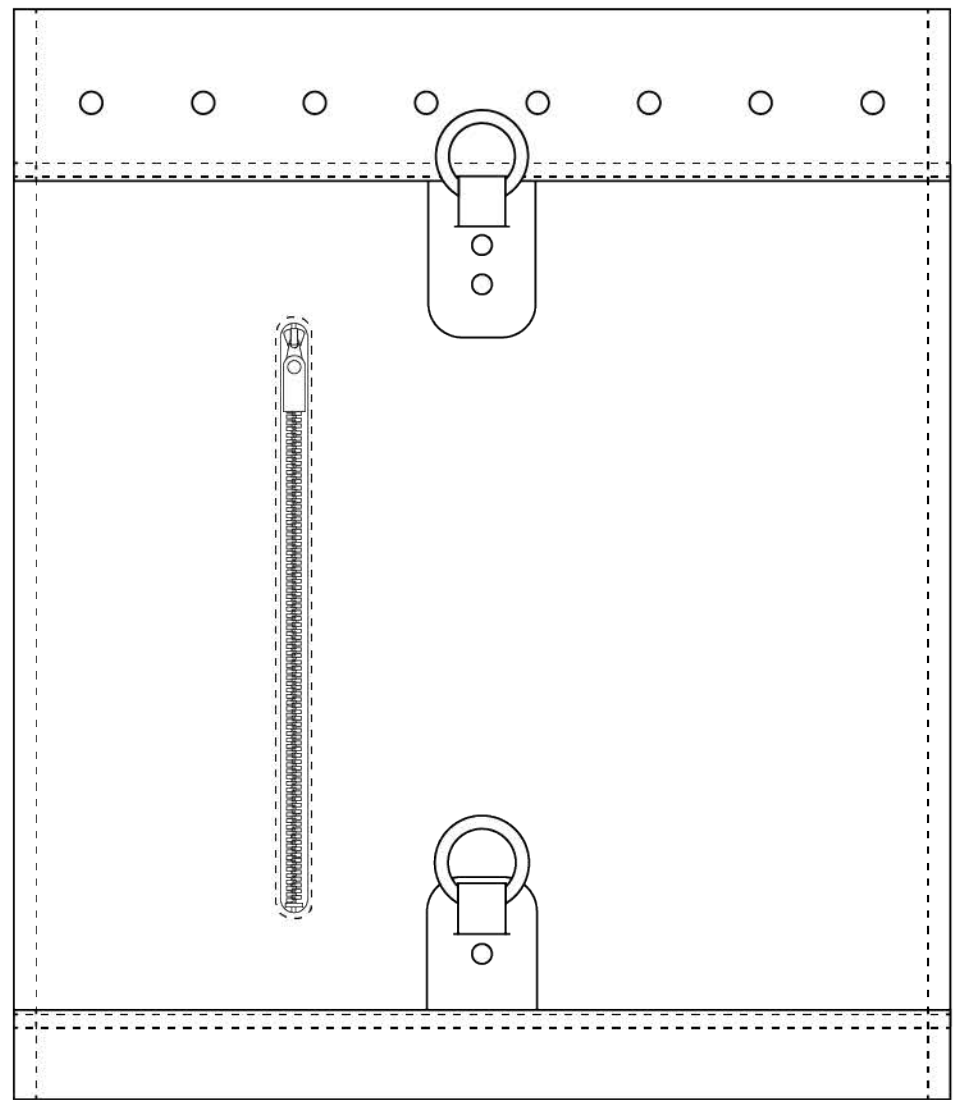
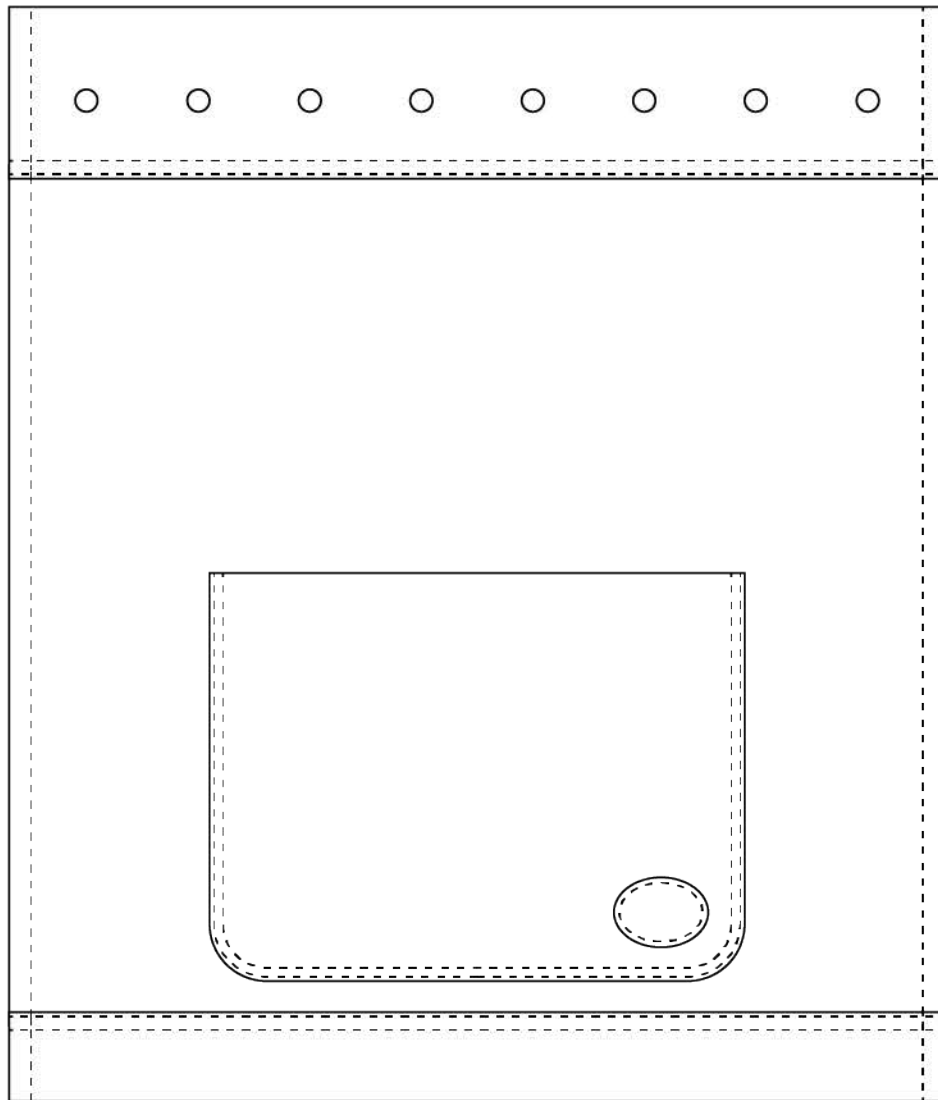

6.1 Assemble the body

- Assemble the body using turned edge seams: Place the front and back panels together with the flesh sides facing out. Stitch the two sides using waxed thread.
- Decorate the sides seams using Double Top-Stitched Seam.

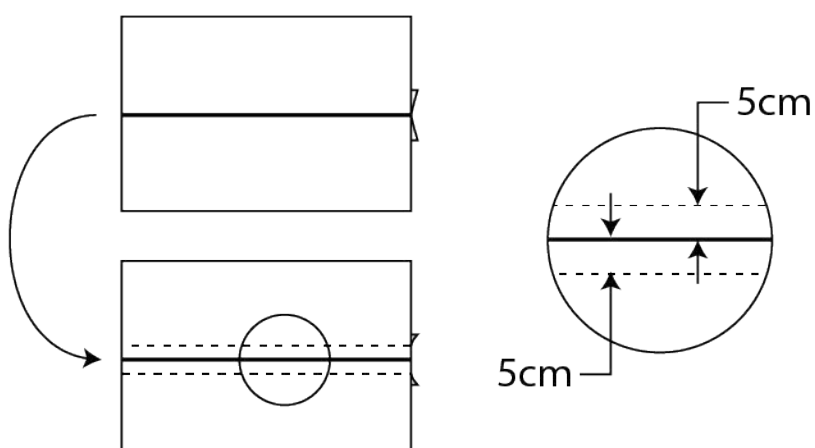
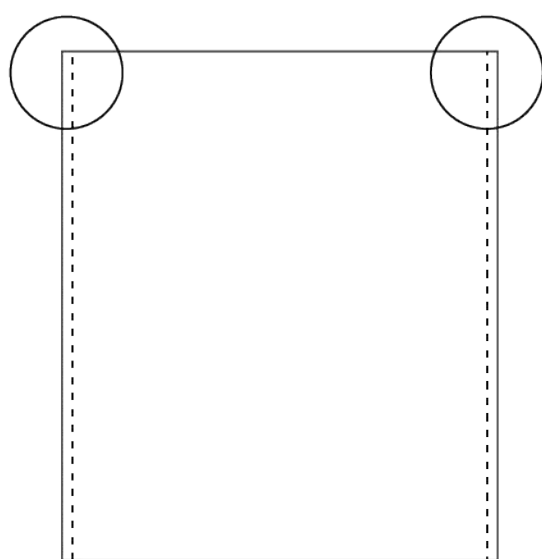

6.2 Assemble the body

- Pierce holes along the bottom of the main panels and the bottom piece (Pattern #1) by a 4mm diamond chisel. 5mm in from edge.

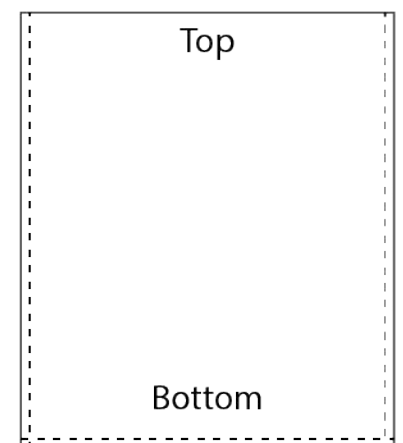

6.3 Assemble the body

- Stitch the main panels and the bottom piece together with the flesh sides facing out.
- Flip the assembled body inside out so the stitches are hidden.
- Now, you should have something like this.

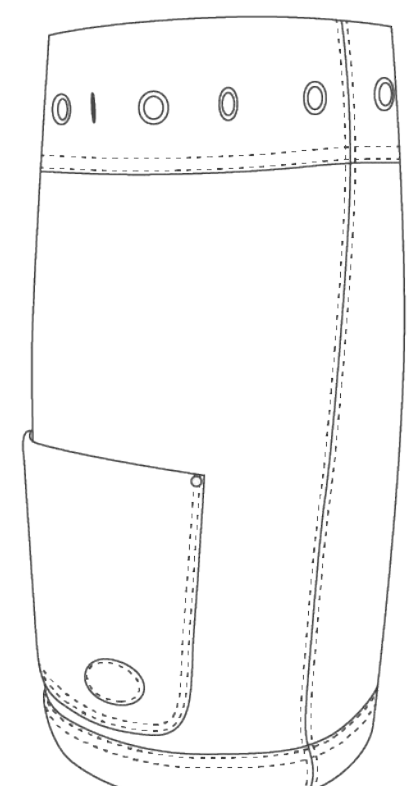

6.4 Assemble the body

- Hem the opening edge (fold 1cm over).



- Pierce holes by a 4mm diamond chisel. 5mm in from edge.

- Stitch using waxed thread.

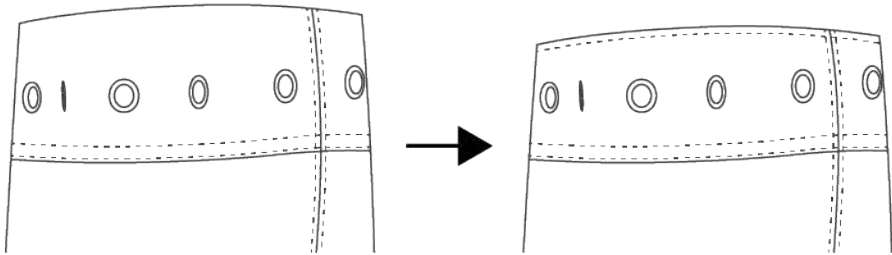

7.1 Drawstring

- Cut a 110 x 2cm leather piece for the drawstring (Pattern #5).
- Glue along the flesh side. Fold it into half.
- Pierce holes by a 4mm diamond chisel along the center line.
- Stitch using waxed thread.
- Burnish the edges.

7.2 Drawstring

- Make a drawstring stopper (Pattern #18).
- Burnish the edges.
- Fold it into half.
- Add three 6mm double cap rivets.

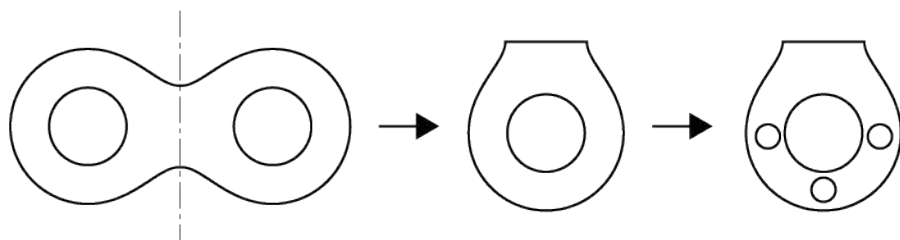

7.3 Drawstring

- Add the drawstring and the stopper to the bag.
- Make a simple knot on both ends.

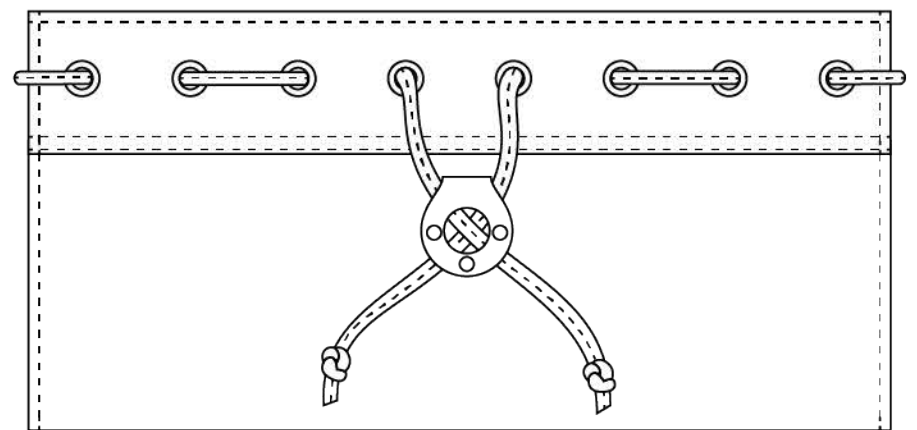

8.1 Shoulder strap

- You need the following for the shoulder strap: Pattern #9, #10, #11, #12, #13

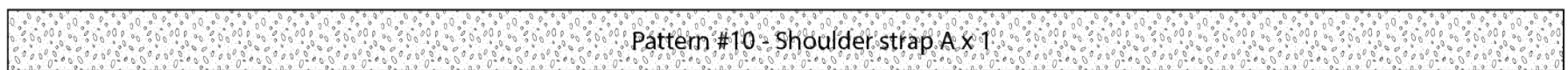

- Glue and fold according to this sequence:

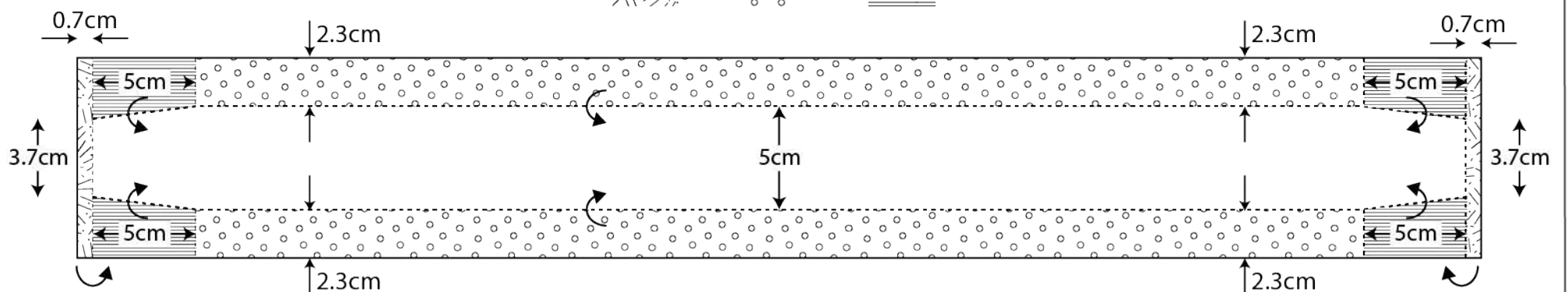

- Now, you should have something like this (a shoulder pad):

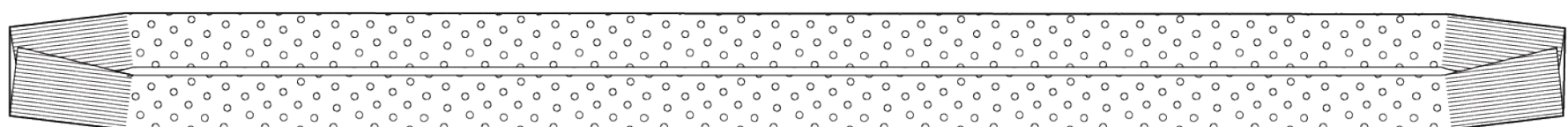

8.2 Shoulder strap

- Burnish the edges of Pattern #10. Glue the flesh side, and use it to cover the raw area of the shoulder pad.
- Pierce holes by a 4mm diamond chisel on the long sides of Pattern #10. 3mm in from edge.
- Stitch through the shoulder pad and Pattern #10 using waxed thread.

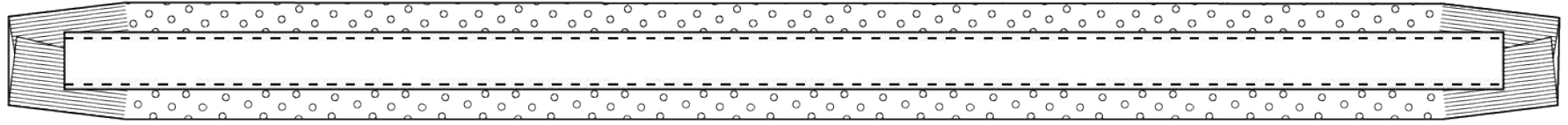

8.3 Shoulder strap - Pin buckle x 2

- Burnish the edges of Pattern #13.
- Cut a 3mm x 16mm slot for the pin buckle.
- Add a pin buckle and rectangle ring.
- Glue the indicated area. Fold it into half.

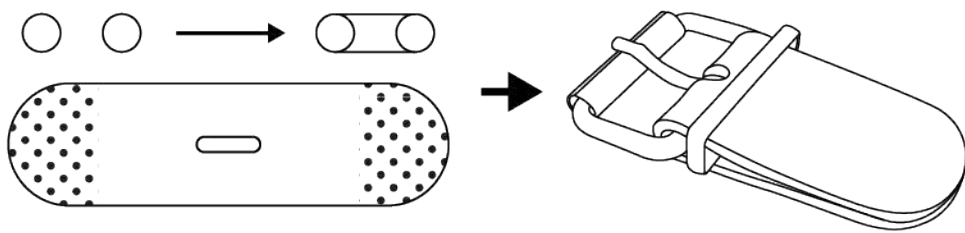

8.4 Shoulder strap

- Burnish the edges of Pattern #11 and #12.
- Punch 7 holes on Pattern #11 and 4 holes on Pattern #12.

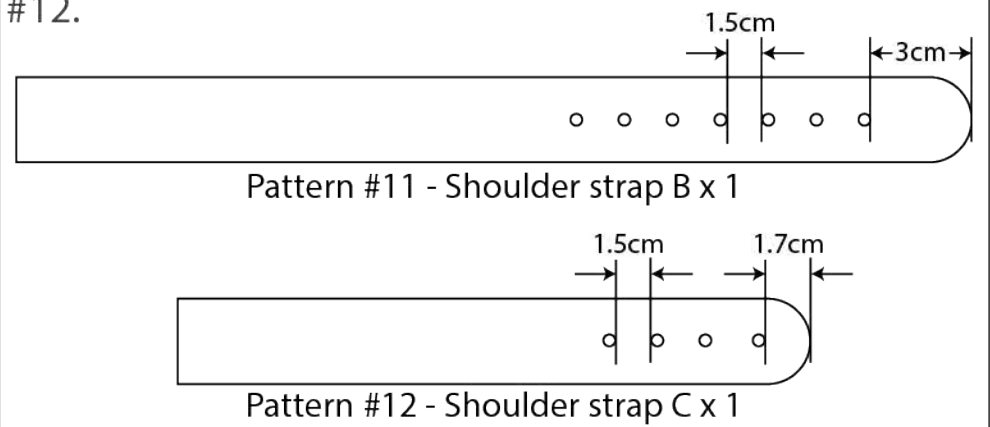

8.5 Shoulder strap

- Punch a 3mm hole on:

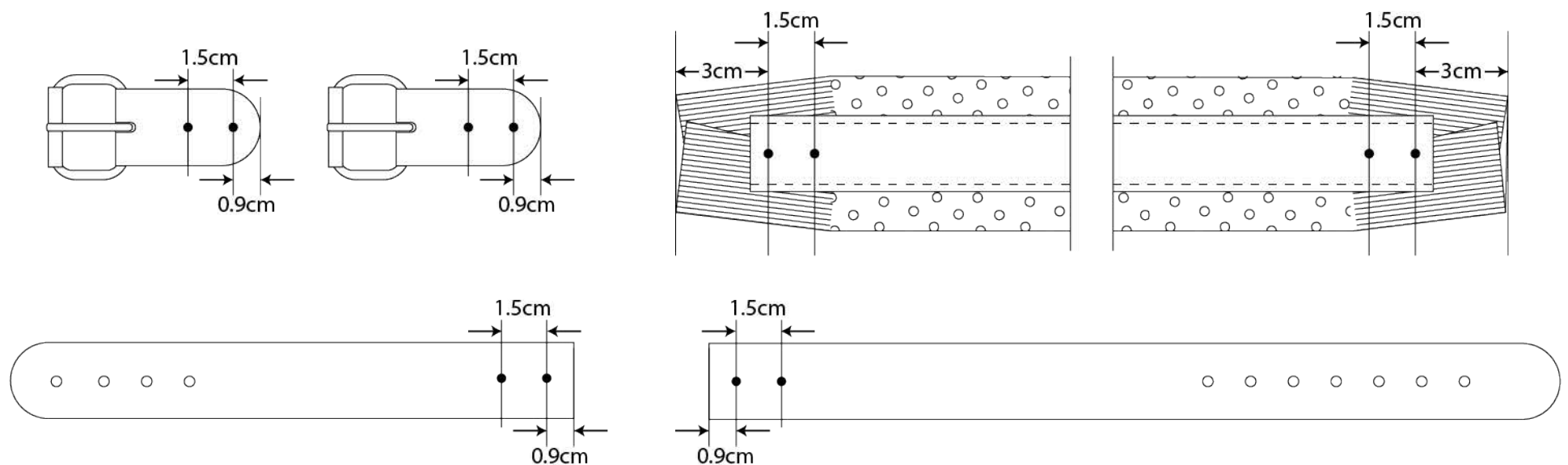

8.6 Shoulder strap

- Add four 9mm double cap rivets (Punch through the pin buckle holder, the shoulder pad, and the strap):

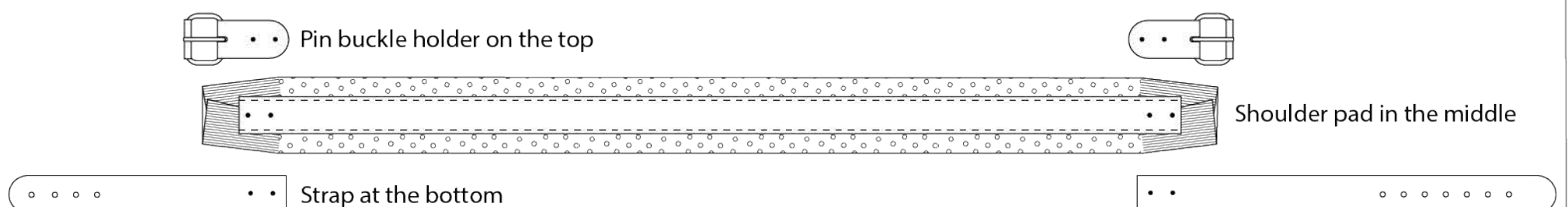

- Now, the shoulder strap is almost completed.

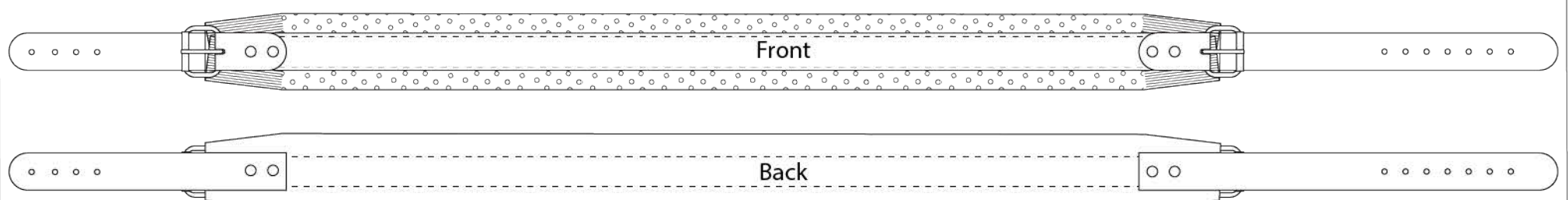

9.1 Last step - Fasten the pin buckle and adjust the strap length

- Put the strap through the O ring, adjust the length, and fasten the pin buckle.
- Your bag is ready to use now!

