

Leather needed for a Dragon:

about 0,60 m2

600 mm (24 in)

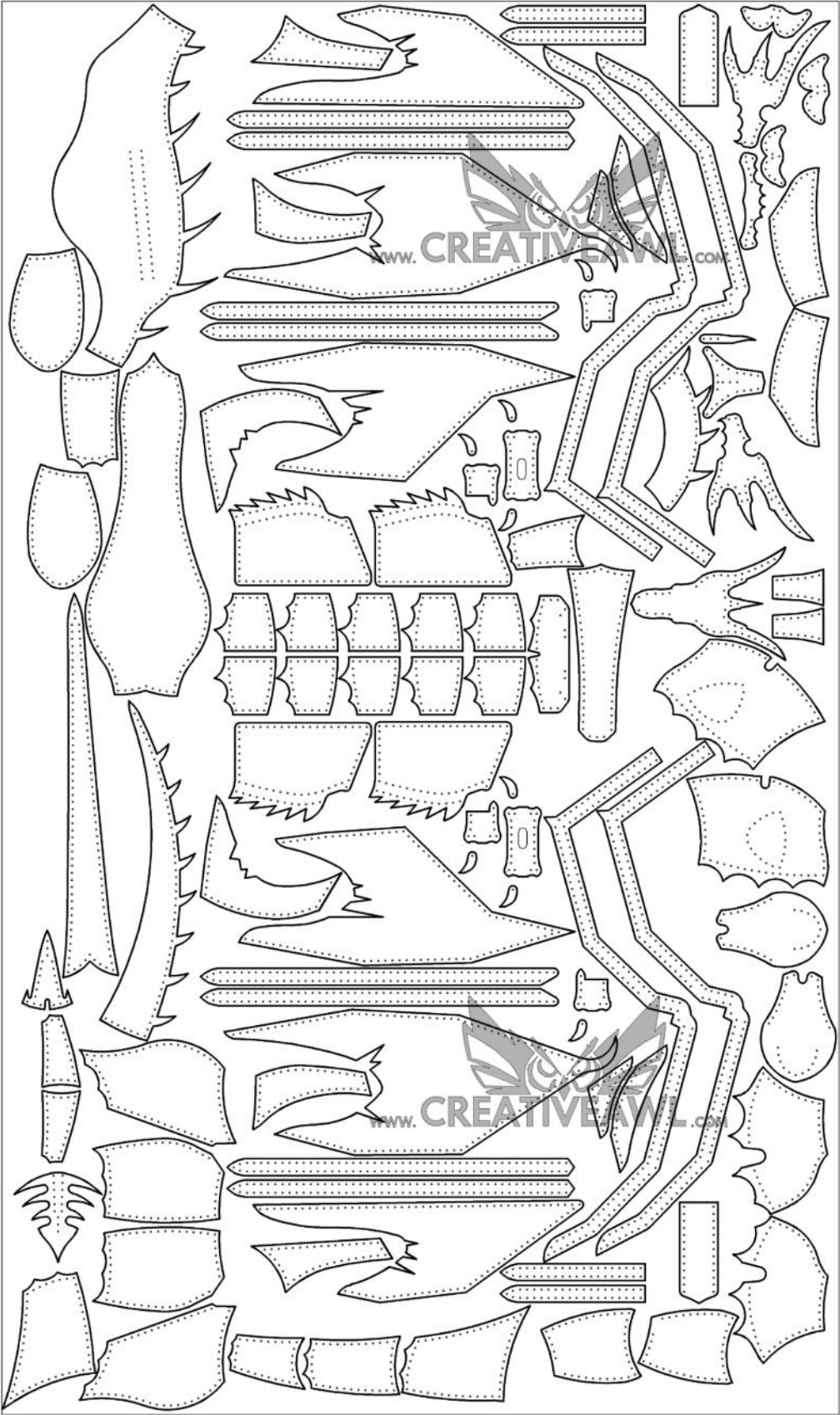

1000 mm (40 in)

Sketch drawing
Bill of materials

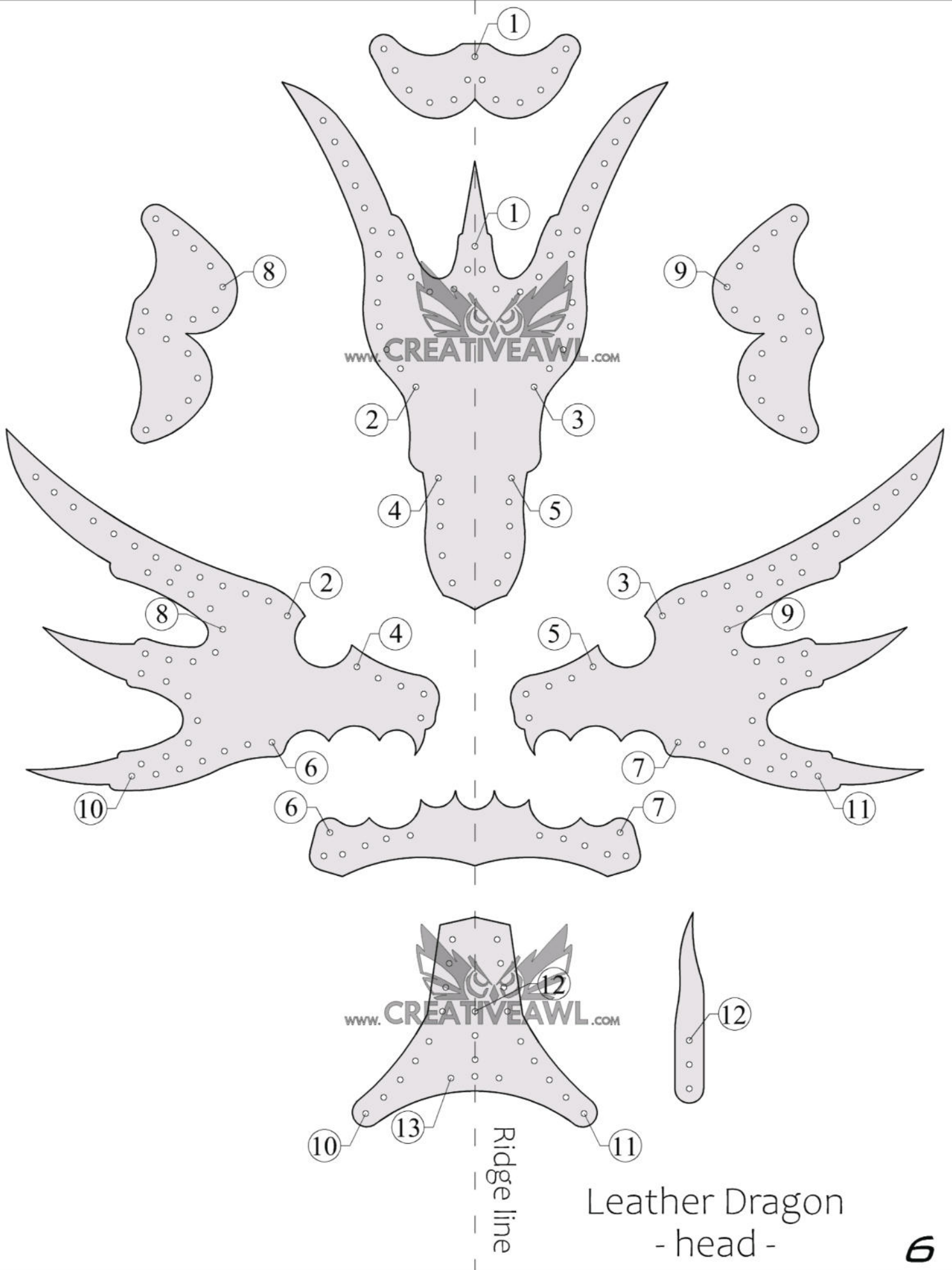

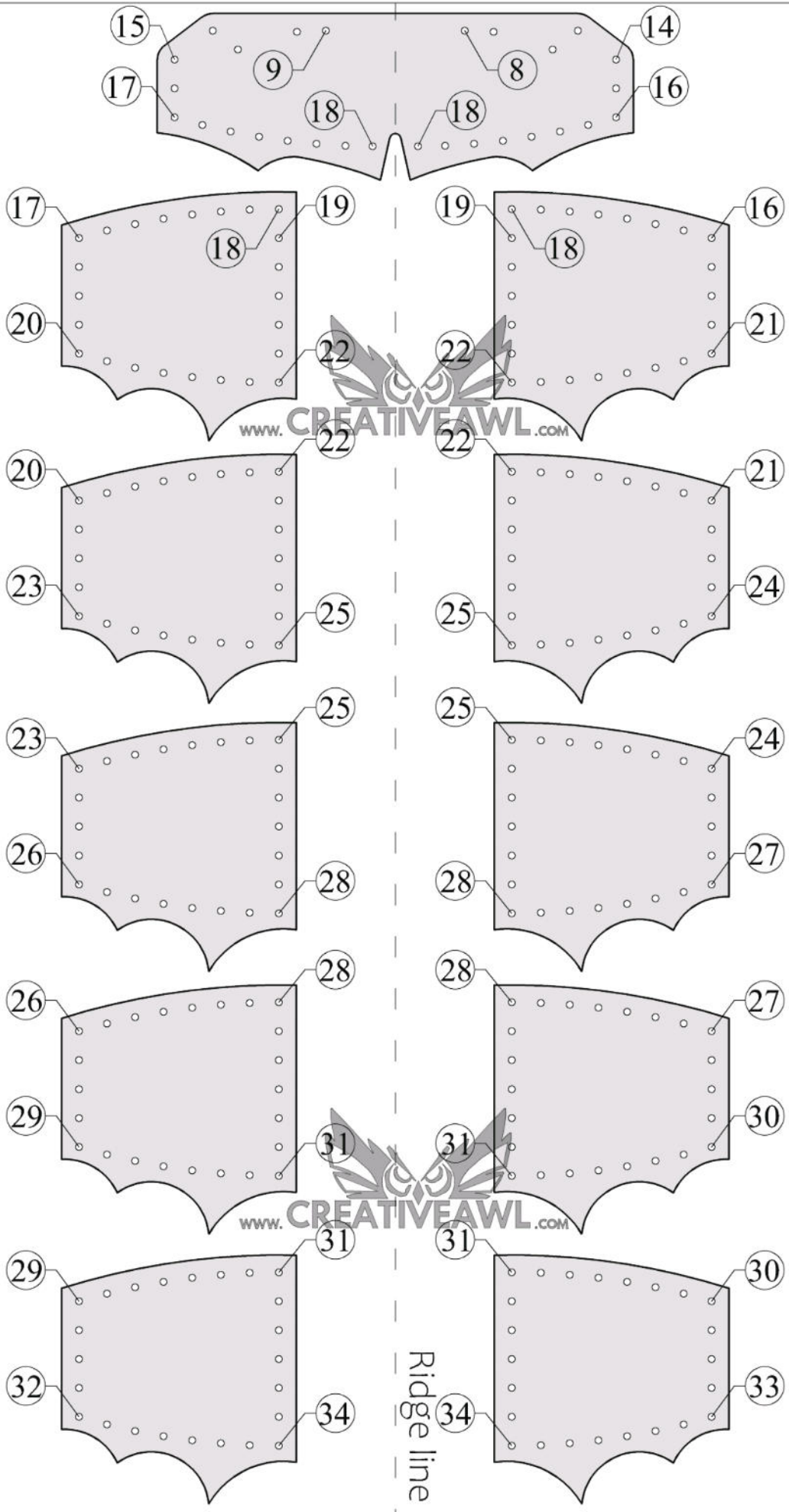

Leather Dragon
- dragon neck -

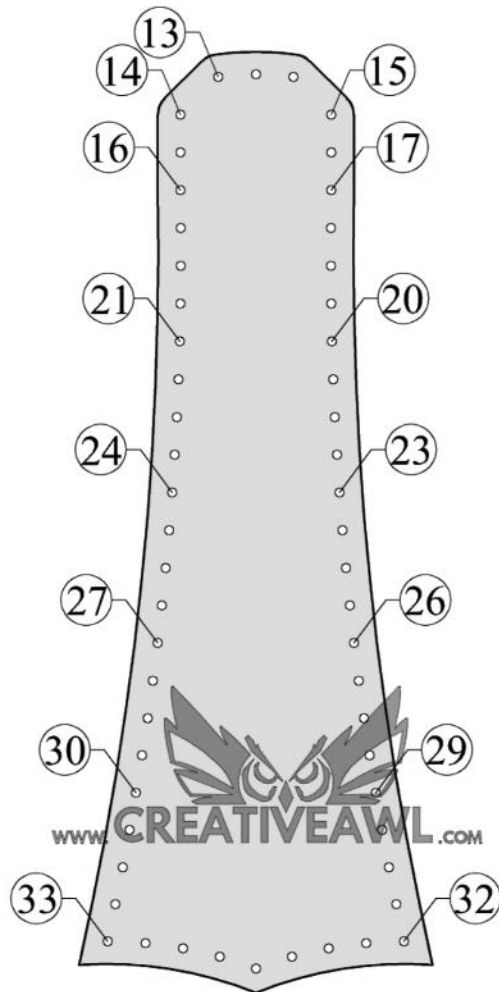
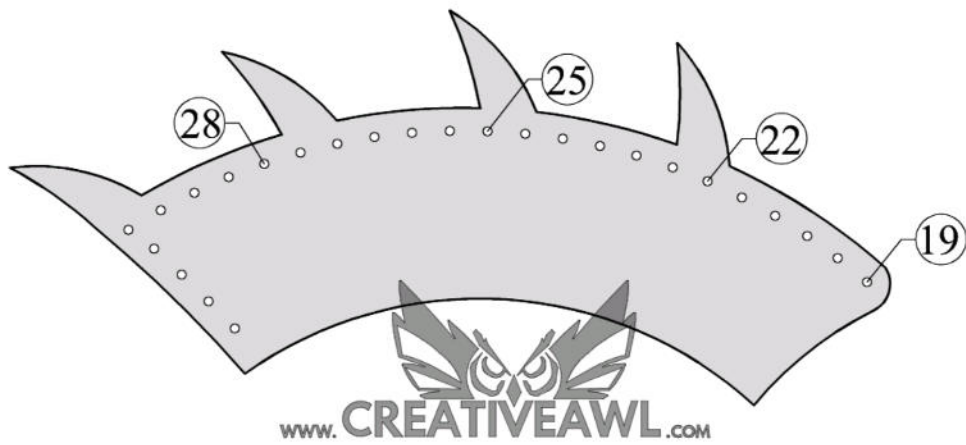

Leather Dragon
- neck components -

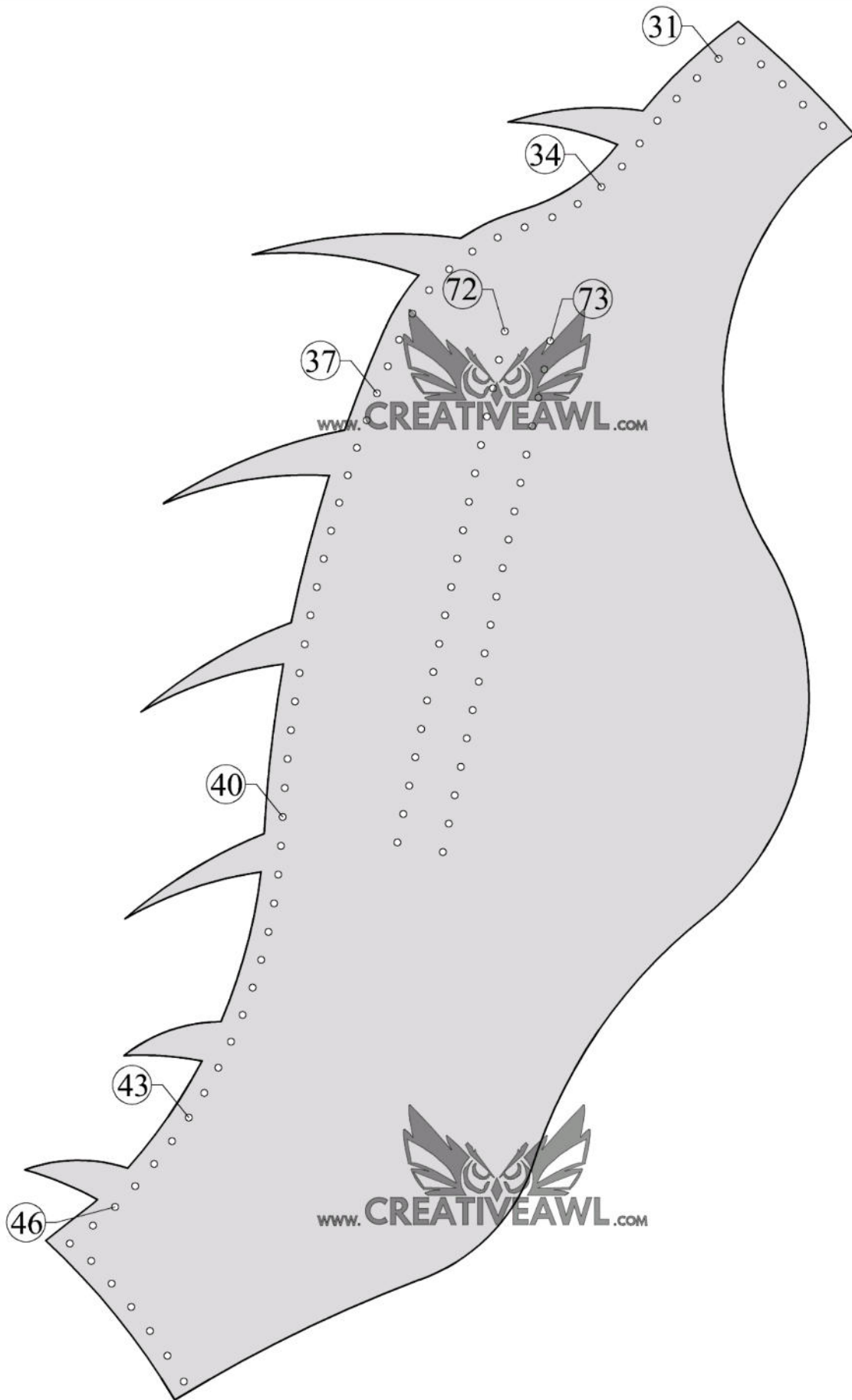

Leather Dragon
- torso component -

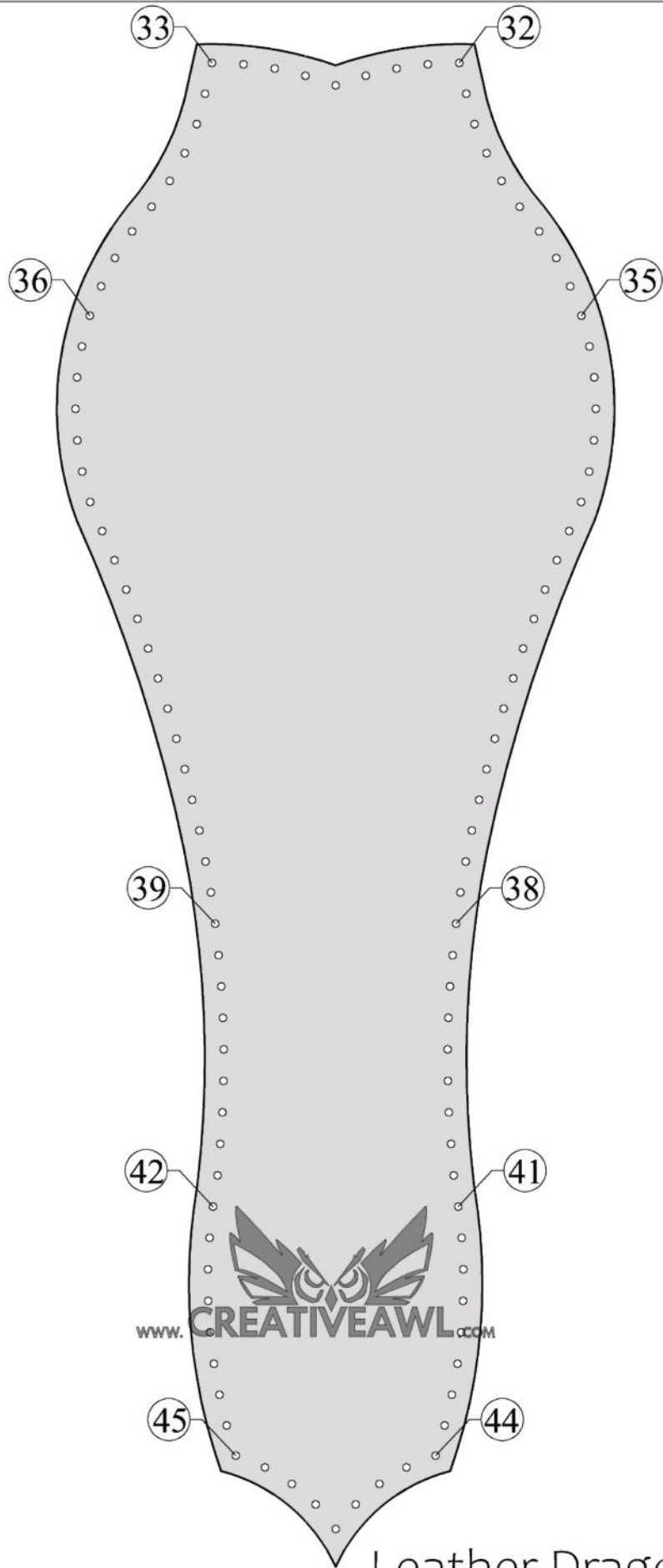

Leather Dragon
- abdominal component - 10

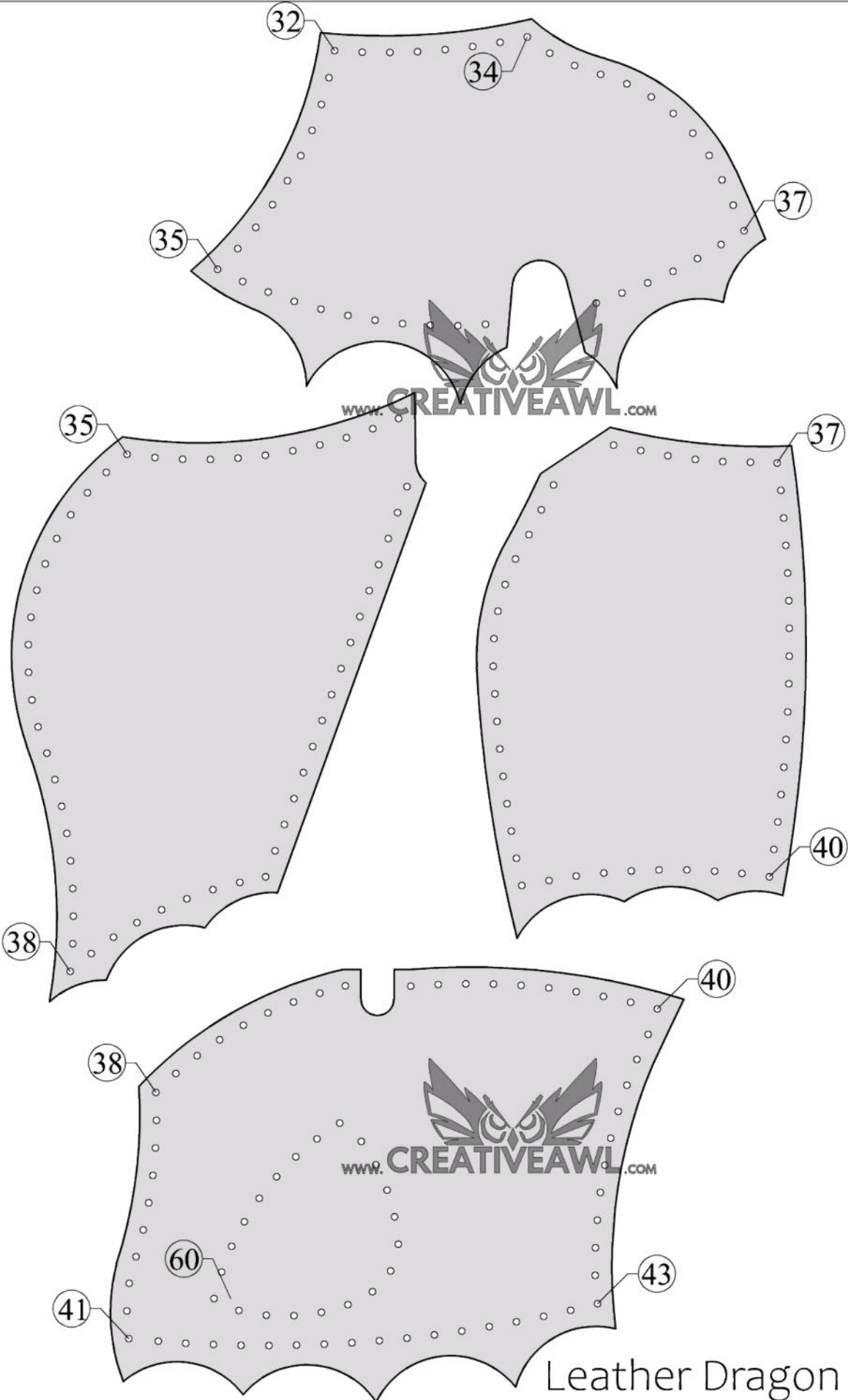

Leather Dragon
- left torso components -

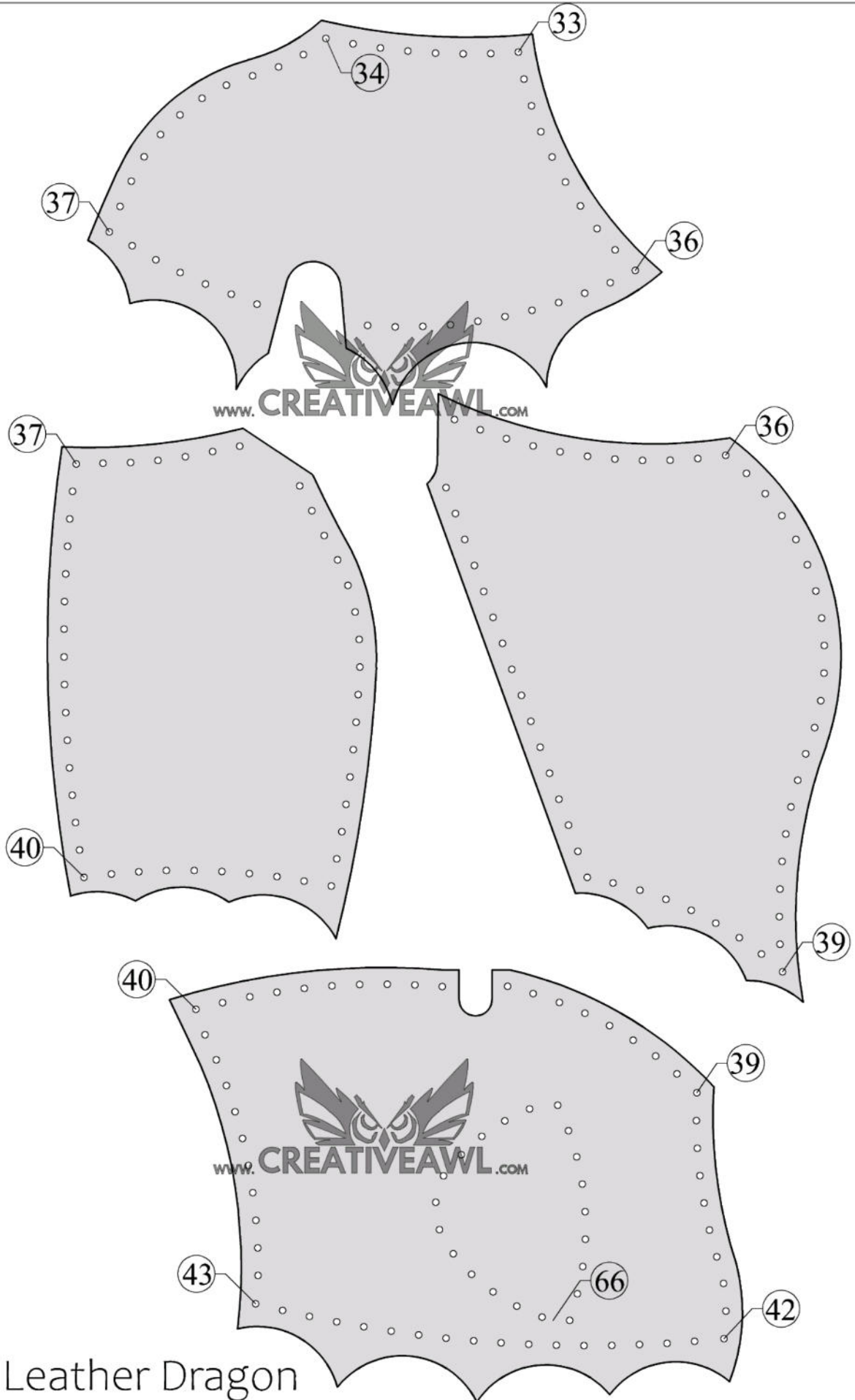

Ridge line

Leather Dragon

- right torso components -

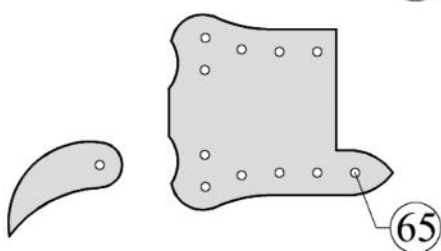
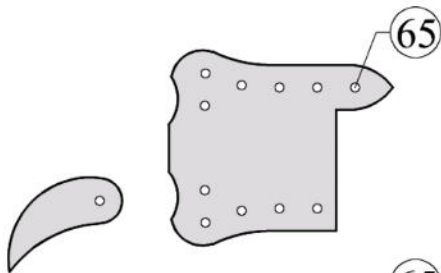
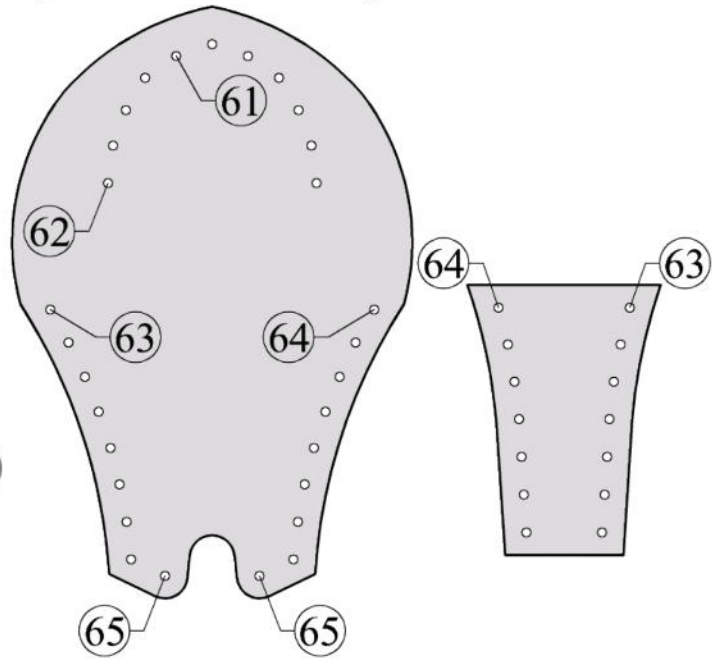
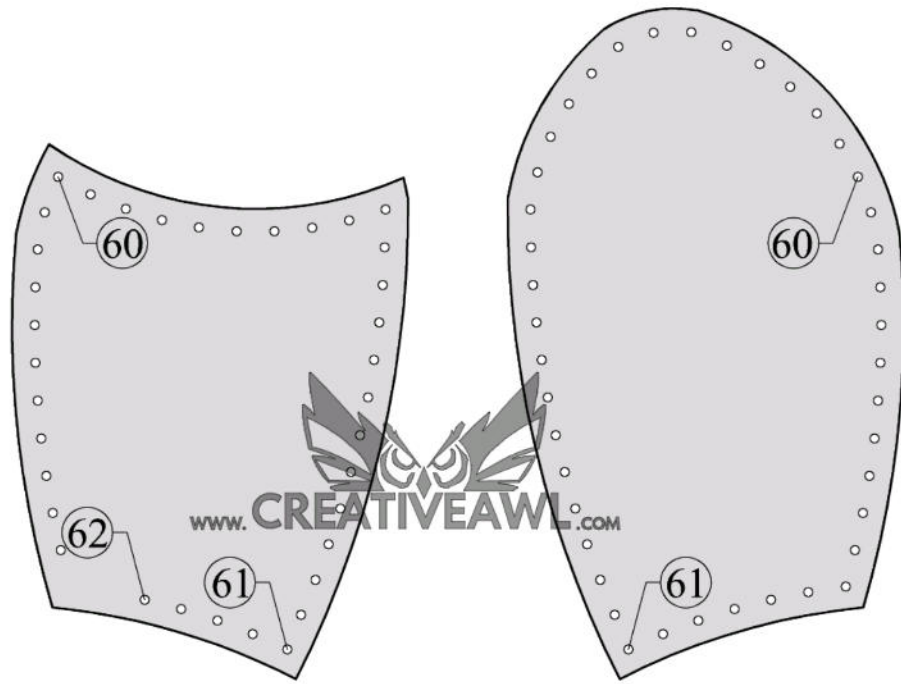

Leather Dragon
- left leg -

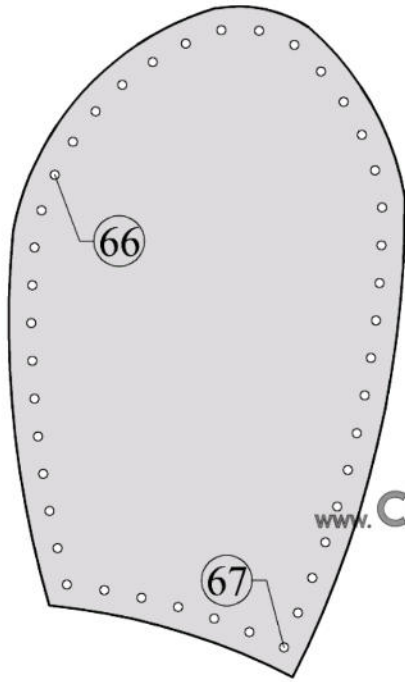

www.CREATIVEAWL.COM

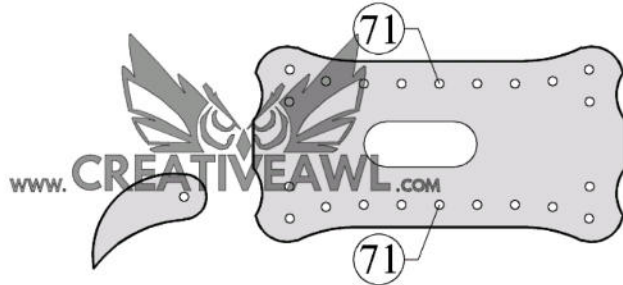
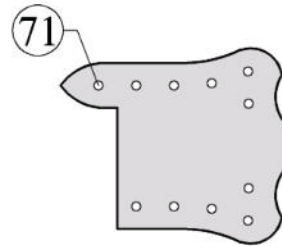
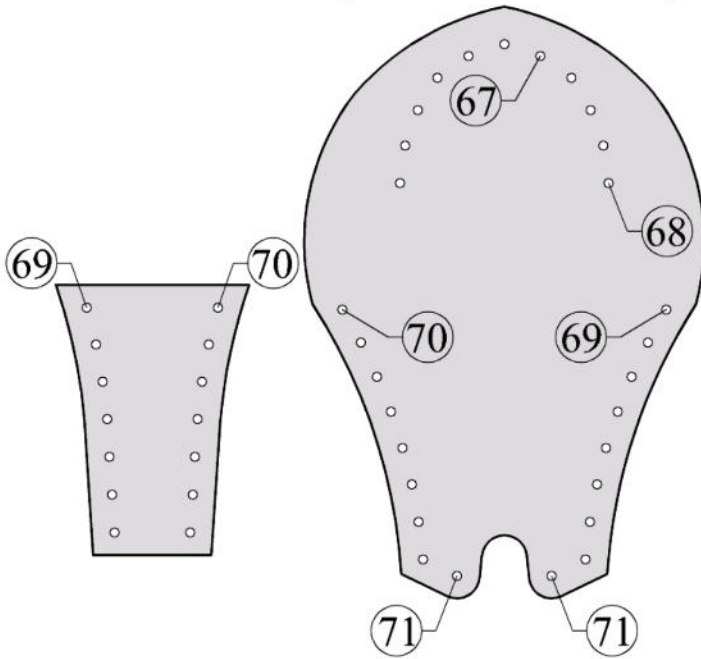

www.CREATIVEAWL.COM

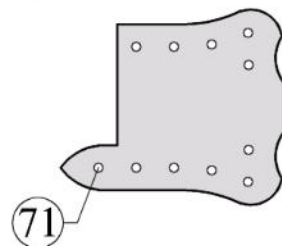
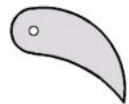

Leather Dragon
- right leg -

11 in
LETTER
8,5 in

A4

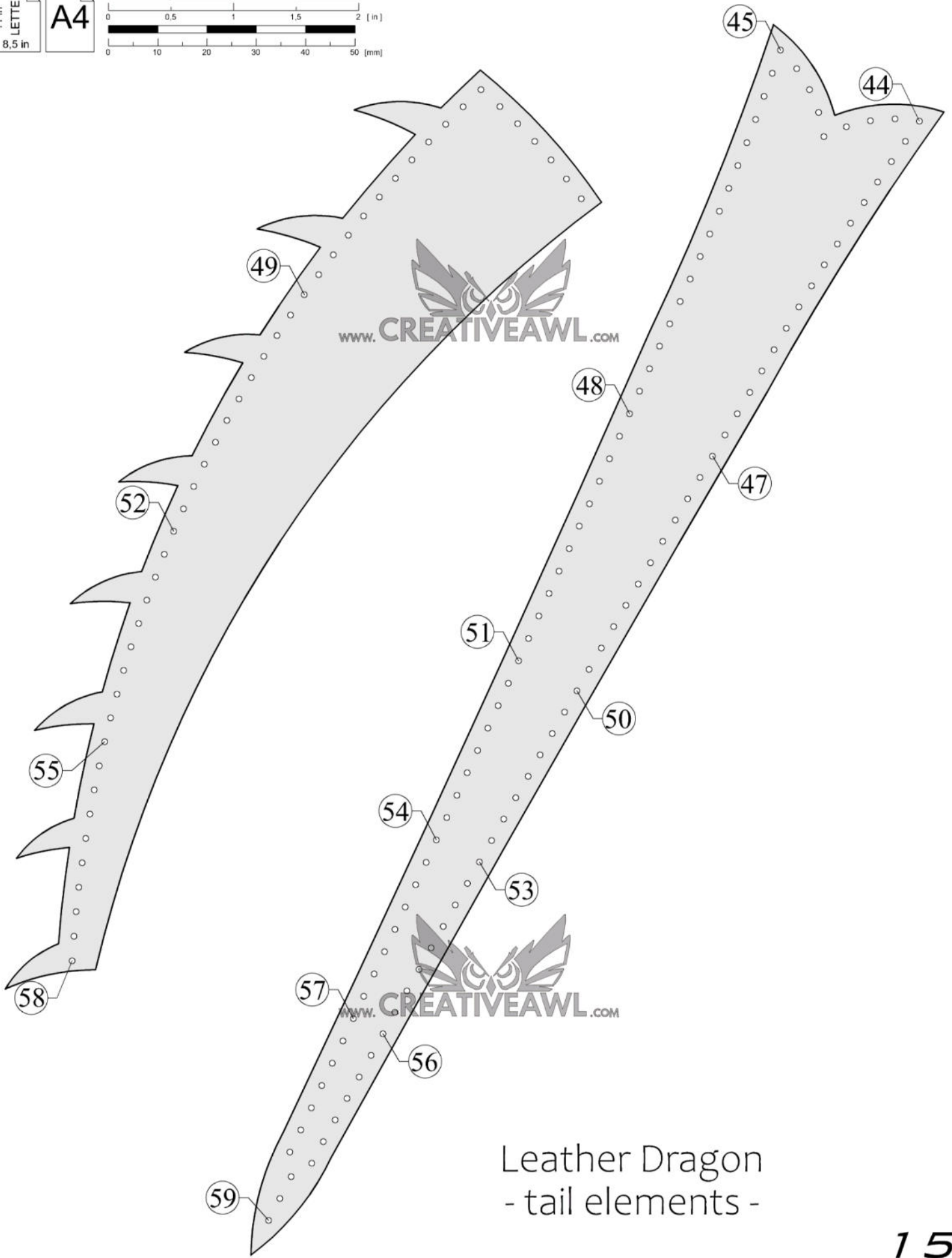
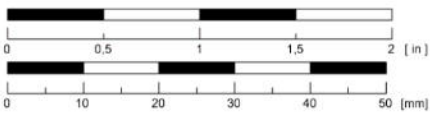

Leather Dragon
- tail elements -

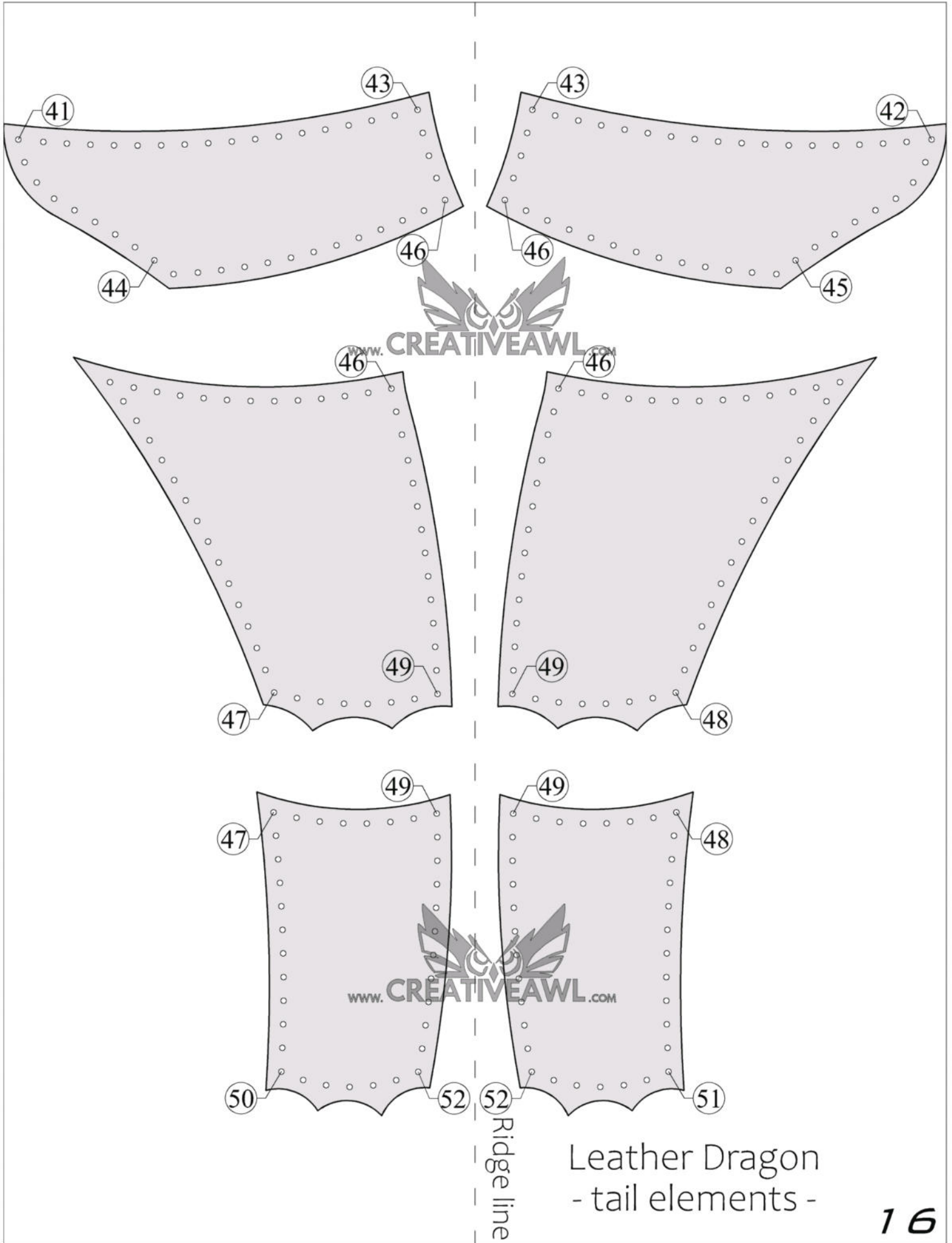

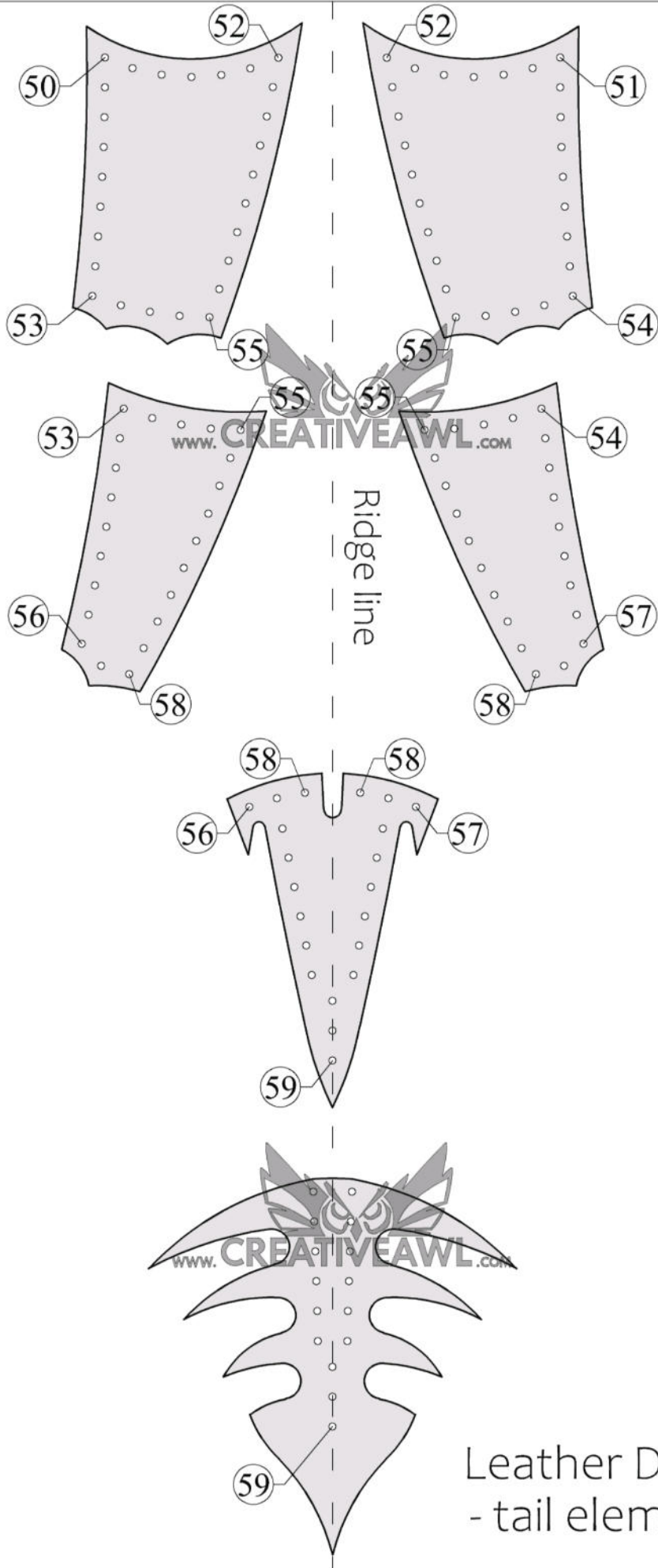

Leather Dragon
- tail elements -

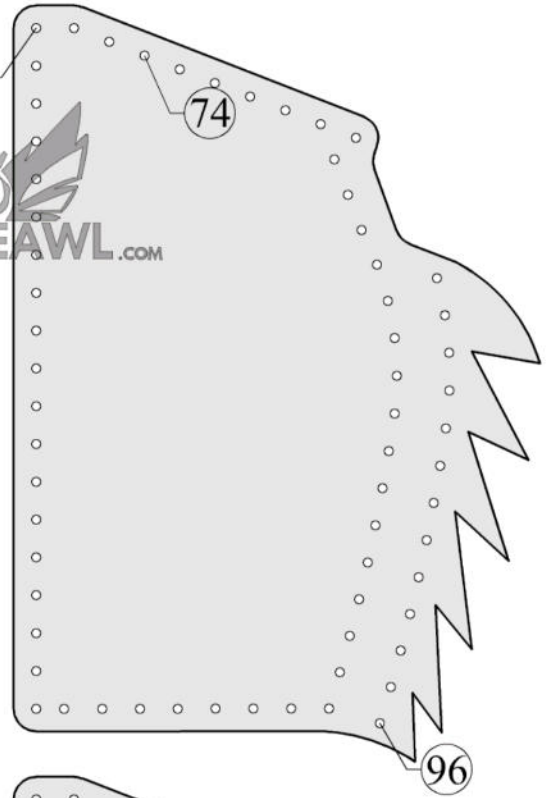
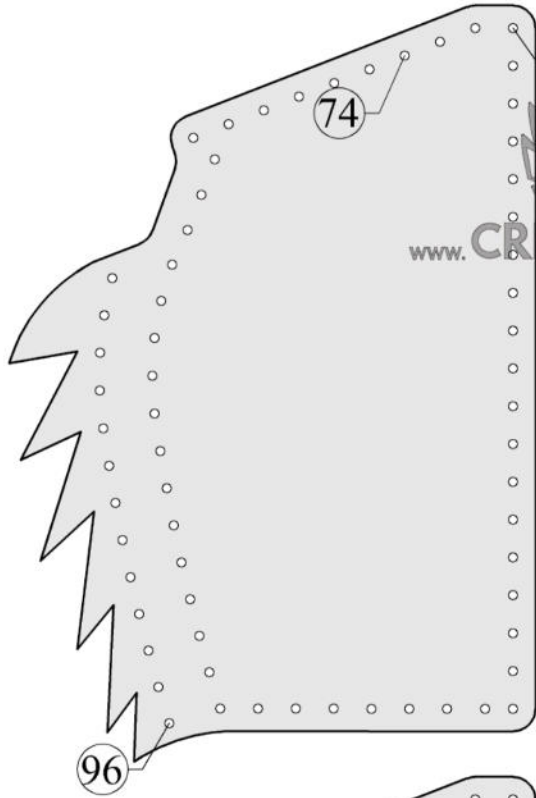
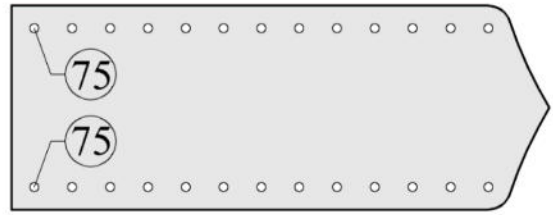
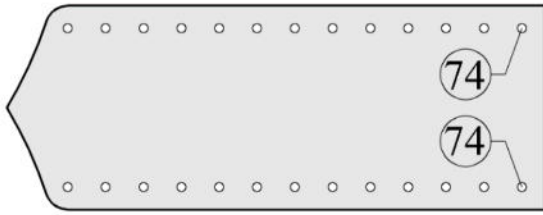

72 73

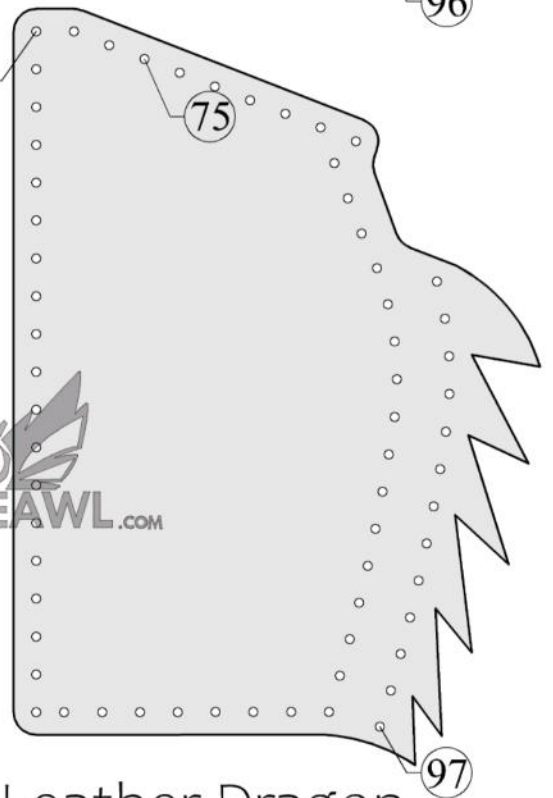
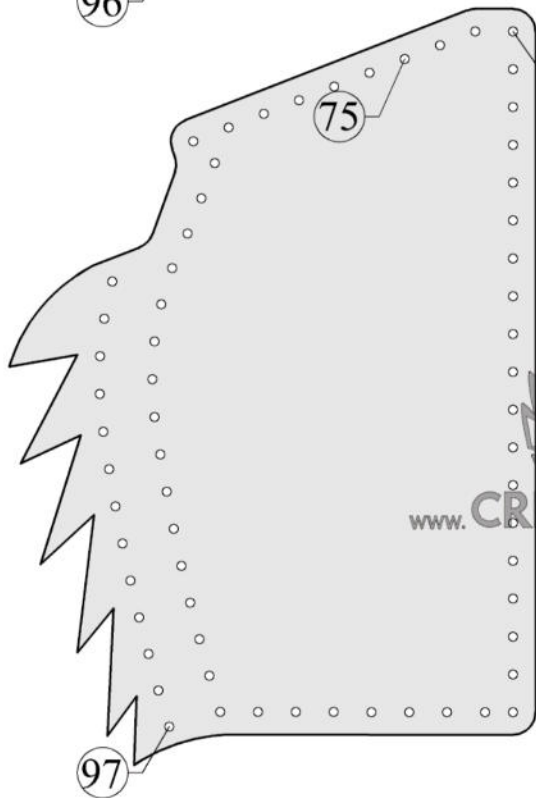

73 72



Leather Dragon
- trunk component -

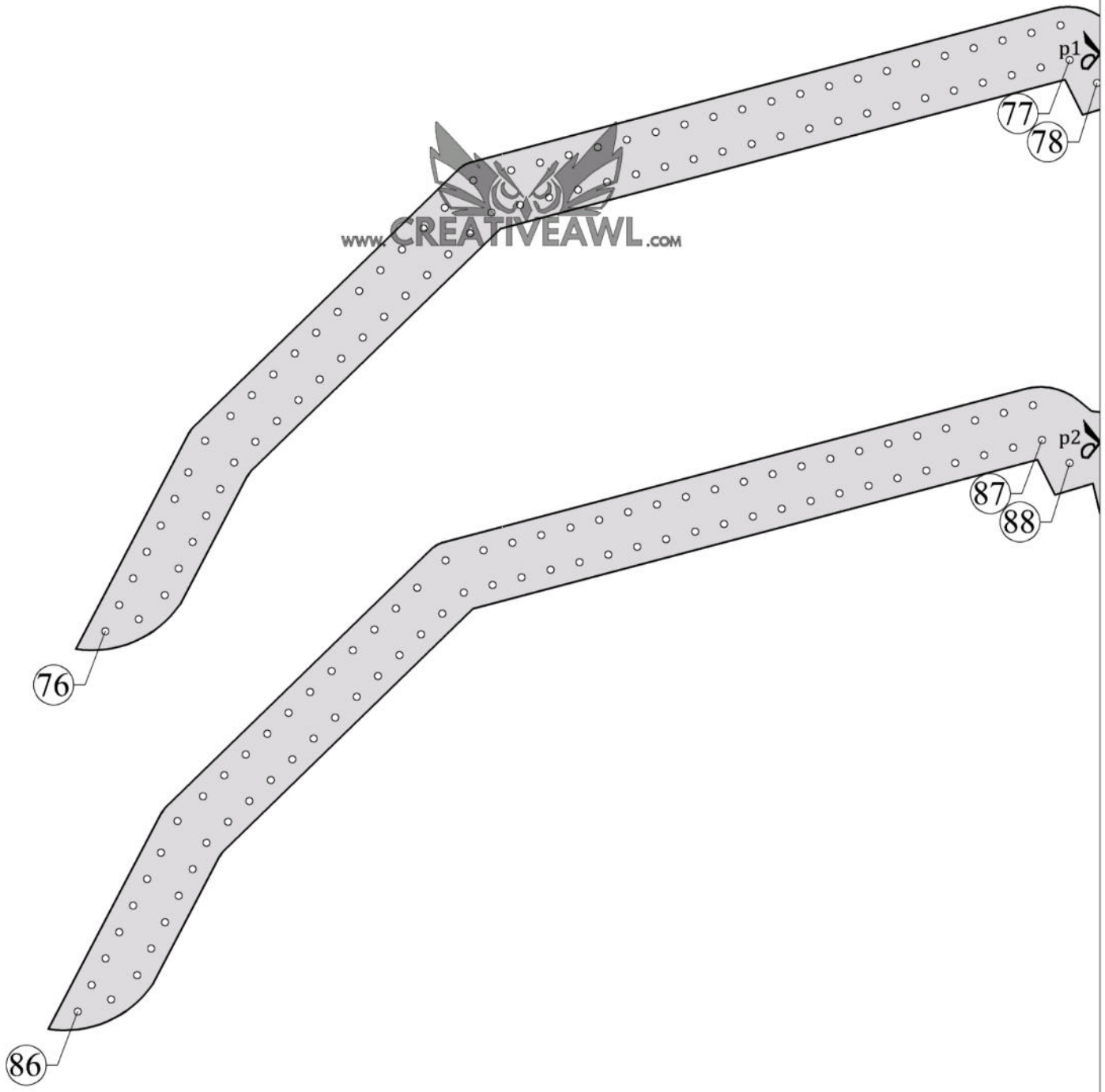

Leather Dragon
- right wing elements -

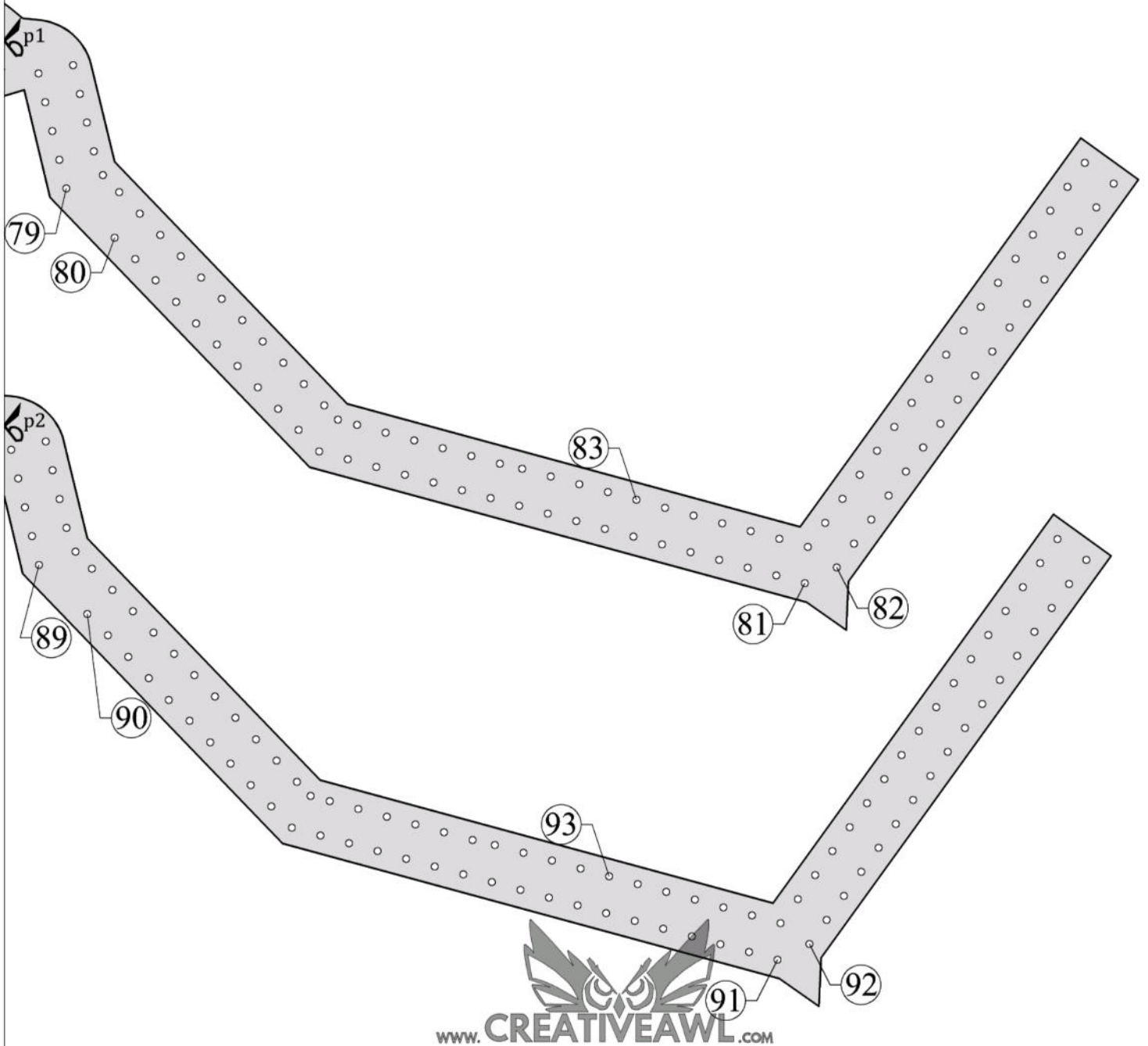

Leather Dragon
- right wing elements -

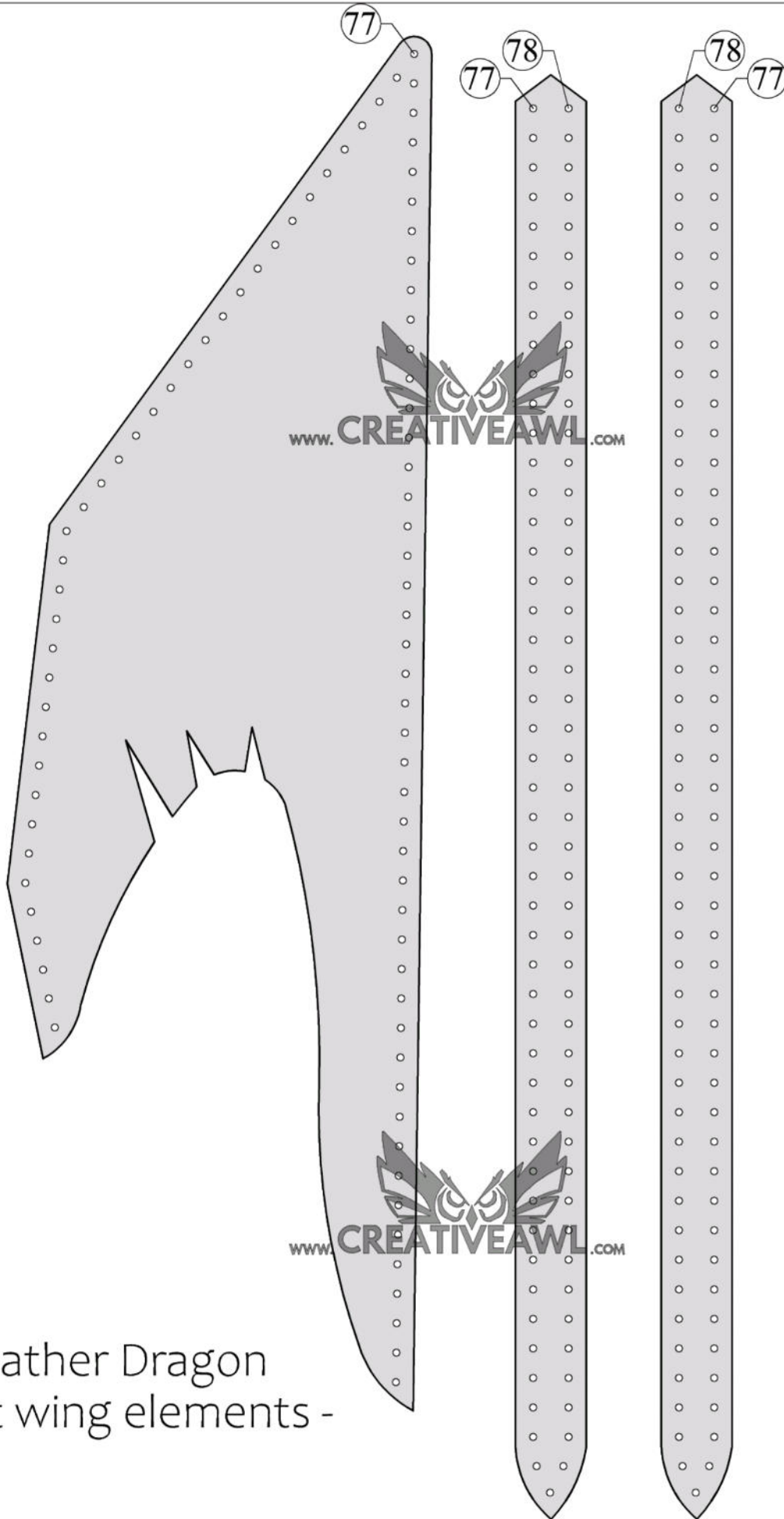

Leather Dragon
- right wing elements -

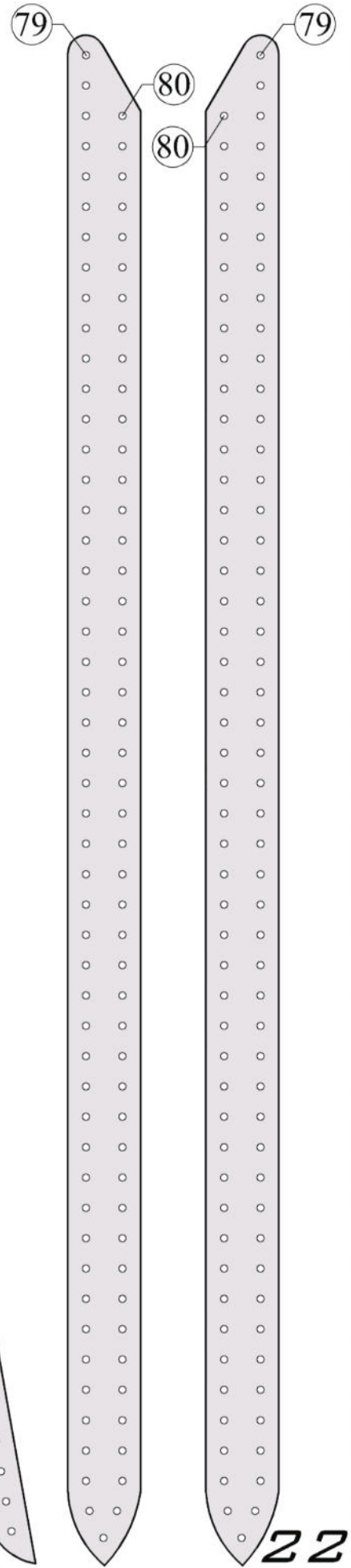
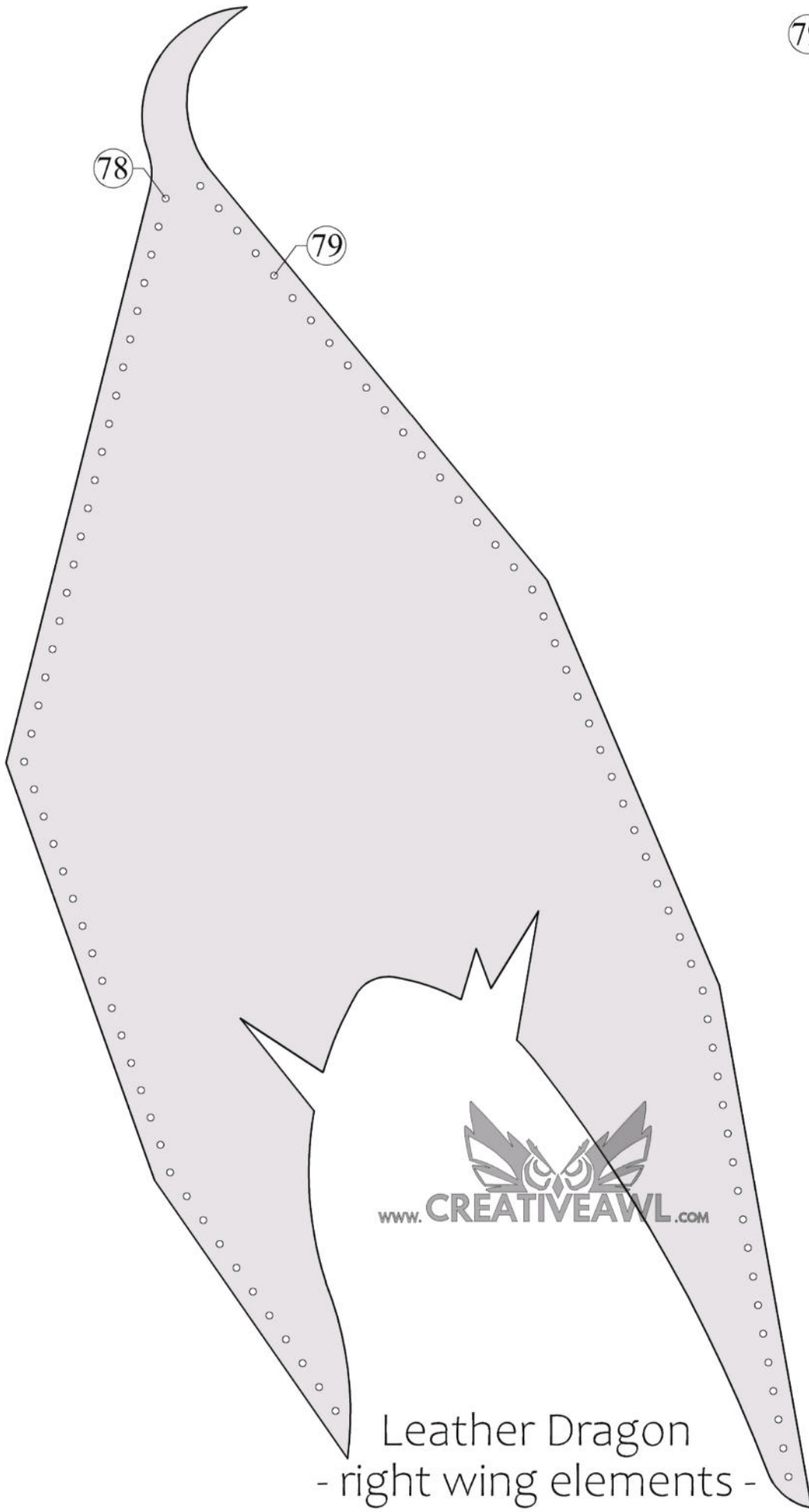

Leather Dragon
- right wing elements -

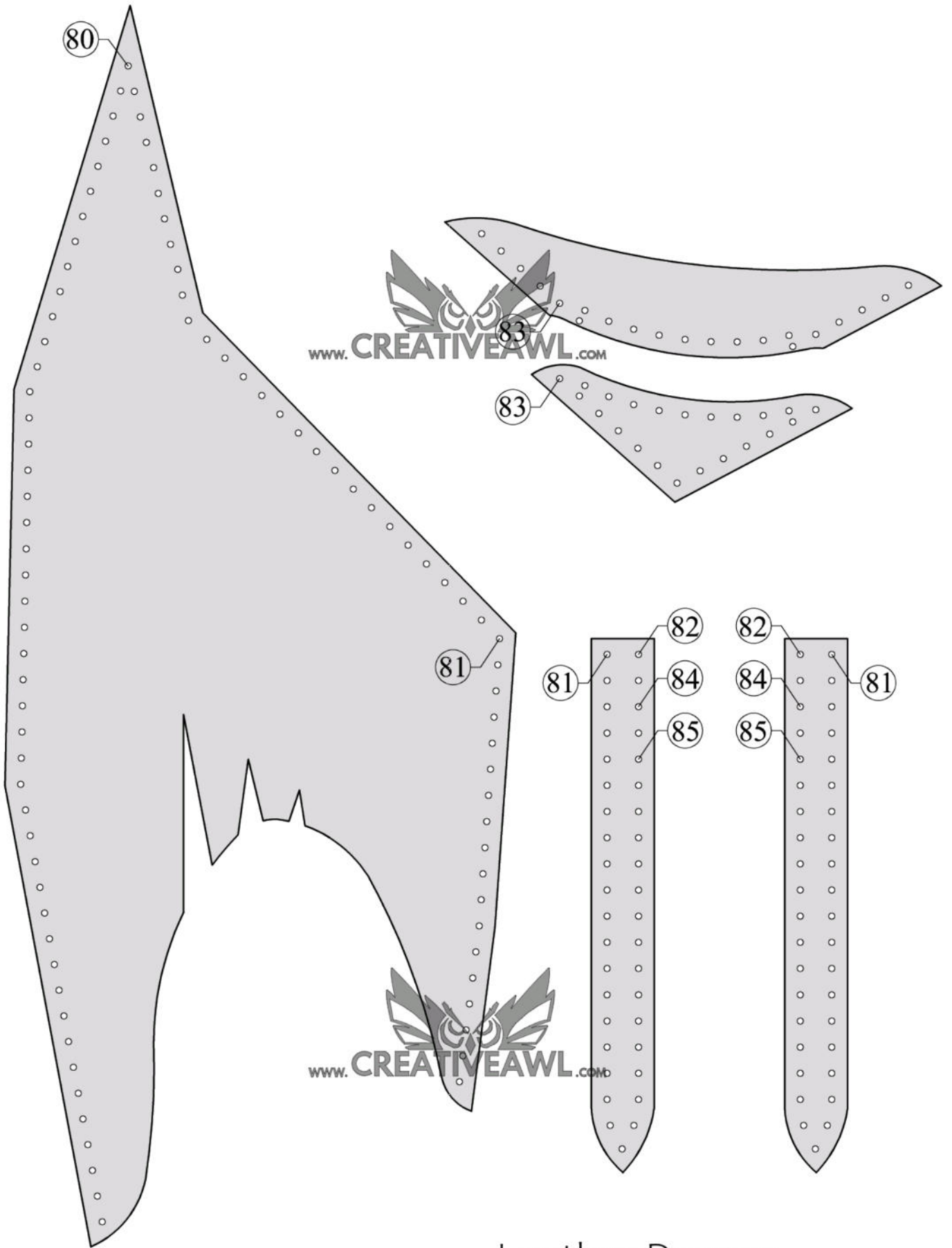

Leather Dragon
- right wing elements -

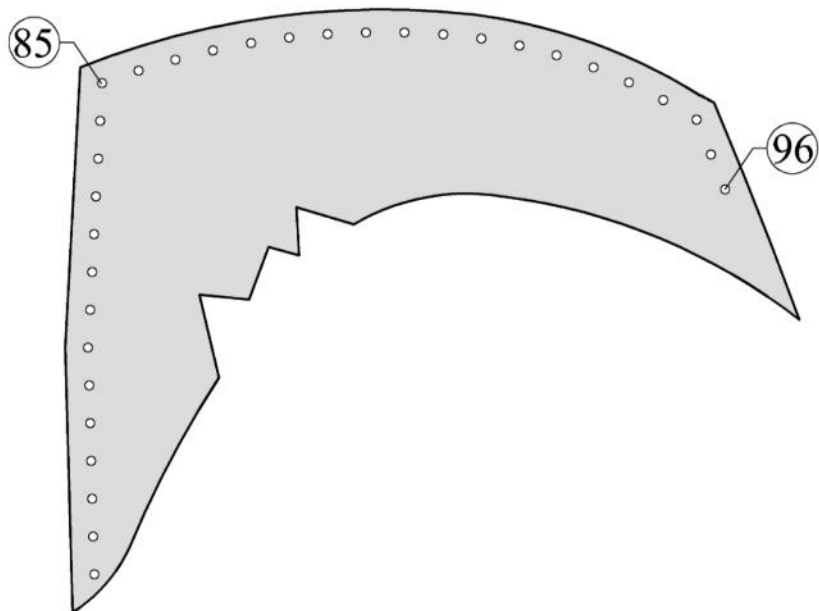
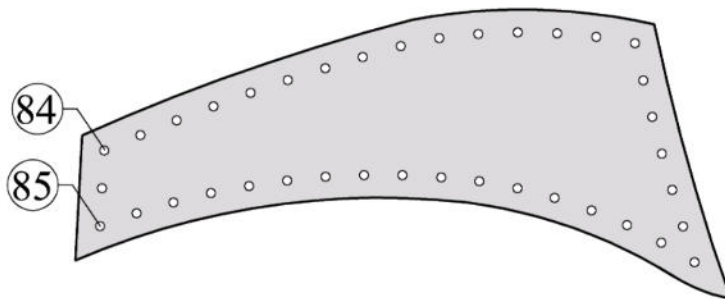
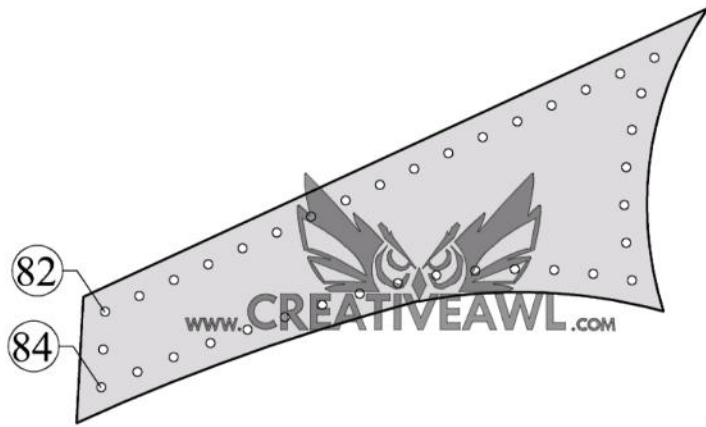

Leather Dragon
- right wing elements -

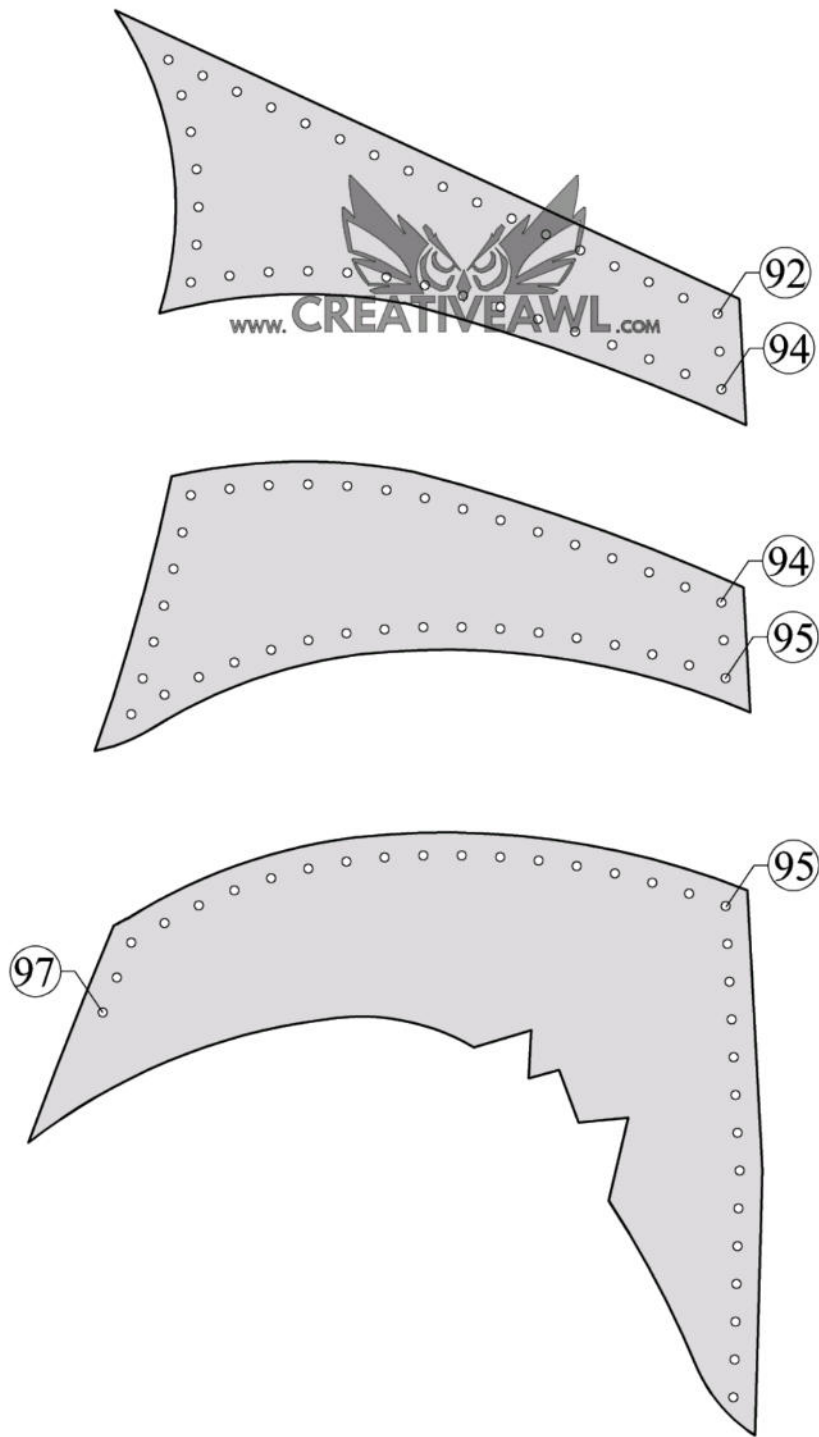

Leather Dragon
- left wing elements -

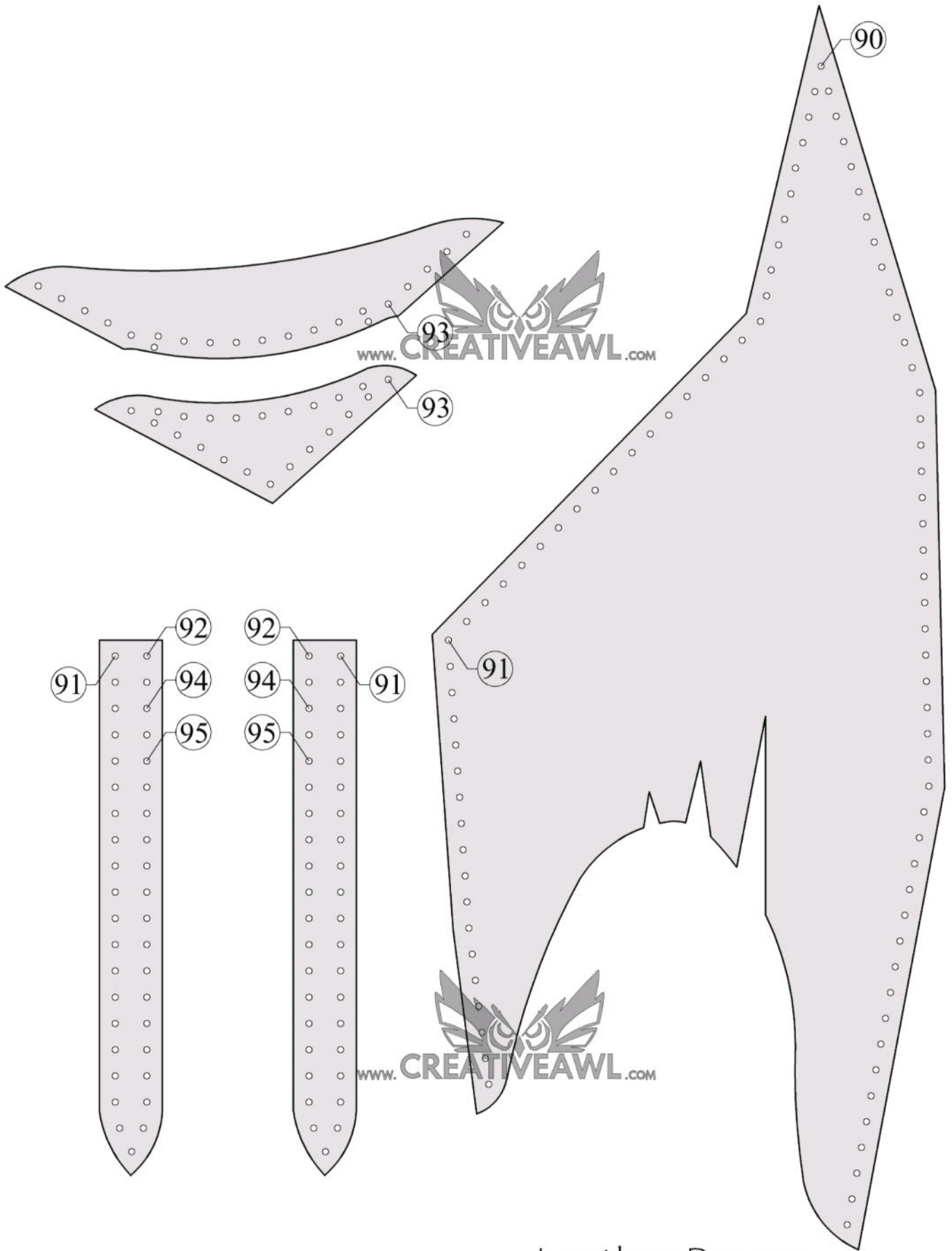

Leather Dragon
- left wing elements -

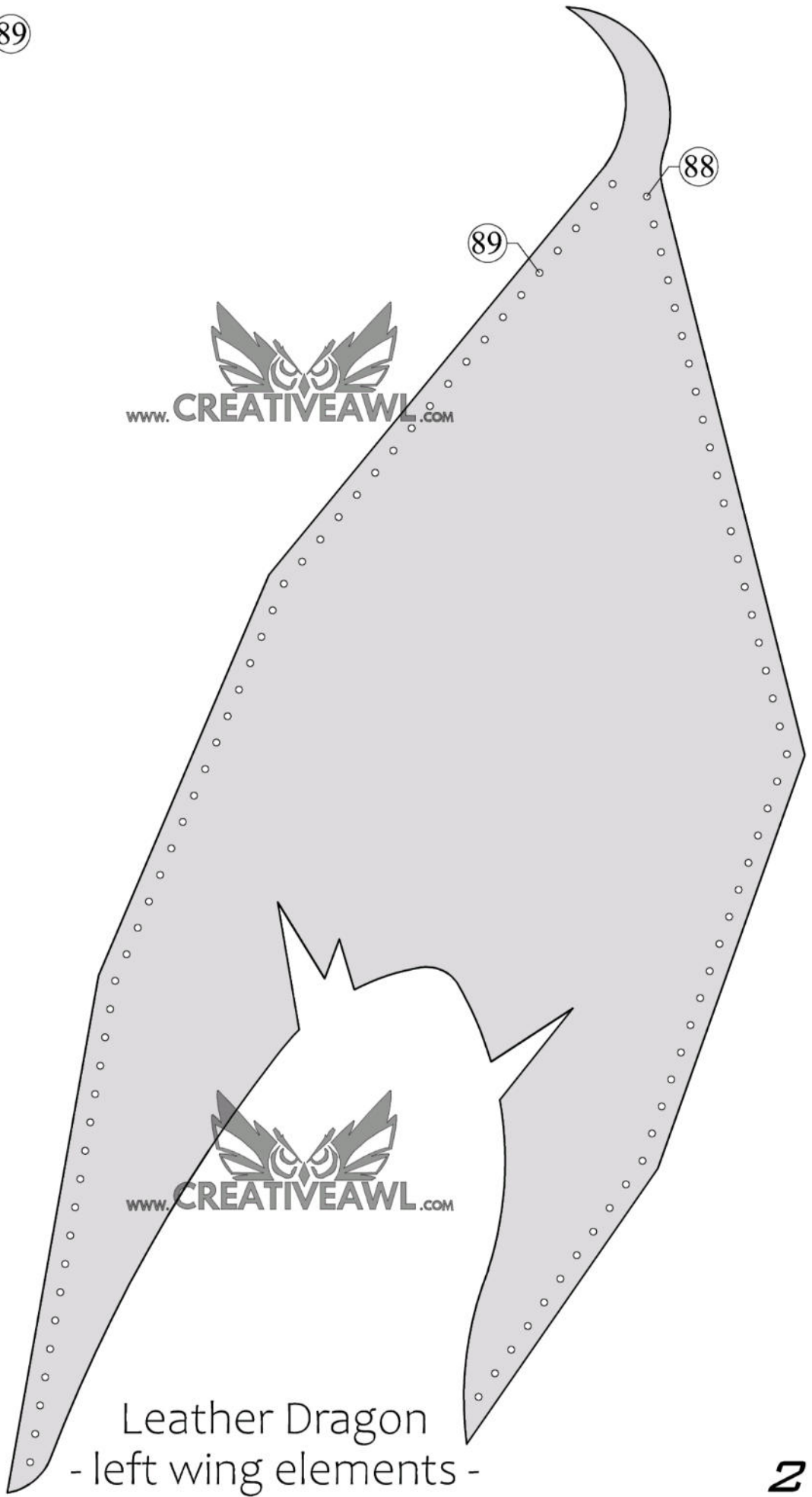
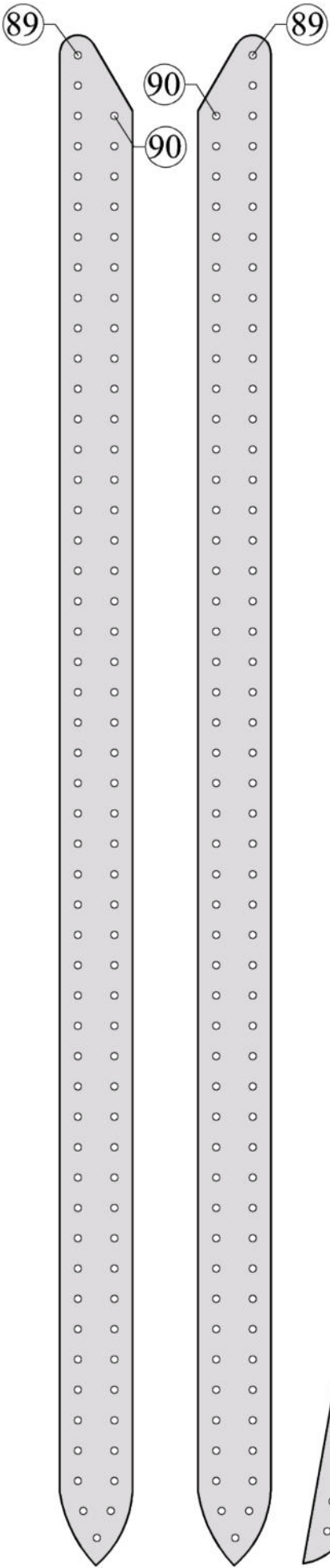

Leather Dragon
- left wing elements -

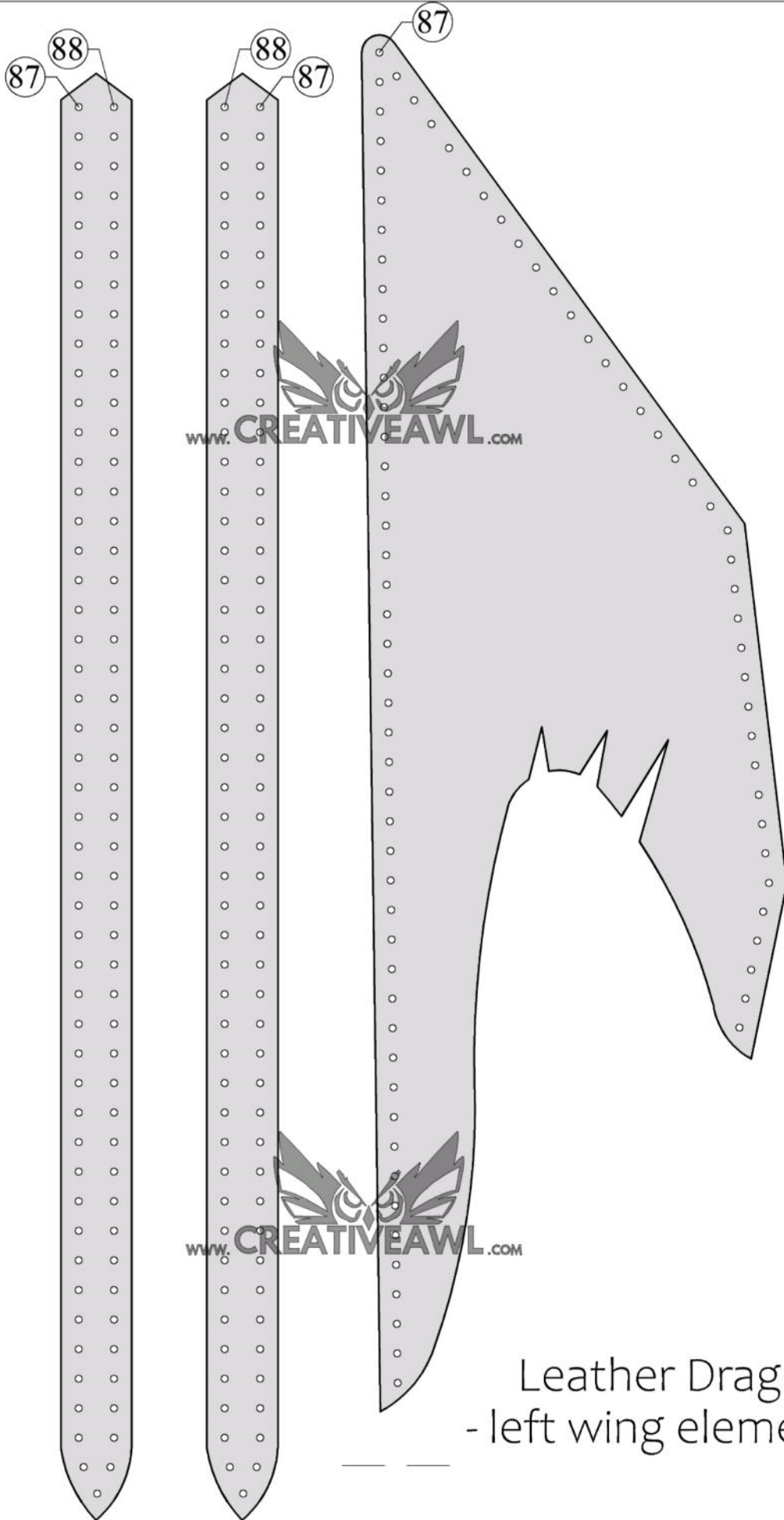

Leather Dragon
- left wing elements -

皮小匠图纸 <http://www.pixiaojiang.com>

参考视频 <https://www.bilibili.com/video/BV1ha411g7hi/>

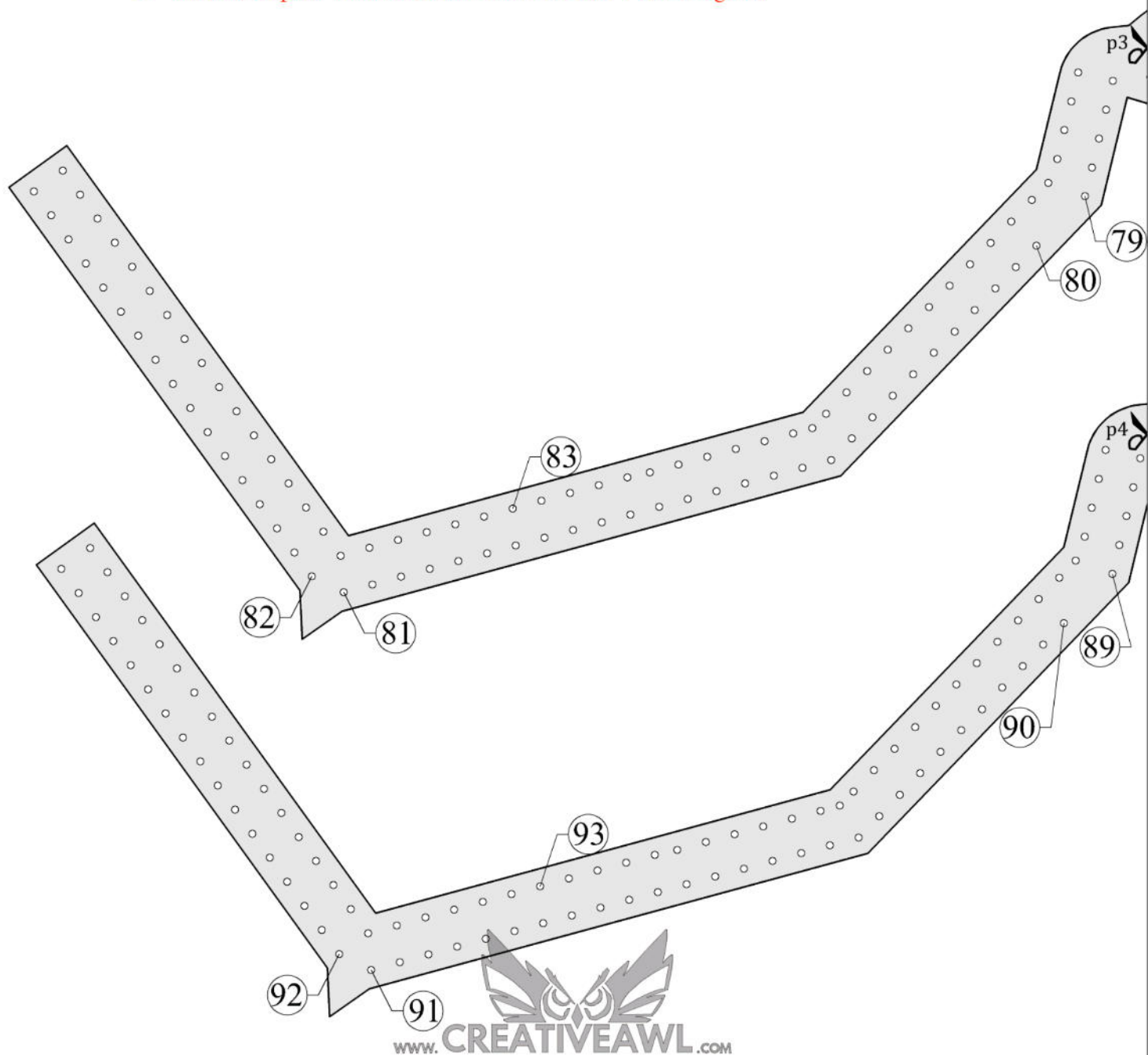

Leather Dragon
- left wing elements -

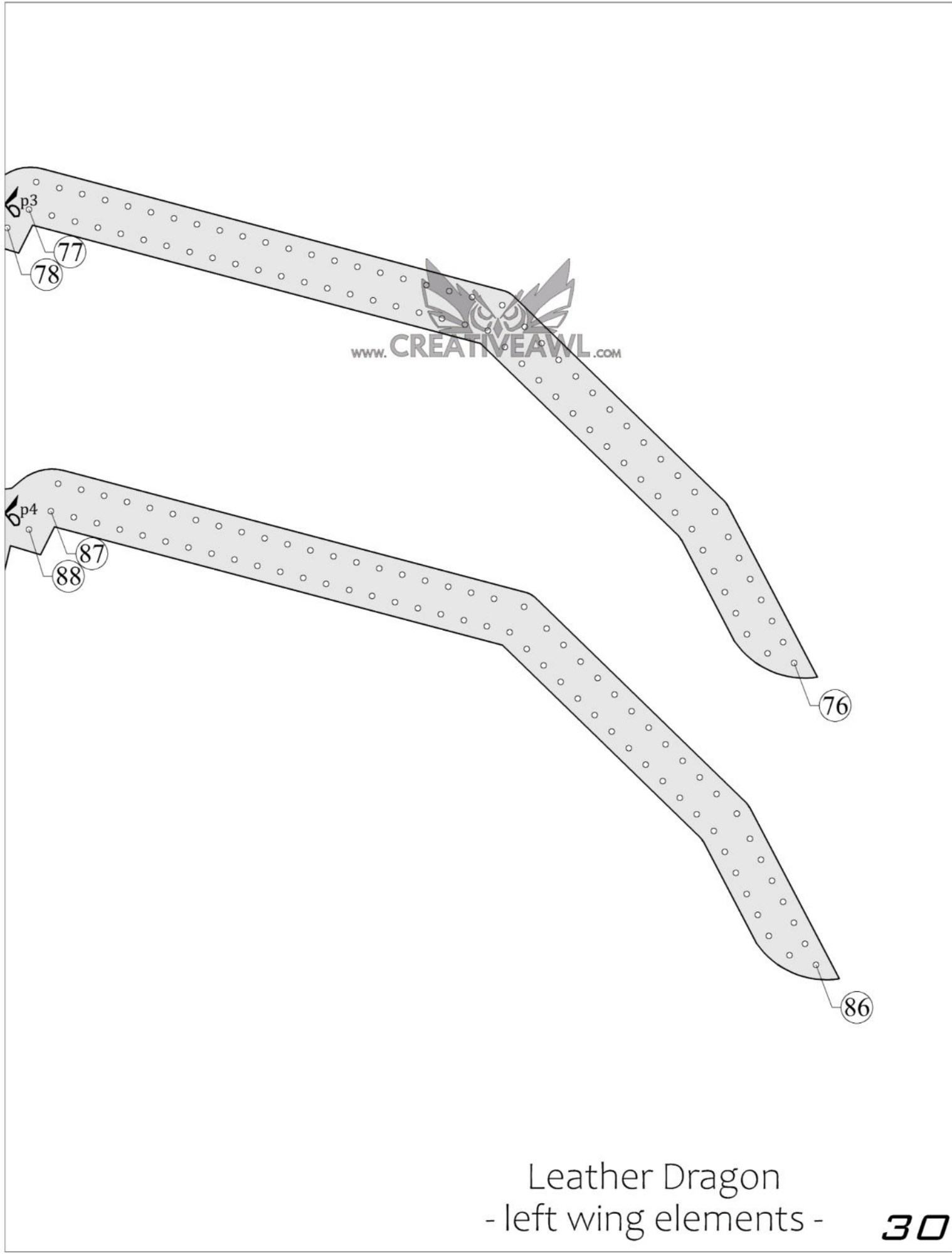

Leather Dragon
- left wing elements -