

[Video tutorial](#)

[Facebook community](#)

[Website](#)

[Etsy patterns shop](#)

[Instagram](#)

Goomba pattern



Measure for accuracy

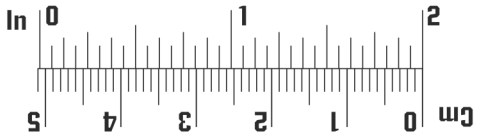

Match

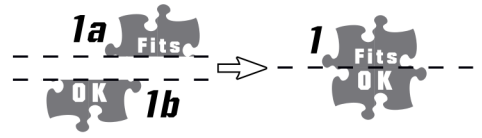

Punch



Cut

* Print on any type of paper by checking **Actual size** and selecting **US Letter** as the printing format.

* You will also require two rivets (we used 9 mm ones).

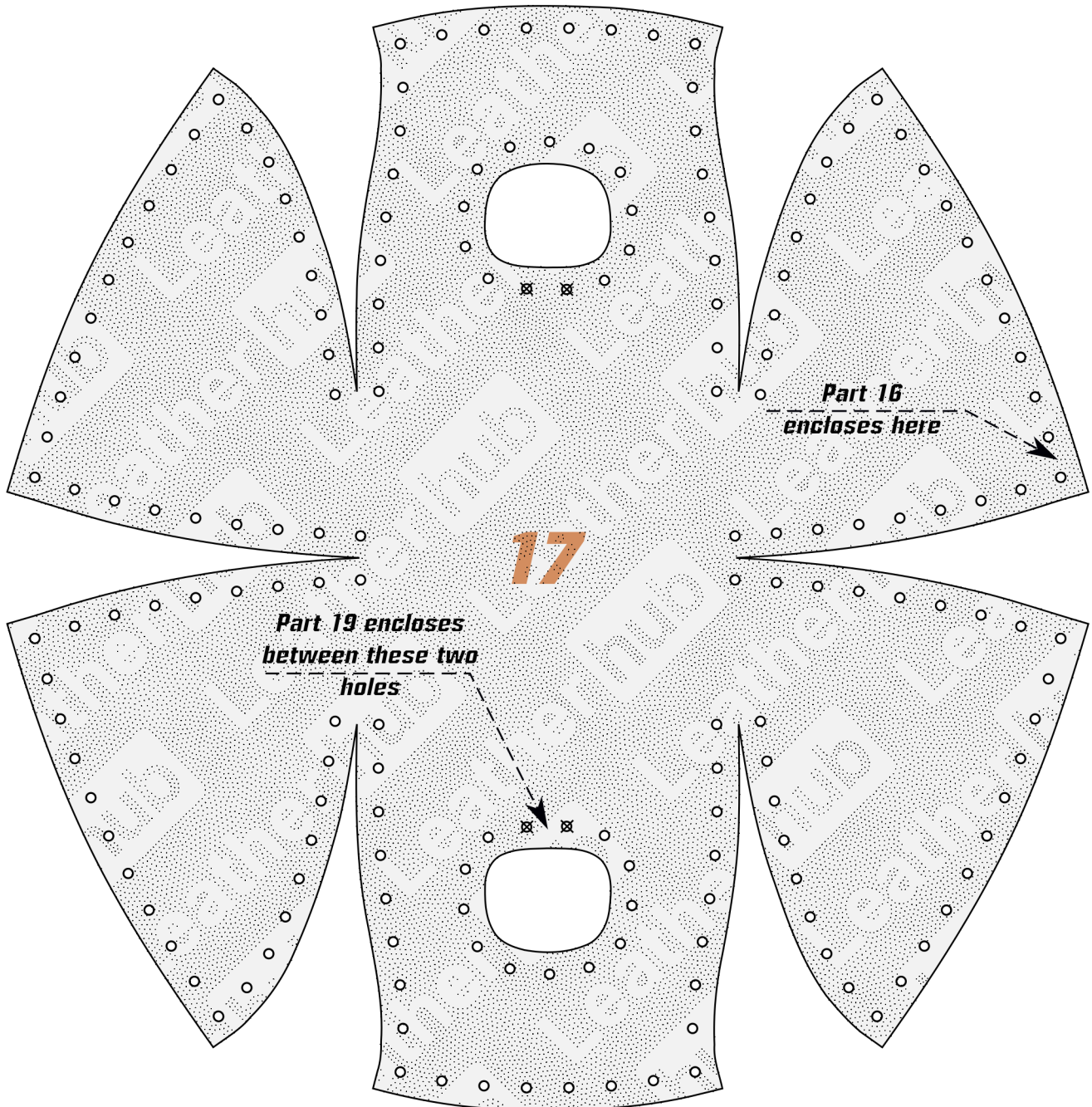

Rivet part
6 here



3

11b

12



1b

12



8

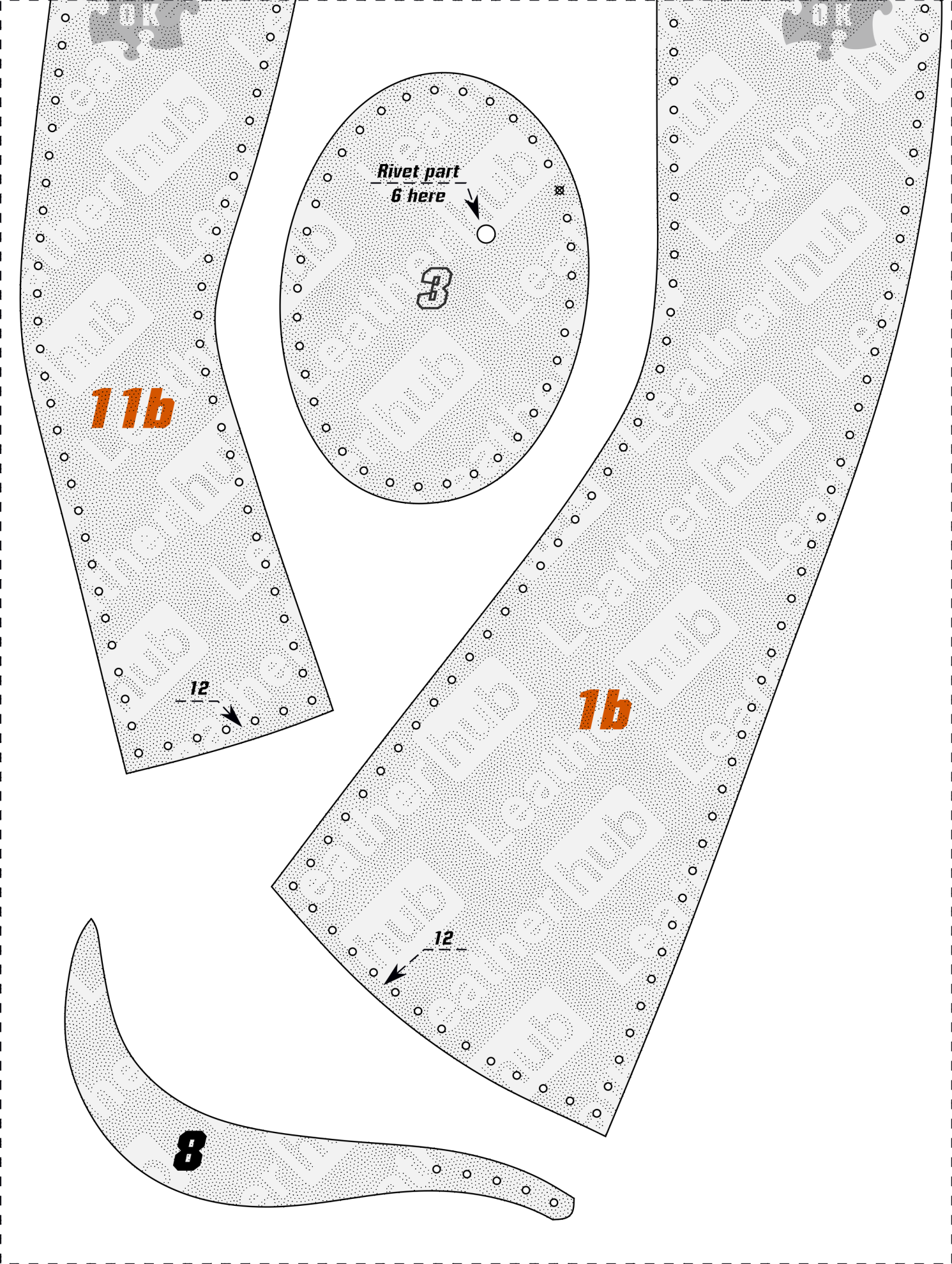

12b

15

9

2b

11

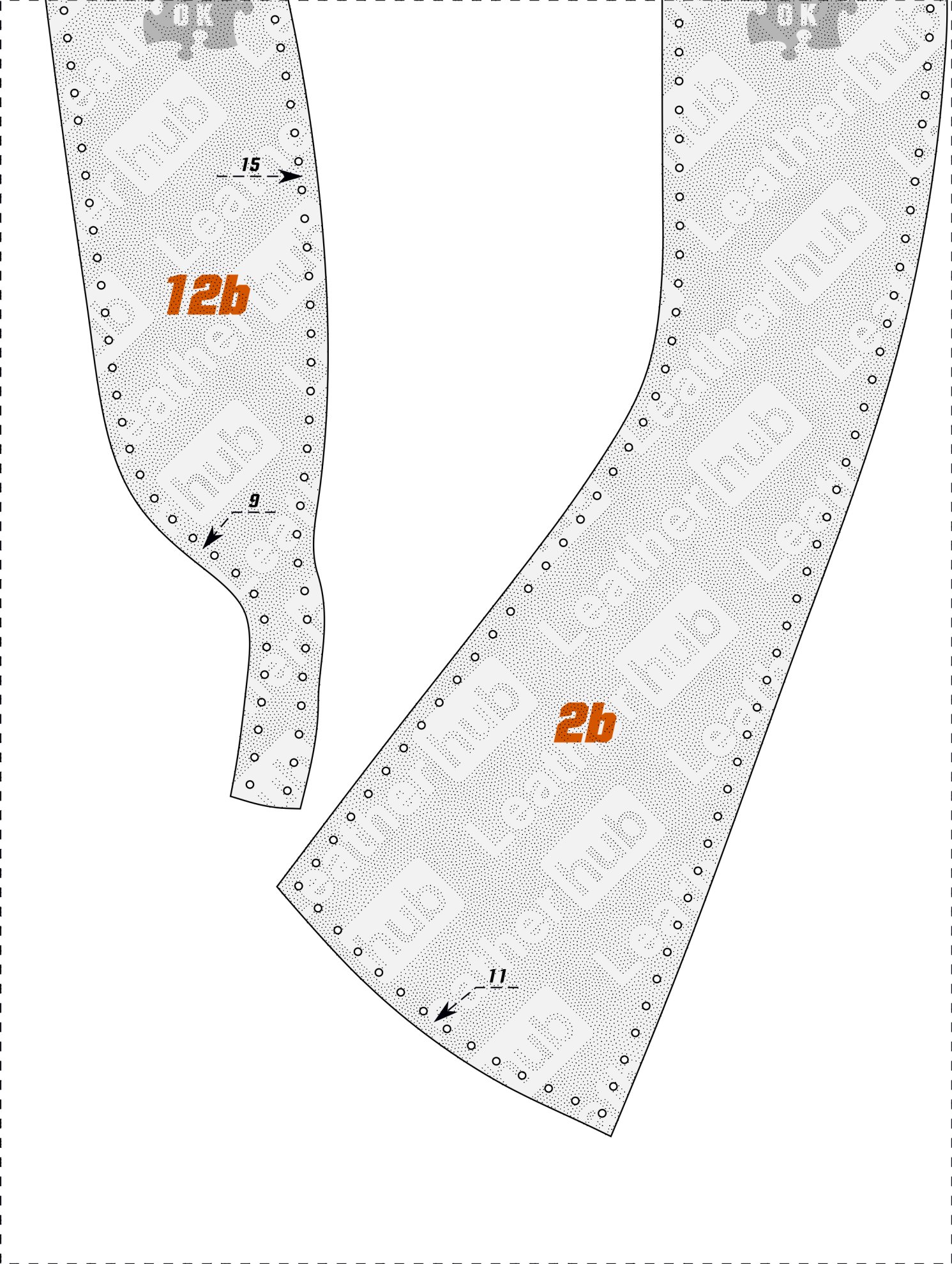

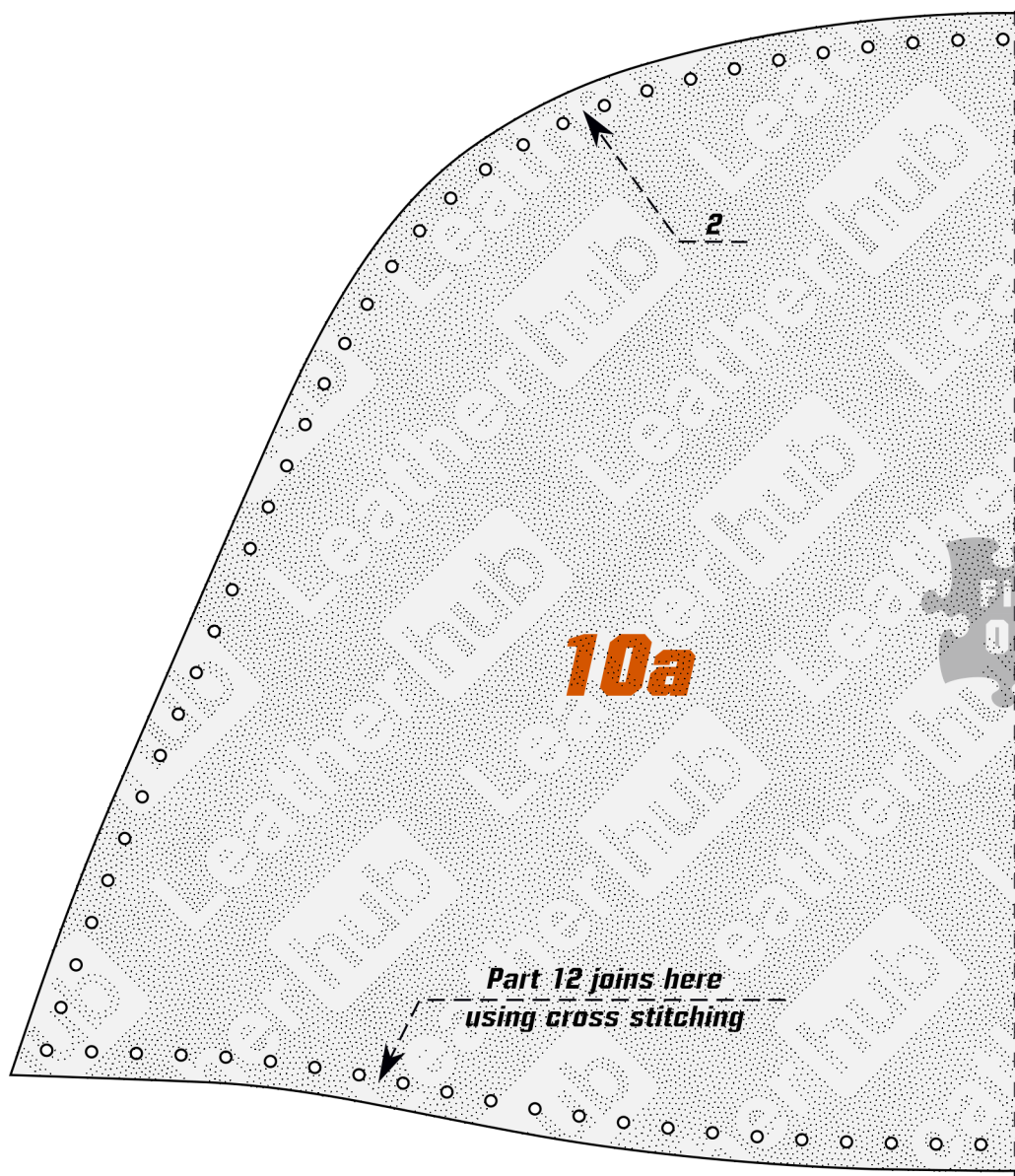
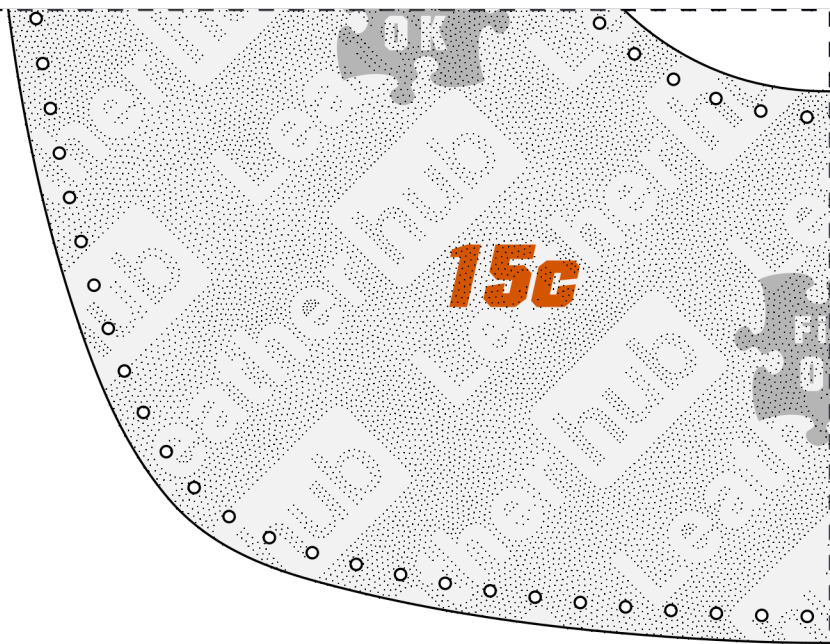
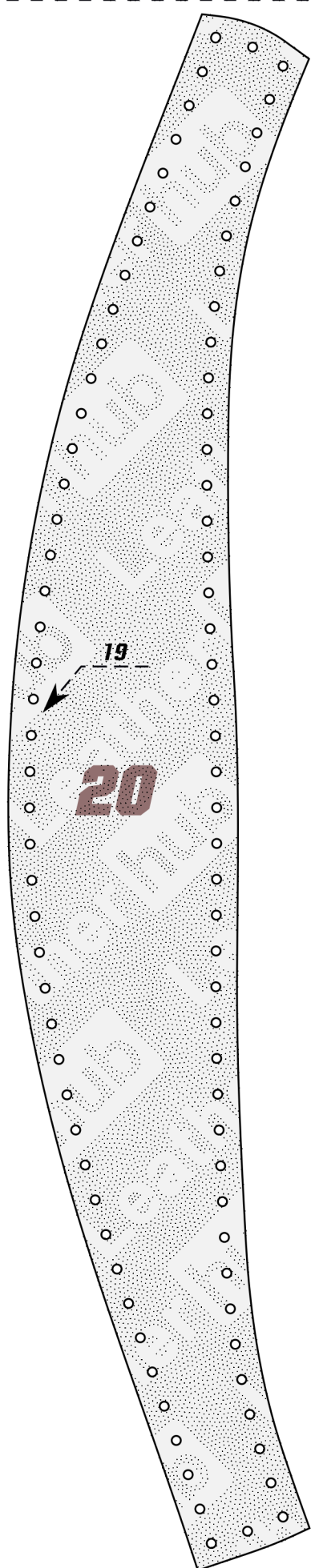

Part 16 encloses
here

15d

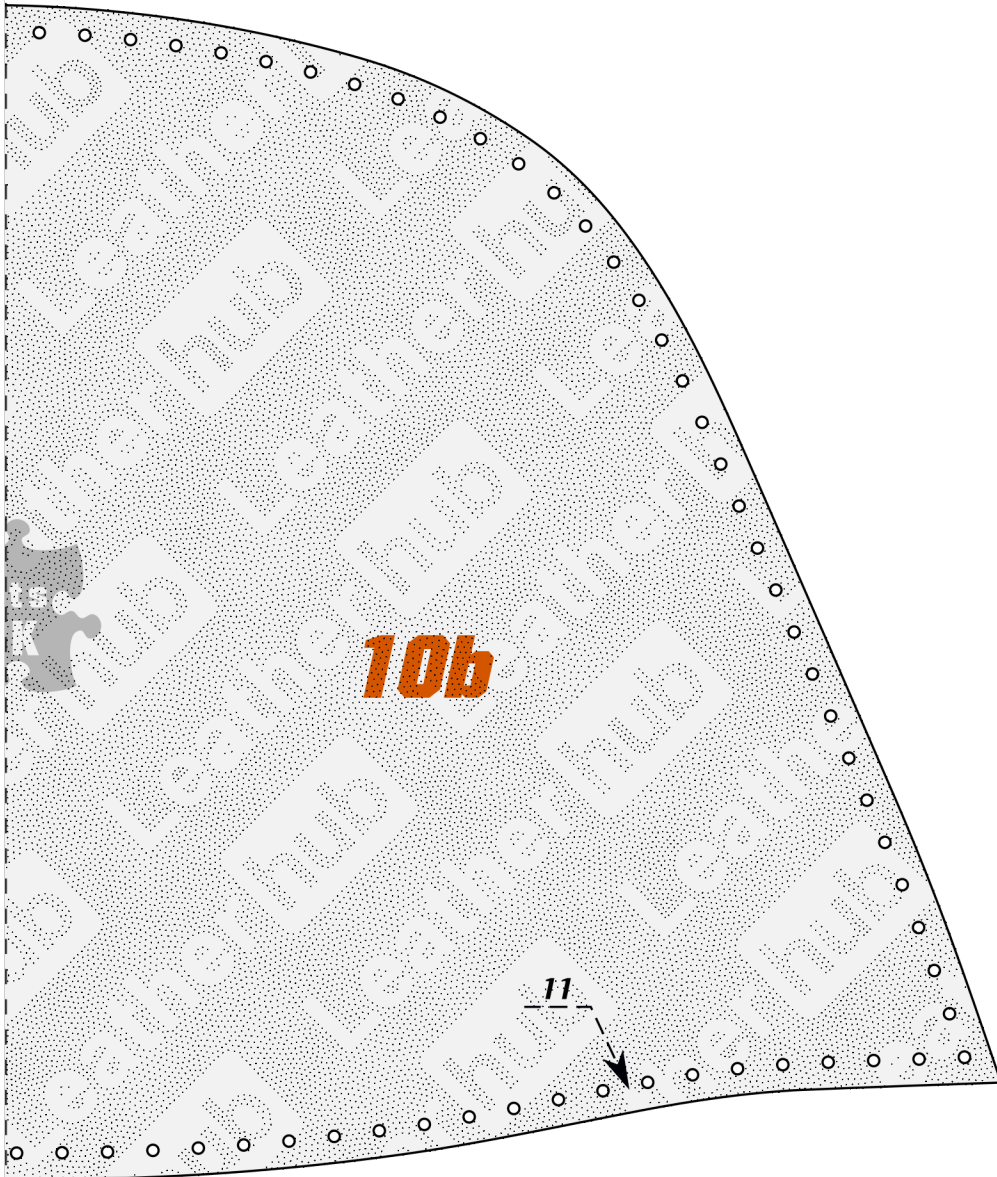
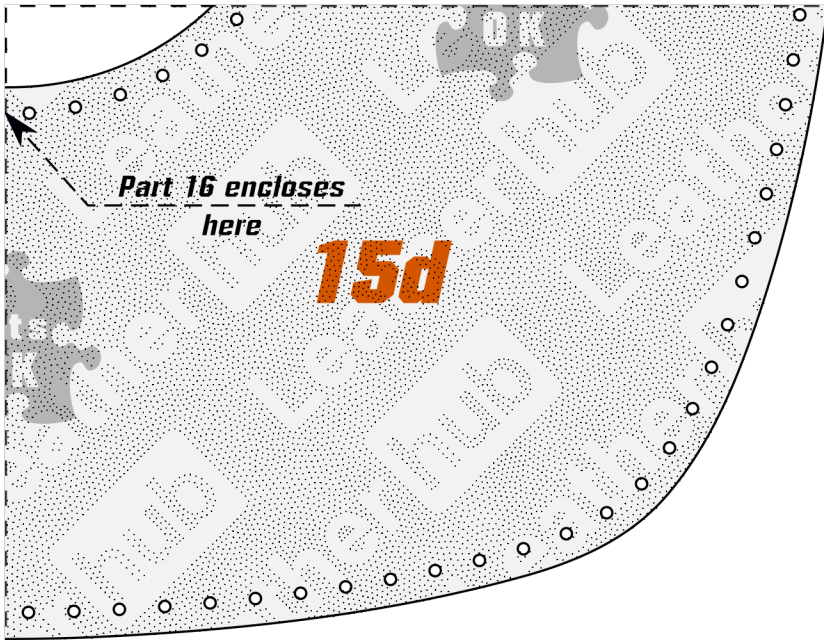

10b

11

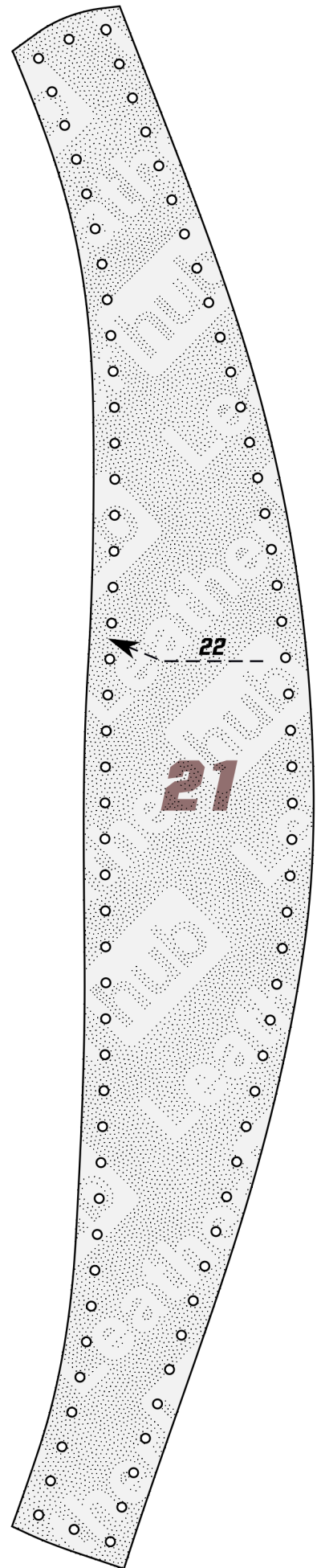

22

21

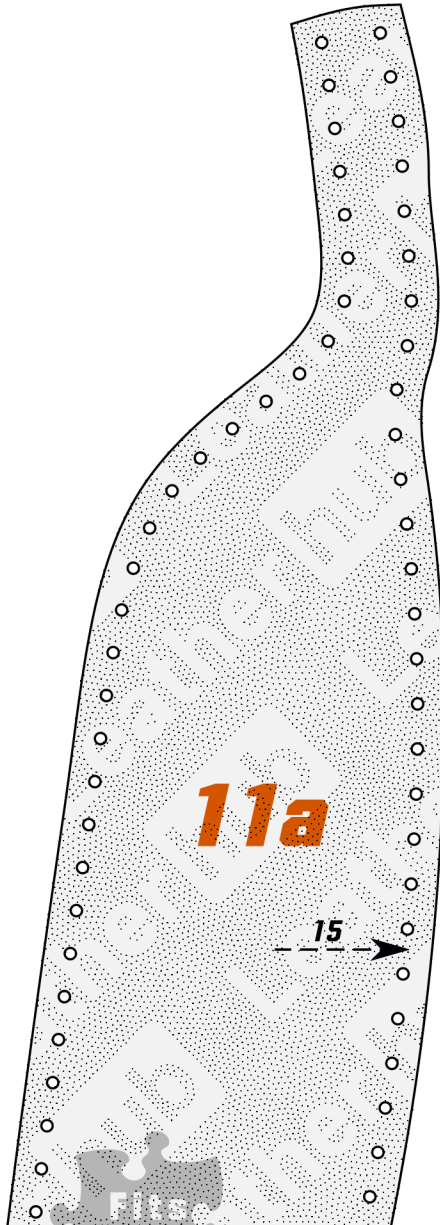
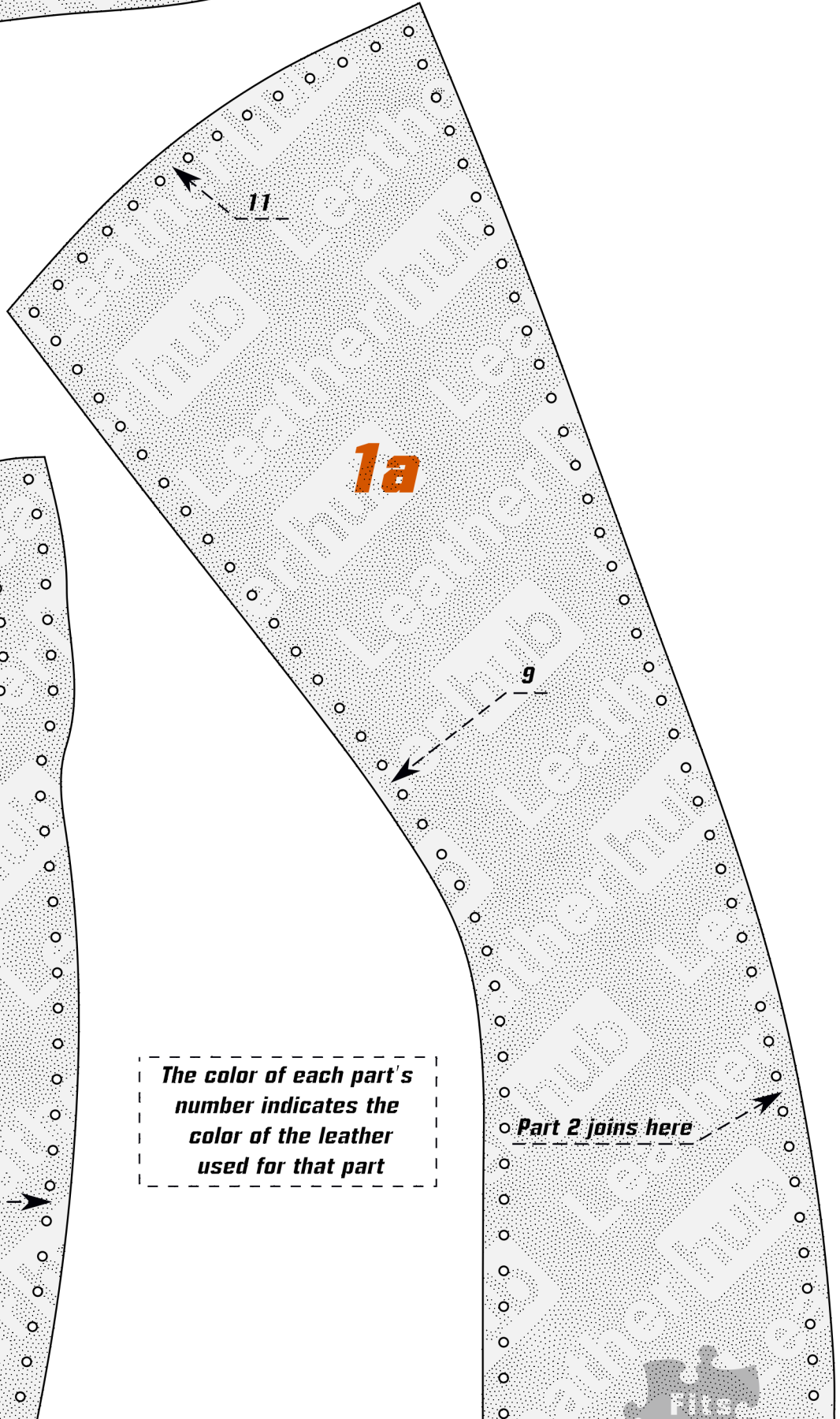
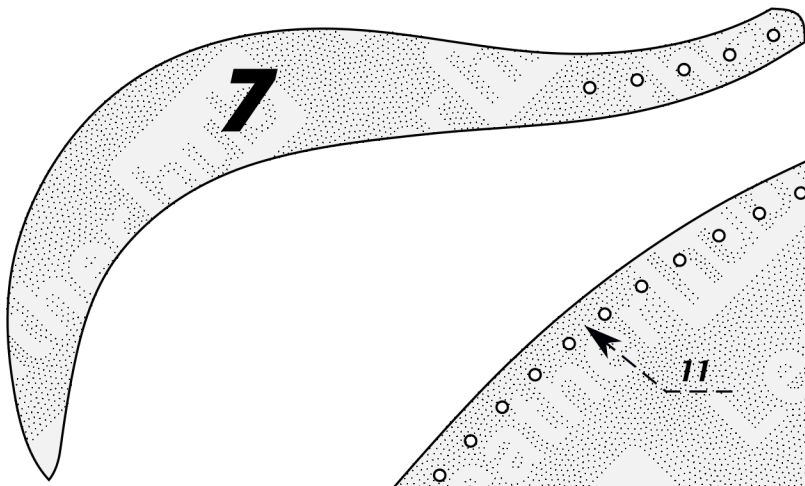

The color of each part's number indicates the color of the leather used for that part

Part 2 joins here

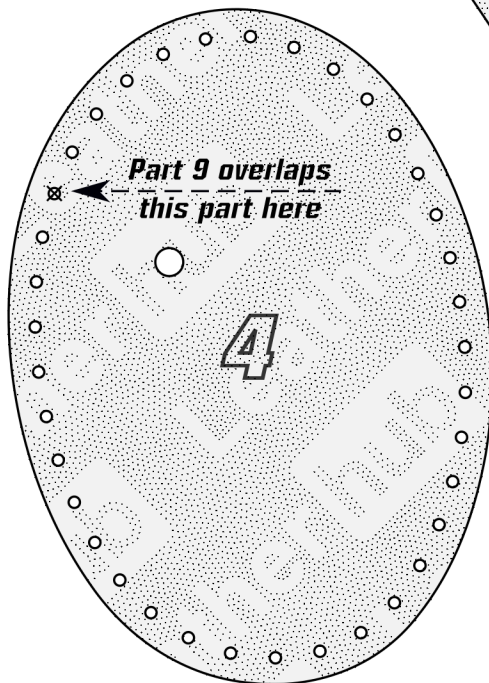
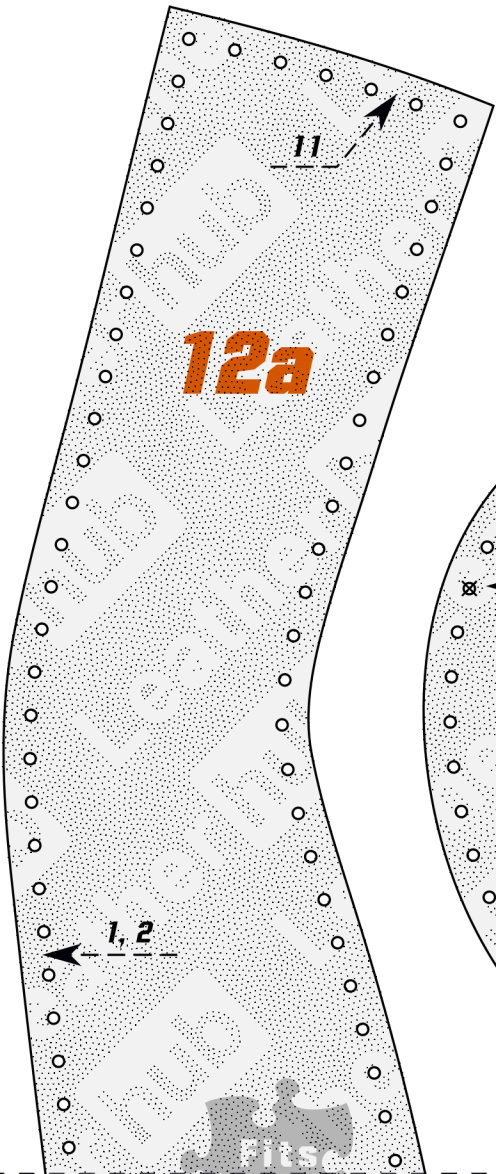
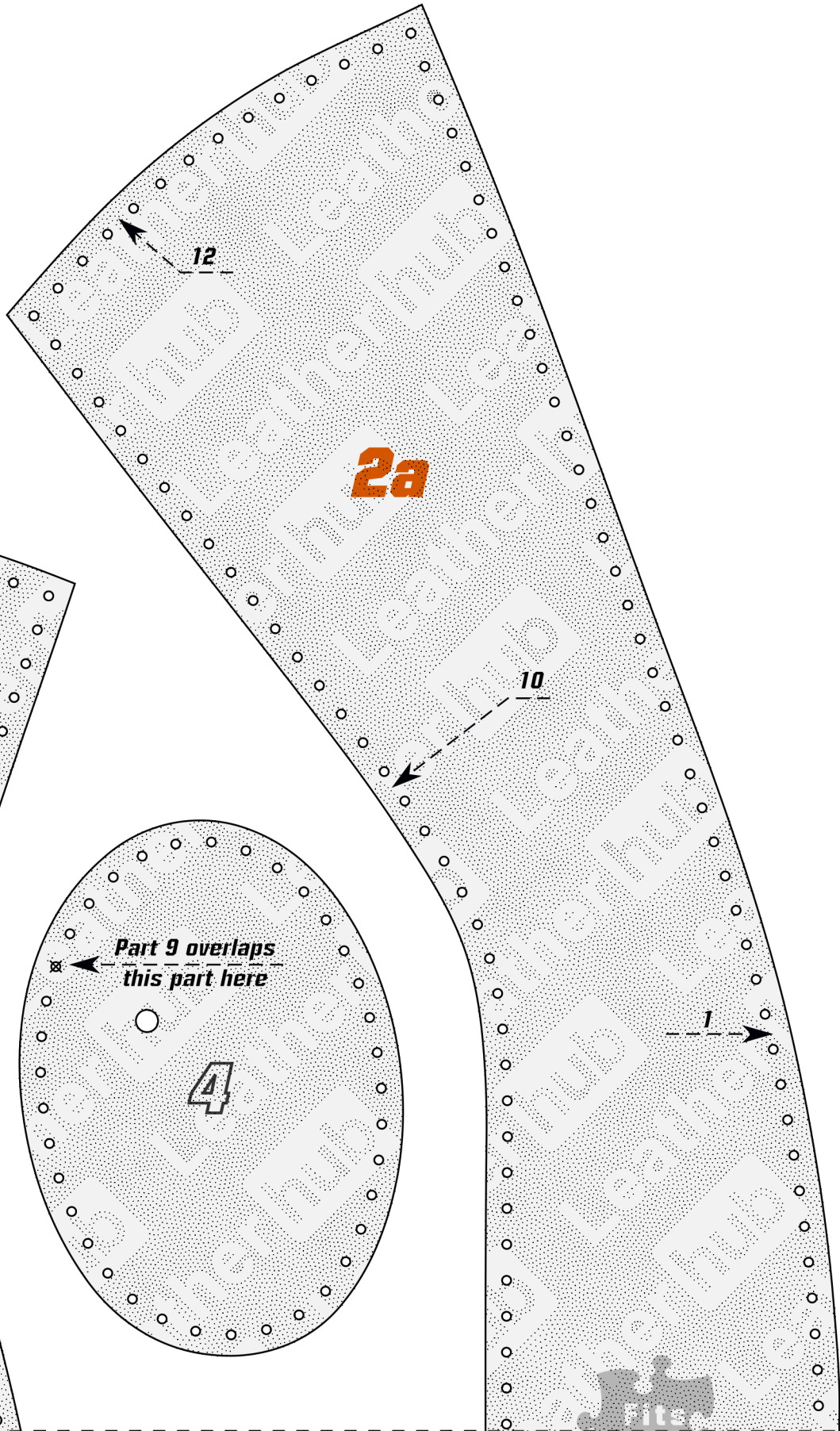

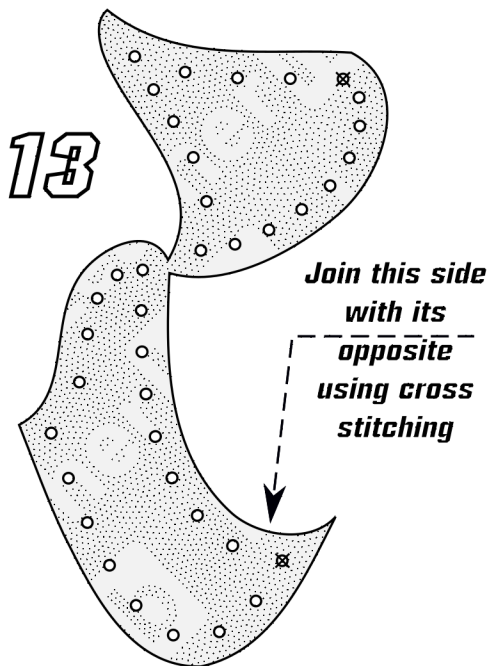
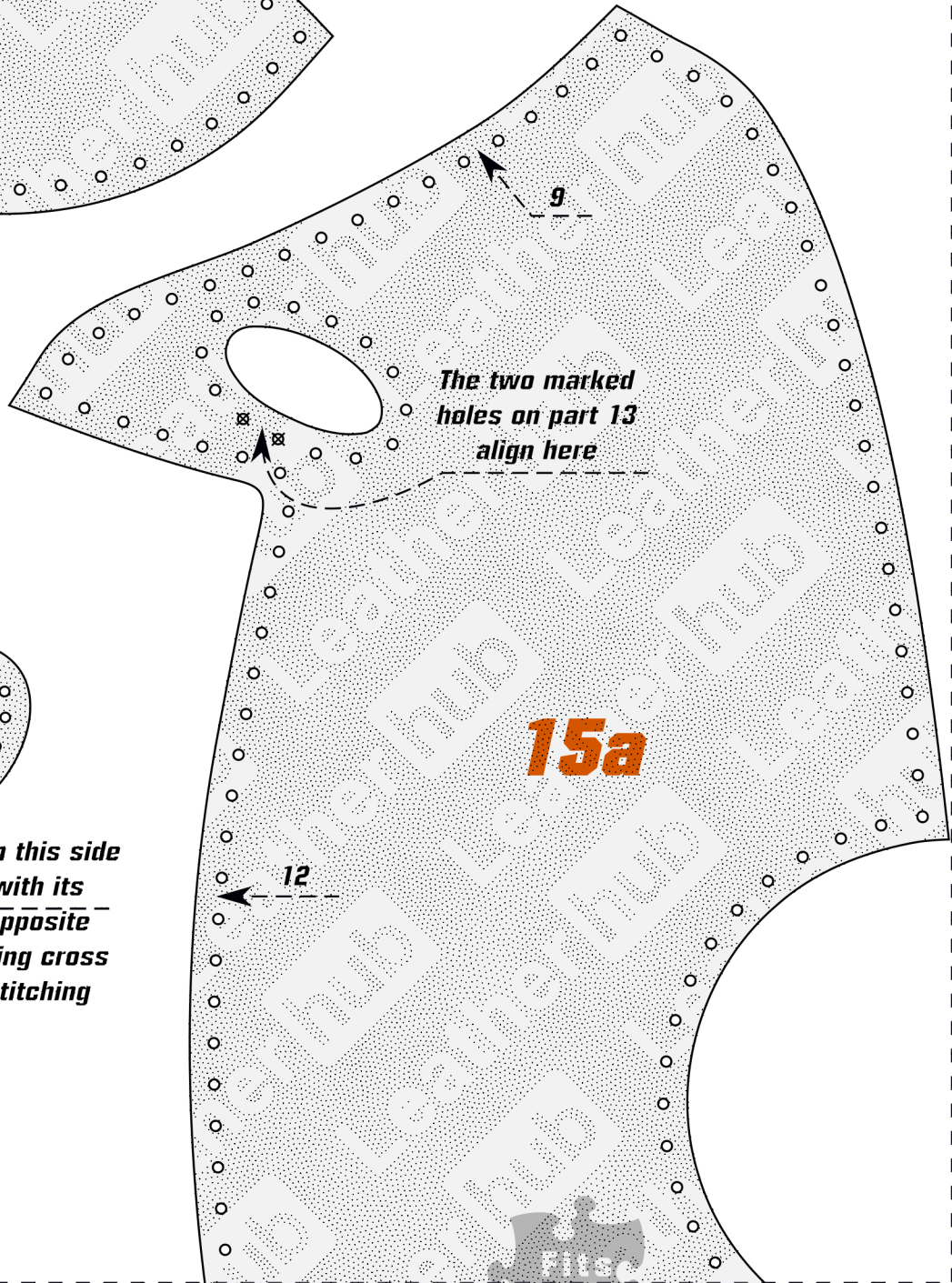
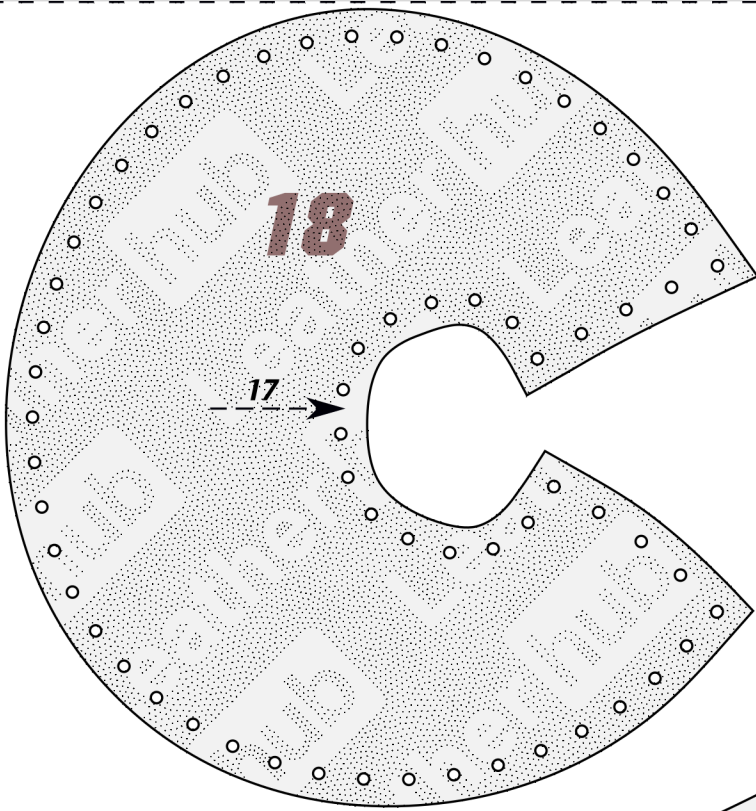

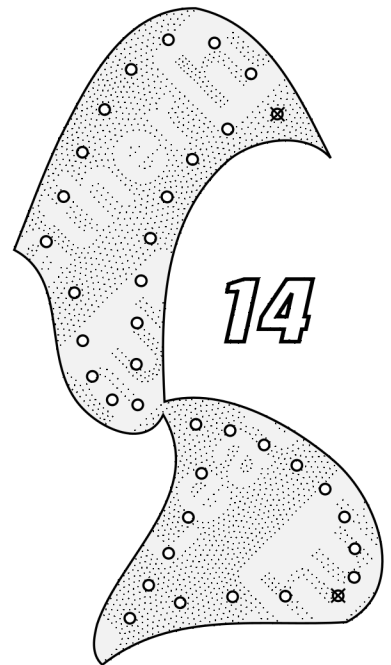
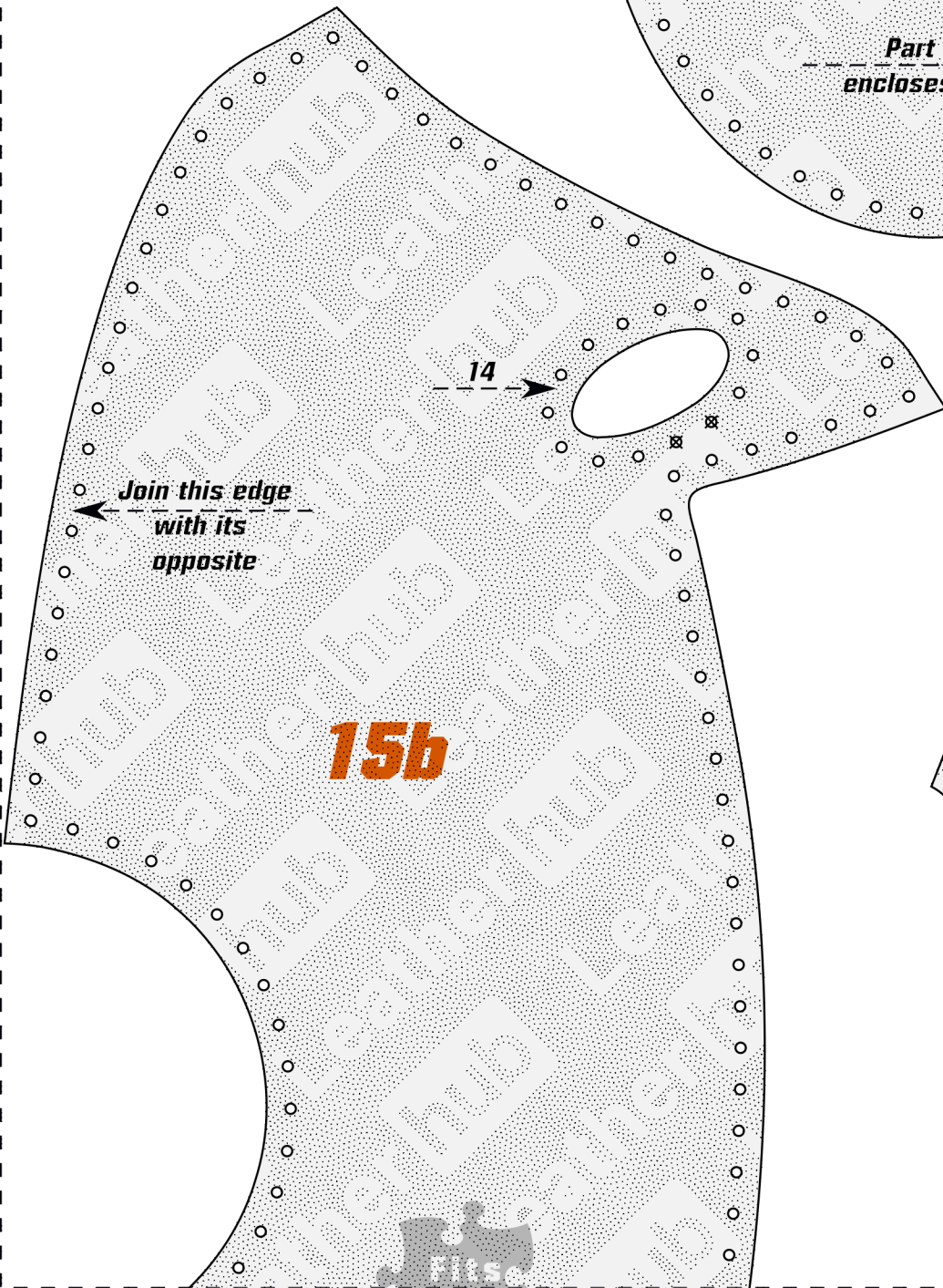
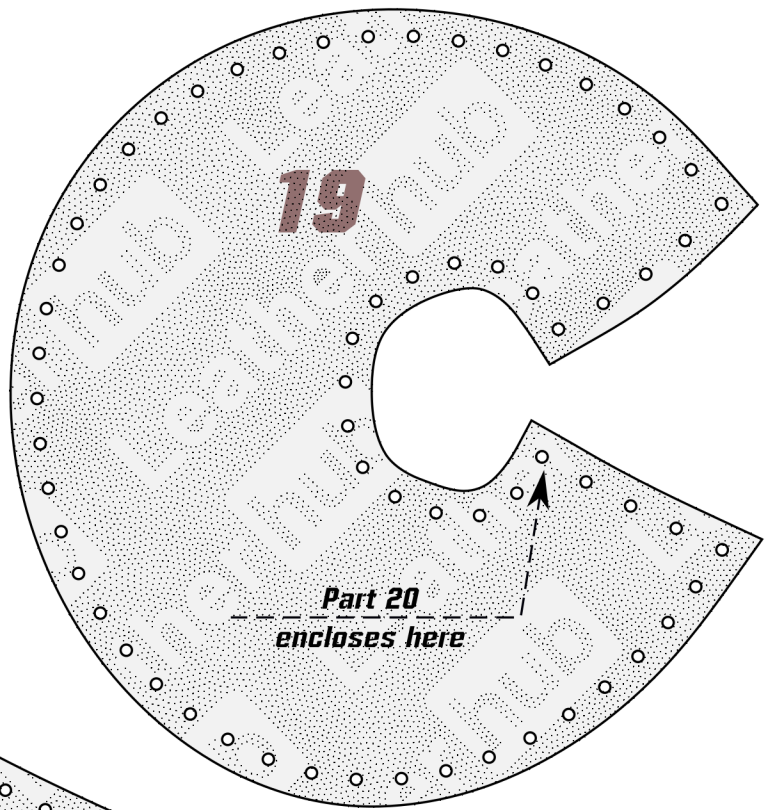

Join this end
with its
opposite

Part 7 overlaps
here

17

16

15

9a

3

15

