

Vintage Pattern Series

CAVALIER BILLFOLD PATTERN 4018



This card case billfold has two accessible card pockets plus a “hidden” pocket behind the left pocket. Plus, a space to hold currency. Closed size 3-1/2x4-1/4”.



LeathercraftLibrary.com
DIGITAL MEDIA FOR LEATHERCRAFTERS



Digital Downloads

This PDF package has been put together to give you options when it comes to printing. Some PDF file downloads may contain some documents larger than an 8-1/2" x 11" image. Pages and patterns that are larger than 8½x11 have been provided in two formats:

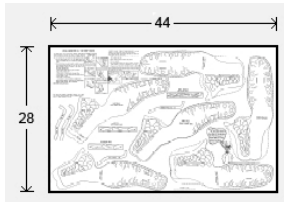

Full Size: If you would like to have a full size print out, take the full size pages to your local print shop and they can print it for you.

Tiled: The tiled pages give you the option of printing the larger patterns at home. You print the tiled pages and then assemble them to make the larger patterns.

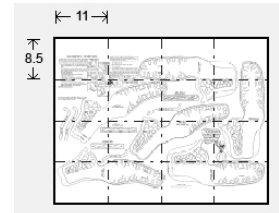

Pattern PDF files are typically laid out as follows: Cover (if applicable), instructions sheets (if applicable), pattern 1 – full sized, pattern 1 – tiled, pattern 2 – full sized, pattern 2 – tiled, pattern 3 – full sized, pattern 3 – tiled. ...Etc.

Doodle Page PDF files are typically laid out as follows: Front – full sized, front – tiled, back – full sized, back – tiled (Some Doodle Pages do not have backs).

eBook PDF files contain 1 (one) full eBook. All pages in the PDF are full sized. This means that you may have to take the PDF to a print shop for certain oversized books if your home printer cannot print the larger pages.

Craftaid PDF files contain 1 (one) full Craftaid pattern or Craftaid pattern pack that has been converted into a tracing pattern. All pages in the PDF are full sized. This means that you may have to take the PDF to a print shop for certain oversized Craftaid patterns if your home printer cannot print the larger pages. **NOTE: These digitized patterns do not include any of the physical plastic templates (Craftaids) that may be mentioned, nor does the purchase of this PDF file imply a promise to receive any physical plastic templates (Craftaids).**

NOTE: Digital kit patterns do not include any kit parts that they may reference.

Please note: When printing on a home printer, use the settings seen on the image to the right in the Page Handling area of the Adobe Reader print dialogue box. If your printer is cutting edges off, set "Page Scaling" to "Shrink to Printable Area". This will, however, decrease the size of the pattern a very small amount.

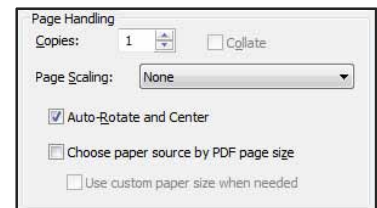

NOTE: Some patterns may reference tools, and other items no longer available.

NOTE: You may take this PDF file to your local print shop to have the full-size pages printed for your own personal use.

This premium has been published by Tandy Leather Factory, 1900 South East Loop 820, Ft. Worth, TX 76140. Copyright © 2011 by Tandy Leather Factory, all rights reserved. The contents of this publication may not be reproduced either in whole or in part without the consent of the copyright owner.

Please respect the copyright by not forwarding or distributing this document.

CAVALIER BILLFOLD INSTRUCTIONS

STOCK NO. 4018



KIT CONTAINS:
 Pre-Cut, Pre-Punched Natural Tooling Leather Back
 Pre-Cut, Pre-Punched Bonded Leather Insides
 Leather Lace
 Lacing Needle
 Patterns and Instructions

YOU WILL NEED:
 Rubber Cement
 Tools For Design



Distributed by Tandy Warehouse Co.
 A Division of Tandy Crafts Inc.
 Fort Worth, Texas 76107

KIT PARTS

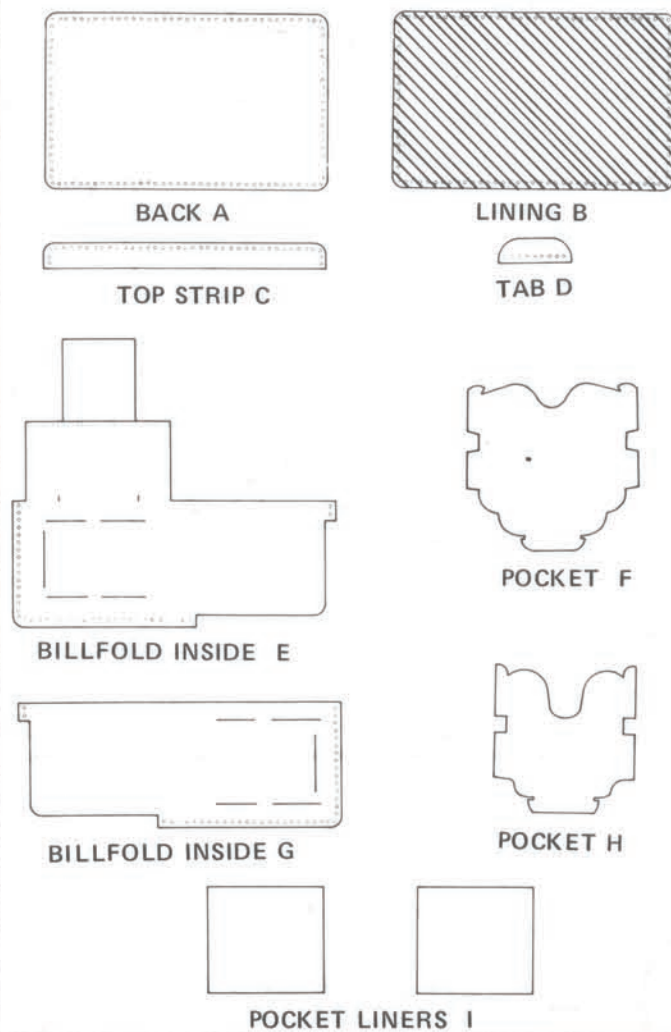

DOUBLE LOOP INSTRUCTIONS

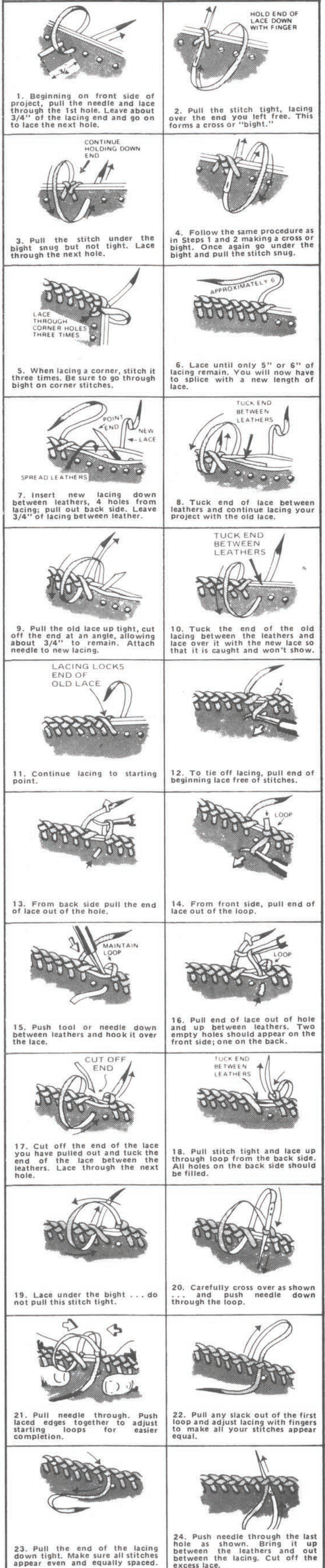

ASSEMBLY INSTRUCTIONS

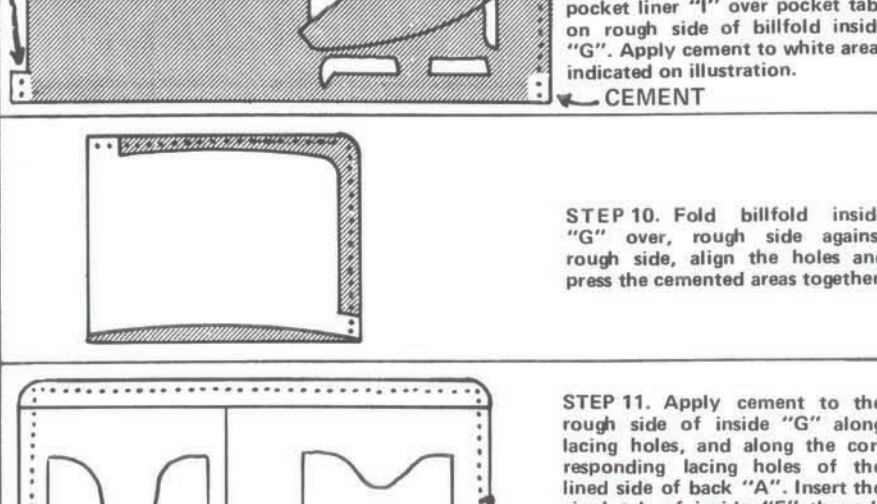
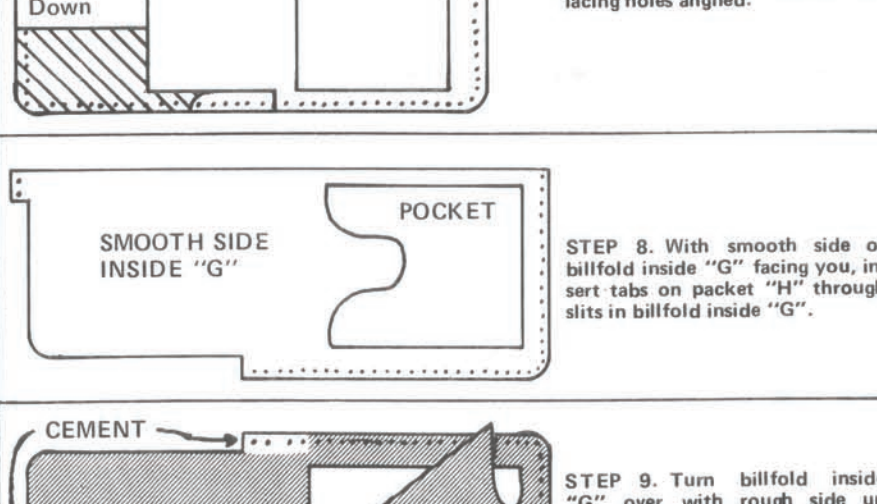
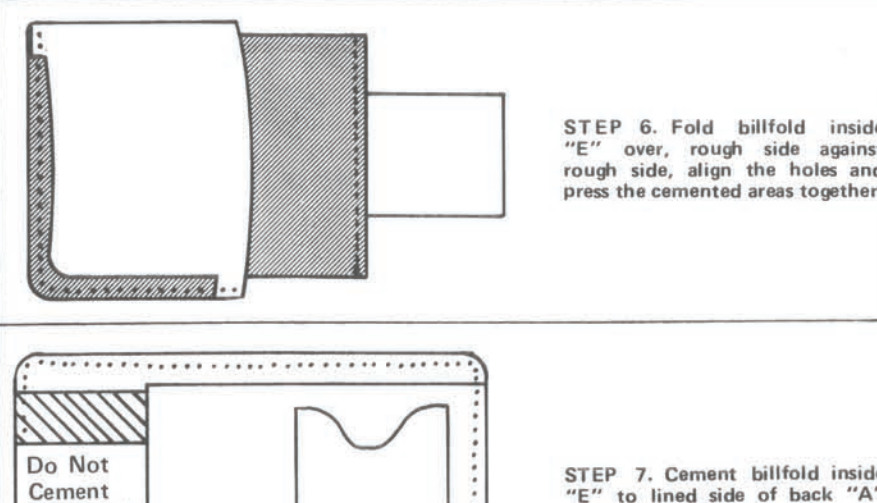
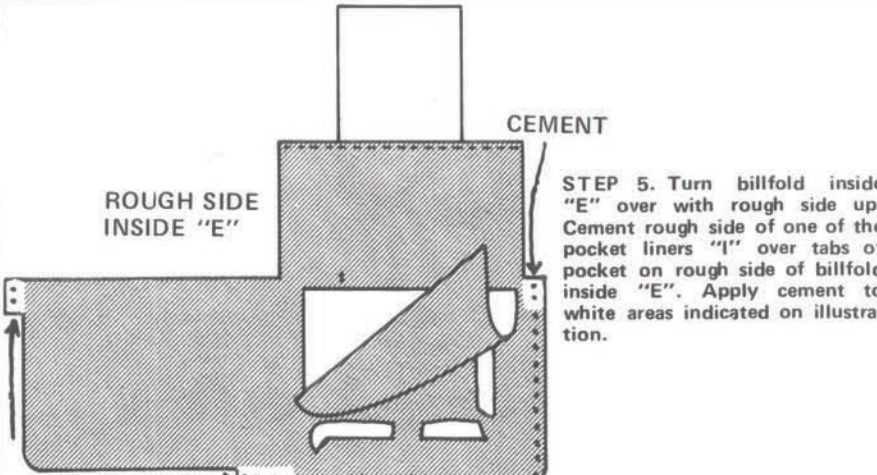
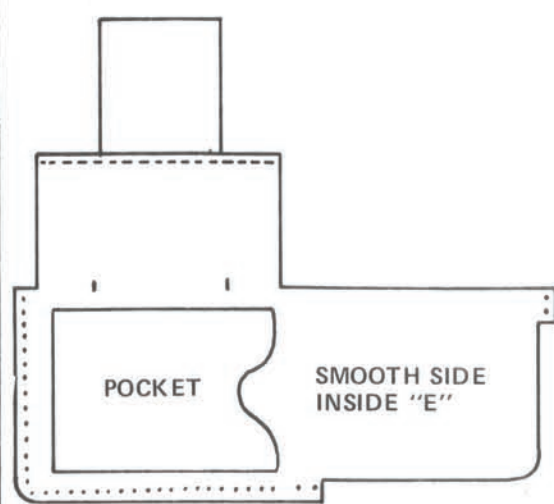
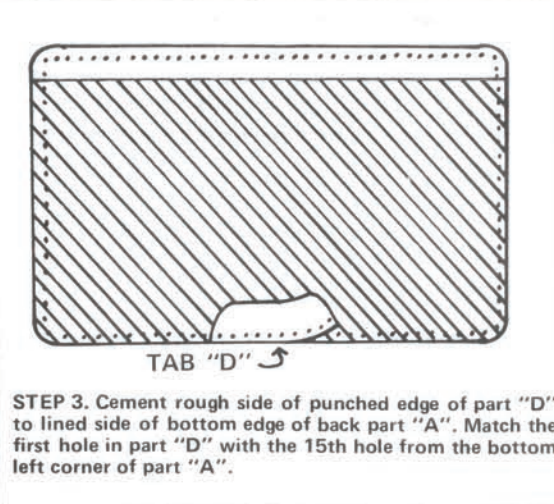
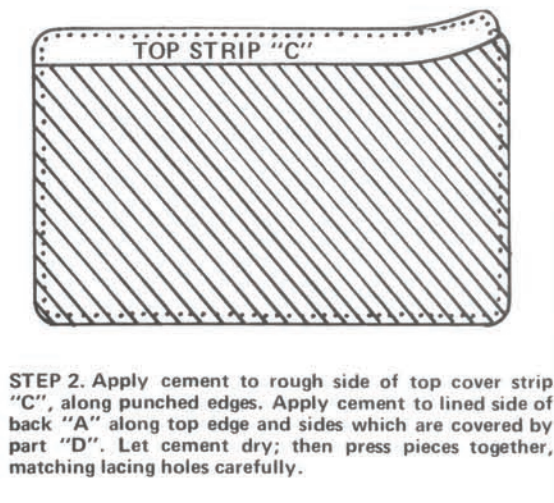
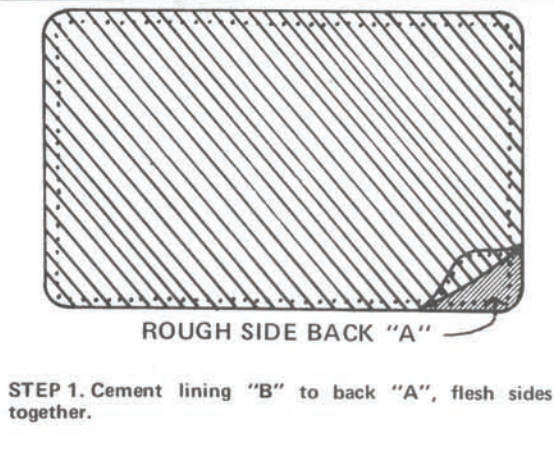

CAVALIER BILLFOLD INSTRUCTIONS

STOCK NO. 4018



KIT CONTAINS:

- Pre-Cut, Pre-Punched Natural Tooling Leather Back
- Pre-Cut, Pre-Punched Bonded Leather Insides
- Leather Lace
- Lacing Needle
- Patterns and Instructions

YOU WILL NEED:

- Rubber Cement
- Tools For Design



Distributed by Tandy Warehouse Co.
A Division of Tandy Crafts Inc.
Fort Worth, Texas 76107

KIT P



BACK A



TOP STRIP C

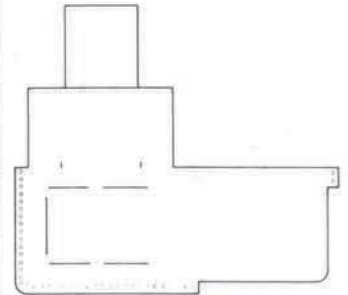

BILLFOLD INSIDE E



BILLFOLD INSIDE G



POCKET I

ASSEMBLY INSTRUCTIONS

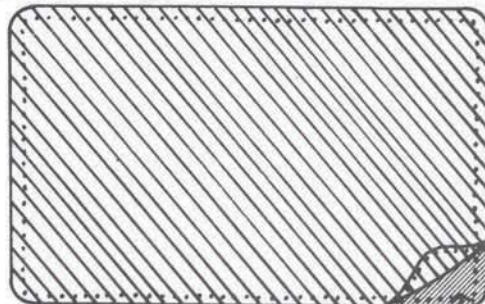

ROUGH SIDE BACK "A"

STEP 1. Cement lining "B" to back "A", flesh sides together.

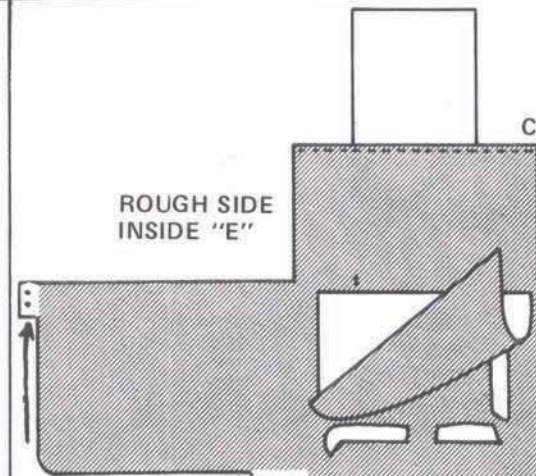

ROUGH SIDE INSIDE "E"

PARTS

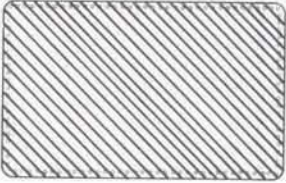

LINING B



TAB D

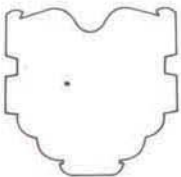

POCKET F

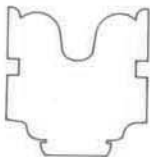

POCKET H

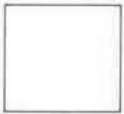

LINERS I

DOUBLE LOOP INSTRUCTIONS

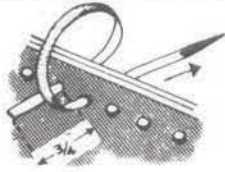

1. Beginning on front side of project, pull the needle and lace through the 1st hole. Leave about 3/4" of the lacing end and go on to lace the next hole.

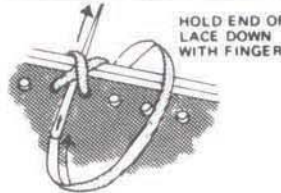

HOLD END OF LACE DOWN WITH FINGER

2. Pull the stitch tight, lacing over the end you left free. This forms a cross or "bight."

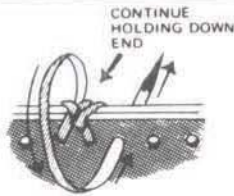

CONTINUE HOLDING DOWN END

3. Pull the stitch under the bight snug but not tight. Lace through the next hole.

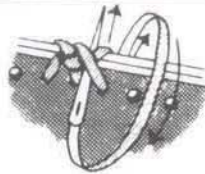

4. Follow the same procedure as in Steps 1 and 2 making a cross or bight. Once again go under the bight and pull the stitch snug.

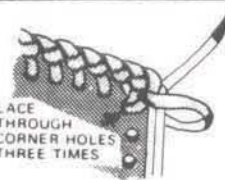

LACE THROUGH CORNER HOLES THREE TIMES

5. When lacing a corner, stitch it three times. Be sure to go through bight on corner stitches.

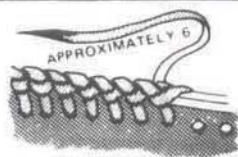

APPROXIMATELY 6

6. Lace until only 5" or 6" of lacing remain. You will now have to splice with a new length of lace.

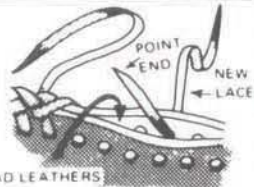

SPREAD LEATHERS

7. Insert new lacing down between leathers, 4 holes from lacing; pull out back side. Leave 3/4" of lacing between leather.

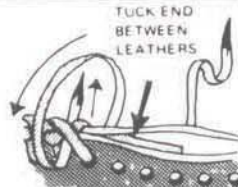

TUCK END BETWEEN LEATHERS

8. Tuck end of lace between leathers and continue lacing your project with the old lace.

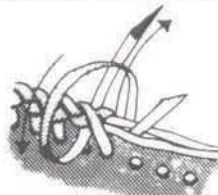

9. Pull the old lace up tight, cut off the end at an angle, allowing about 3/4" to remain. Attach needle to new lacing.

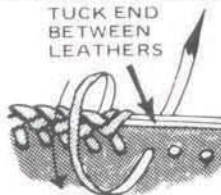

TUCK END BETWEEN LEATHERS

10. Tuck the end of the old lacing between the leathers and lace over it with the new lace so that it is caught and won't show.

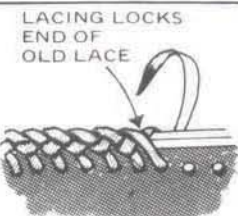

LACING LOCKS END OF OLD LACE

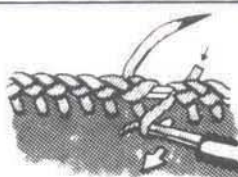

CEMENT

STEP 5. Turn billfold inside "E" over with rough side up. Cement rough side of one of the pocket liners "I" over tabs of pocket on rough side of billfold inside "E". Apply cement to white areas indicated on illustration.

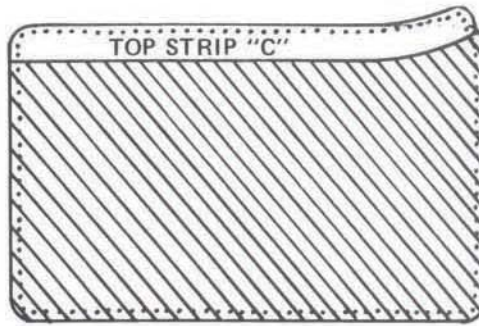

STEP 2. Apply cement to rough side of top cover strip "C", along punched edges. Apply cement to lined side of back "A" along top edge and sides which are covered by part "D". Let cement dry; then press pieces together, matching lacing holes carefully.

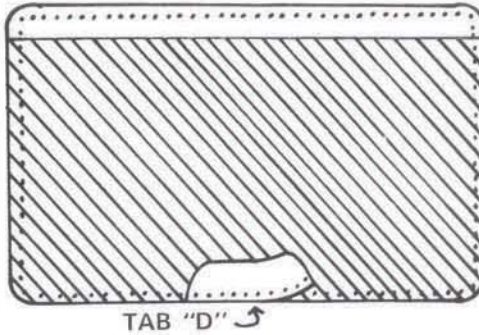

STEP 3. Cement rough side of punched edge of part "D" to lined side of bottom edge of back part "A". Match the first hole in part "D" with the 15th hole from the bottom left corner of part "A".

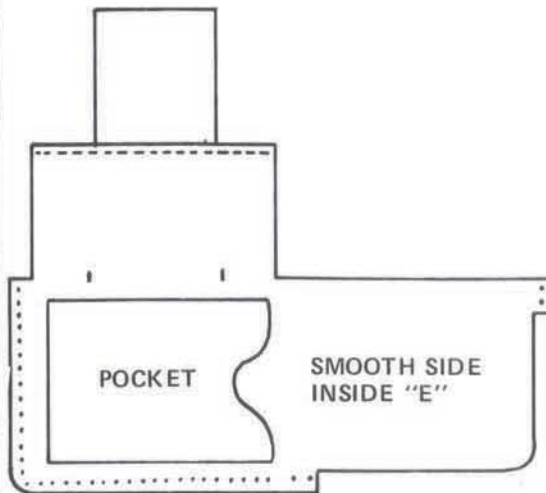

STEP 4. With smooth side of billfold inside "E" facing you, insert tabs in pocket "F" in slits in billfold inside "E".

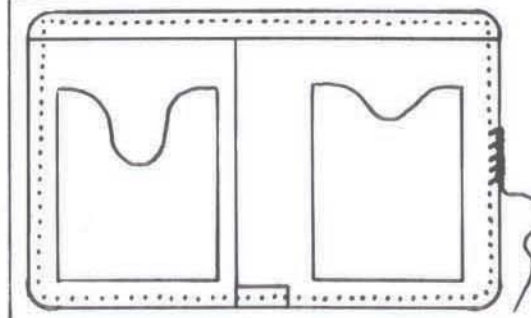
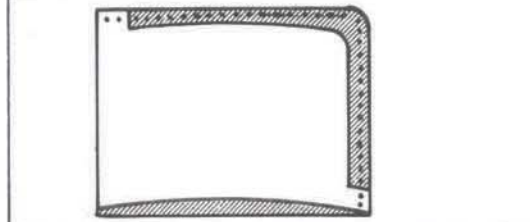
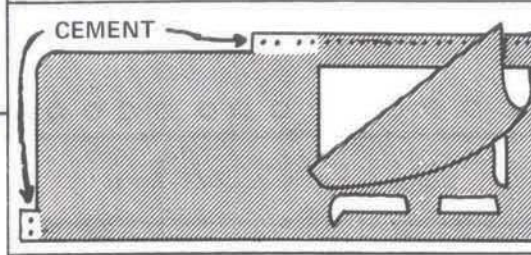
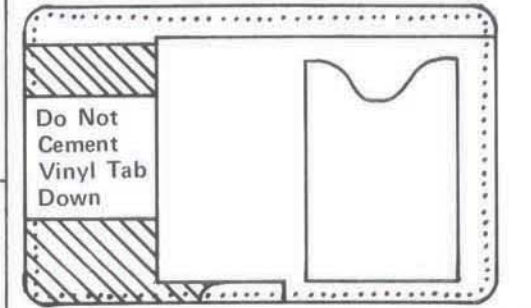
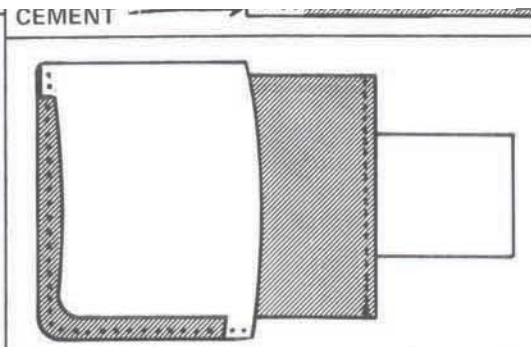

STEP 6. Fold billfold inside "E" over, rough side against rough side, align the holes and press the cemented areas together.

STEP 7. Cement billfold inside "E" to lined side of back "A" along the lacing holes with the lacing holes aligned.

STEP 8. With smooth side of billfold inside "G" facing you, insert tabs on packet "H" through slits in billfold inside "G".

STEP 9. Turn billfold inside "G" over with rough side up. Cement rough side of other pocket liner "I" over pocket tabs on rough side of billfold inside "G". Apply cement to white areas indicated on illustration.

← CEMENT

STEP 10. Fold billfold inside "G" over, rough side against rough side, align the holes and press the cemented areas together.

STEP 11. Apply cement to the rough side of inside "G" along lacing holes, and along the corresponding lacing holes of the lined side of back "A". Insert the vinyl tab of inside "E" through inside "G". Press the cemented areas of back "A" and inside "G" together with holes aligned with the vinyl tab between them. Lace billfold following the Double Loop Lacing Instructions on this page.

11. Continue lacing to starting point.

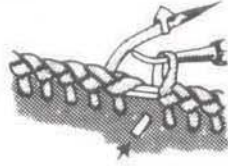

13. From back side pull the end of lace out of the hole.

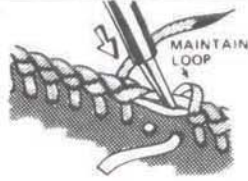

15. Push tool or needle down between leathers and hook it over the lace.

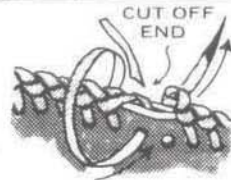

17. Cut off the end of the lace you have pulled out and tuck the end of the lace between the leathers. Lace through the next hole.

12. To tie off lacing, pull end of beginning lace free of stitches.

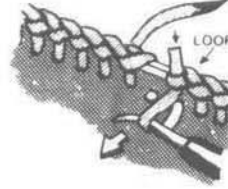

14. From front side, pull end of lace out of the loop.

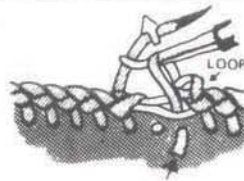

16. Pull end of lace out of hole and up between leathers. Two empty holes should appear on the front side; one on the back.

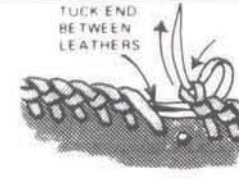

18. Pull stitch tight and lace up through loop from the back side. All holes on the back side should be filled.

19. Lace under the bight ... do not pull this stitch tight.



20. Carefully cross over as shown ... and push needle down through the loop.

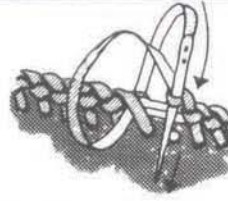

21. Pull needle through. Push laced edges together to adjust starting loops for easier completion.

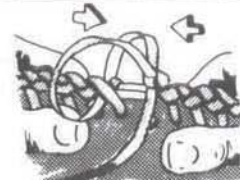

22. Pull any slack out of the first loop and adjust lacing with fingers to make all your stitches appear equal.

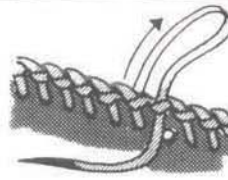

23. Pull the end of the lacing down tight. Make sure all stitches appear even and equally spaced.

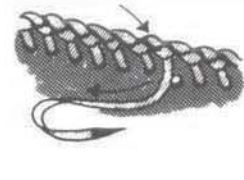

24. Push needle through the last hole as shown. Bring it up between the leathers and out between the lacing. Cut off the excess lace.

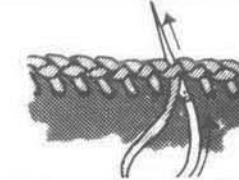

IF YOU ARE CUTTING FROM YOUR OWN LEATHER, USE THIS PATTERN FOR POCKET LINERS AND CUT 2 OUT OF LINING LEATHER.

IF YOU ARE CUTTING FROM YOUR OWN LEATHER, USE THIS PATTERN FOR INSIDE AND CUT 1 OUT OF LINING LEATHER.

IF YOU ARE CUTTING FROM YOUR OWN LEATHER, USE THIS PATTERN FOR TOP STRIP AND CUT 1 FROM LINING LEATHER.

IF YOU ARE CUTTING FROM YOUR OWN LEATHER, USE THIS PATTERN FOR INSIDE AND CUT 1 OUT OF LINING LEATHER.

THIS TAB IS MADE FROM VINYL AND STITCHED TO INSIDE.

IF YOU ARE CUTTING FROM YOUR OWN LEATHER, USE THIS PATTERN FOR TAB AND CUT 1 OUT OF LINING LEATHER.

IF YOU ARE CUTTING FROM YOUR OWN LEATHER, USE THIS PATTERN FOR POCKET AND CUT 1 OUT OF LINING LEATHER.

IF YOU ARE CUTTING FROM YOUR OWN LEATHER, USE THIS PATTERN FOR POCKET AND CUT 1 OUT OF LINING LEATHER.

No part of this or any other page may be reprinted without written permission.

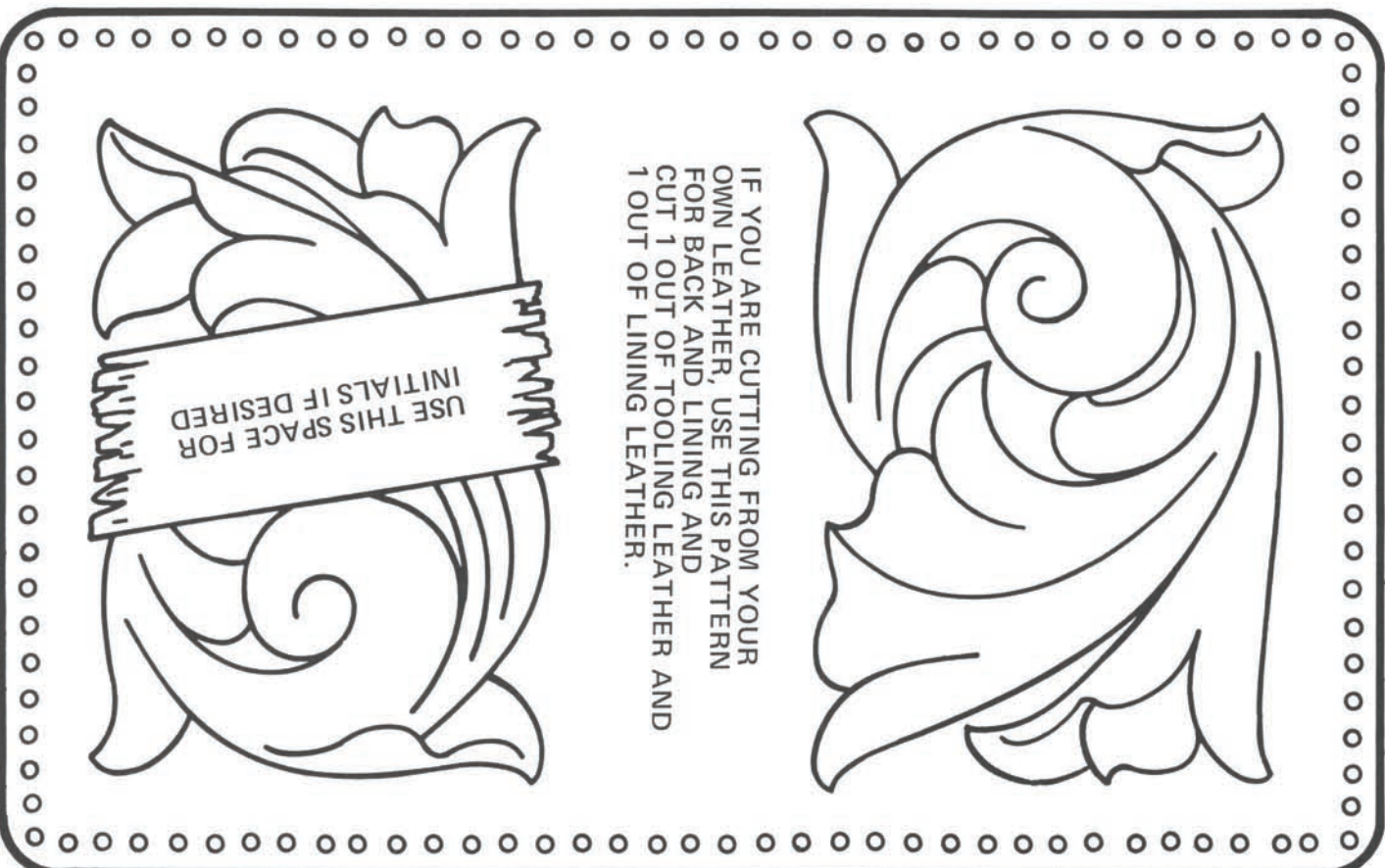
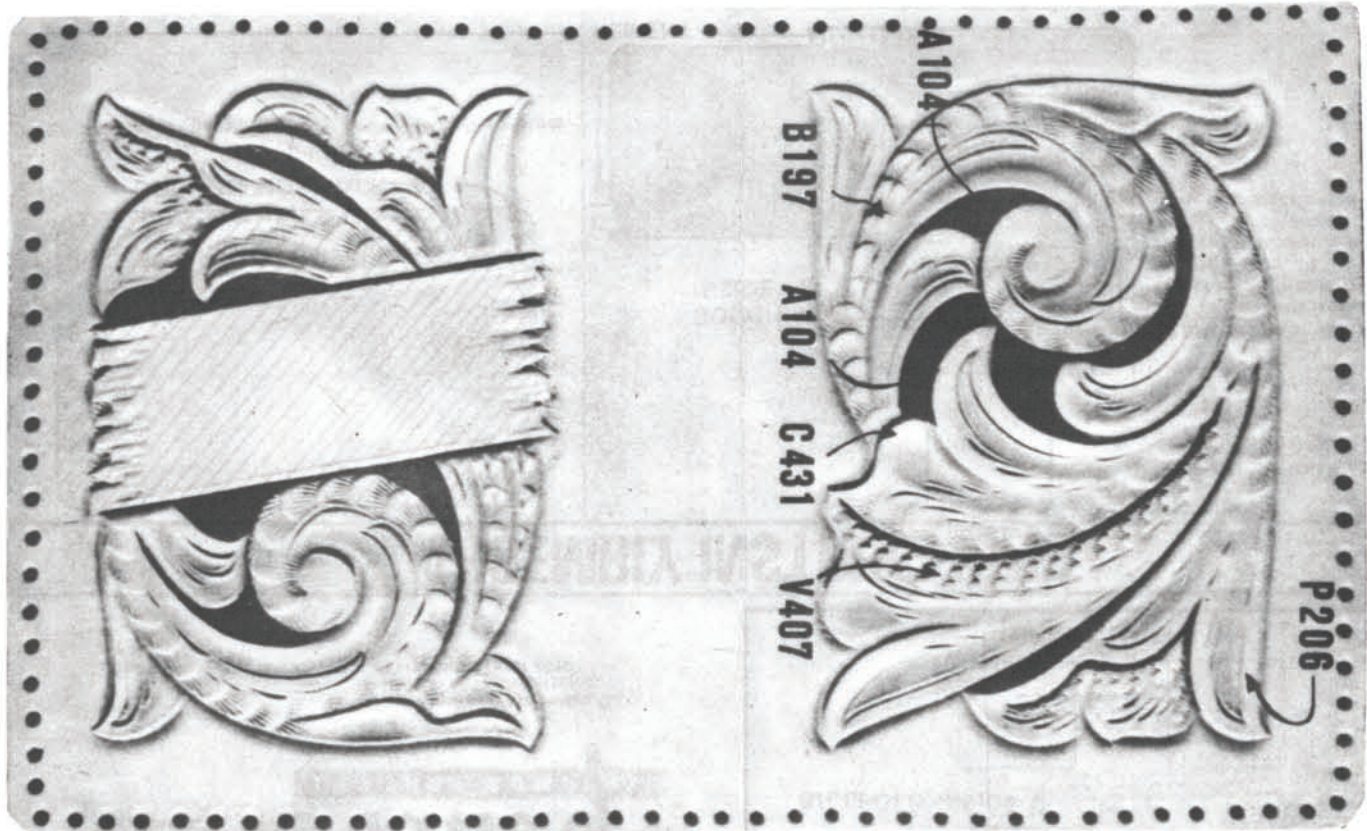



IF YOU ARE CUTTING FROM YOUR OWN LEATHER, USE THIS PATTERN FOR POCKET LINERS AND CUT 2 OUT OF LINING LEATHER.

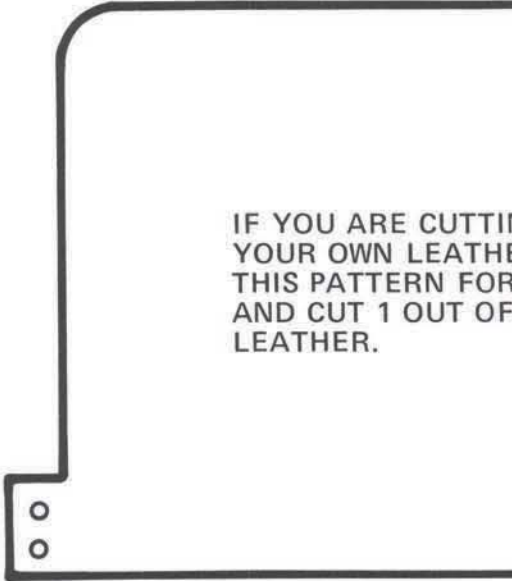

IF YOU ARE CUTTING FROM YOUR OWN LEATHER, USE THIS PATTERN FOR POCKET LINERS AND CUT 2 OUT OF LINING LEATHER.



IF YOU ARE CUTTING FROM YOUR OWN LEATHER, USE THIS PATTERN FOR TOP STRIP AND CUT 1 FROM LINING LEATHER.

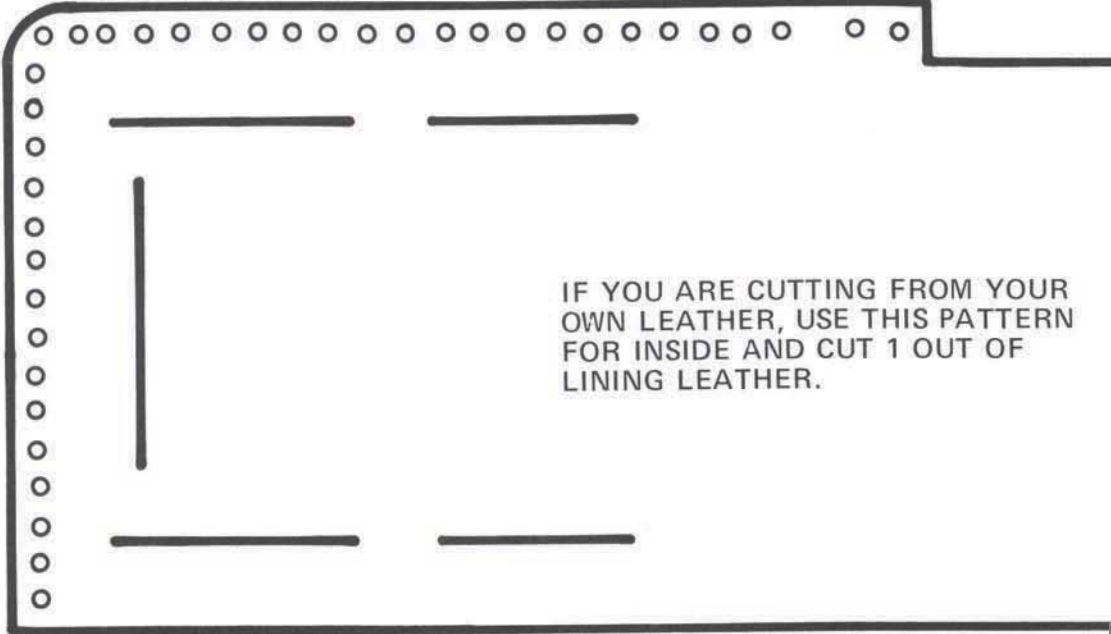

IF YOU ARE CUTTING FROM YOUR OWN LEATHER, USE THIS PATTERN FOR INSIDE AND CUT 1 OUT OF LINING LEATHER.

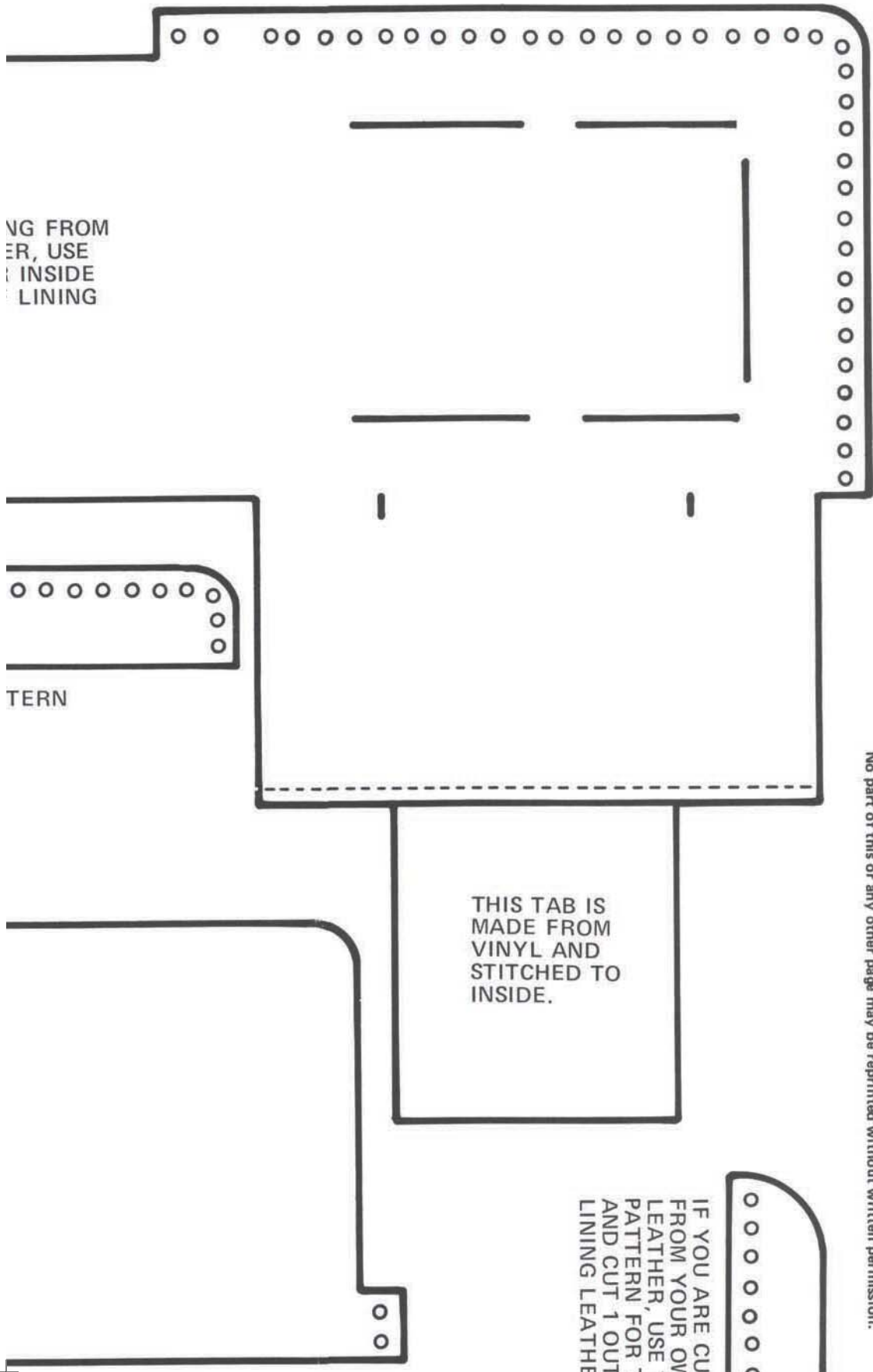

ING FROM
ER, USE
INSIDE
LINING

PATTERN

THIS TAB IS
MADE FROM
VINYL AND
STITCHED TO
INSIDE.

IF YOU ARE CUTTING
FROM YOUR OWN
LEATHER, USE THIS
PATTERN FOR CUTTING
AND CUT 1 OUT OF
LINING LEATHER

No part of this or any other page may be reprinted without written permission.

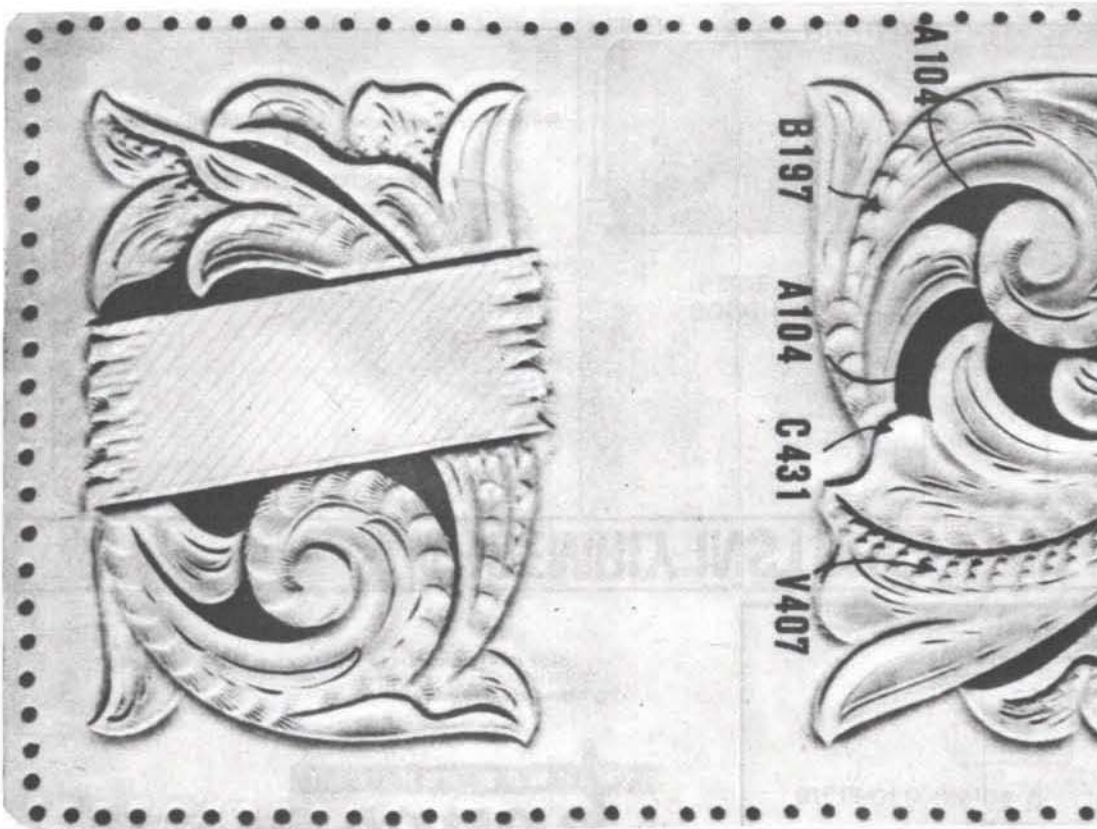

CUTTING
VIN
THIS
TAB
OF
ER.

IF YOU ARE CUTTING FROM
YOUR OWN LEATHER, USE THIS
PATTERN FOR POCKET AND CUT
1 OUT OF LINING LEATHER.

IF YOU ARE CUTTING FROM
YOUR OWN LEATHER, USE
THIS PATTERN FOR POCKET
AND CUT 1 OUT OF LINING
LEATHER.

