

# Jeans Design Long Wallet

©2023 by Eleana Workshop

5cm/2"

The pattern is designed for ISO A4 size paper.

Print 1:1, 100%,  
Actual size as shown below

Pattern comes with 4mm  
stitch line and 1mm hole punch

DIMENSIONS  
TEST  
BOX

5cm/2"

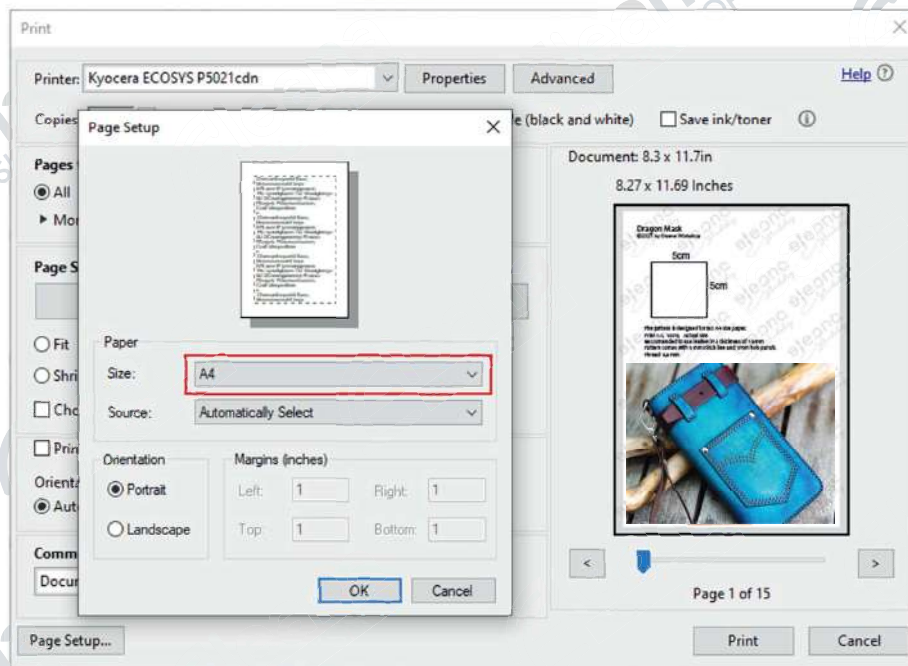
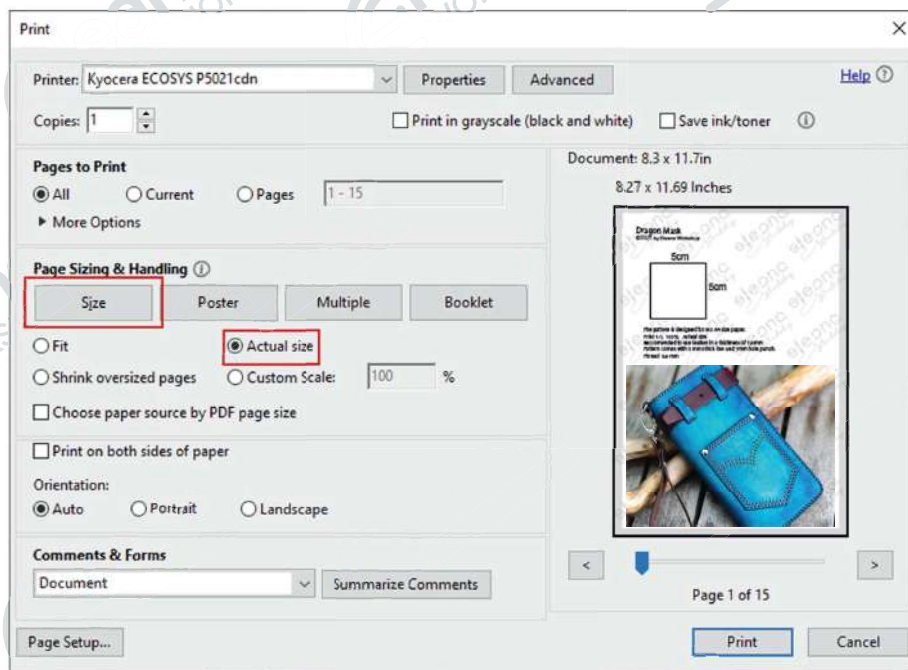

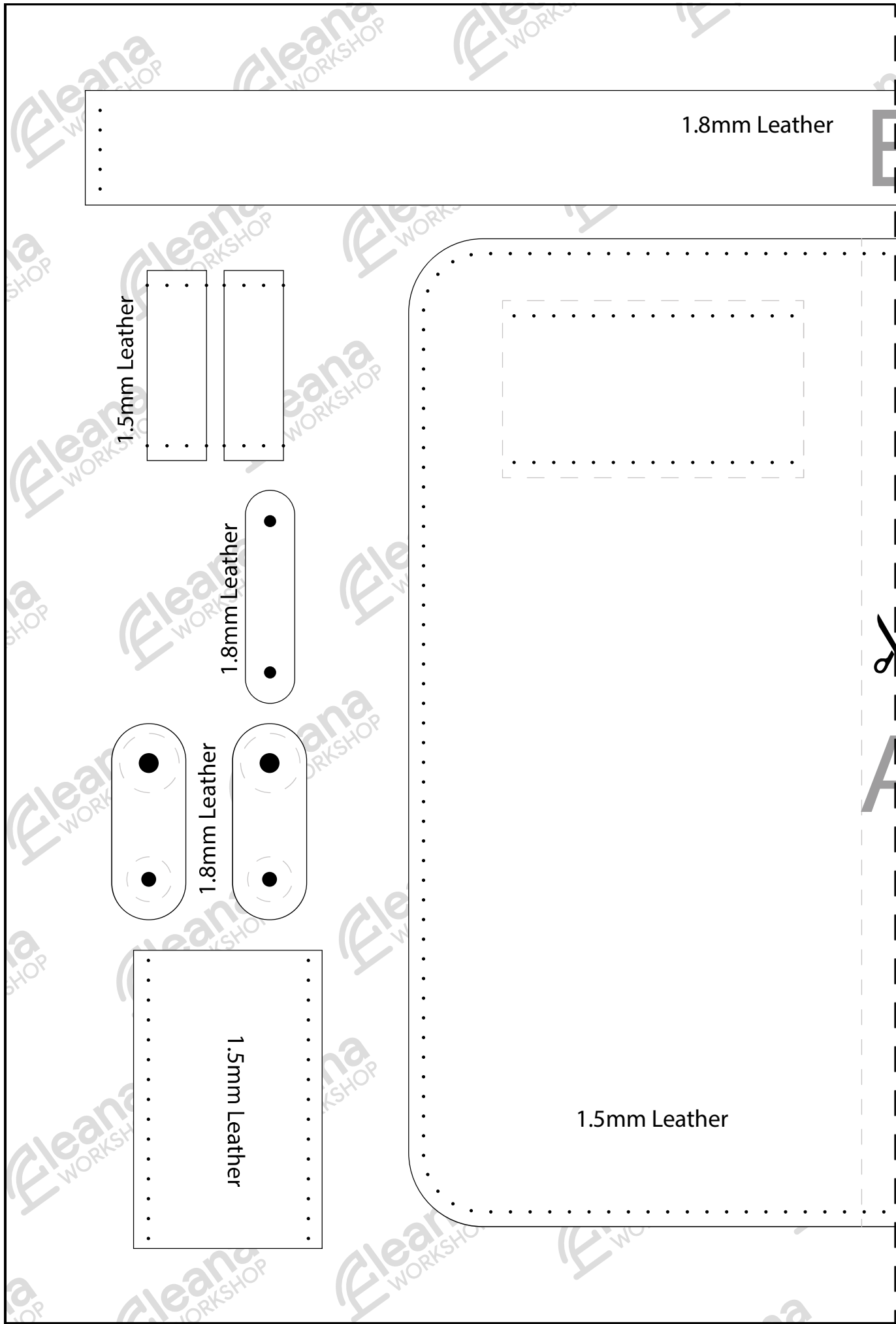

1.8mm Leather

1.5mm Leather

1.8mm Leather

1.8mm Leather

1.5mm Leather

1.5mm Leather



A

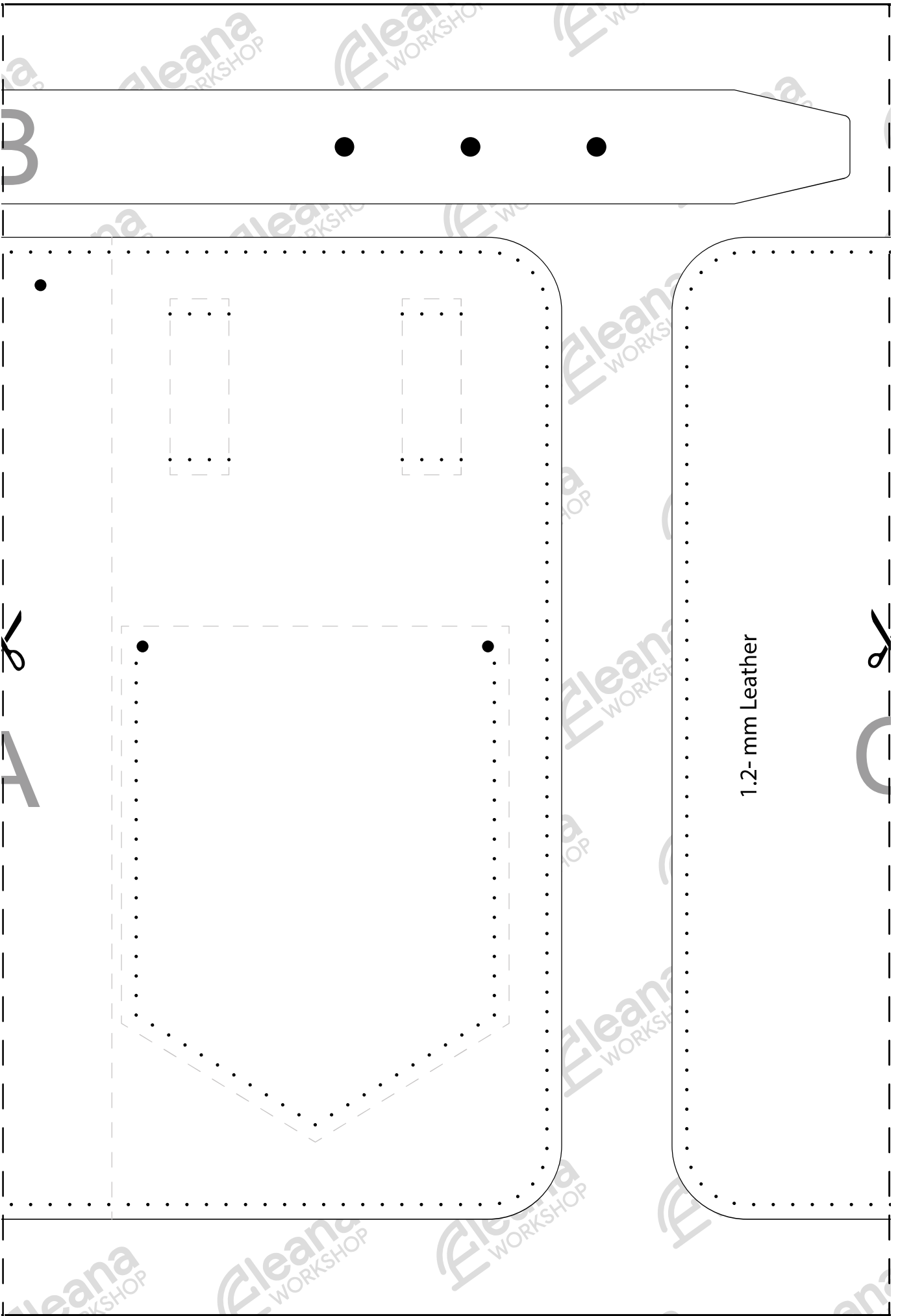

1.2- mm Leather

A

B



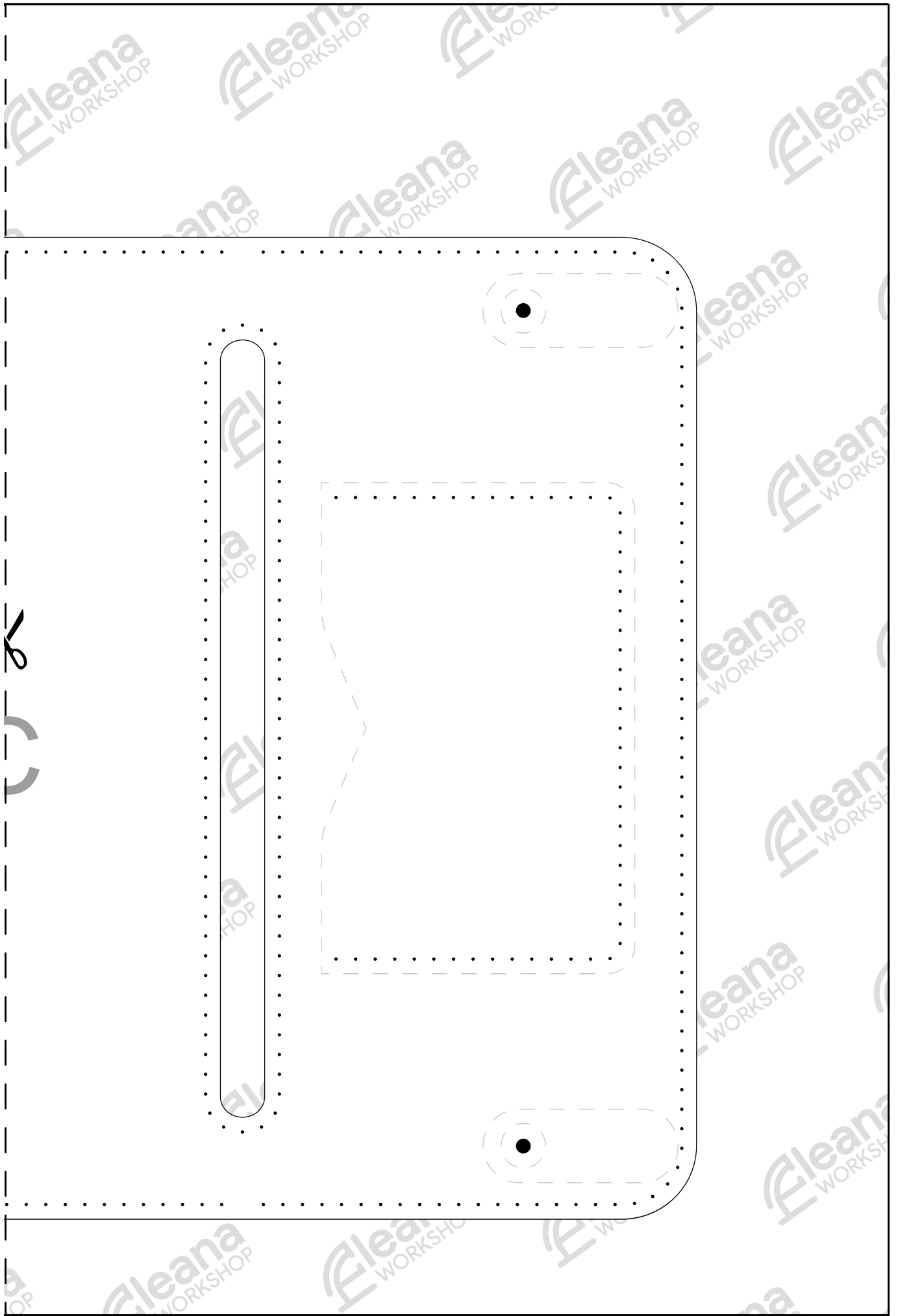

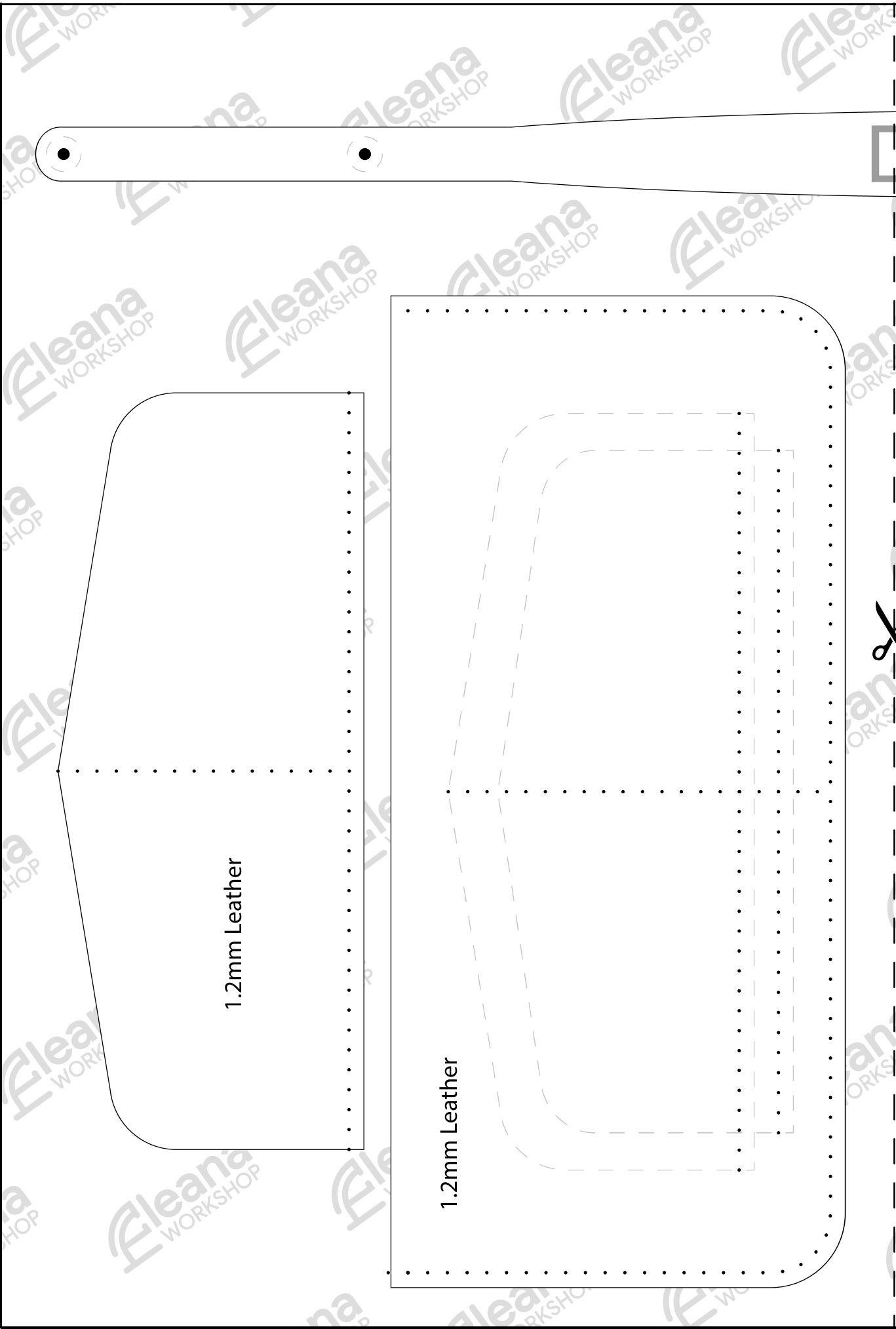

1.2mm Leather

1.2mm Leather



1.8-2.0mm Leather

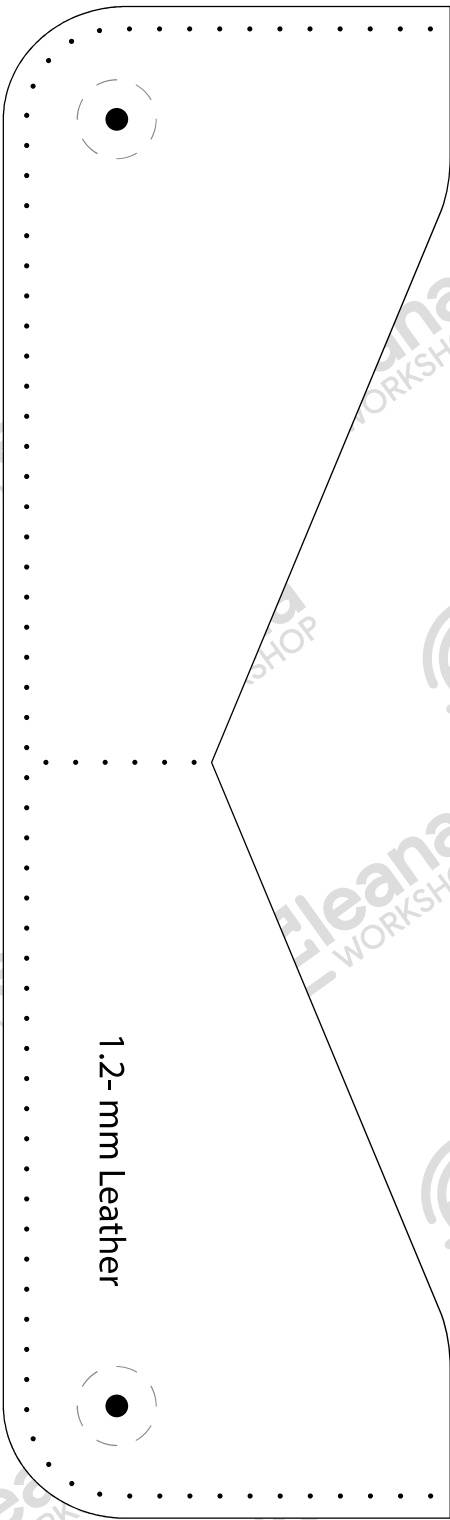

1.2- mm Leather

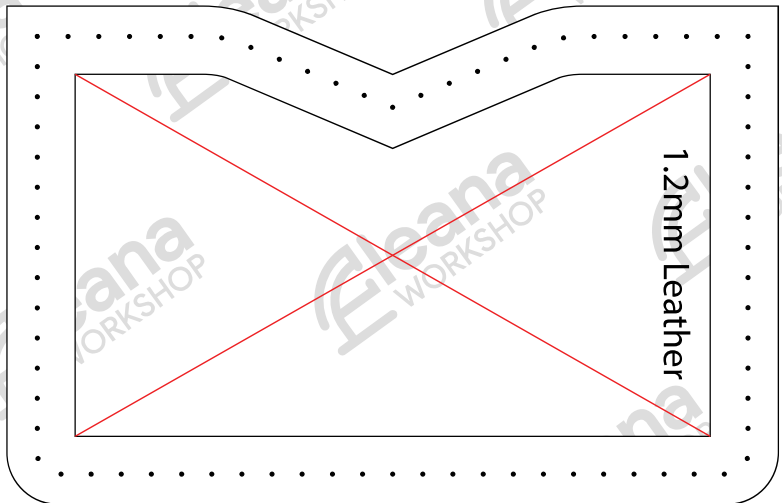

1.2mm Leather

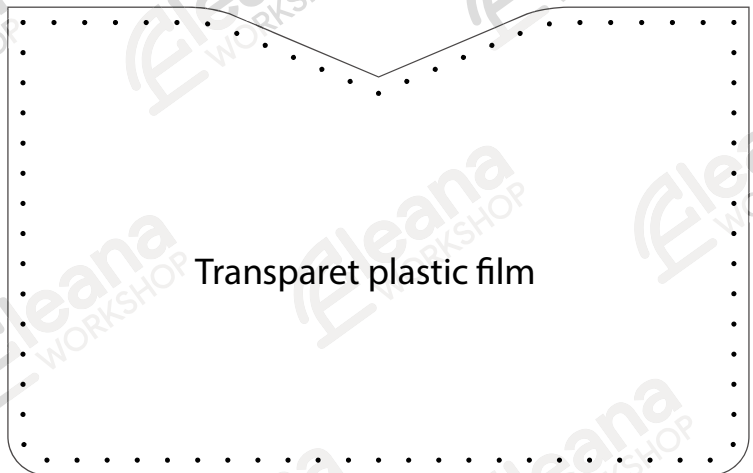

Transparet plastic film

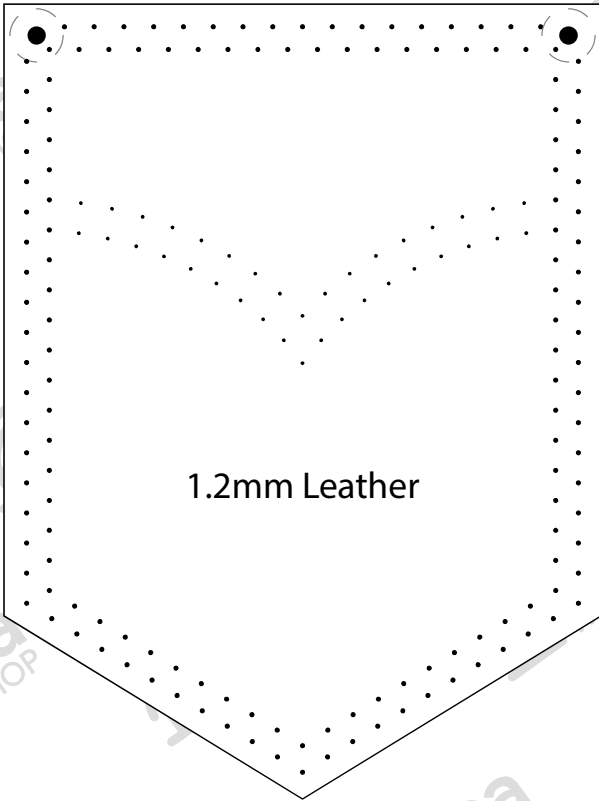

1.2mm Leather

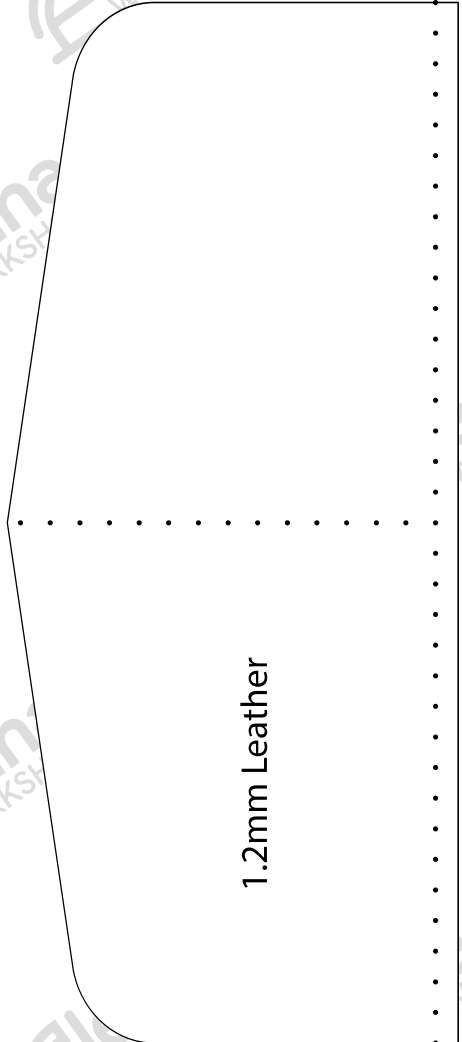

1.2mm Leather



# Jeans Design Long Wallet

©2023 by Eleana Workshop

## YOU WILL NEED:

- 57 cm x 22cm veg tanned leather, 1.2mm thick
- 27cm x 22cm veg tanned leather 1.5mm thick
- 38cm x 5cm veg tanned leather 1.8mm thick
- 0,6 mm polyester, waxed thread
- 12mm snap button
- 16cm zipper
- a piece of transparent sheet
- 1cm D ring
- 1 cm Swivel Lobster Clasp

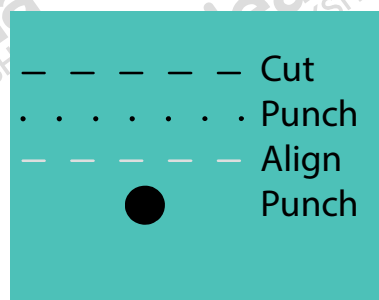

## VIDEO TUTORIAL:

<https://youtu.be/r8BxPVvGUIA>





# Jeans Design Long Wallet

© 2023 by Eleana Workshop

The pattern is designed for A4 size paper. Actual sizes are shown below. Pattern comes with 4mm stitch line and 1mm hole punch.

5cm/2"

**DIMENSIONS TEST BOX**

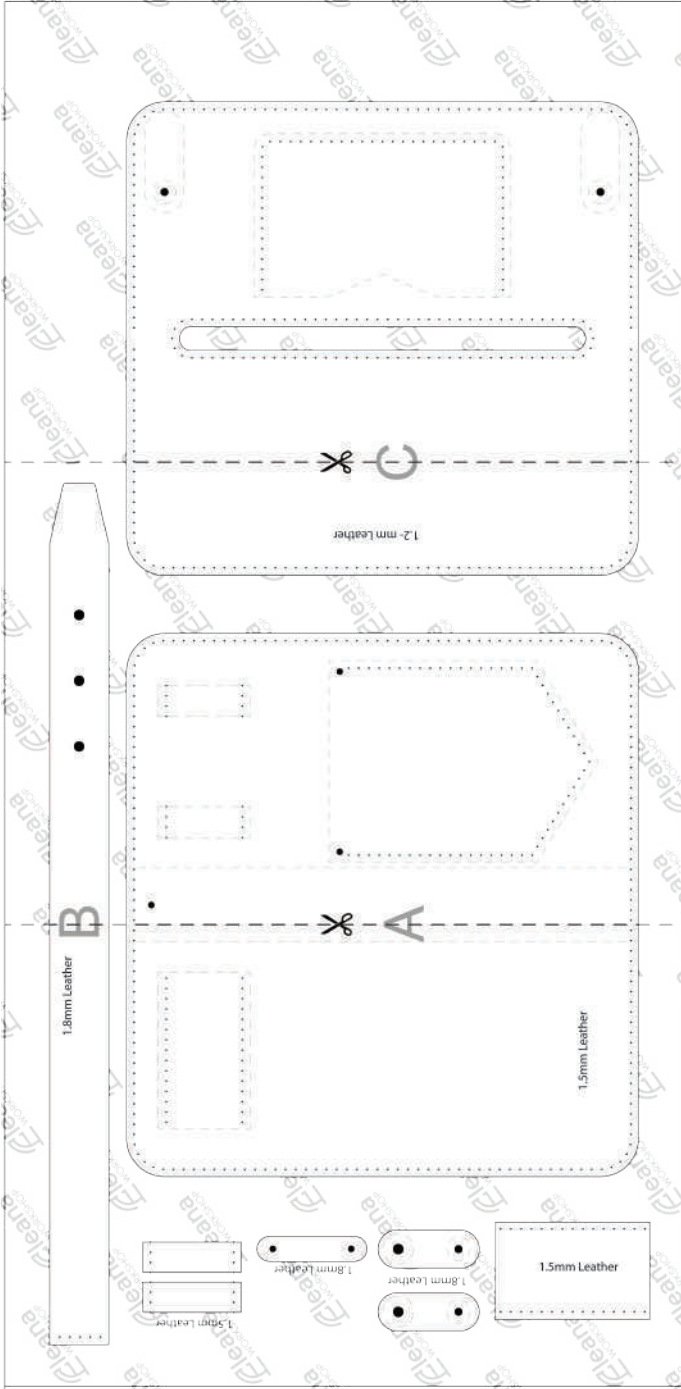
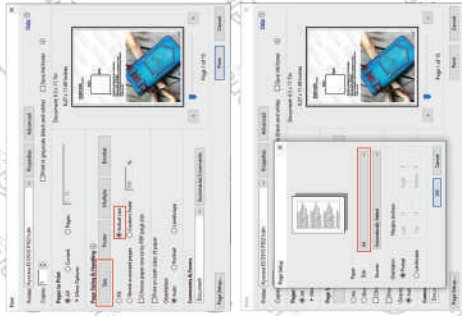

## Jeans Design Long Wallet

© 2023 by Eleana Workshop

### YOU WILL NEED:

- 57 cm x 22 cm vegetable leather 1.2mm thick
- 27 cm x 22 cm vegetable leather 1.5mm thick
- 38 cm x 5 cm vegetable leather 1.8mm thick
- 0.6 mm polyester waxed thread
- 12mm zipper button
- 16cm zipper
- padded transparent sheet
- 1mm hole punch
- 1cm Swivel Lobster Clasp



### VIDEO TUTORIAL:

coming soon

