

Test Page

Select A4 in the paper size printing menu
Choose "actual size" in the printing preferences
Make sure these dimensions are correct
before starting your pattern

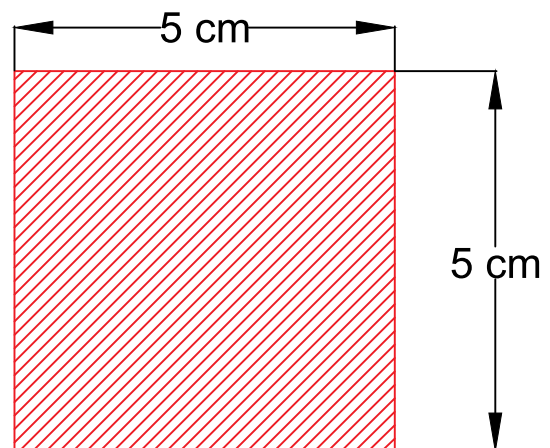

STUDIO ATTRACTIVE

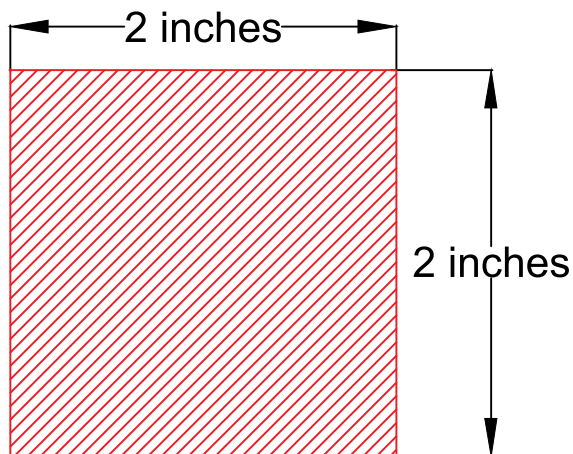

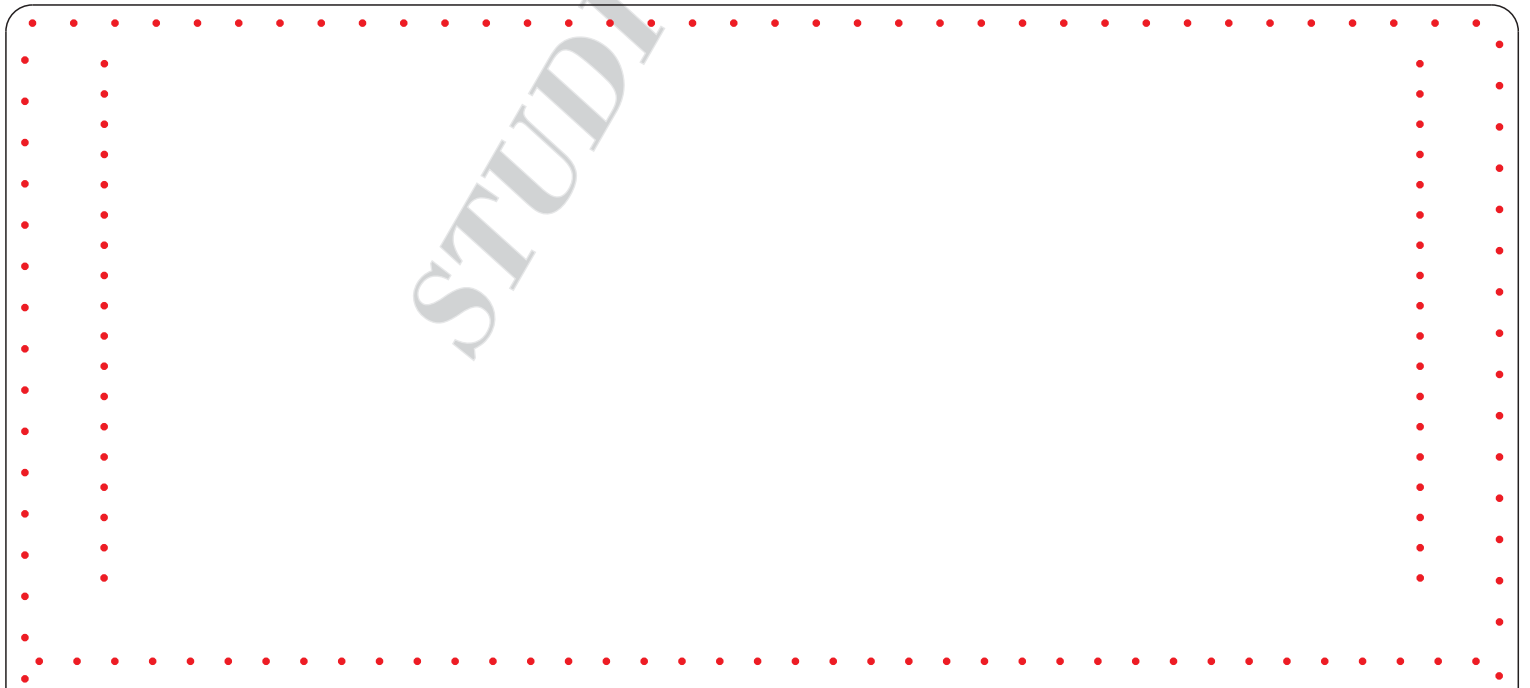
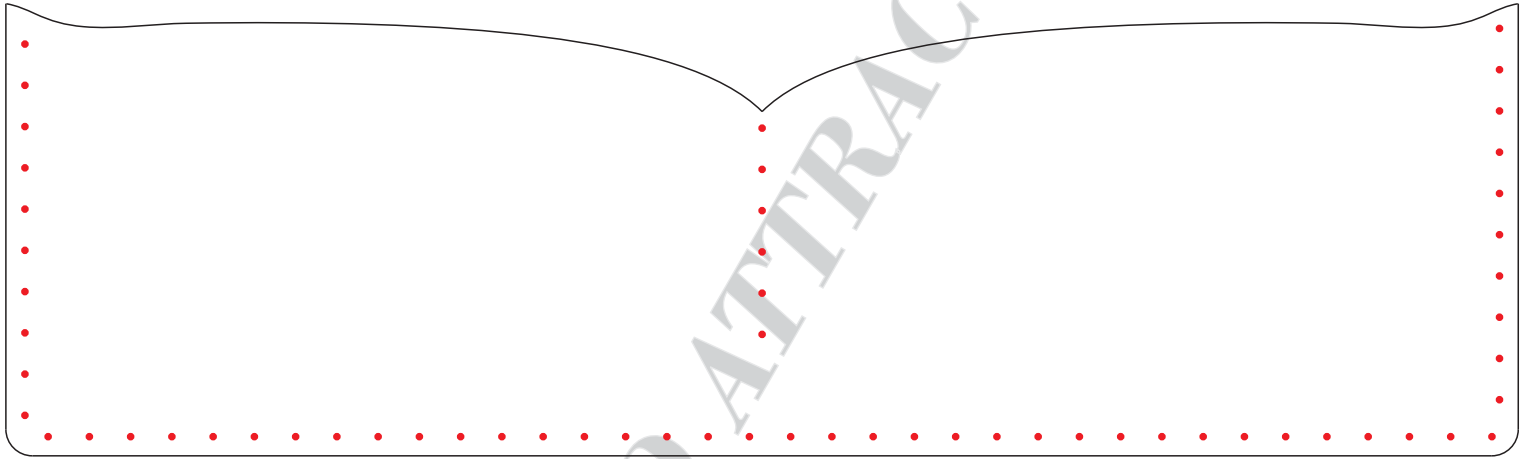
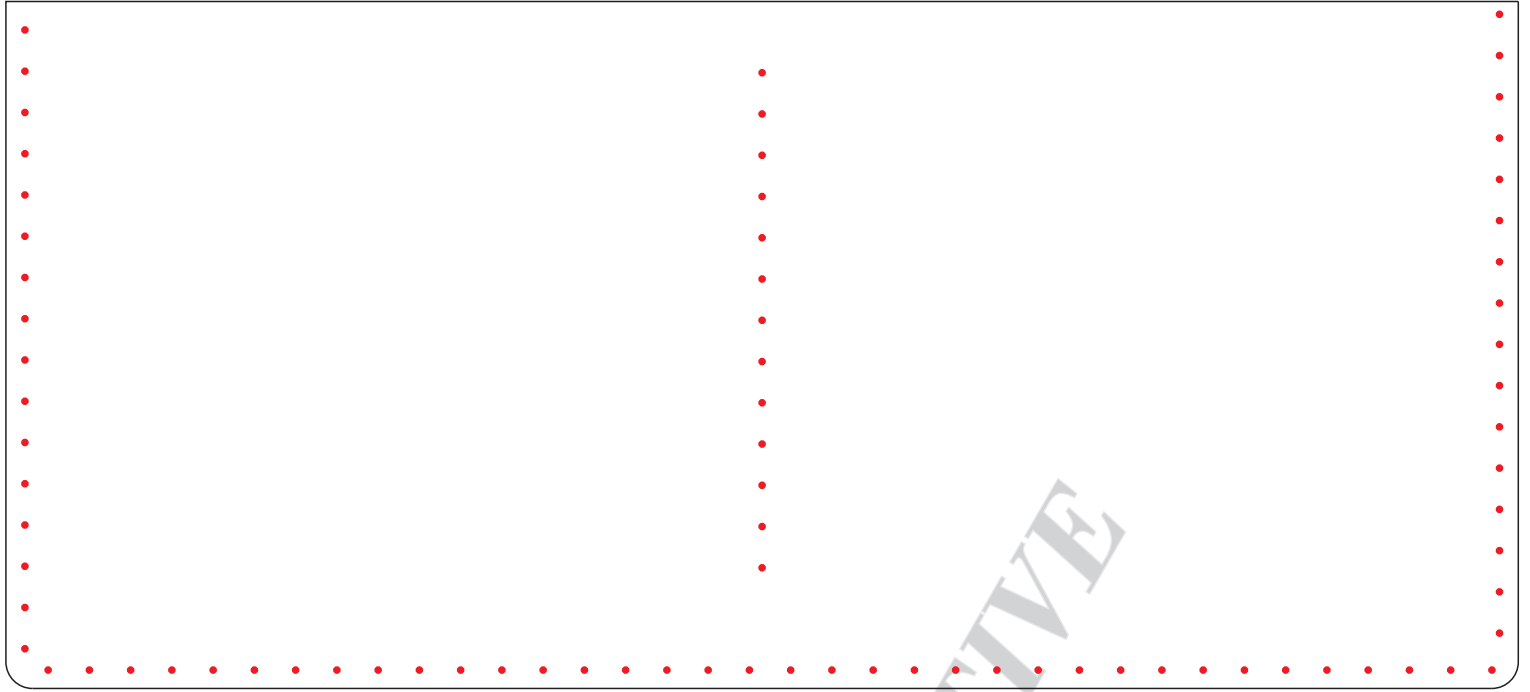

STUDIO ATTRACTIVE

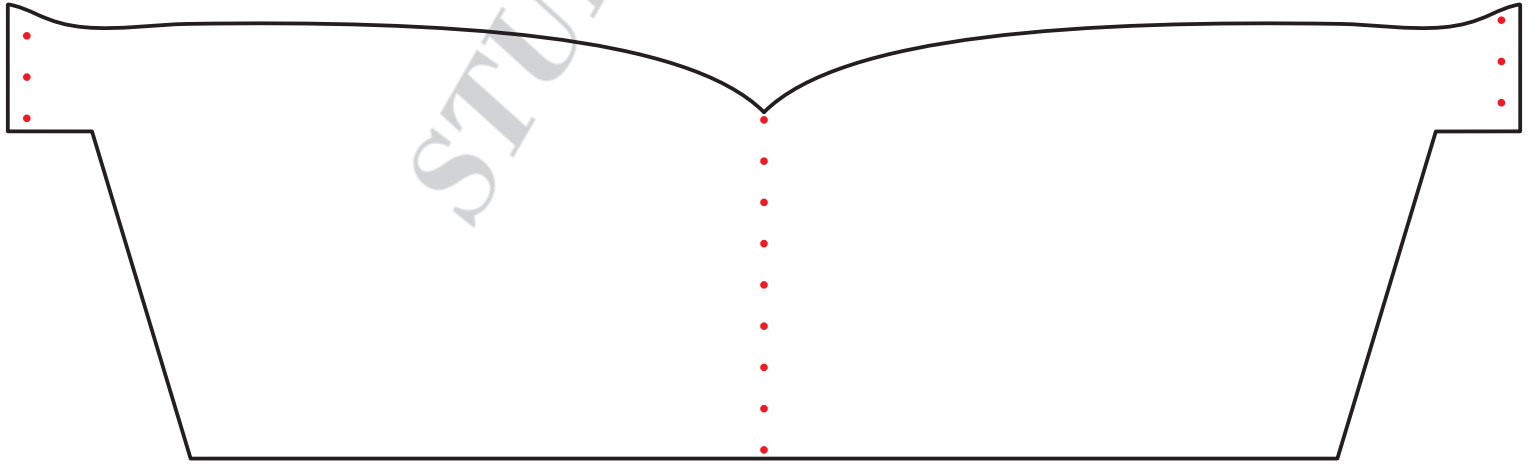
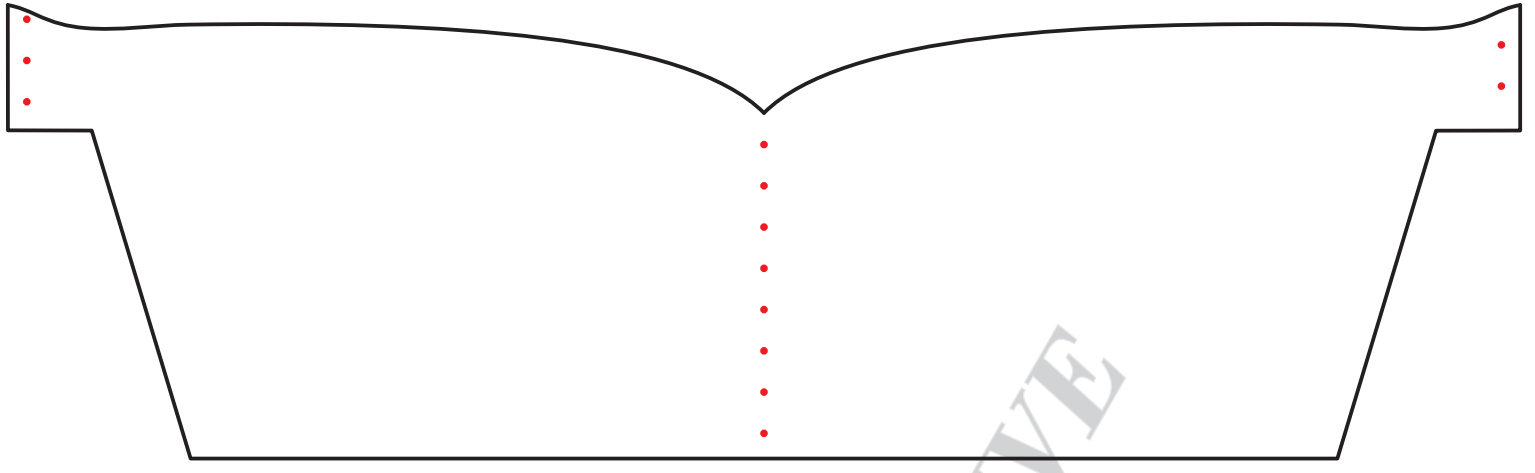

STUDIO ATTRACTIVE

